

Specification

Patented

- Part No. : **TG.30.8113W**
- Product Name : Apex White Hinged TG.30
Wideband 4G LTE Antenna
- Feature : LTE / GSM / CDMA /DCS /PCS / WCDMA / UMTS /
HSDPA / GPRS / EDGE /GPS /Wi-Fi
698-960MHz, 1575.42MHz, 1710-2700Mhz
Typical 70%+ Efficiency and 3dBi+ Peak Gain
Dipole Swivel Terminal Antenna
Hinged 90° termination with SMA(M) Connector
RoHS Compliant



1. Introduction

The hinged Apex TG.30 Ultra-Wideband Dipole LTE Antenna – is primarily designed for use with 4G LTE modules and devices that require the highest possible efficiency and peak gain to deliver best in class throughput on all major cellular (2g/3g/4g) bands worldwide for access points, terminals and routers. The antenna is a ground plane independent antenna with a SMA (M) connector and swivel mechanism that allows the antenna part to be rotated. The Apex exhibits high efficiency across the ultra wide band and is backward compatible with 2G and 3G cellular applications such as GSM, LTE, UMTS, WI-FI and even has GPS included for Assisted GPS and/or E911 applications. With very high efficiency on every cellular band globally it is an ideal solution for any device requiring high, reliable performance. It is also guaranteed to meet any type approval or carrier certification requirements from a RF standpoint. It is an omni-directional antenna and the radiation patterns display this and are stable across all bands.

It has a quality robust UV resistant housing for use with wireless terminals. The swivel and hinge mechanism allows the antenna part itself to be orientated in different directions and can help avoid touching off other antennas or objects close by as well as helping with isolation by orientating the antenna in different directions in MIMO systems for when other TG.30 antennas are present on the same device.

This patented antenna is available in White and Black versions. The antenna blade can swivel 90 degrees from the connector accommodating different installation environments. It is also available with Straight and Right Angle connectors.

2. Specification

Electrical Characteristics - Straight Antenna in Free Space					
Band Number		Frequency (MHz)	Efficiency (%)	Average Gain (dB)	Peak Gain (dBi)
1	Uplink	1920-1980	64	-1.9	4.5
	Downlink	2110-2170	69	-1.6	6.8
2	Uplink	1850-1910	60	-2.2	3.9
	Downlink	1930-1990	65	-1.9	4.6
3	Uplink	1710-1785	60	-2.2	3.2
	Downlink	1805 – 1880	60	-2.2	3.7
4	Uplink	1710-1755	59	-2.3	3.1
	Downlink	2110 – 2155	69	-1.6	6.8
5	Uplink	824-849	65	-1.9	1.5
	Downlink	869 – 894	54	-2.7	1.2
6	Uplink	875-885	54	-2.7	1.2
	Downlink	830-840	66	-1.8	1.5
7	Uplink	2500 – 2570	47	-3.3	4.1
	Downlink	2620 – 2690	43	-3.7	3.7
8	Uplink	880 – 915	49	-3.1	0.9
	Downlink	925 – 960	46	-3.4	0.8
9	Uplink	1749.9 – 1784.9	60	-2.2	3.4
	Downlink	1844.9 – 1879.9	60	-2.2	3.8
10	Uplink	1710 - 1770	59	-2.3	3.1
	Downlink	2110-2170	69	-1.6	6.8
11	Uplink	1427.9 – 1447.9	19	-7.2	-2.8
	Downlink	1475.9 – 1495.9	26	-5.8	-0.6
12	Uplink	699 – 716	58	-2.4	0.3
	Downlink	729 – 746	68	-1.7	1.4
13	Uplink	777 – 787	74	-1.3	2.1
	Downlink	746 – 756	71	-1.5	1.7
14	Uplink	788 – 798	75	-1.2	2.2
	Downlink	758 – 768	72	-1.4	1.9
17	Uplink	704 – 716	58	-2.4	0.3
	Downlink	734 – 746	68	-1.7	1.4
18	Uplink	815 – 830	73	-1.4	2.1

	Downlink	860 – 875	55	-2.6	1.2
19	Uplink	830 – 845	63	-2	1.4
	Downlink	875 – 890	54	-2.7	1.2
20	Uplink	832 – 862	61	-2.1	1.3
	Downlink	791 – 821	75	-1.3	2.2
21	Uplink	1447.9 – 1462.9	22	-6.5	-1.6
	Downlink	1495.9 – 1510.9	26	-5.9	-1.2
22	Uplink	3410 – 3490	43	-3.7	3.5
	Downlink	3510 – 3590	48	-3.1	3.6
23	Uplink	2000-2020	73	-1.4	5.2
	Downlink	2180-2200	69	-1.6	7
24	Uplink	1626.5-1660.5	58	-2.3	2
	Downlink	1525-1559	59	-2.3	2.2
25	Uplink	1850 – 1915	60	-2.2	3.9
	Downlink	1930 – 1995	66	-1.8	4.6
26	Uplink	814 – 849	68	-1.7	1.7
	Downlink	859 – 894	55	-2.6	1.2
27	Uplink	807 – 824	75	-1.3	2.2
	Downlink	852 – 869	57	-2.5	1.1
28	Uplink	703 – 748	63	-2	0.8
	Downlink	758 – 803	74	-1.3	2.1
29	Downlink	717 – 728	63	-2	0.8
30	Uplink	2305 – 2315	62	-2.1	4.5
	Downlink	2350 – 2360	62	-2.1	3.2
32	Downlink	1452 – 1496	25	-6.1	-1
33		1900-1920	61	-2.1	4.2
34		2010-2025	75	-1.2	5.4
35		1850-1910	60	-2.2	3.9
36		1930-1990	65	-1.9	4.6
37		1910-1930	63	-2	4.3
38		2570 – 2620	44	-3.5	3.9
39		1880 – 1920	60	-2.2	4
40		2300 – 2400	60	-2.3	3.4
41		2496 – 2690	45	-3.5	3.9
42		3400 – 3600	46	-3.4	3.6

Electrical Characteristics - Bent Antenna in Free Space						
Band Number		Frequency (MHz)	Efficiency (%)	Average Gain (dB)	Peak Gain (dBi)	
1	Uplink	1920-1980	72	-1.5	4.7	
	Downlink	2110-2170	74	-1.3	7	
2	Uplink	1850-1910	68	-1.7	4	
	Downlink	1930-1990	73	-1.4	4.8	
3	Uplink	1710-1785	69	-1.6	3.1	
	Downlink	1805 – 1880	69	-1.6	3.7	
4	Uplink	1710-1755	68	-1.7	2.9	
	Downlink	2110 – 2155	74	-1.3	7	
5	Uplink	824-849	67	-1.8	1.5	
	Downlink	869 – 894	54	-2.7	1.2	
6	Uplink	875-885	54	-2.7	1.2	
	Downlink	830-840	68	-1.7	1.5	
7	Uplink	2500 – 2570	70	-1.5	4.3	
	Downlink	2620 – 2690	65	-1.9	4.5	
8	Uplink	880 – 915	49	-3.2	0.9	
	Downlink	925 – 960	44	-3.6	0.5	
9	Uplink	1749.9 – 1784.9	69	-1.6	3.3	
	Downlink	1844.9 – 1879.9	68	-1.6	3.9	
10	Uplink	1710 - 1770	68	-1.7	3	
	Downlink	2110-2170	74	-1.3	7	
11	Uplink	1427.9 – 1447.9	24	-6.2	-1.5	
	Downlink	1475.9 – 1495.9	42	-3.8	1.3	
12	Uplink	699 – 716	62	-2.1	1	
	Downlink	729 – 746	70	-1.5	1.5	
13	Uplink	777 – 787	75	-1.3	2.2	
	Downlink	746 – 756	72	-1.4	1.8	
14	Uplink	788 – 798	76	-1.2	2.3	
	Downlink	758 – 768	73	-1.4	1.9	
17	Uplink	704 – 716	62	-2.1	1	
	Downlink	734 – 746	70	-1.5	1.5	
18	Uplink	815 – 830	74	-1.3	2.1	
	Downlink	860 – 875	56	-2.5	1.2	

19	Uplink	830 – 845	64	-1.9	1.4
	Downlink	875 – 890	54	-2.7	1.2
20	Uplink	832 – 862	63	-2	1.3
	Downlink	791 – 821	76	-1.2	2.3
21	Uplink	1447.9 – 1462.9	30	-5.2	-0.2
	Downlink	1495.9 – 1510.9	43	-3.7	1.4
22	Uplink	3410 – 3490	48	-3.2	4.5
	Downlink	3510 – 3590	56	-2.5	5.4
23	Uplink	2000-2020	80	-1	5.4
	Downlink	2180-2200	74	-1.3	7.1
24	Uplink	1626.5-1660.5	68	-1.7	2.4
	Downlink	1525-1559	69	-1.7	1.8
25	Uplink	1850 – 1915	68	-1.7	4.1
	Downlink	1930 – 1995	73	-1.4	4.8
26	Uplink	814 – 849	69	-1.6	1.7
	Downlink	859 – 894	55	-2.6	1.2
27	Uplink	807 – 824	76	-1.2	2.3
	Downlink	852 – 869	57	-2.4	1.1
28	Uplink	703 – 748	66	-1.8	1.2
	Downlink	758 – 803	75	-1.3	2.1
29	Downlink	717 – 728	65	-1.8	1.2
30	Uplink	2305 – 2315	66	-1.8	4.5
	Downlink	2350 – 2360	73	-1.4	4
32	Downlink	1452 – 1496	37	-4.4	0.7
33		1900-1920	68	-1.7	4.3
34		2010-2025	83	-0.8	5.6
35		1850-1910	68	-1.7	4
36		1930-1990	73	-1.4	4.8
37		1910-1930	70	-1.5	4.5
38		2570 – 2620	69	-1.6	4.7
39		1880 – 1920	67	-1.7	4.2
40		2300 – 2400	69	-1.6	4.3
41		2496 – 2690	68	-1.7	4.5
42		3400 – 3600	52	-2.8	5

Electrical Characteristics - Straight Antenna on Ground Plane Edge					
Band Number		Frequency (MHz)	Efficiency (%)	Average Gain (dB)	Peak Gain (dBi)
1	Uplink	1920-1980	74	-1.3	5.9
	Downlink	2110-2170	67	-1.7	7
2	Uplink	1850-1910	75	-1.3	5.6
	Downlink	1930-1990	74	-1.3	5.9
3	Uplink	1710-1785	74	-1.3	4.8
	Downlink	1805 – 1880	77	-1.1	5.6
4	Uplink	1710-1755	73	-1.4	4.6
	Downlink	2110 – 2155	67	-1.8	6.9
5	Uplink	824-849	64	-1.9	2.4
	Downlink	869 – 894	63	-2	3.2
6	Uplink	875-885	63	-2	3.2
	Downlink	830-840	63	-2	2.2
7	Uplink	2500 – 2570	58	-2.3	5
	Downlink	2620 – 2690	69	-1.6	5.8
8	Uplink	880 – 915	64	-2	3.7
	Downlink	925 – 960	66	-1.8	4.2
9	Uplink	1749.9 – 1784.9	76	-1.2	5.1
	Downlink	1844.9 – 1879.9	76	-1.2	5.6
10	Uplink	1710 - 1770	73	-1.3	4.7
	Downlink	2110-2170	67	-1.7	7
11	Uplink	1427.9 – 1447.9	36	-4.4	1
	Downlink	1475.9 – 1495.9	33	-4.8	1.8
12	Uplink	699 – 716	61	-2.2	1.1
	Downlink	729 – 746	73	-1.4	2.2
13	Uplink	777 – 787	75	-1.2	2.4
	Downlink	746 – 756	77	-1.2	2.4
14	Uplink	788 – 798	77	-1.2	2.6
	Downlink	758 – 768	77	-1.2	2.4
17	Uplink	704 – 716	61	-2.2	1.1
	Downlink	734 – 746	73	-1.4	2.2
18	Uplink	815 – 830	69	-1.6	2.5
	Downlink	860 – 875	63	-2	2.9
19	Uplink	830 – 845	63	-2	2.4

	Downlink	875 – 890	63	-2	3.2
20	Uplink	832 – 862	63	-2	2.4
	Downlink	791 – 821	74	-1.3	2.7
21	Uplink	1447.9 – 1462.9	39	-4.1	1.7
	Downlink	1495.9 – 1510.9	29	-5.3	0.8
22	Uplink	3410 – 3490	53	-2.8	4.1
	Downlink	3510 – 3590	69	-1.6	4.7
23	Uplink	2000-2020	76	-1.2	6.2
	Downlink	2180-2200	72	-1.4	7.5
24	Uplink	1626.5-1660.5	66	-1.8	3.4
	Downlink	1525-1559	66	-1.8	3.3
25	Uplink	1850 – 1915	75	-1.3	5.7
	Downlink	1930 – 1995	74	-1.3	5.9
26	Uplink	814 – 849	66	-1.8	2.5
	Downlink	859 – 894	63	-2	3
27	Uplink	807 – 824	71	-1.5	2.7
	Downlink	852 – 869	64	-1.9	2.7
28	Uplink	703 – 748	67	-1.8	1.6
	Downlink	758 – 803	76	-1.2	2.4
29	Downlink	717 – 728	69	-1.6	1.7
30	Uplink	2305 – 2315	74	-1.3	5.7
	Downlink	2350 – 2360	67	-1.8	4
32	Downlink	1452 – 1496	36	-4.4	1.8
33		1900-1920	74	-1.3	5.8
34		2010-2025	77	-1.1	6.4
35		1850-1910	75	-1.3	5.6
36		1930-1990	74	-1.3	5.9
37		1910-1930	75	-1.3	5.9
38		2570 – 2620	62	-2.1	5.3
39		1880 – 1920	74	-1.3	5.7
40		2300 – 2400	65	-1.9	4.5
41		2496 – 2690	63	-2	5.4
42		3400 – 3600	60	-2.3	4.3

Electrical Characteristics - Bent Antenna on Ground Plane Edge					
Band Number		Frequency (MHz)	Efficiency (%)	Average Gain (dB)	Peak Gain (dBi)
1	Uplink	1920-1980	72	-1.4	5
	Downlink	2110-2170	68	-1.7	6.8
2	Uplink	1850-1910	71	-1.5	4.9
	Downlink	1930-1990	73	-1.4	4.9
3	Uplink	1710-1785	68	-1.7	4.4
	Downlink	1805 – 1880	70	-1.6	4.6
4	Uplink	1710-1755	67	-1.8	4.2
	Downlink	2110 – 2155	68	-1.7	6.7
5	Uplink	824-849	59	-2.3	1.3
	Downlink	869 – 894	56	-2.5	0.6
6	Uplink	875-885	56	-2.5	0.6
	Downlink	830-840	58	-2.4	1.2
7	Uplink	2500 – 2570	50	-3	2.2
	Downlink	2620 – 2690	62	-2.1	4
8	Uplink	880 – 915	54	-2.7	0.2
	Downlink	925 – 960	53	-2.8	0
9	Uplink	1749.9 – 1784.9	69	-1.6	4.6
	Downlink	1844.9 – 1879.9	70	-1.5	4.7
10	Uplink	1710 - 1770	67	-1.7	4.3
	Downlink	2110-2170	68	-1.7	6.8
11	Uplink	1427.9 – 1447.9	28	-5.5	-0.4
	Downlink	1475.9 – 1495.9	40	-4	0.1
12	Uplink	699 – 716	67	-1.7	1.2
	Downlink	729 – 746	74	-1.3	1.9
13	Uplink	777 – 787	69	-1.6	2
	Downlink	746 – 756	75	-1.3	2
14	Uplink	788 – 798	70	-1.6	1.9
	Downlink	758 – 768	73	-1.3	2
17	Uplink	704 – 716	67	-1.7	1.2
	Downlink	734 – 746	74	-1.3	1.9
18	Uplink	815 – 830	62	-2.1	1.5
	Downlink	860 – 875	57	-2.4	0.9
19	Uplink	830 – 845	58	-2.4	1.2

	Downlink	875 – 890	56	-2.5	0.6
20	Uplink	832 – 862	58	-2.3	1.2
	Downlink	791 – 821	67	-1.7	1.8
21	Uplink	1447.9 – 1462.9	37	-4.4	0.5
	Downlink	1495.9 – 1510.9	37	-4.4	-0.4
22	Uplink	3410 – 3490	50	-3.1	6.4
	Downlink	3510 – 3590	64	-1.9	8
23	Uplink	2000-2020	74	-1.3	5.2
	Downlink	2180-2200	72	-1.4	7.2
24	Uplink	1626.5-1660.5	60	-2.2	3.6
	Downlink	1525-1559	65	-1.9	3.1
25	Uplink	1850 – 1915	71	-1.5	4.9
	Downlink	1930 – 1995	72	-1.4	4.9
26	Uplink	814 – 849	61	-2.2	1.4
	Downlink	859 – 894	57	-2.5	0.7
27	Uplink	807 – 824	65	-1.9	1.6
	Downlink	852 – 869	59	-2.3	1.1
28	Uplink	703 – 748	71	-1.5	1.5
	Downlink	758 – 803	71	-1.5	1.9
29	Downlink	717 – 728	73	-1.4	1.6
30	Uplink	2305 – 2315	74	-1.3	5.7
	Downlink	2350 – 2360	67	-1.7	4.9
32	Downlink	1452 – 1496	39	-4.1	0.4
33		1900-1920	71	-1.5	5.2
34		2010-2025	76	-1.2	5.4
35		1850-1910	71	-1.5	4.9
36		1930-1990	73	-1.4	4.9
37		1910-1930	72	-1.4	5.2
38		2570 – 2620	57	-2.5	3
39		1880 – 1920	71	-1.5	5
40		2300 – 2400	65	-1.9	4.9
41		2496 – 2690	56	-2.5	3.1
42		3400 – 3600	56	-2.6	7.1

Electrical - General

Impedance	50Ω
Polarization	Linear
Radiation Pattern	Omni
Input Power	10 W

Mechanical

Casing	UV Resistant PC/ABS
Flammability Rating	UL-94
Connector	SMA Male Hinged 90°

Environmental

Temperature Range	-40°C to 85°C
Humidity	Non-condensing 65°C 95% RH

LTE BANDS			
Band Number	LTE / LTE-Advanced / WCDMA / HSPA / HSPA+ / TD-SCDMA		
	Uplink	Downlink	Covered
1	UL: 1920 to 1980	DL: 2110 to 2170	✓
2	UL: 1850 to 1910	DL: 1930 to 1990	✓
3	UL: 1710 to 1785	DL: 1805 to 1880	✓
4	UL: 1710 to 1755	DL: 2110 to 2155	✓
5	UL: 824 to 849	DL: 869 to 894	✓
6	UL: 875 to 885	DL: 830 to 840	✓
7	UL: 2500 to 2570	DL: 2620 to 2690	✓
8	UL: 880 to 915	DL: 925 to 960	✓
9	UL: 1749.9 to 1784.9	DL: 1844.9 to 1879.9	✓
10	UL: 1710 to 1770	DL: 2110 to 2170	✓
11	UL: 1427.9 to 1447.9	DL: 1475.9 to 1495.9	✗
12	UL: 699 to 716	DL: 729 to 746	✓
13	UL: 777 to 787	DL: 746 to 756	✓
14	UL: 788 to 798	DL: 758 to 768	✓
17	UL: 704 to 716	DL: 734 to 746 (LTE only)	✓
18	UL: 815 to 830	DL: 860 to 875 (LTE only)	✓
19	UL: 830 to 845	DL: 875 to 890	✓
20	UL: 832 to 862	DL: 791 to 821	✓
21	UL: 1447.9 to 1462.9	DL: 1495.9 to 1510.9	✓
22	UL: 3410 to 3490	DL: 3510 to 3590	✓
23	UL: 2000 to 2020	DL: 2180 to 2200 (LTE only)	✓
24	UL: 1625.5 to 1660.5	DL: 1525 to 1559 (LTE only)	✓
25	UL: 1850 to 1915	DL: 1930 to 1995	✓
26	UL: 814 to 849	DL: 859 to 894	✓
27	UL: 807 to 824	DL: 852 to 869 (LTE only)	✓
28	UL: 703 to 748	DL: 758 to 803 (LTE only)	✓
29	UL: -	DL: 717 to 728 (LTE only)	✓
30	UL: 2305 to 2315	DL: 2350 to 2360 (LTE only)	✓
31	UL: 452.5 to 457.5	DL: 462.5 to 467.5 (LTE only)	✗
32	UL: -	DL: 1452 - 1496	✓
33		1900 to 1920	✓
34		2010 to 2025	✓
35		1850 to 1910	✓
36		1930 to 1990	✓
37		1910 to 1930	✓
38		2570 to 2620	✓
39		1880 to 1920	✓
40		2300 to 2400	✓
41		2496 to 2690	✓
42		3400 to 3600	✓
43		3600 to 3800	✗

*Covered bands represent an efficiency greater than 20% in free space

3. Antenna Characteristics

3.1 Test Setup

Straight Antenna in Free Space

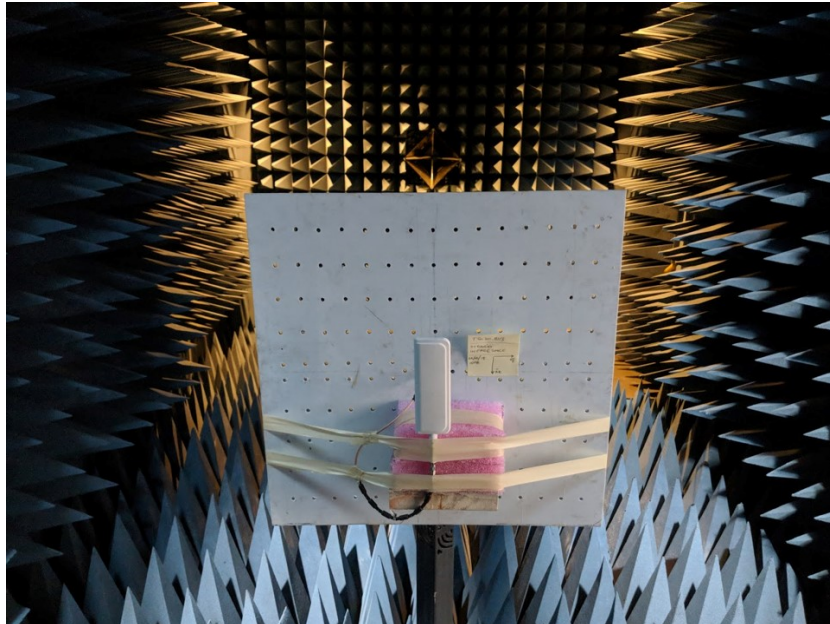

Bent Antenna in Free Space

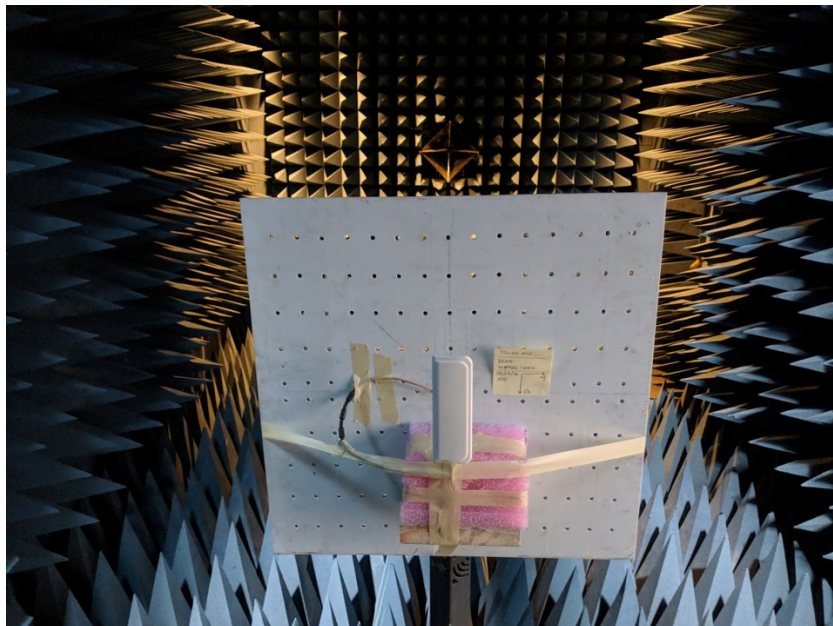

Straight Antenna on Ground Plane Edge

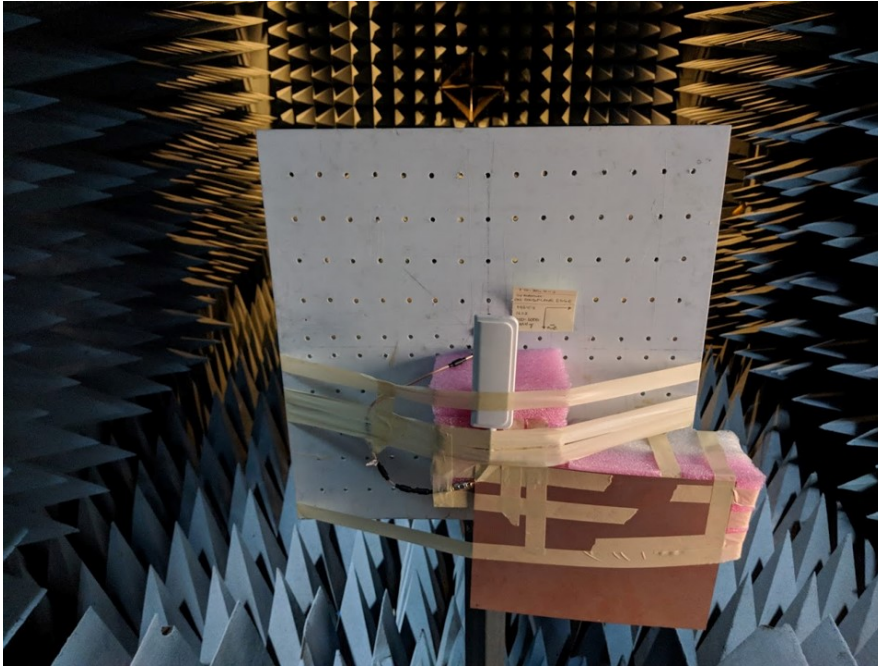

Straight Antenna on Ground Plane Edge

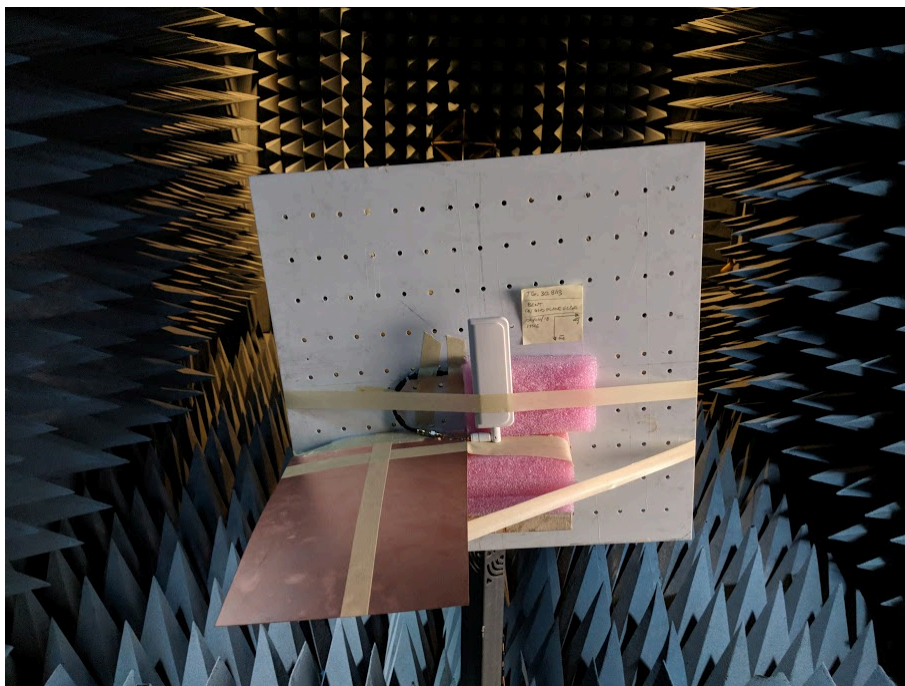

3.2 Return Loss

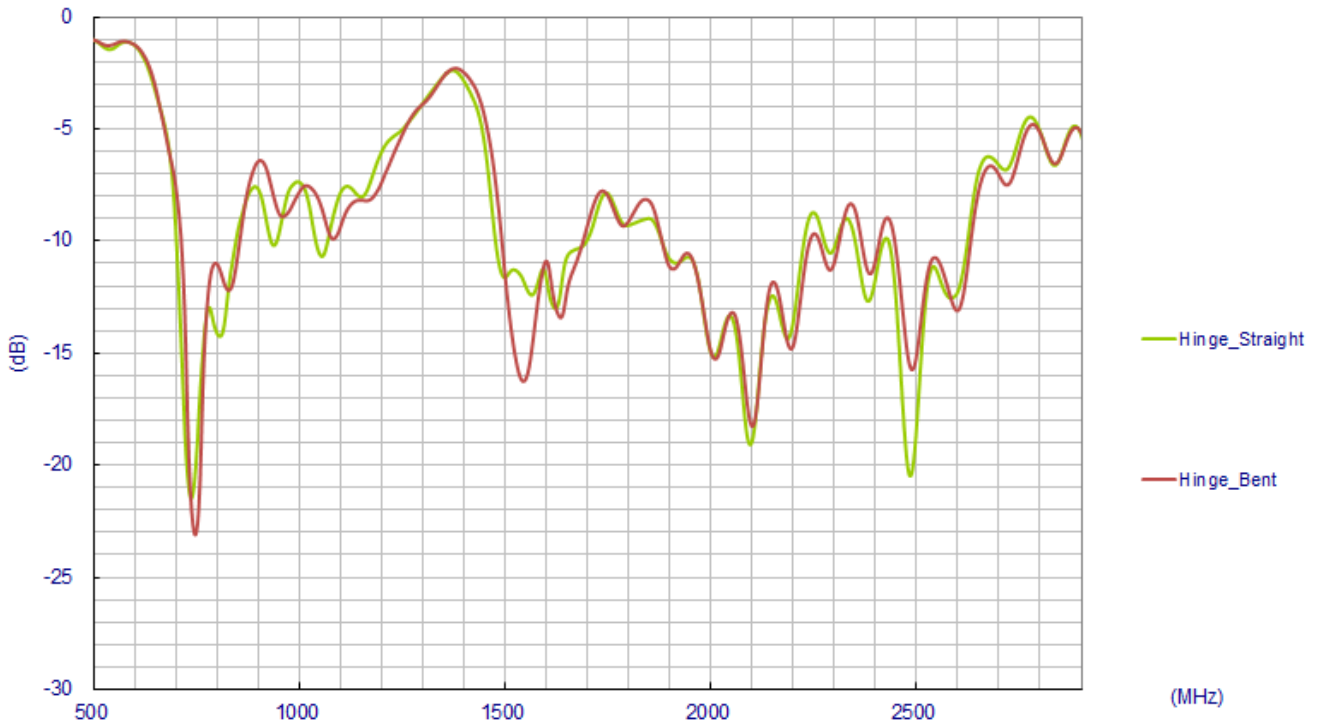

3.3 Peak Gain

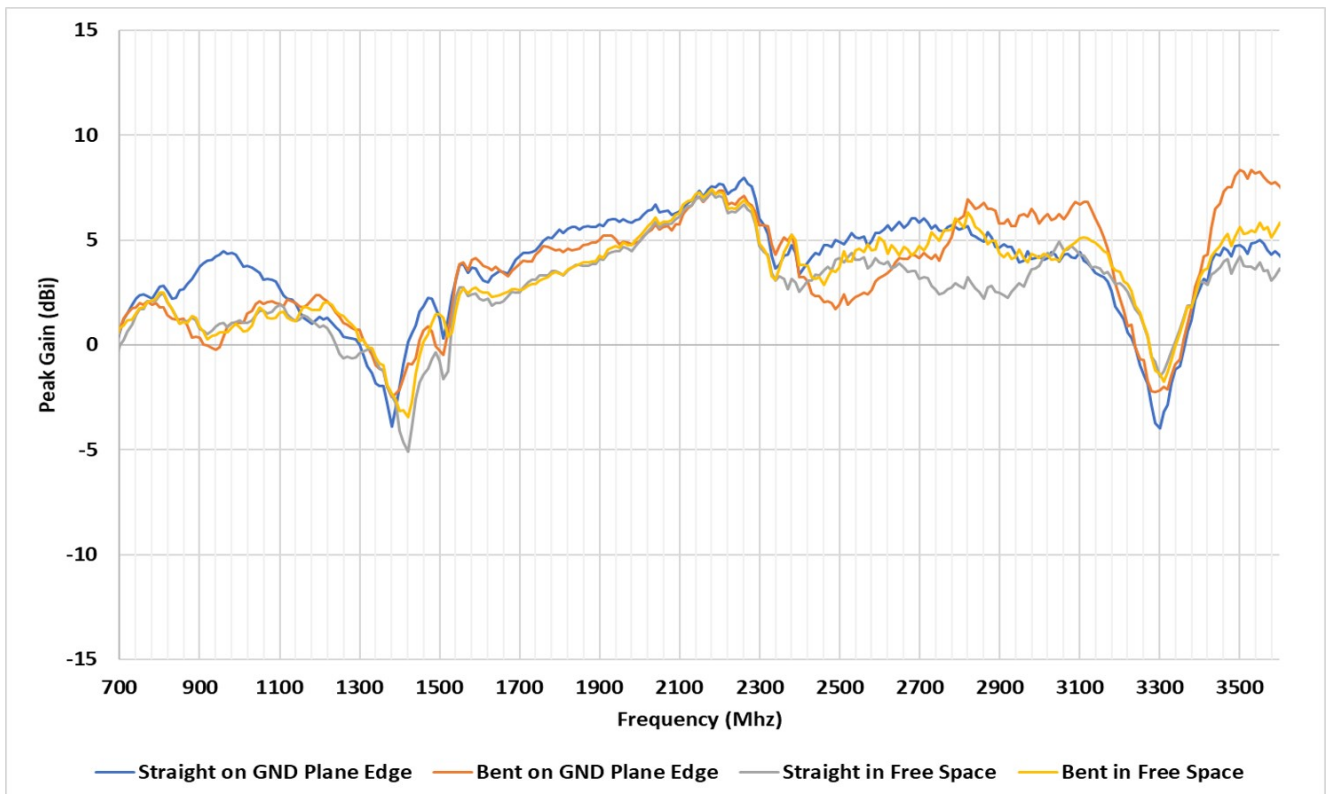

3.4 Average Gain

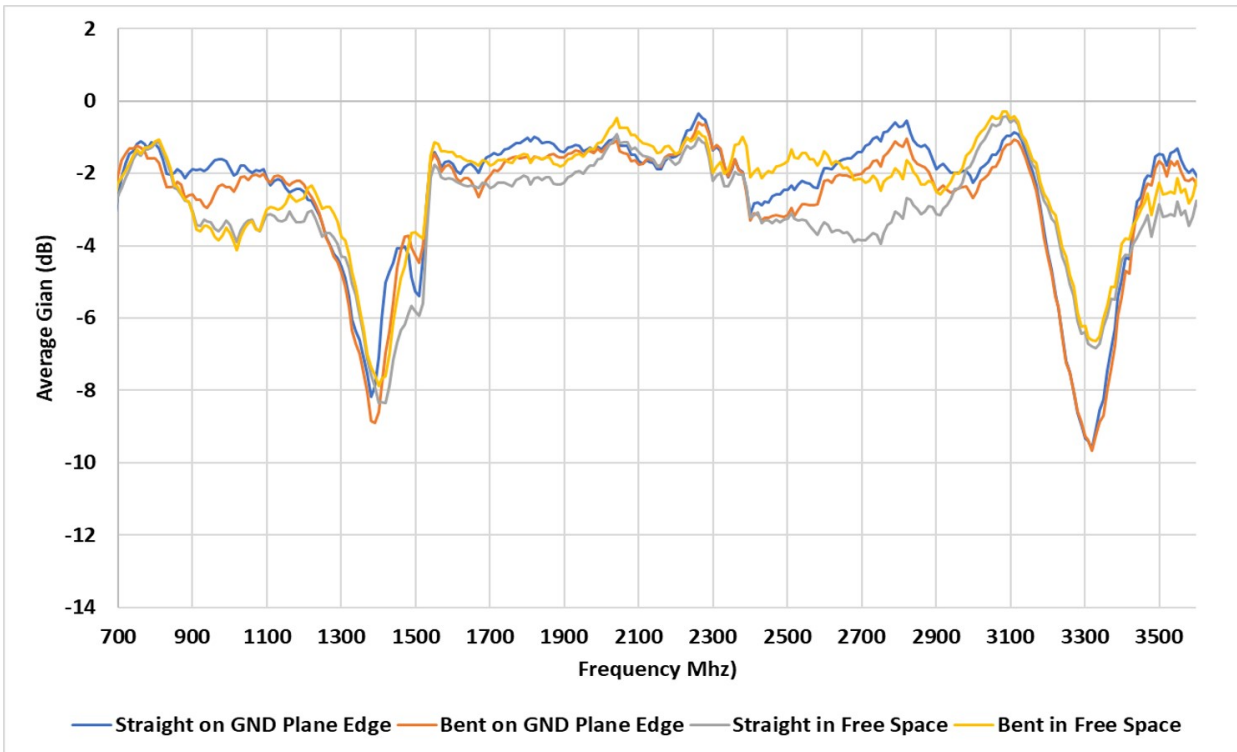

3.5 Efficiency

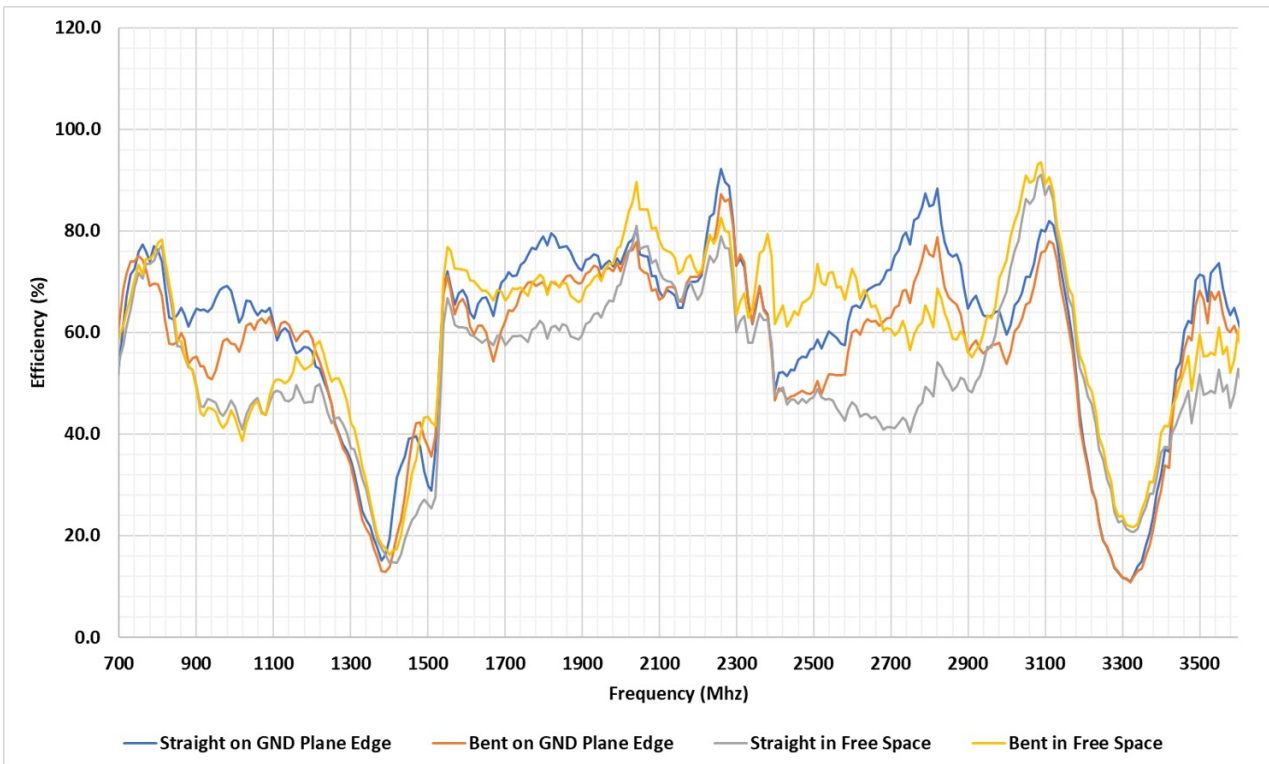

4. Antenna Radiation Patterns

4.1 Antenna setup (Free Space Straight)

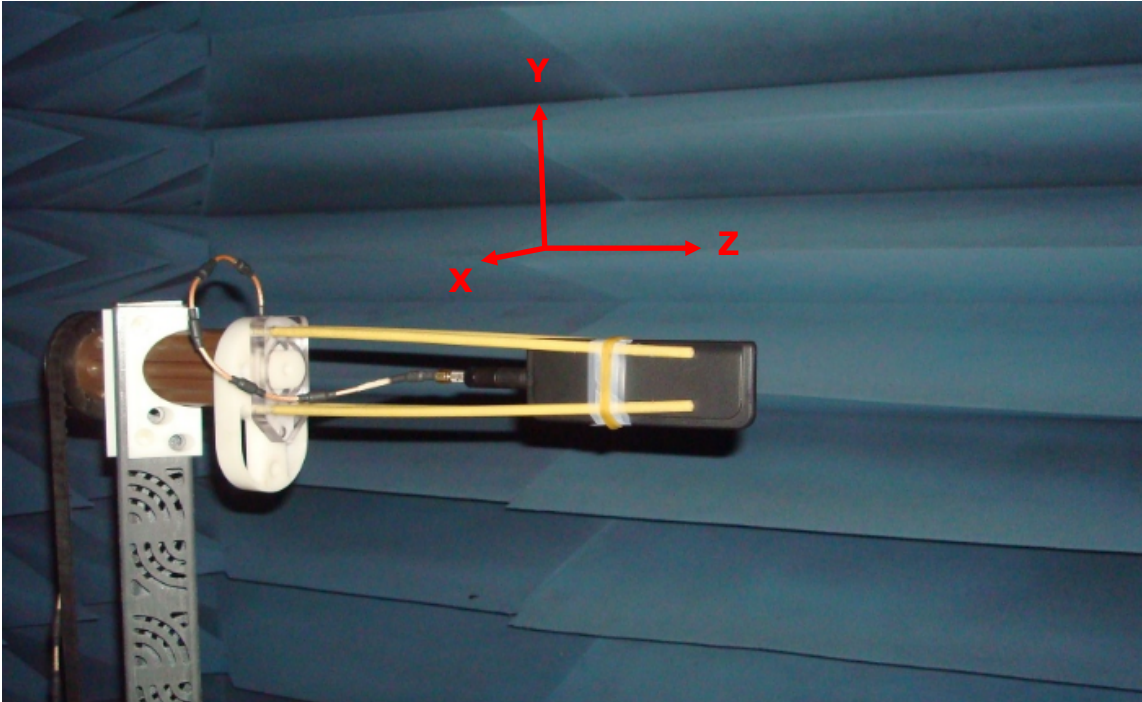

5. Radiation Patterns

XY Plane

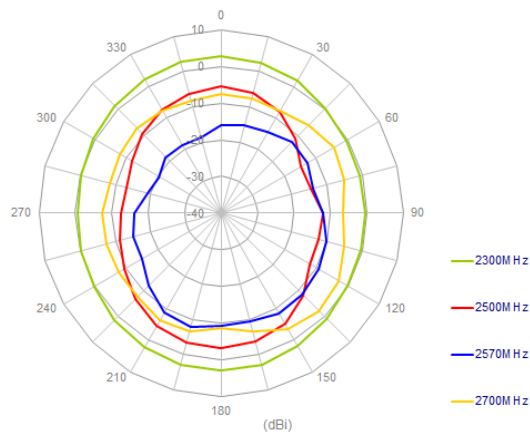
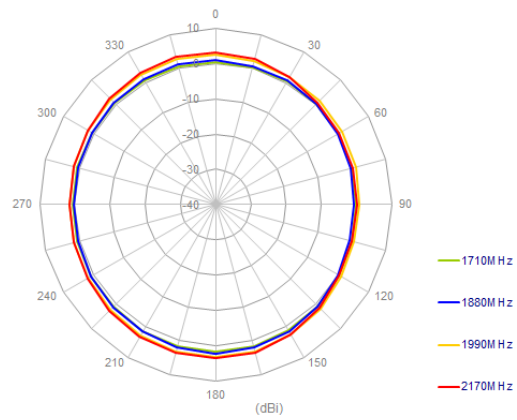
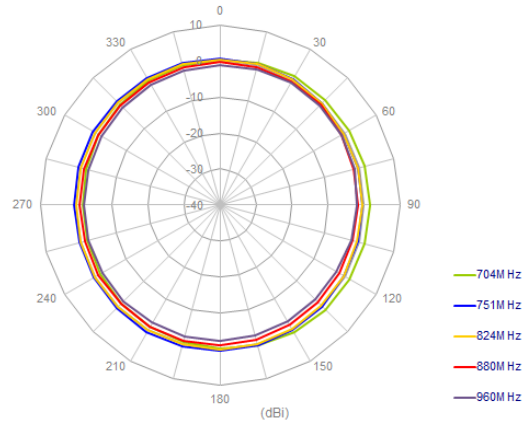

XZ Plane

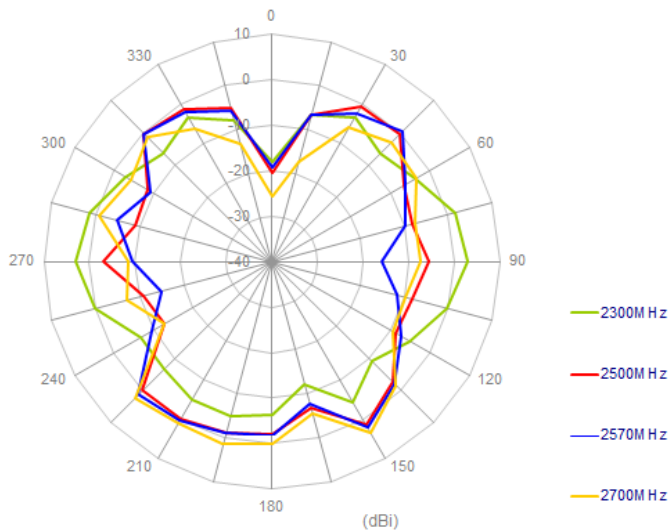
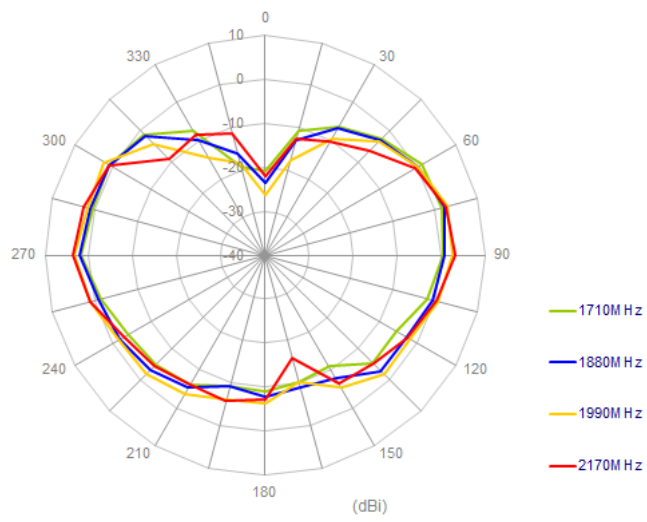
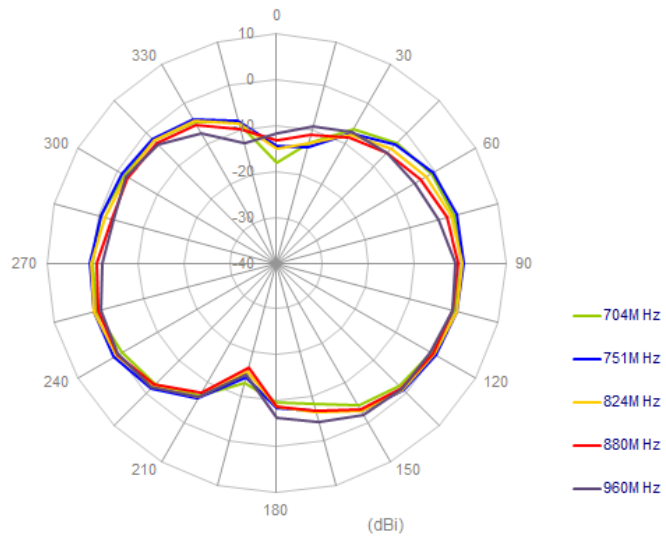

5.1 Antenna setup (Free Space Bent)

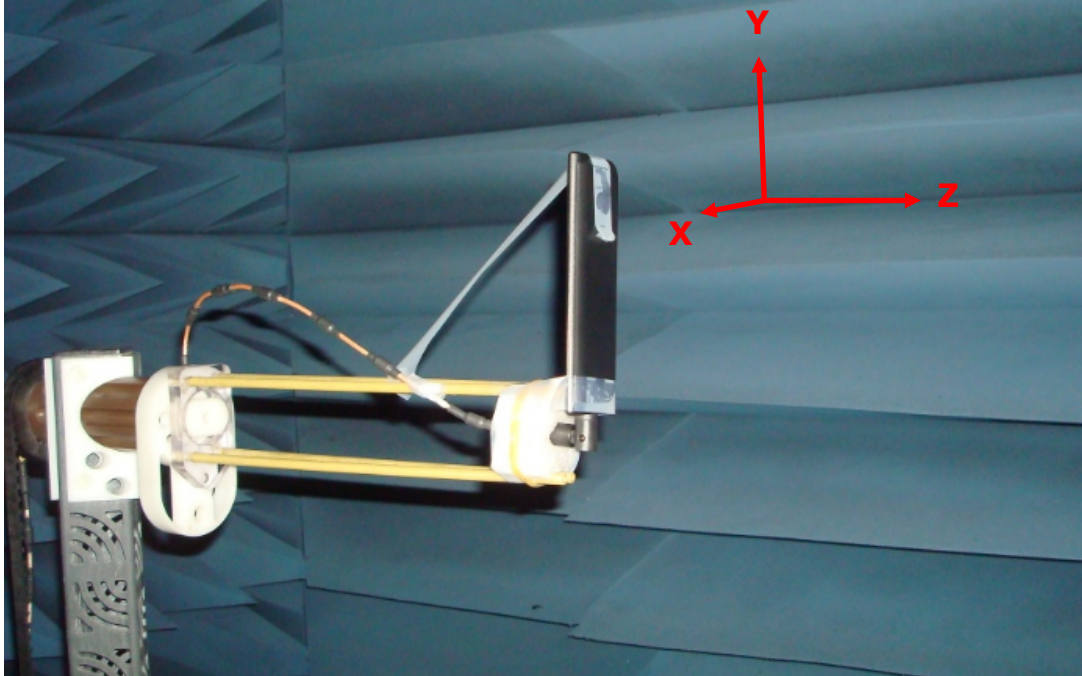

5.2 Radiation Patterns

XY Plane

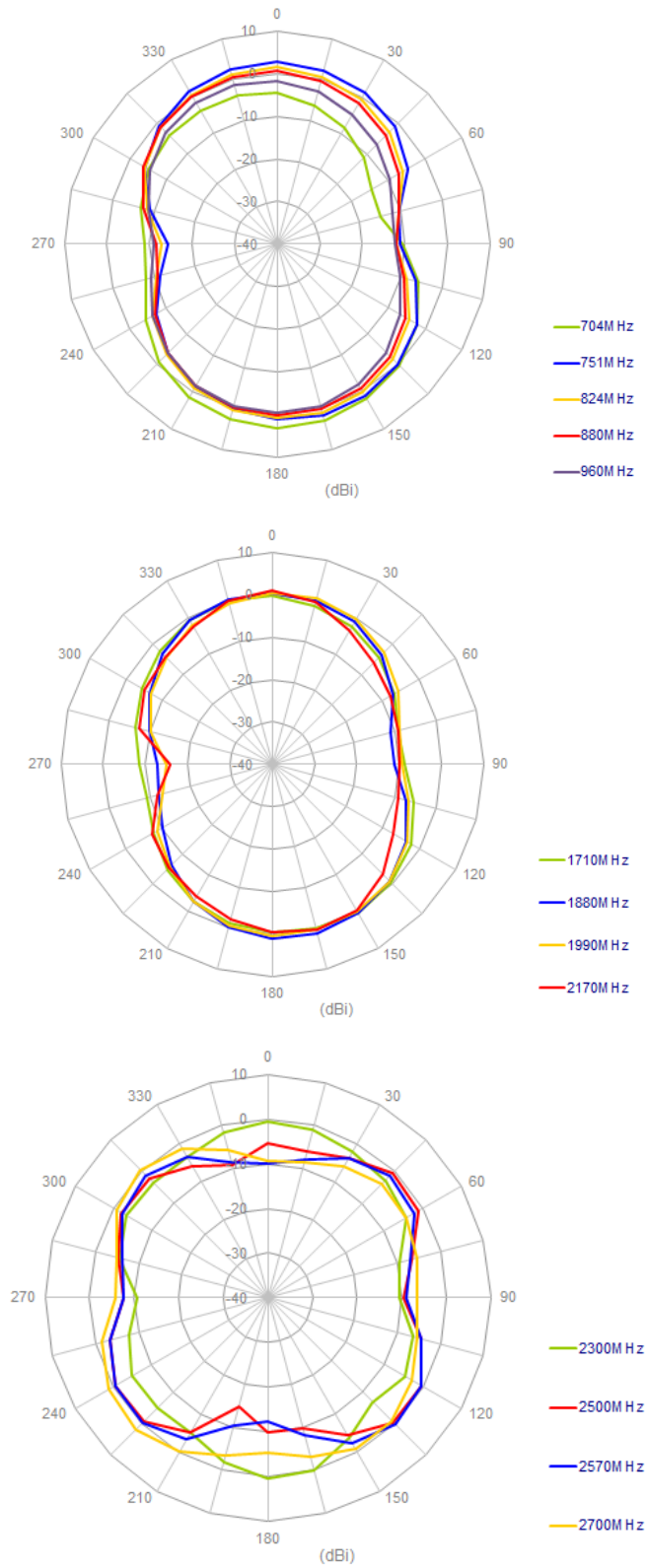

XZ Plane

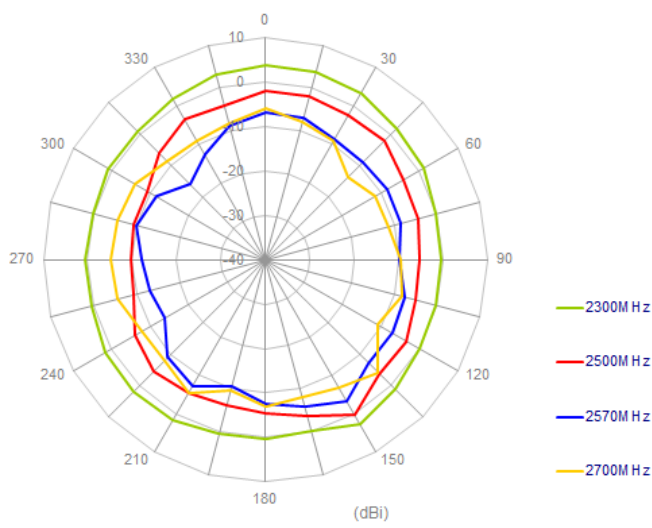
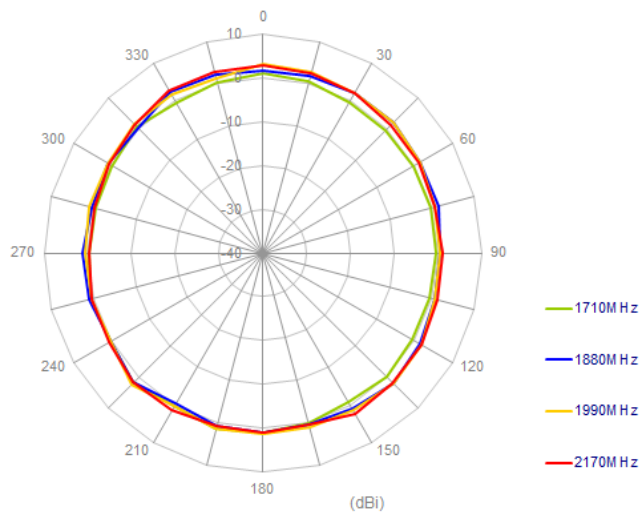
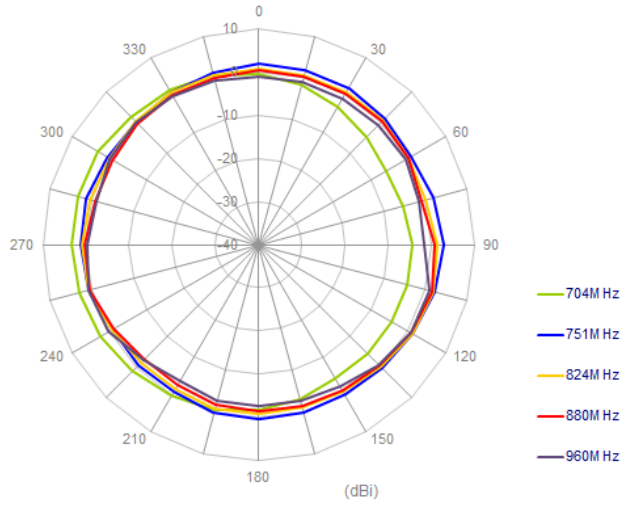

5.3 Antenna setup (On 300x300mm ground center straight)

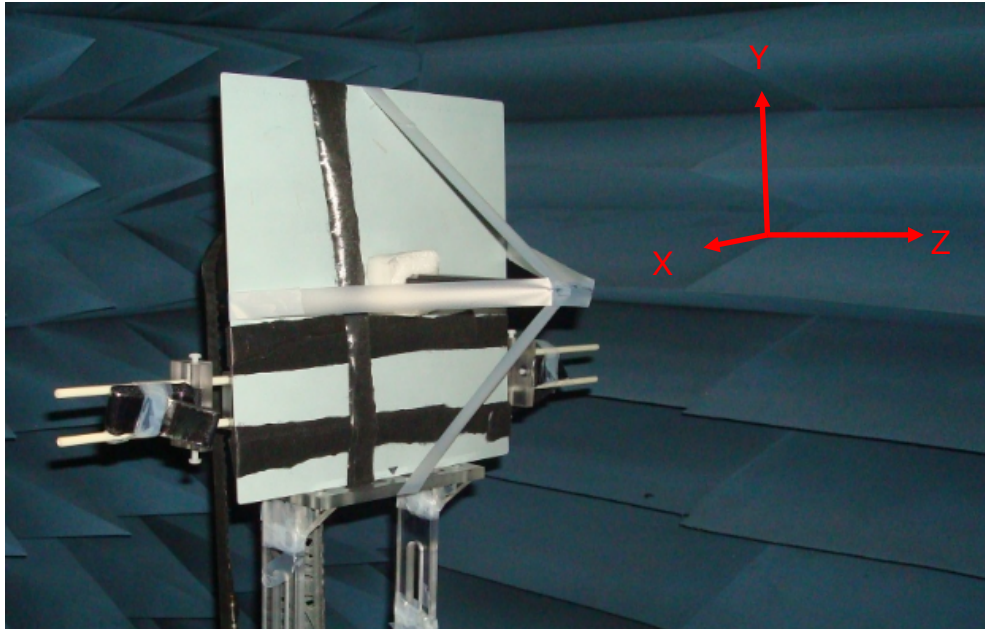

5.4 Radiation Patterns

XY Plane

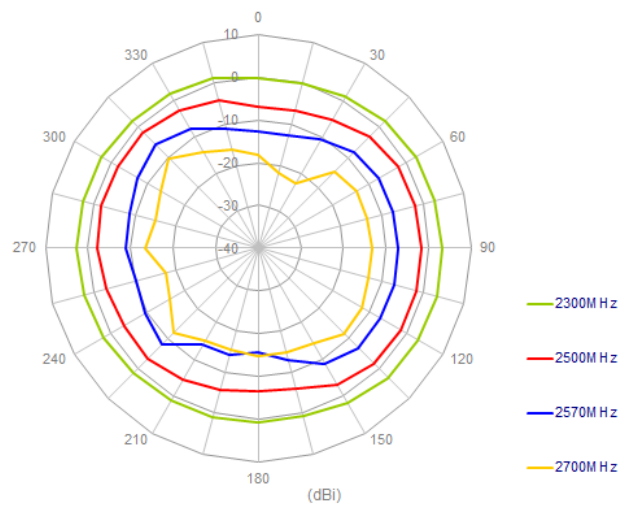
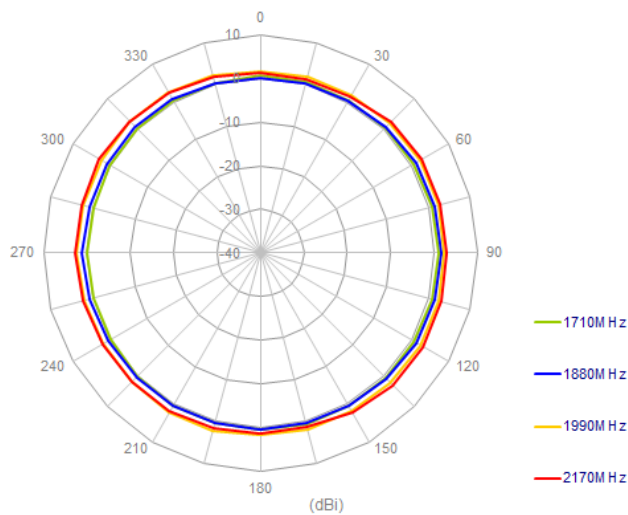
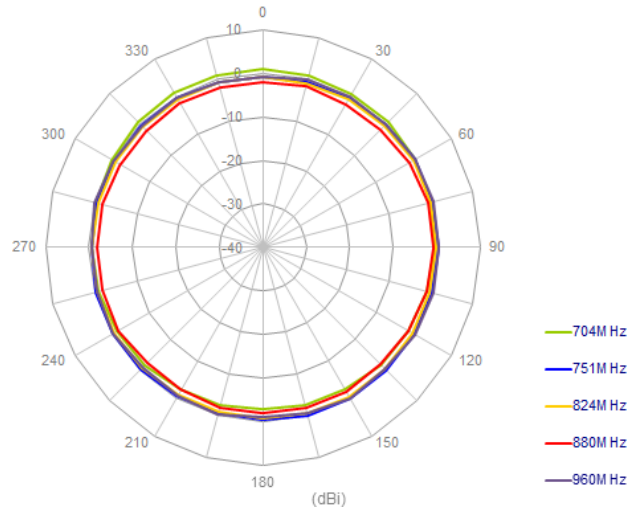

XZ Plane

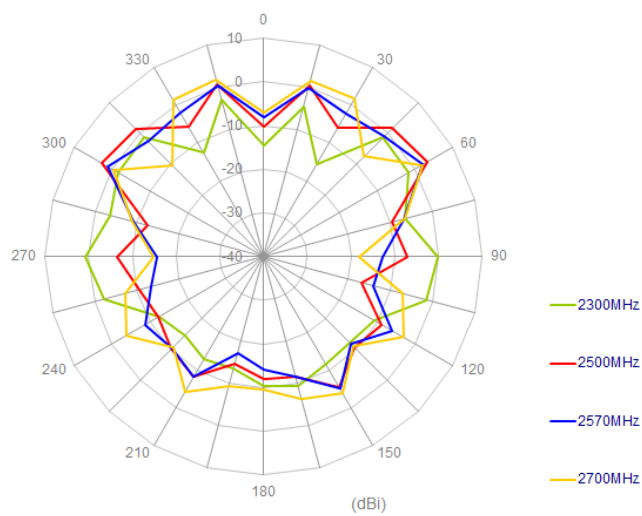
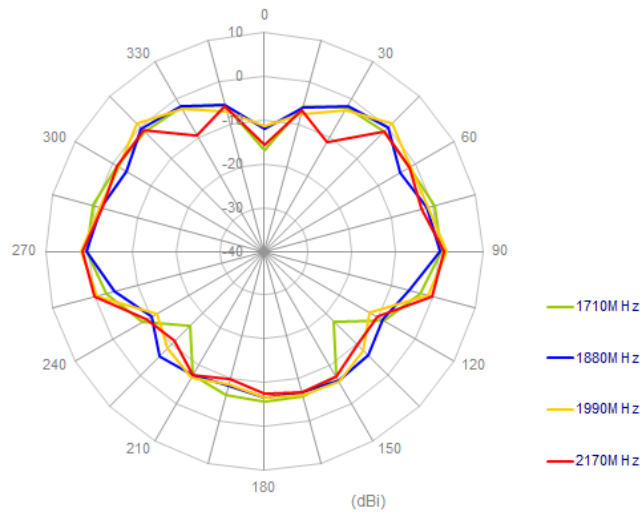
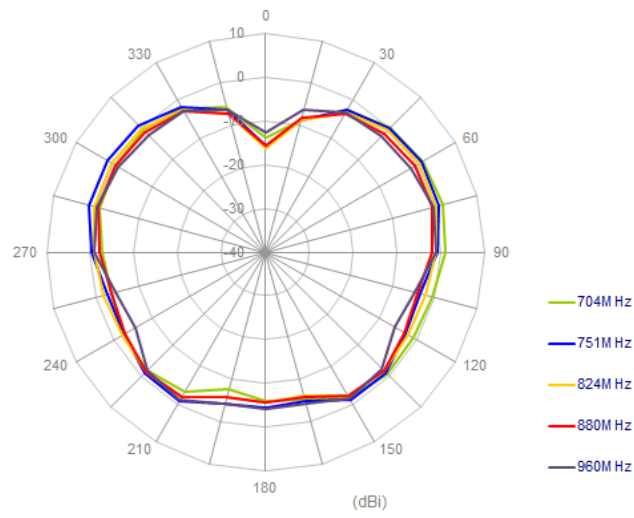

5.5 Antenna setup (On 300x300mm ground center bent)

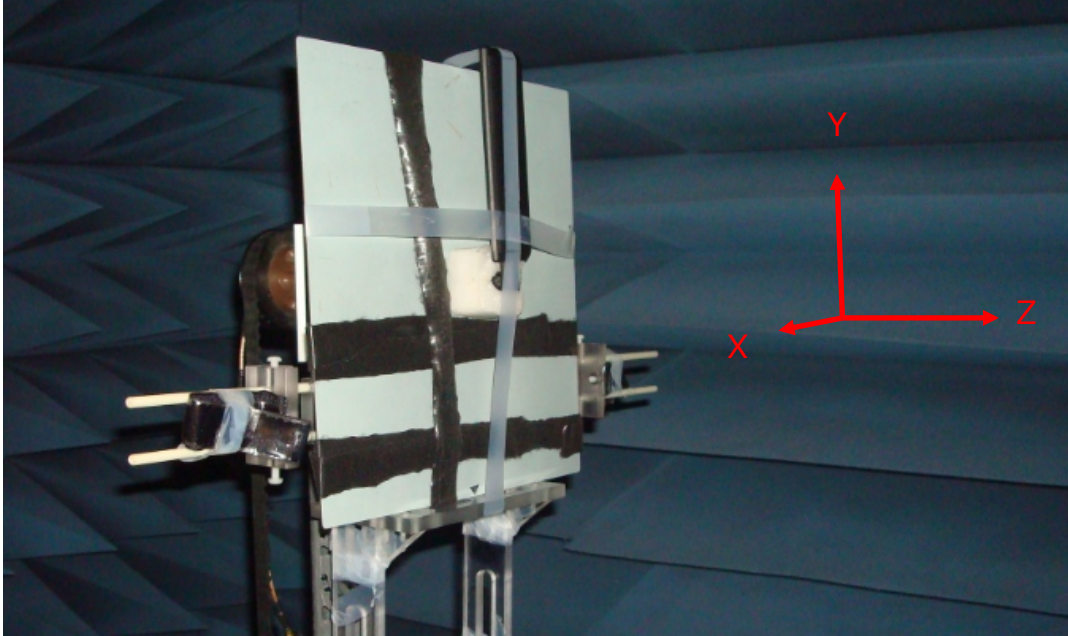

6. Radiation Patterns

XY Plane

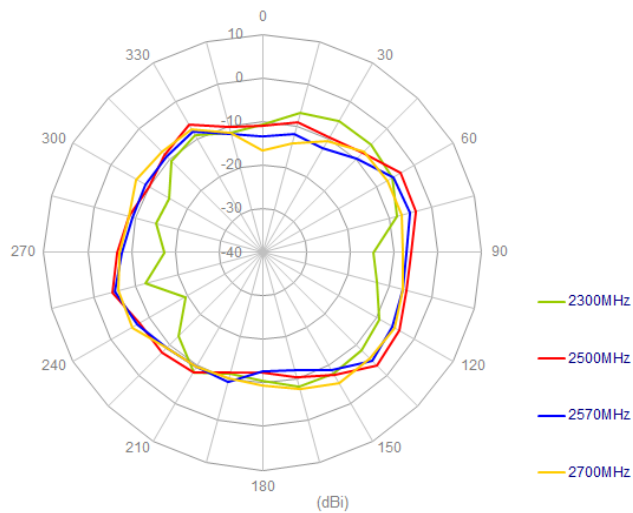
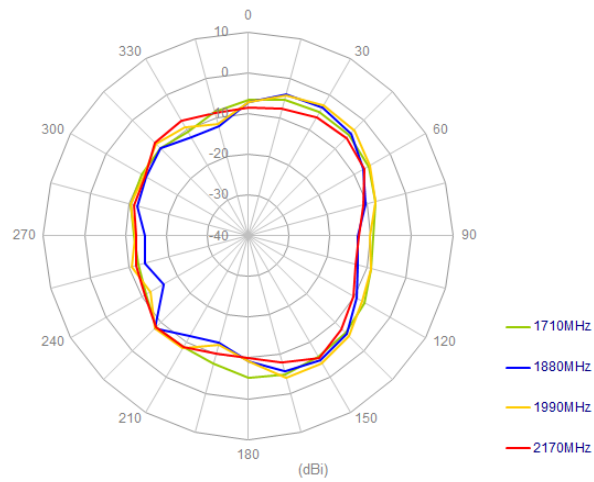
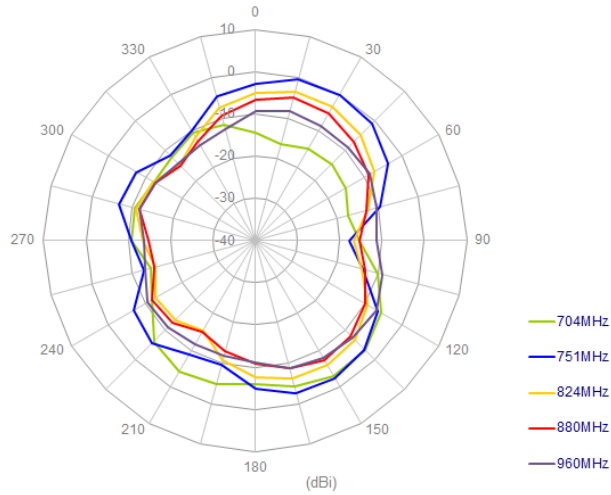

XZ Plane

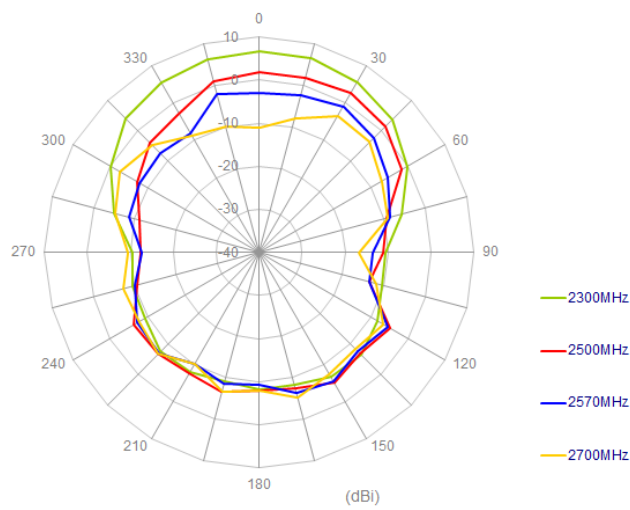
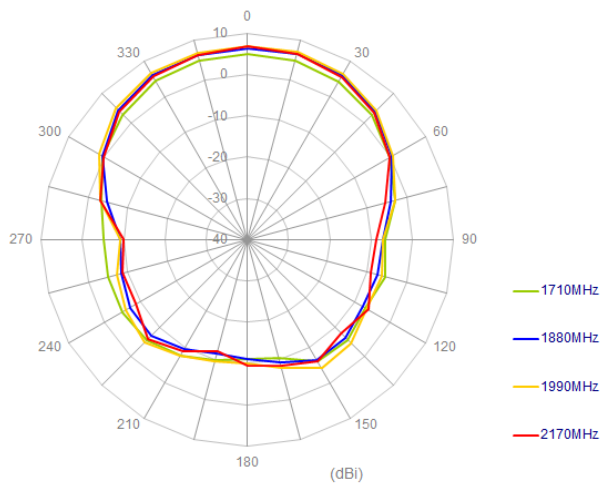
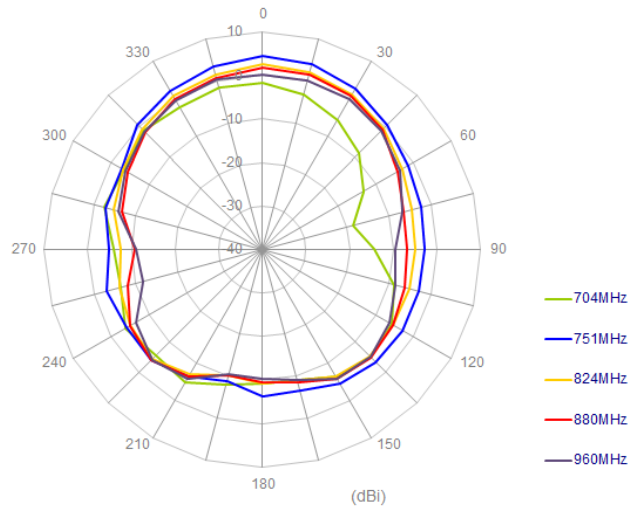

6.1 Antenna setup (On 300x300mm ground edge straight)

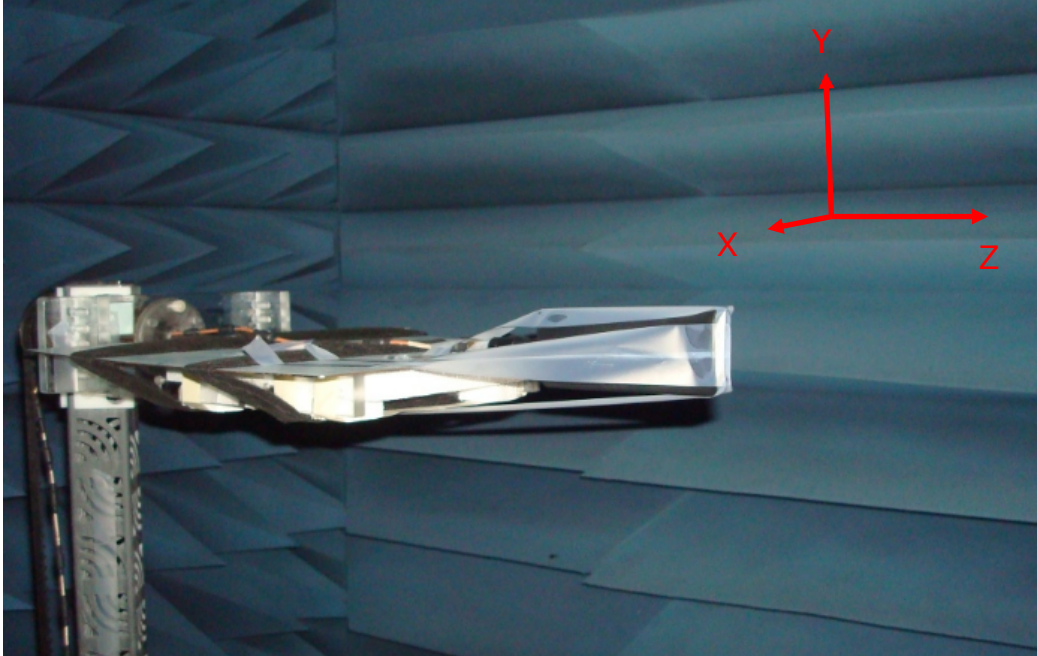

6.2 Radiation Patterns

XY Plane

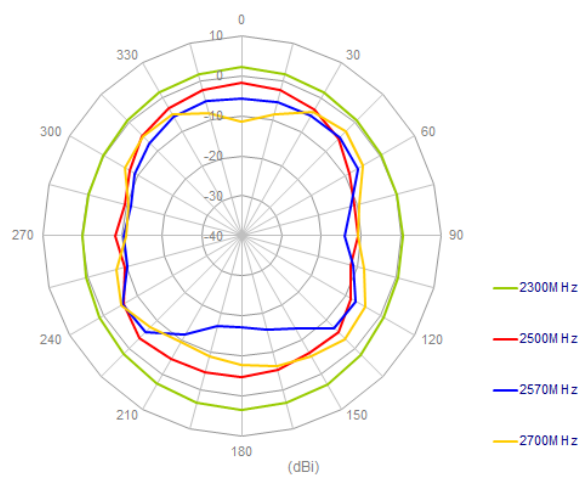
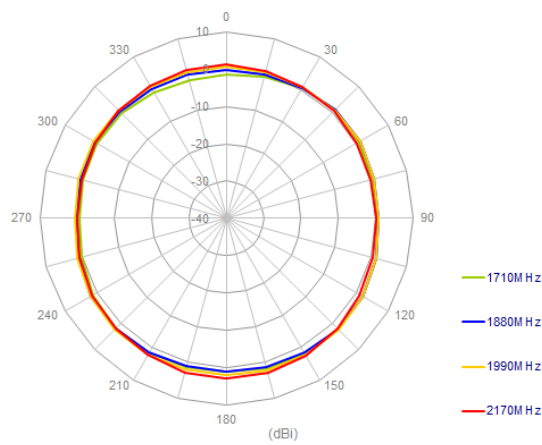
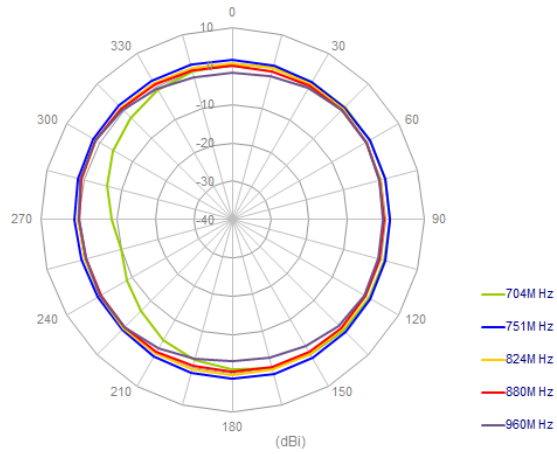

XZ Plane

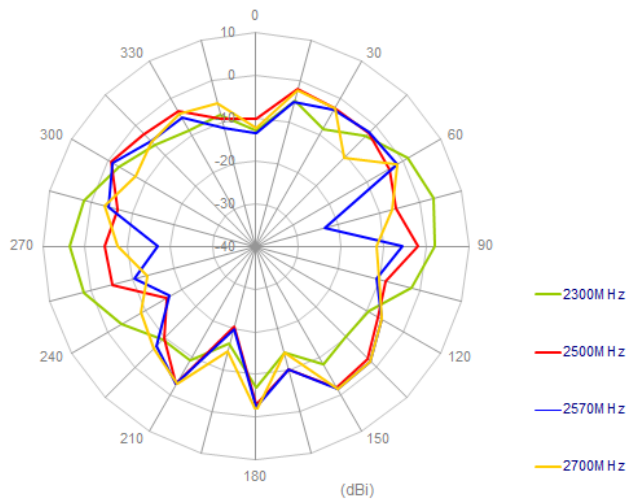
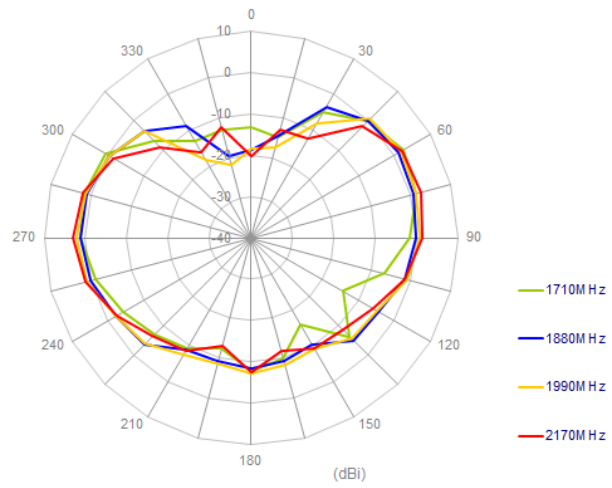
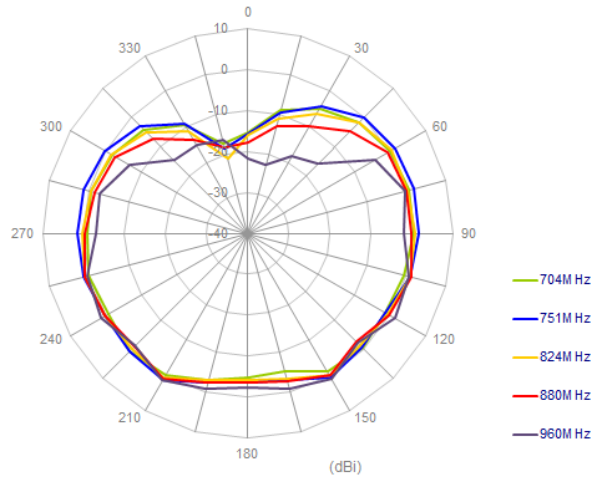

6.3 Antenna setup (On 300x300mm ground edge bent)



6.4 Radiation Patterns

XY Plane

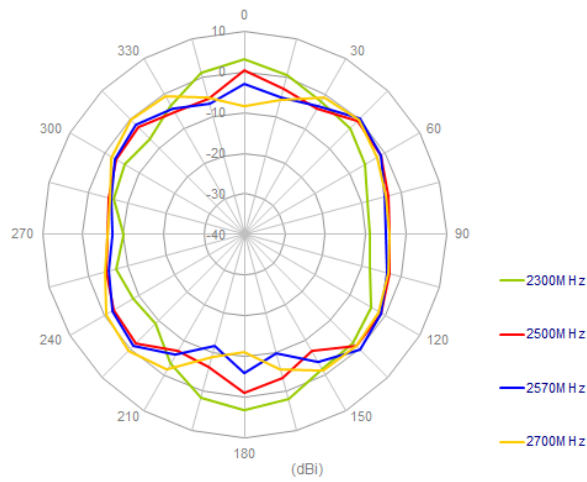
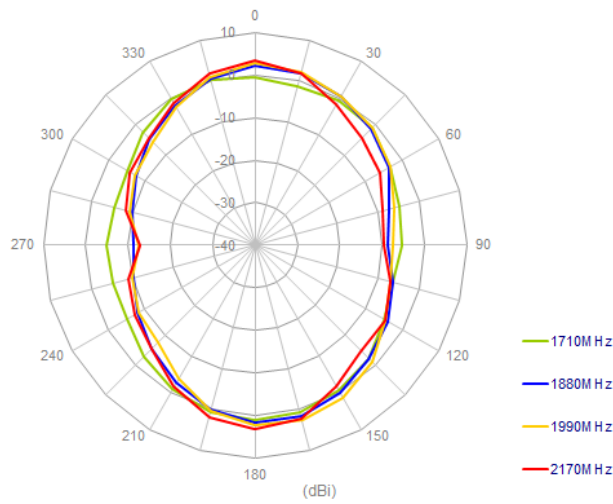
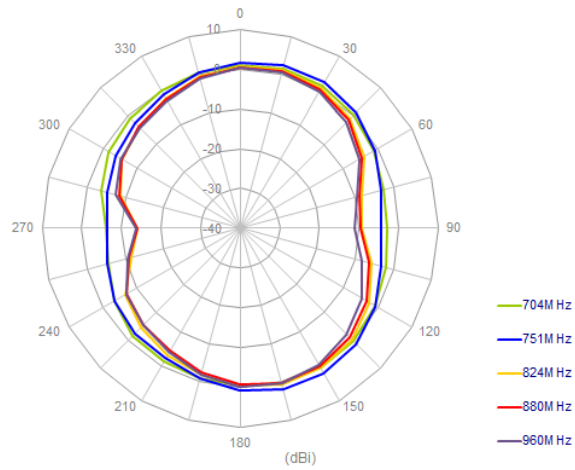

XZ Plane

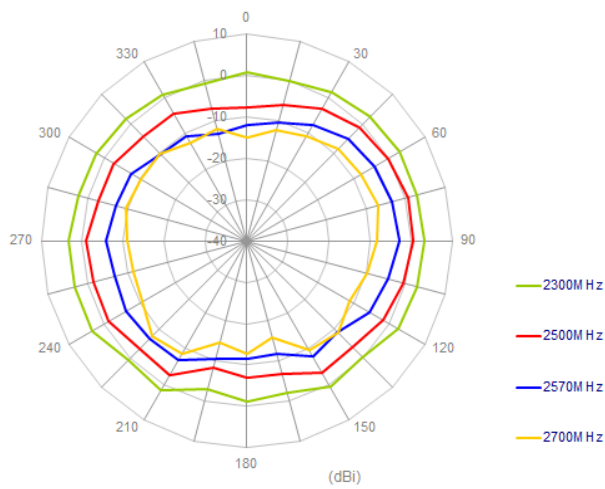
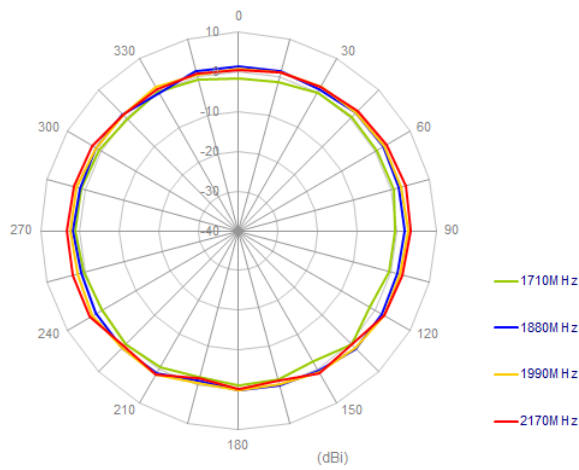
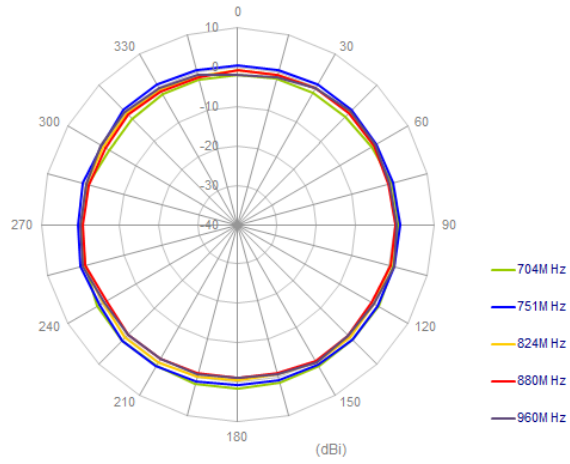

6.4 Antenna setup (On Ground edge straight)

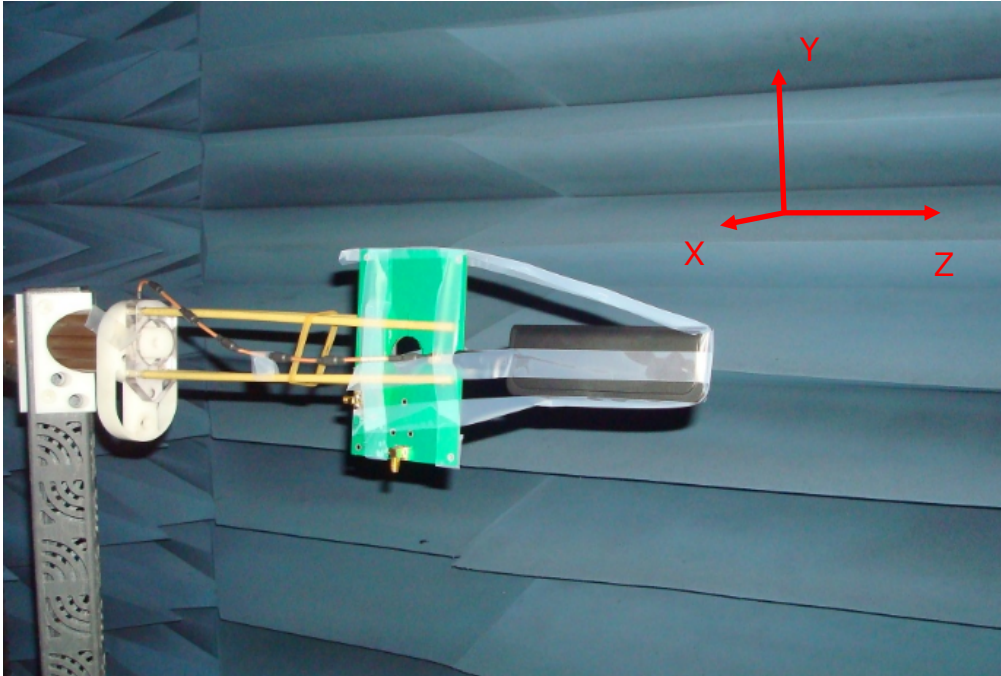

6.6 Radiation Patterns

XY Plane

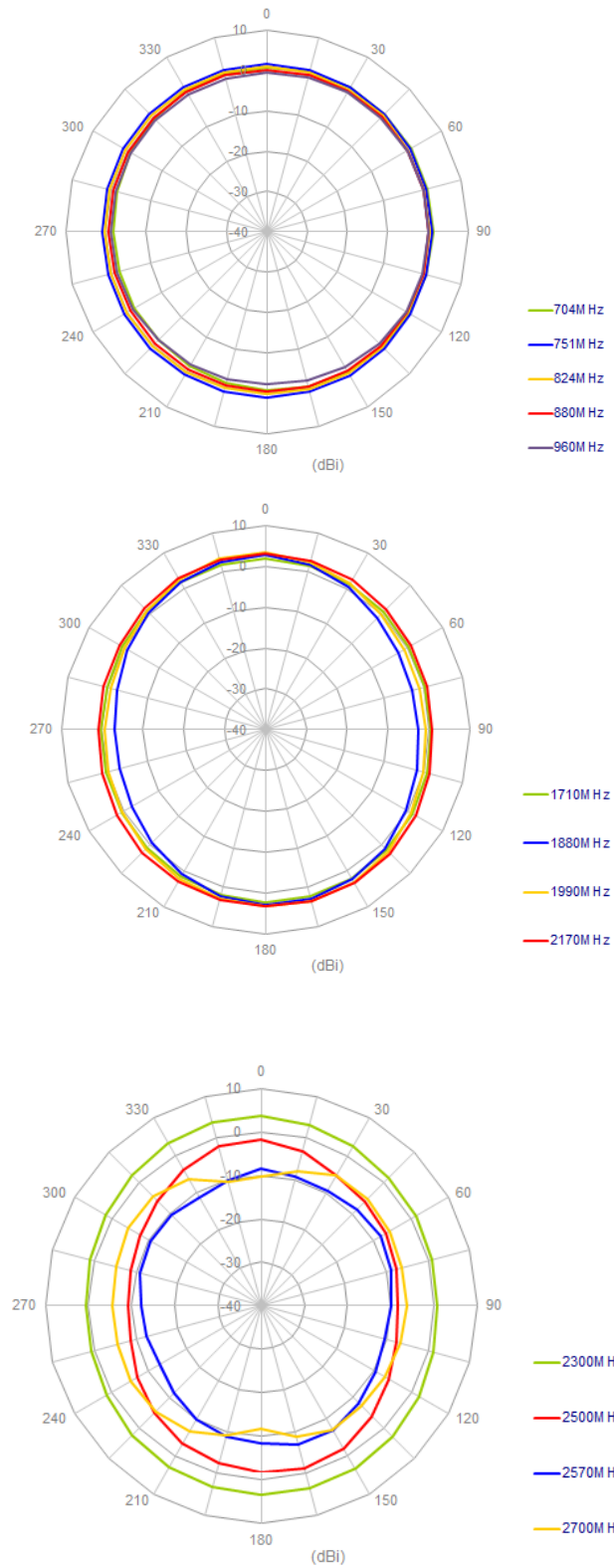

XZ Plane

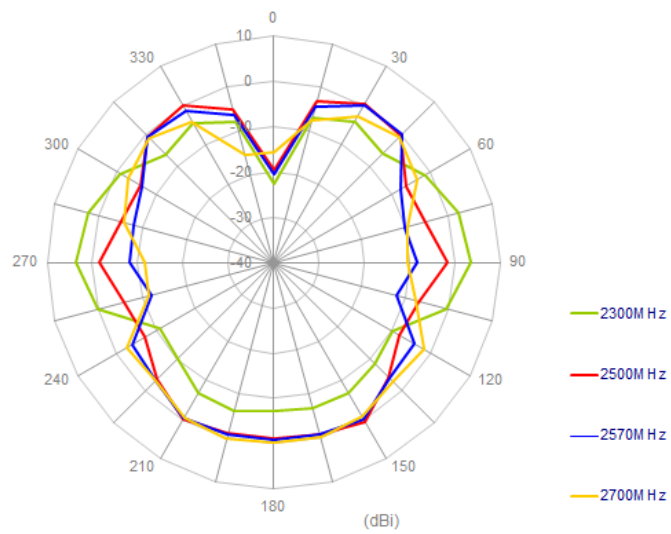
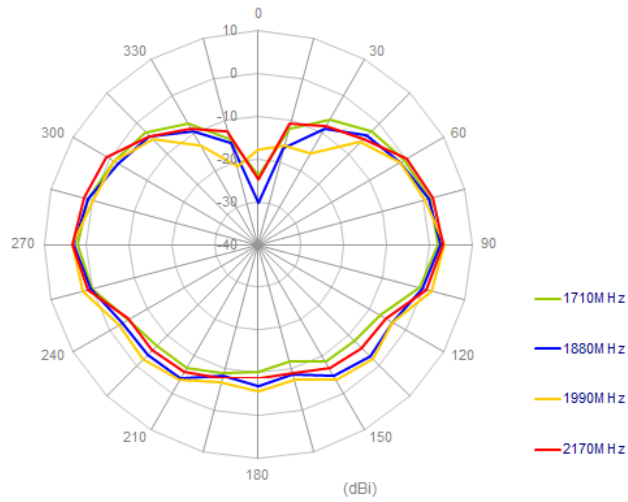
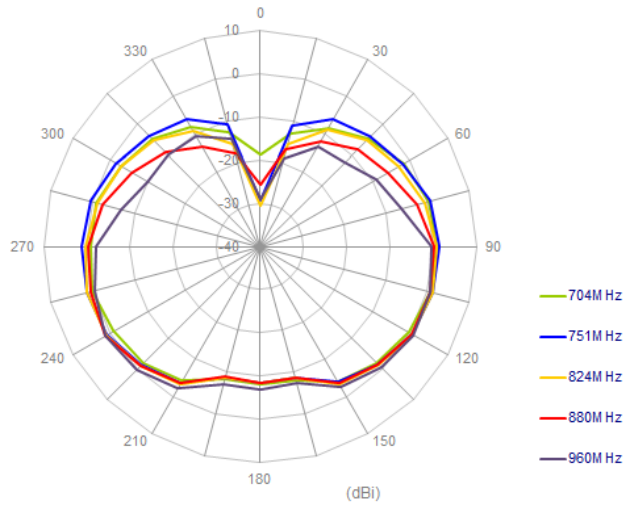

6.7 Antenna setup (On Ground edge bent)

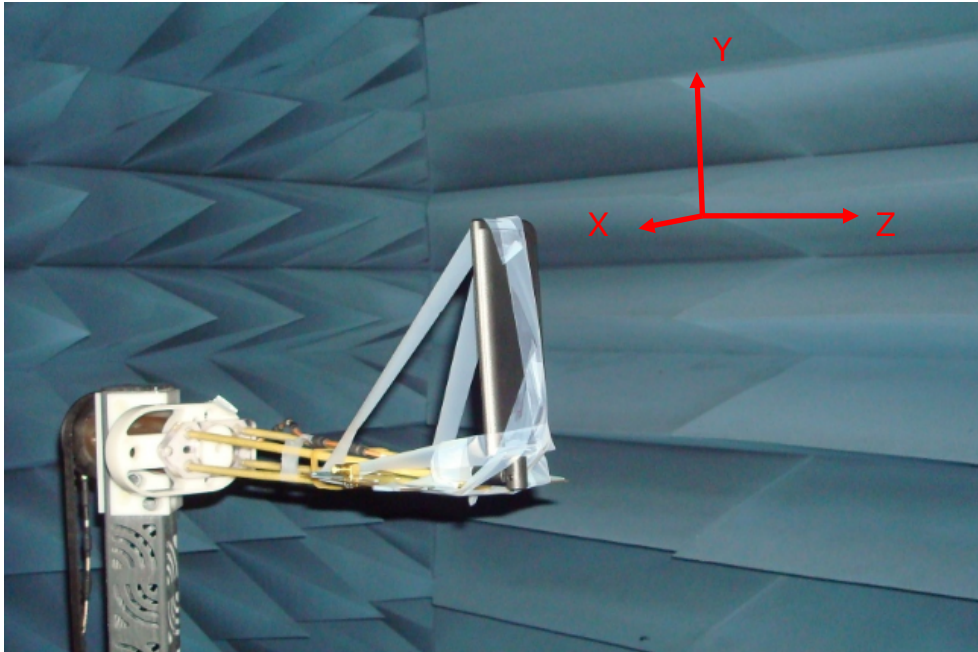

6.8 Radiation Patterns

XY Plane

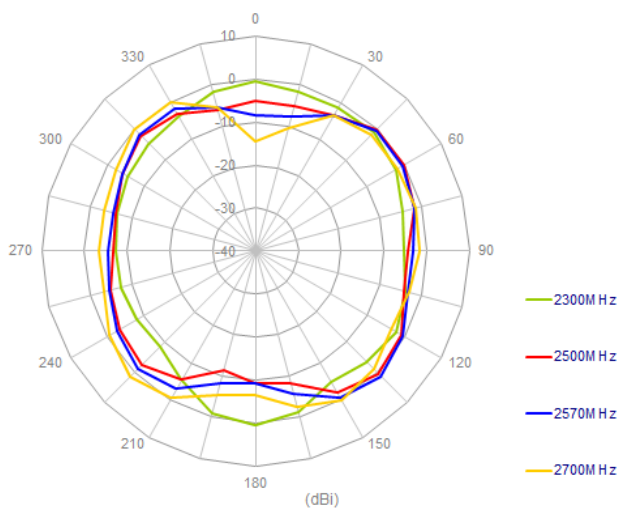
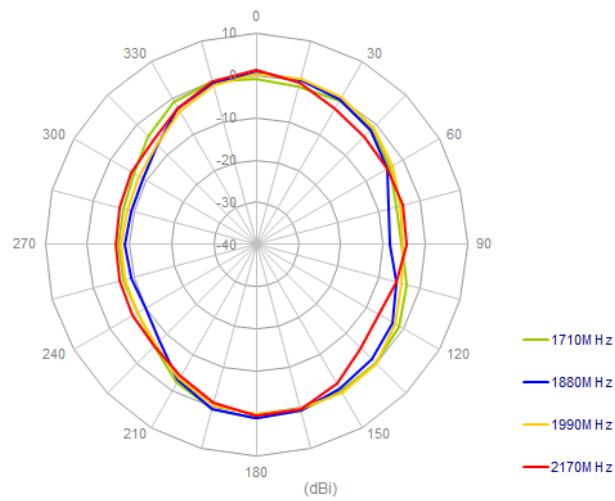
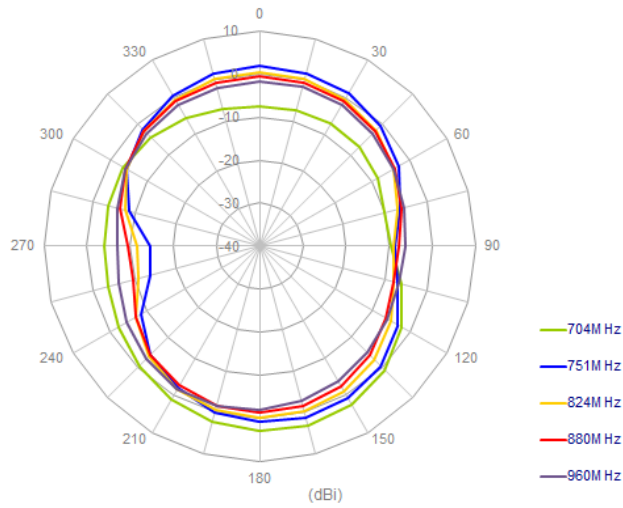

XZ Plane

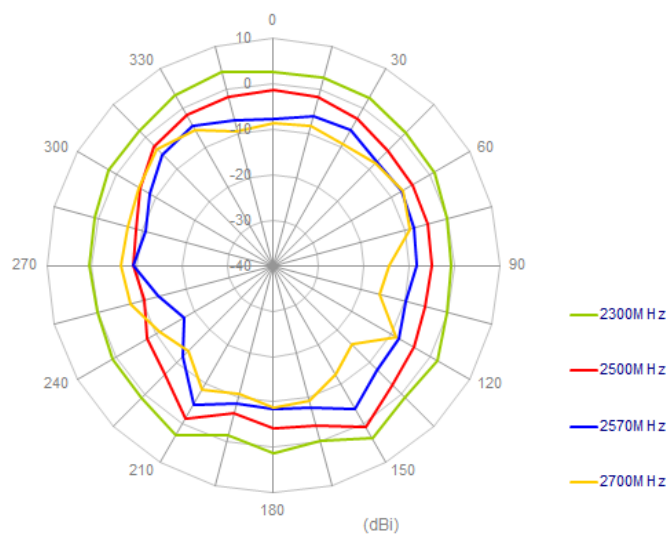
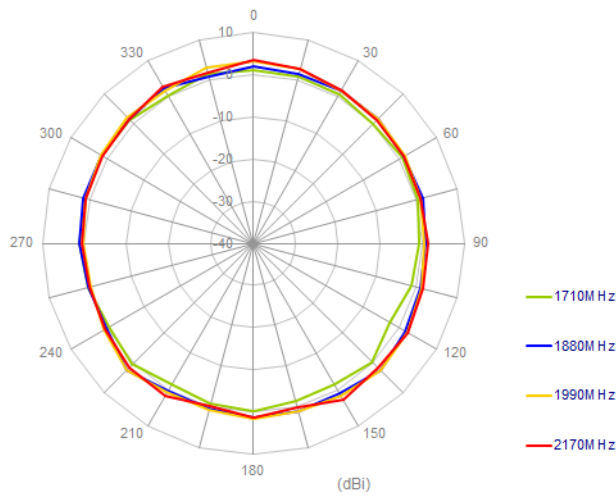
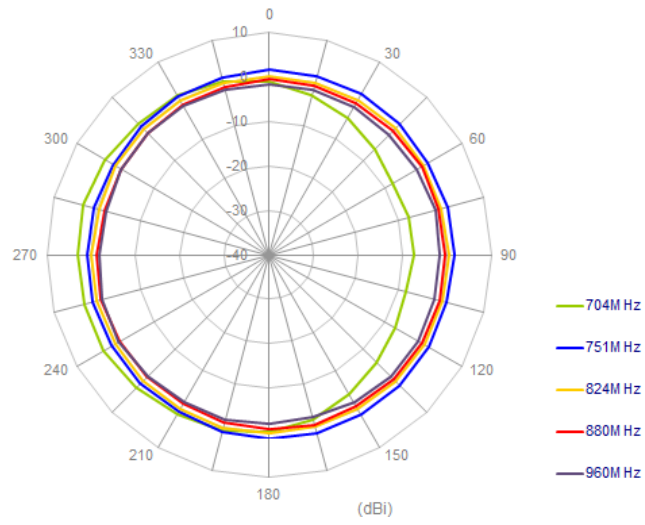

7.Mechanical Drawing

3D View

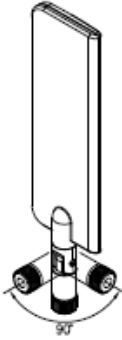

Front View

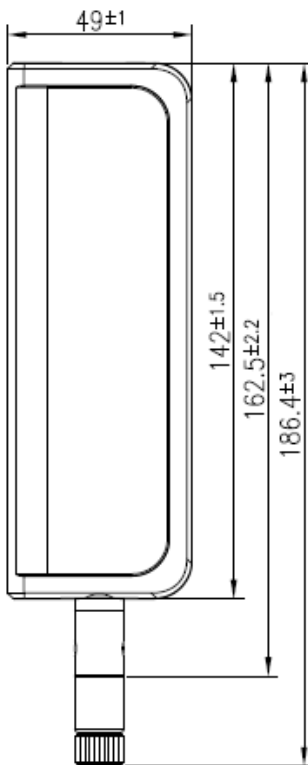

Side View

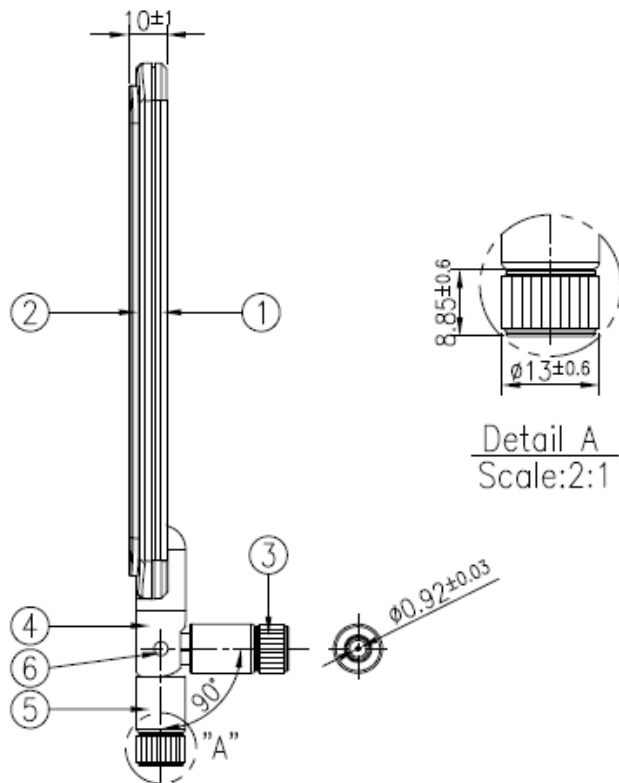

NOTES:

- 1.All material must be RoHS compliant.
- 2.Open/short, insertion loss QC required.
- 3.The connectors have a fixed orientation to each other.

	Name	P/N	Material	Finish	QTY
1	Housing_Bottom_Hinge_W	000112G020020A	ABS	White	1
2	Housing_Top_W	000112G000020A	ABS	White	1
3	SMA(M)ST	210212L020020A	Brass	White	1
4	Hinge_Top_W	000112G040020A	Nylon	White	1
5	Hinge_Bottom_W	000112G030020A	PC+PBT	White	1
6	Rotary Shaft	000612G000002A	Brass	Ni Plated	2

7. Packaging

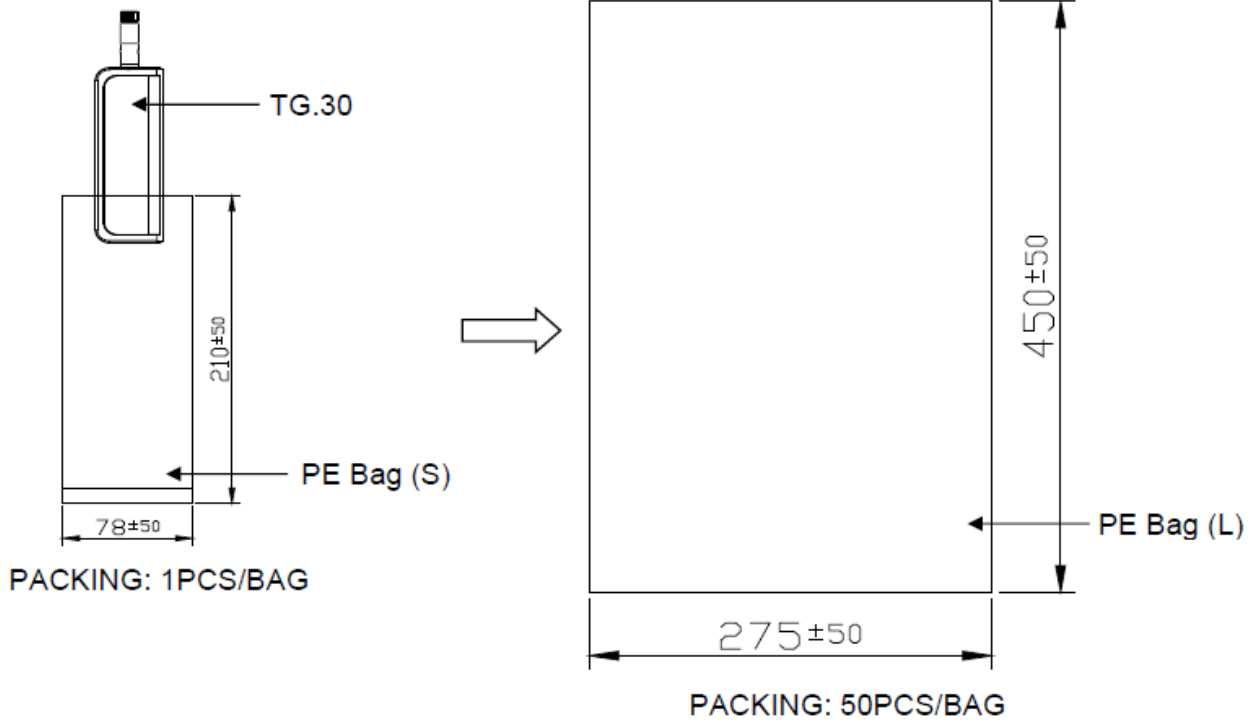

Taoglas makes no warranties based on the accuracy or completeness of the contents of this document and reserves the right to make changes to specifications and product descriptions at any time without notice. Taoglas reserves all rights to this document and the information contained herein.

Reproduction, use or disclosure to third parties without express permission is strictly prohibited.

Copyright © Taoglas Ltd.