

MUR120-MUR190

Super Fast Rectifiers

VOLTAGE RANGE: 200 --- 900 V

CURRENT: 1.0 A



DO - 41

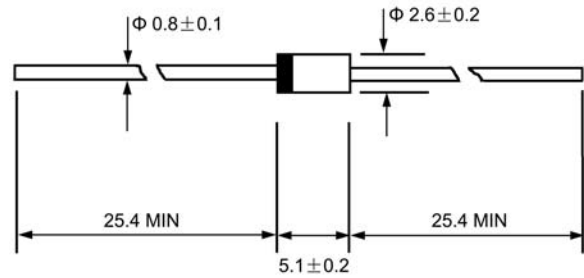

Dimensions in millimeters

Features

- ◇ Low cost
- ◇ Low leakage
- ◇ Low forward voltage drop
- ◇ High current capability
- ◇ Easily cleaned with alcohol, Isopropanol and similar solvents
- ◇ The plastic material carries U/L recognition 94V-0

Mechanical Data

- ◇ Case: JEDEC DO--41, molded plastic
- ◇ Polarity: Color band denotes cathode
- ◇ Weight: 0.012 ounces, 0.34 grams
- ◇ Mounting position: Any

MAXIMUM RATINGS AND ELECTRICAL CHARACTERISTICS

Ratings at 25°C ambient temperature unless otherwise specified.

Single phase, half wave, 60 Hz, resistive or inductive load. For capacitive load, derate by 20%.

		MUR 120	MUR 130	MUR 140	MUR 150	MUR 160	MUR 170	MUR 180	MUR 190	UNITS
Maximum recurrent peak reverse voltage	V_{RRM}	200	300	400	500	600	700	800	900	V
Maximum RMS voltage	V_{RMS}	140	210	280	350	420	490	560	630	V
Maximum DC blocking voltage	V_{DC}	200	300	400	500	600	700	800	900	V
Maximum average forward rectified current 9.5mm lead length, @ $T_A=75^\circ C$	$I_{F(AV)}$	1.0								A
Peak forward surge current 8.3ms single half-sine-wave superimposed on rated load @ $T_J=125^\circ C$	I_{FSM}	35.0								A
Maximum instantaneous forward voltage @ 1.0A	V_F	0.875	1.25				1.7			V
Maximum reverse current @ $T_A=25^\circ C$ at rated DC blocking voltage @ $T_A=100^\circ C$	I_R	2.0 50	5.0 150				10.0 100			μA
Maximum reverse recovery time (Note1)	t_{rr}	25	50				75			ns
Typical junction capacitance (Note2)	C_J	22				15				pF
Typical thermal resistance (Note3)	$R_{\theta JA}$	50				60				$^\circ C/W$
Operating junction temperature range	T_J	- 55 ----- + 150								$^\circ C$
Storage temperature range	T_{STG}	- 55 ----- + 150								$^\circ C$

NOTE: 1. Measured with $I_F=0.5A$, $I_R=1A$, $I_{rr}=0.25A$.

2. Measured at 1.0MHz and applied reverse voltage of 4.0V DC.

3. Thermal resistance from junction to ambient.

Ratings AND Characteristic Curves

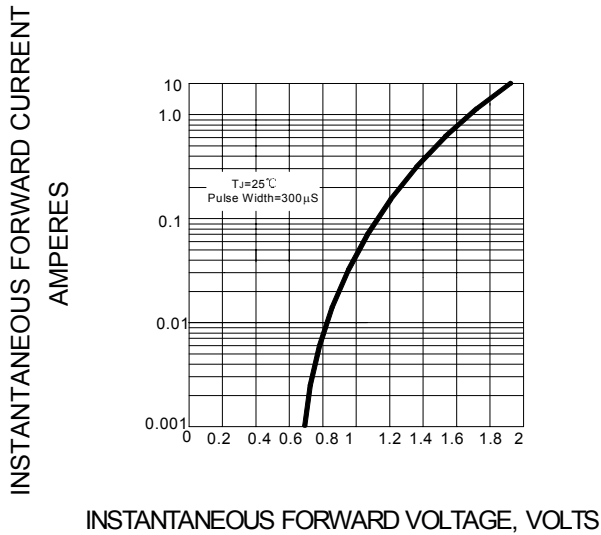
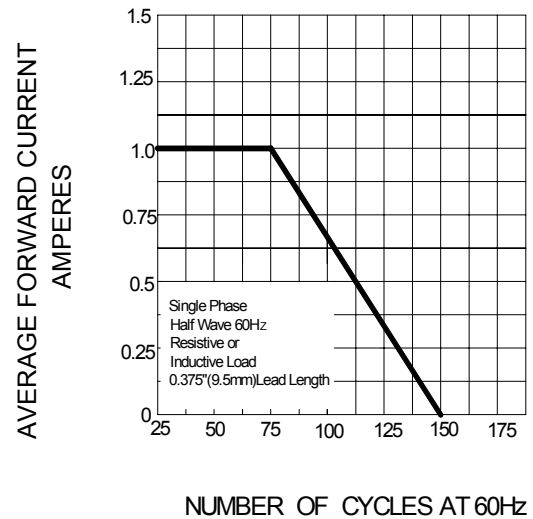
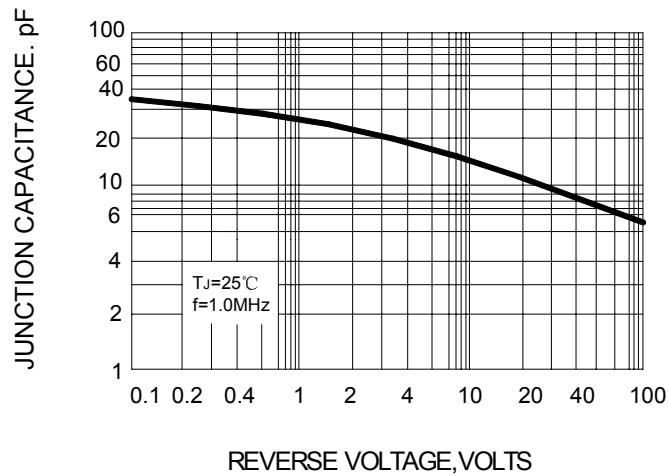
FIG.1 – TYPICAL FORWARD CHARACTERISTICS

FIG.2 – FORWARD DRATING CURVE

FIG.3 – TYPICAL JUNCTION CAPACITANCE

Ratings AND Characteristic Curves

FIG.4 – TYPICAL REVERSE CHARACTERISTICS

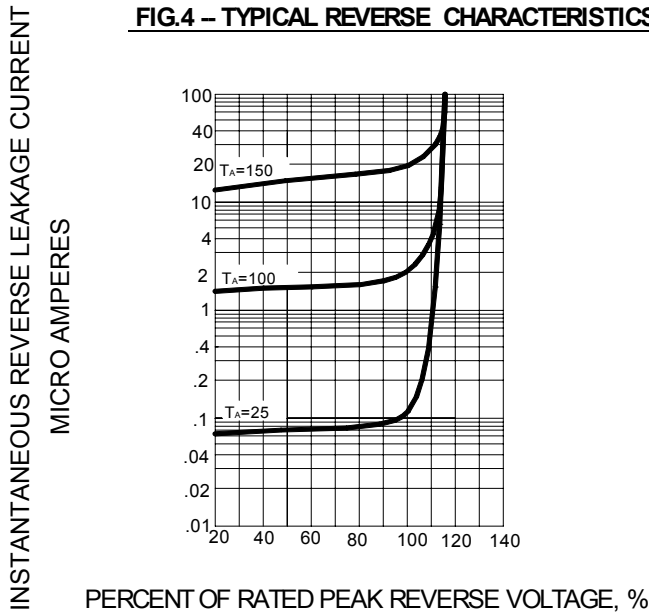

FIG.5 – PEAK FORWARD SURGE CURRENT

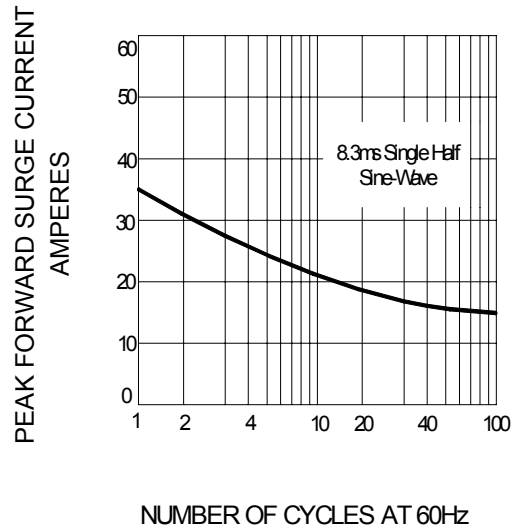
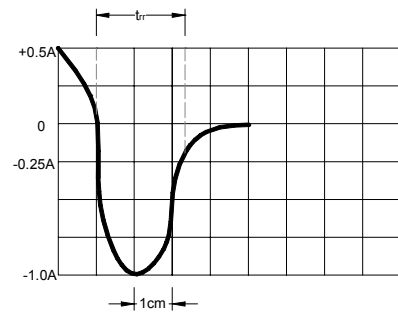
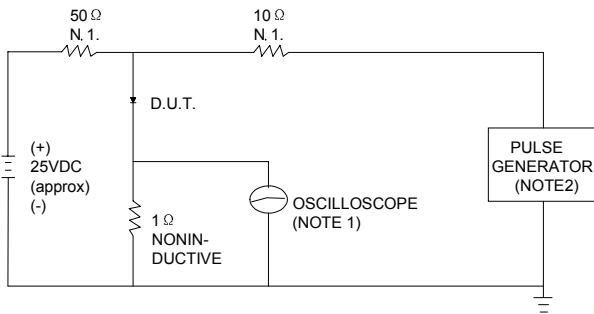

FIG.6 – TEST CIRCUIT DIAGRAM AND REVERSE RECOVERY TIME CHARACTERISTIC



NOTES: 1. RISE TIME = 7ns MAX INPUT IMPEDANCE = 1MΩ .22pF.
 2. RISE TIME = 10ns MAX SOURCE IMPEDANCE = 50Ω.

SET TIME BASE FOR 10/20 ns/cm