



FEATURES

- ◆ Wide (4:1) Input Range
- ◆ Short Circuit Protection(automatic recovery)
- ◆ 1500VDC Isolation
- ◆ Operating Temperature: -40℃~ + 85℃
- ◆ No heat sink required
- ◆ No external component required
- ◆ Internal SMD required
- ◆ Metal shielding package
- ◆ MTBF>1000Khours

MODEL SELECTION

WRB^① 24^② 05^③ Z^④ M^⑤ D^⑥ -10W^⑦

- ① Product Series
- ② Input Voltage
- ③ Output Voltage
- ④ Wide (4:1) Input Range
- ⑤ Metal Shield
- ⑥ DIP Package Style
- ⑦ Rated Power

APPLICATIONS

The WRA_ZMD-10W&WRB_ZMD-10W Series are specially designed for applications where a wide range input voltage power supplies are isolated from the input power supply in a distributed power supply system on a circuit board.

These products apply to:

- 1) Where the voltage of the input power supply is wide range (Voltage range≤4:1);
- 2) Where isolation is necessary between input and output (Isolation voltage≤1500VDC);
- 3) Where the regulation of the Output voltage and the output ripple noise are demanded.



CE REACH

MICRODC reserves the copyright

SELECTION GUIDE

Order code	Input			Output			Efficiency (% Typ)
	Voltage(VDC)			Voltage (VDC)	Current(mA)		
	Nominal	Range	Max*		Max.	Min.	
WRA2405ZMD-10W	24	9-36	40	±5	±1000	±100	84
WRA2412ZMD-10W	24	9-36	40	±12	±416	±42	81
WRA2415ZMD-10W	24	9-36	40	±15	±333	±33	83
WRB2405ZMD-10W	24	9-36	40	5	2000	200	79
WRB2412ZMD-10W	24	9-36	40	12	833	83	81
WRB2415ZMD-10W	24	9-36	40	15	666	67	81
WRA4812ZMD-10W	48	18-72	80	±12	±416	±42	85
WRA4815ZMD-10W	48	18-72	80	±15	±333	±33	83
WRB4812ZMD-10W	48	18-72	80	12	833	83	85
WRB4815ZMD-10W	48	18-72	80	15	666	67	83

*Input voltage can't exceed this value, or will cause the permanent damage.

COMMON SPECIFICATIONS

Parameter	Conditions	Min.	Typ.	Max.	Units
Storage humidity				95	%
Operating temperature		-40		85	℃
Storage temperature		-55		125	℃
Temp. rise at full load			40		℃
Lead temperature	1.5mm from case for 10 seconds			300	℃
Cooling		Free Air Convection			
Short circuit protection		Continuous, Automatic recovery			
Case material		Aluminium Alloy			
Isolation voltage	Tested for 1 minute and 1mA max	1500			VDC
Isolation resistance	Test at 500VDC	1000			MΩ
Isolation Capacitance	Input/output		1000		pF
MTBF		1000			K hours
Weight			23.5		g

TEMPERATURE CHARACTERISTICS

Parameter	Conditions	Min.	Typ.	Max.	Units
Output power	See below products program	1.0		10	W
Positive voltage accuracy	Refer to recommended circuit		±1	±3	%
Negative voltage accuracy	Refer to recommended circuit		±3	±5	%
Load regulation	Form 10% to 100% load		±0.5	±1*	%
Line regulation	Input voltage from low to high		±0.2	±0.5	%
Temperature drift (Vout)	Refer to recommended circuit			±0.03	%/°C
Ripple**	20MHz Bandwidth		20	50	mVp-p
Noise**	20MHz Bandwidth		75	150	mVp-p
Switching frequency	100% load, input voltage range		300		KHz

* Dual output models unbalanced load: ±5%.

** Test ripple and noise by "parallel cable" method. See detailed operation instructions at Testing of Power Converter section, application notes.

APPLICATION NOTE

Requirement on output load

In order to ensure the product operate efficiently and reliably, in addition to a max load (namely full load), a minimum load is specified for this kind of DC/DC converter. Make sure the specified range of input voltage is not exceeded, the minimum output load no less than 10% load. If the actual load is less than the specified minimum load, the output ripple may increase sharply while its efficiency and reliability will reduce greatly. If the actual output power is very small, please add an appropriate resistor as extra loading, or contact our company for other lower output power products.

Recommended Circuit

All the WRA_ZMD-10W & WRB_ZMD-10W Series have been tested according to the following recommended testing circuit before leaving factory. This series should be tested under load (see Figure 1).

If you want to further decrease the input/output ripple, you can increase capacitance properly or choose capacitors with low ESR. However, the capacitance of the output filter capacitor must be proper. If the capacitance is too big, a startup problem might arise. For every channel of output, provided the safe and reliable operation is ensured, the greatest capacitance of its filter capacitor sees (Table 1). General:

$$\begin{aligned} \text{Cin: } & 10\mu\text{F}-47\mu\text{F} \\ \text{Cout: } & 10\mu\text{F}/100\text{mA} \end{aligned}$$

CTRL Terminal

When open or high impedance, the converter work well; When this pin is 'high', the converter shutdown; It should be note that the input current (Ic) should between 5-10mA, exceeding the maximum 20mA will cause permanence damage to the converter.

The value of R Can be derived as follows :

$$R = \frac{Vc - Vd - 1.0}{Ic}$$

Input current

While using unstable power source, please ensure the output voltage and ripple voltage do not exceed indexes of the converter. The preceding power source must be able to provide for converter sufficient starting current Ip (Figure 2).

General: $I_p \leq 1.6 * I_{in-max}$

No parallel connection or plug and play

TYPICAL CHARACTERISTICS

Temperature Derating Graph

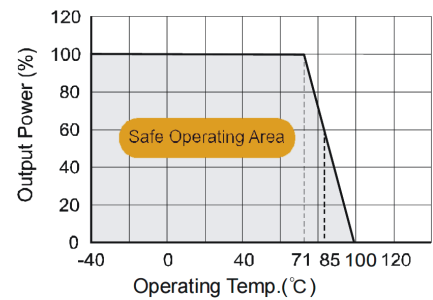

RECOMMENDED CIRCUIT

Output Graph

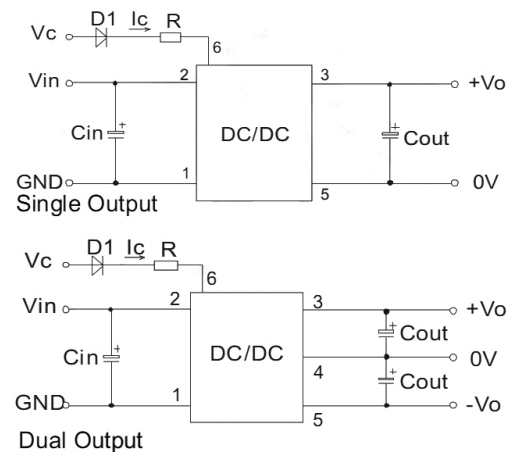

(Figure 1)

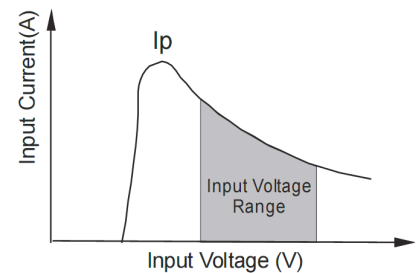

(Figure 2)

Output External Capacitor Table (Table 1)

Single Vout (VDC)	Cout (μF)	Dual Vout (VDC)	Cout (μF)
5	680	±5	680
12	470	±12	330
15	330	±15	220

OUTLINE DIMENSIONS & FOOTPRINT DETAILS

MECHANICAL DIMENSIONS

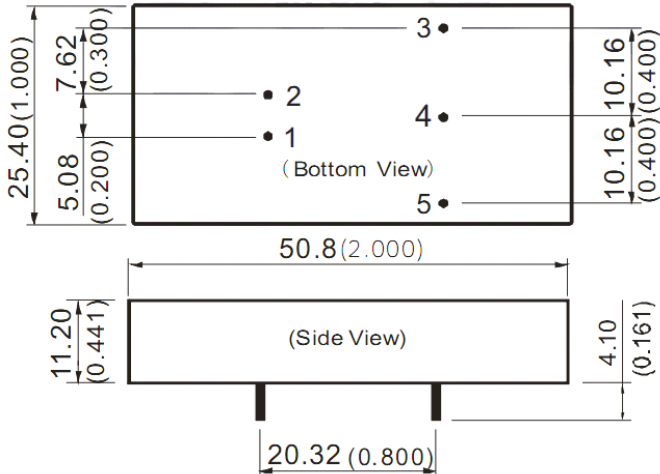

Note:
 Unit:mm[inch]
 Pin section tolerances:±0.10mm[±0.004inch]
 General tolerances:±0.25mm[±0.010inch]

FOOTPRINT DETAILS

Pin	Single	Dual
1	GND	GND
2	Vin	Vin
3	+Vo	+Vo
4	NC	0V
5	0V	-Vo

NC:No connection

When the environment temperature is higher than 71°C, the product output power should be less than 60% of the rated power.

No parallel connection or plug and play.

Use dual output simultaneously,forbid pening output pin (0V) to use as single output.

Note:

1. The load shouldn't be less than 10%, otherwise ripple will increase dramatically.
2. Operation under 10% load will not damage the converter; However, they may not meet all specification listed.
3. All specifications measured at Ta=25°C, humidity<75%, nominal input voltage and rated output load unless otherwise specified.
4. In this datasheet, all the test methods of indications are based on corporate standards.
5. Only typical models listed, other models may be different, please contact our technical person for more details.

RECOMMENDED FOOTPRINT

Dual Output

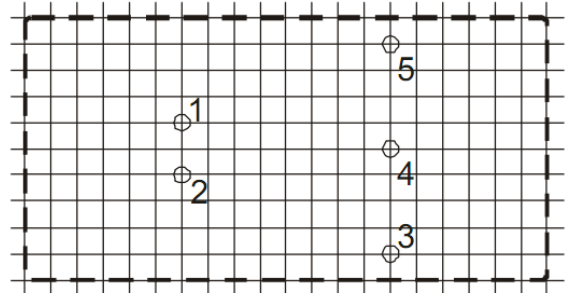

Single Output

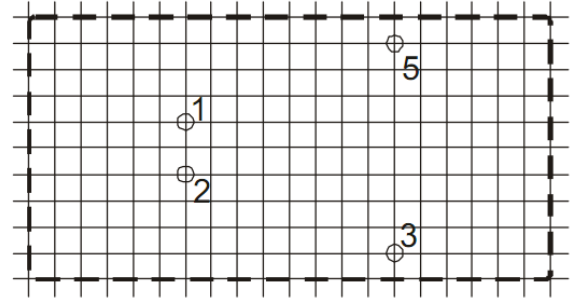

RECOMMENDED FOOTPRINT

Top view, grid:2.54mm(0.1inch)
 diameter:1.00mm(0.039inch)

TUBE OUTLINE DIMENSIONS

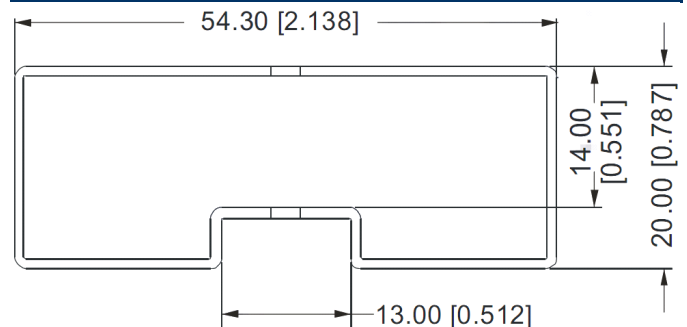

Unit :mm[inch]

General tolerances:±0.50mm[±0.020inch]

L=230mm[9.055inch] Tube Quantity: 7pcs