



TO-252-2L Plastic-Encapsulate Voltage Regulators

CJ78M05 Three-terminal positive voltage regulator

FEATURES

- Maximum output current
 I_{OM} : 0.5 A
- Output voltage
 V_O : 5V
- Continuous total dissipation
 P_D : 1.25 W ($T_a=25\text{ }^\circ\text{C}$)

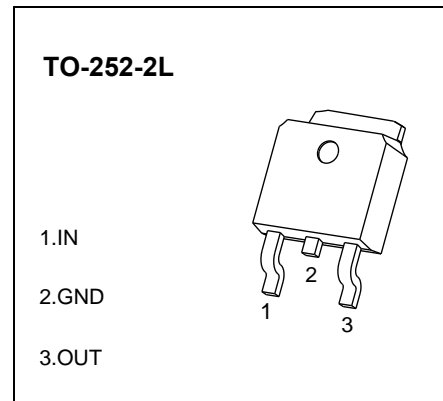

MARKING

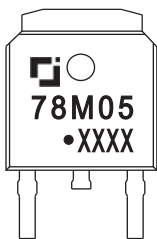

78M05=Device code
Solid dot = Green molding compound device
if none, the normal device.
XXXX = Code

ABSOLUTE MAXIMUM RATINGS (Operating temperature range applies unless otherwise specified)

Parameter	Symbol	Value	Unit
Input Voltage	V_i	35	V
Thermal Resistance from Junction to Ambient	$R_{\theta JA}$	80	$^\circ\text{C}/\text{W}$
Operating Junction Temperature Range	T_{OPR}	-40~+125	$^\circ\text{C}$
Storage Temperature Range	T_{STG}	-65~+150	$^\circ\text{C}$

Electrical Characteristics

ELECTRICAL CHARACTERISTICS AT SPECIFIED VIRTUAL JUNCTION TEMPERATURE ($V_i=10V, I_o=350mA, C_i=0.33\mu F, C_o=0.1\mu F$, unless otherwise specified)

Parameter	Symbol	Test conditions	Min	Typ	Max	Unit
Output Voltage	V_o	$T_J=25\text{ }^\circ\text{C}$	4.85	5	5.15	V
		$7V \leq V_i \leq 20V, I_o=5mA-350mA$	4.75	5	5.25	V
Load Regulation	ΔV_o	$I_o=5mA-0.5A, T_J=25\text{ }^\circ\text{C}$		15	100	mV
		$I_o=5mA-200mA, T_J=25\text{ }^\circ\text{C}$		5	50	mV
Line Regulation	ΔV_o	$7V \leq V_i \leq 25V, I_o=200mA, T_J=25\text{ }^\circ\text{C}$		3	100	mV
		$8V \leq V_i \leq 25V, I_o=200mA, T_J=25\text{ }^\circ\text{C}$		1	50	mV
Quiescent Current	I_q	$T_J=25\text{ }^\circ\text{C}$		4.2	6	mA
Quiescent Current Change	ΔI_q	$8V \leq V_i \leq 25V, I_o=200mA$			0.8	mA
	ΔI_q	$5mA \leq I_o \leq 350mA$			0.5	mA
Output Noise Voltage	V_N	$10Hz \leq f \leq 100KHz, T_J=25\text{ }^\circ\text{C}$		40	200	$\mu V/V_o$
Ripple Rejection	RR	$8V \leq V_i \leq 18V, f=120Hz, I_o=300mA$	62	80		dB
Dropout Voltage	V_d	$I_o=350mA, T_J=25\text{ }^\circ\text{C}$		2	2.5	V
Short Circuit Current	I_{sc}	$V_i=10V, T_J=25\text{ }^\circ\text{C}$		300		mA
Peak Current	I_{pk}	$T_J=25\text{ }^\circ\text{C}$		0.5		A

* Pulse test.

TYPICAL APPLICATION

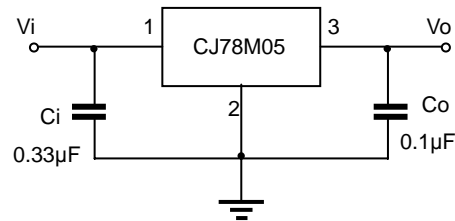

Note: Bypass capacitors are recommended for optimum stability and transient response and should be located as close as possible to the regulators.

Typical Characteristics

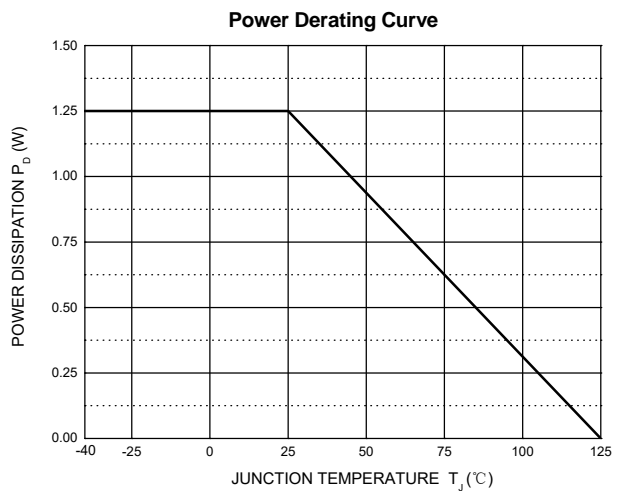
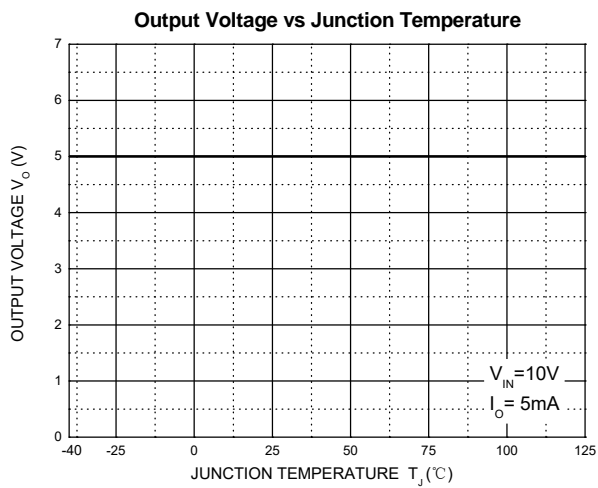
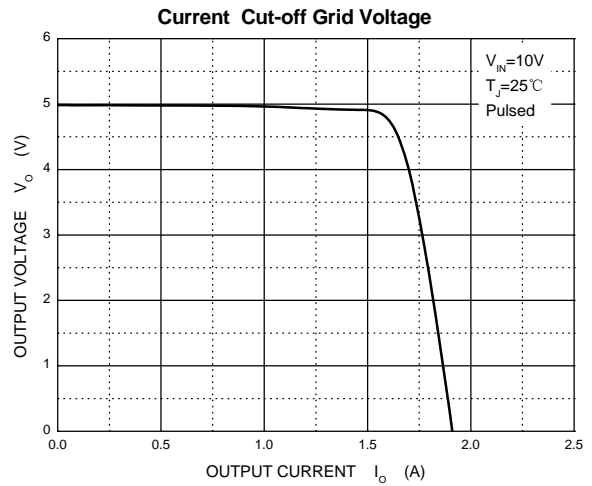
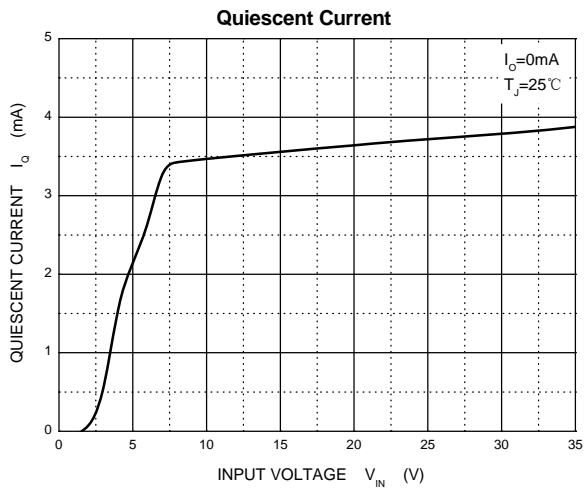
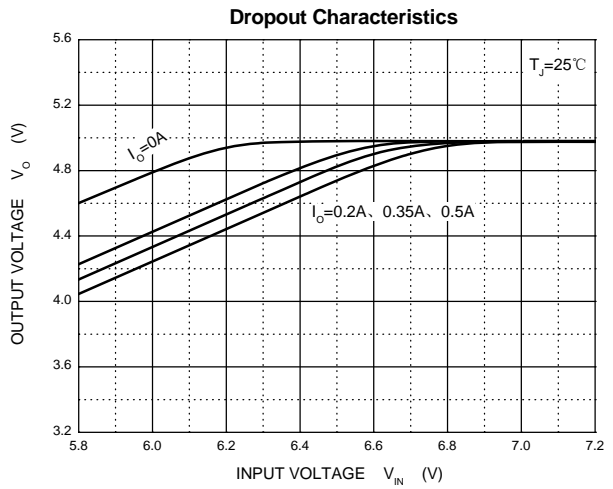
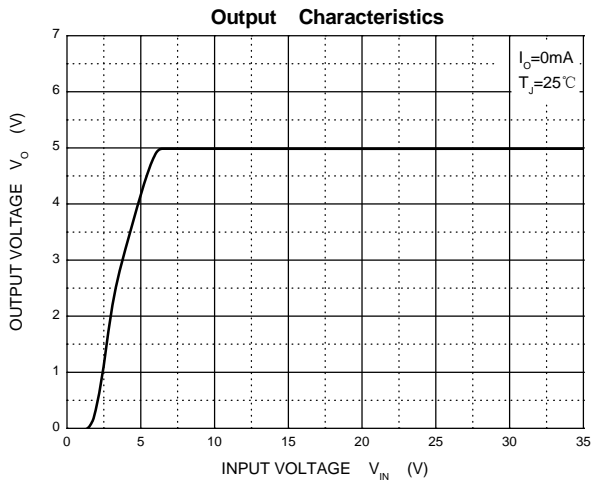

TO-252-2L Package Outline Dimensions

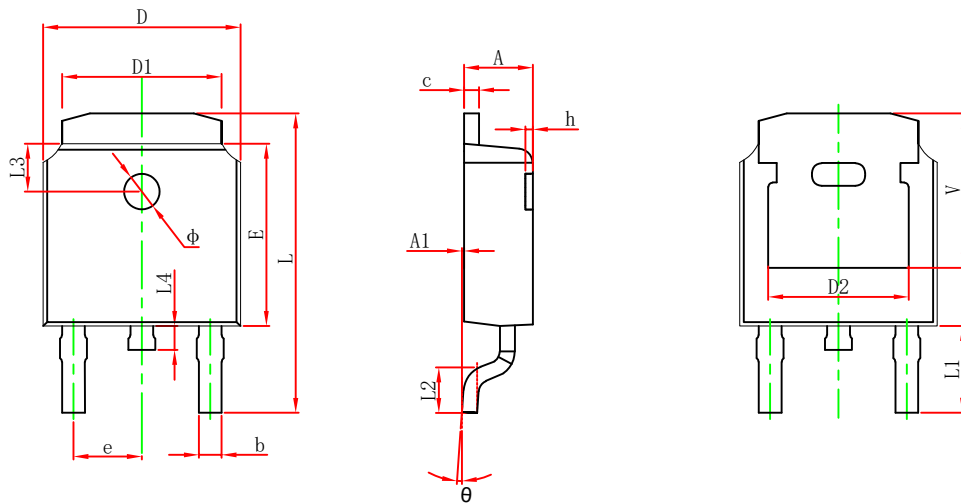

Symbol	Dimensions In Millimeters		Dimensions In Inches	
	Min.	Max.	Min.	Max.
A	2.200	2.400	0.087	0.094
A1	0.000	0.127	0.000	0.005
b	0.635	0.770	0.025	0.030
c	0.460	0.580	0.018	0.023
D	6.500	6.700	0.256	0.264
D1	5.100	5.460	0.201	0.215
D2	4.830 REF.		0.190 REF.	
E	6.000	6.200	0.236	0.244
e	2.186	2.386	0.086	0.094
L	9.712	10.312	0.382	0.406
L1	2.900 REF.		0.114 REF.	
L2	1.400	1.700	0.055	0.067
L3	1.600 REF.		0.063 REF.	
L4	0.600	1.000	0.024	0.039
φ	1.100	1.300	0.043	0.051
θ	0°	8°	0°	8°
h	0.000	0.300	0.000	0.012
V	5.250 REF.		0.207 REF.	

TO-252-2L Suggested Pad Layout

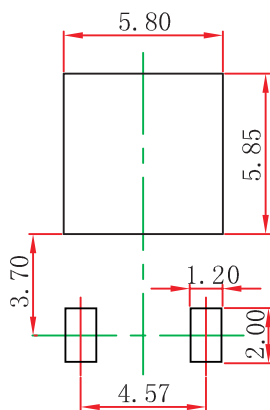

- Note:
1. Controlling dimension: in millimeters.
 2. General tolerance: ± 0.05 mm.
 3. The pad layout is for reference purposes only.

TO-252-2L Tape and Reel

TO-252 Embossed Carrier Tape

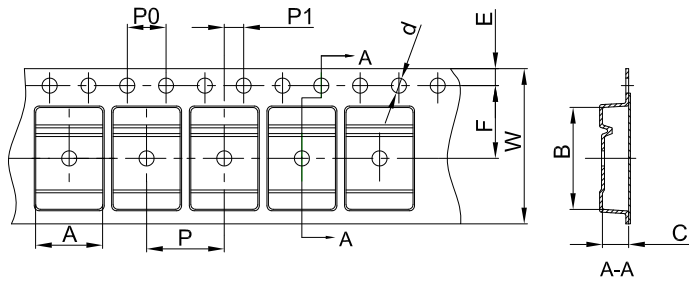

Packaging Description:

TO-252 parts are shipped in tape. The carrier tape is made from a dissipative (carbon filled) polycarbonate resin. The cover tape is a multilayer film (Heat Activated Adhesive in nature) primarily composed of polyester film, adhesive layer, sealant, and anti-static sprayed agent. These reeled parts in standard option are shipped with 25,00 units per 13" or 33.0 cm diameter reel. The reels are clear in color and is made of polystyrene plastic (anti-static coated).

Dimensions are in millimeter										
Pkg type	A	B	C	d	E	F	P0	P	P1	W
TO-252	6.90	10.50	2.70	Ø1.55	1.75	7.50	4.00	8.00	2.00	16.00

TO-252 Tape Leader and Trailer

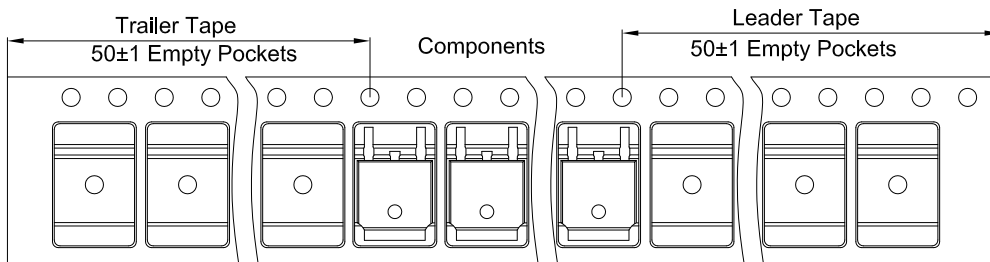

TO-252 Reel

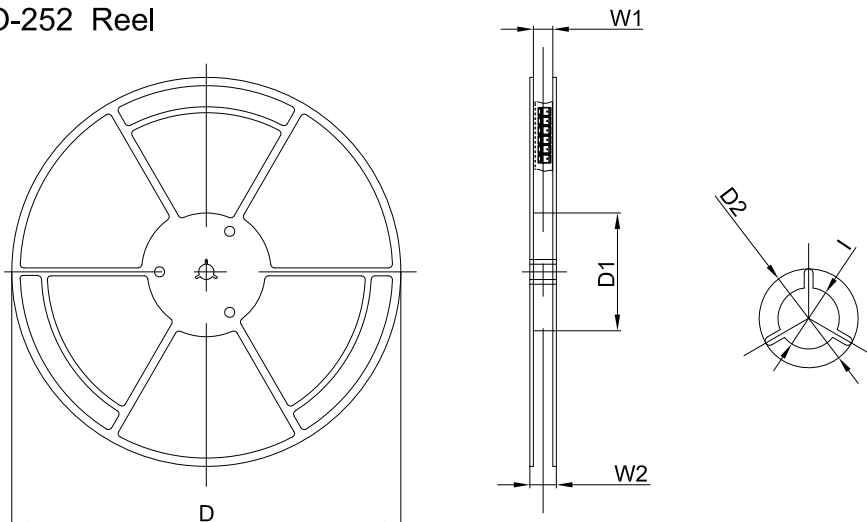

Dimensions are in millimeter						
Reel Option	D	D1	D2	W1	W2	I
13" Dia	330.00	100.00	Ø21.00	16.40	21.00	Ø13.00

REEL	Reel Size	Box	Box Size(mm)	Carton	Carton Size(mm)	G.W.(kg)
2,500 pcs	13inch	2,500 pcs	340×336×29	25,000 pcs	353×346×365	

DISCLAIMER

IMPORTANT NOTICE, PLEASE READ CAREFULLY

The information in this data sheet is intended to describe the operation and characteristics of our products. JSCJ has the right to make any modification, enhancement, improvement, correction or other changes to any content in this data sheet, including but not limited to specification parameters, circuit design and application information, without prior notice.

Any person who purchases or uses JSCJ products for design shall: 1. Select products suitable for circuit application and design; 2. Design, verify and test the rationality of circuit design; 3. Procedures to ensure that the design complies with relevant laws and regulations and the requirements of such laws and regulations. JSCJ makes no warranty or representation as to the accuracy or completeness of the information contained in this data sheet and assumes no responsibility for the application or use of any of the products described in this data sheet.

Without the written consent of JSCJ, this product shall not be used in occasions requiring high quality or high reliability, including but not limited to the following occasions: medical equipment, automotive electronics, military facilities and aerospace. JSCJ shall not be responsible for casualties or property losses caused by abnormal use or application of this product.

Official Website: www.jscj-elec.com

Copyright © JIANGSU CHANGJING ELECTRONICS TECHNOLOGY CO., LTD.