

FR101 – FR107

1.0A FAST RECOVERY RECTIFIER

Features

- Diffused Junction
- Low Forward Voltage Drop
- High Current Capability
- High Reliability
- High Surge Current Capability

Mechanical Data

- Case: Molded Plastic
- Terminals: Plated Leads Solderable per MIL-STD-202, Method 208
- Polarity: Cathode Band
- Weight: 0.34 grams (approx.)
- Mounting Position: Any
- Marking: Type Number



DO-41		
Dim	Min	Max
A	25.4	—
B	4.06	5.21
C	0.71	0.864
D	2.00	2.72
All Dimensions in mm		

Maximum Ratings and Electrical Characteristics @ $T_A=25^\circ\text{C}$ unless otherwise specified

Single Phase, half wave, 60Hz, resistive or inductive load.
 For capacitive load, derate current by 20%.

Characteristic	Symbol	FR101	FR102	FR103	FR104	FR105	FR106	FR107	Unit
Peak Repetitive Reverse Voltage	V_{RRM}								V
Working Peak Reverse Voltage	V_{RWM}	50	100	200	400	600	800	1000	
DC Blocking Voltage	V_R								
RMS Reverse Voltage	$V_{R(RMS)}$	35	70	140	280	420	560	700	V
Average Rectified Output Current (Note 1)	I_O	1.0							A
Non-Repetitive Peak Forward Surge Current 8.3ms Single half sine-wave superimposed on rated load (JEDEC Method)	I_{FSM}	30							A
Forward Voltage @ $I_F = 1.0\text{A}$	V_{FM}	1.2							V
Peak Reverse Current @ $T_A = 25^\circ\text{C}$ At Rated DC Blocking Voltage @ $T_A = 100^\circ\text{C}$	I_{RM}	5.0 100							μA
Reverse Recovery Time (Note 2)	t_{rr}	150				250	500		nS
Typical Junction Capacitance (Note 3)	C_j	15							pF
Operating Temperature Range	T_j	-65 to +125							$^\circ\text{C}$
Storage Temperature Range	T_{STG}	-65 to +150							$^\circ\text{C}$

***Glass passivated forms are available upon request**

- Note: 1. Leads maintained at ambient temperature at a distance of 9.5mm from the case
 2. Measured with $I_F = 0.5\text{A}$, $I_R = 1.0\text{A}$, $IRR = 0.25\text{A}$. See figure 5.
 3. Measured at 1.0 MHz and applied reverse voltage of 4.0V D.C.

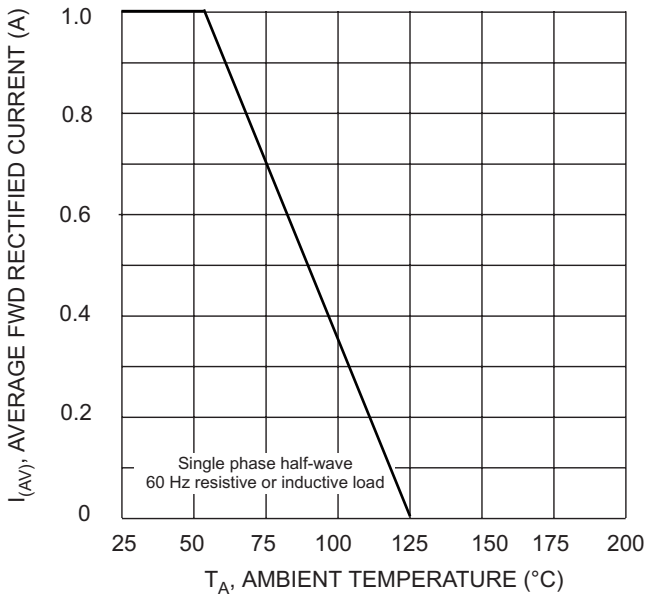

Fig. 1 Forward Derating Curve

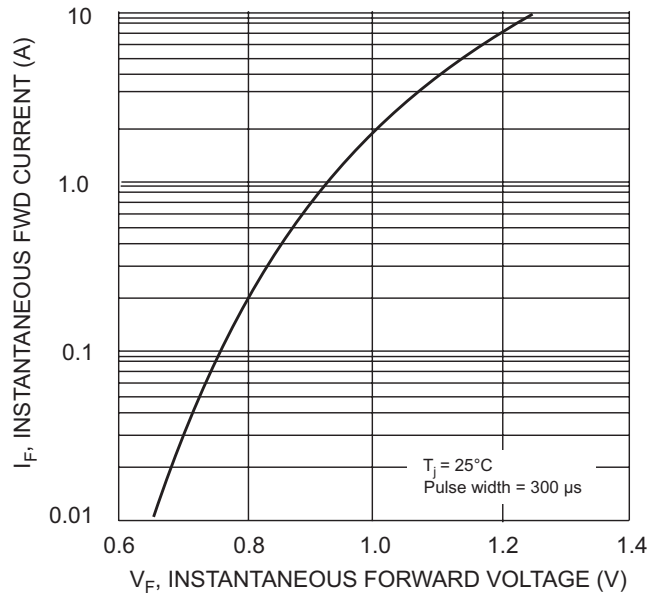

Fig. 2 Typical Forward Characteristics

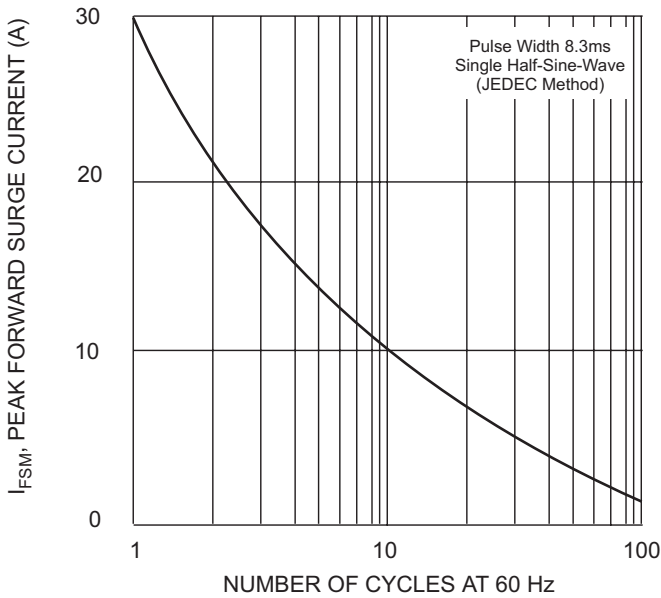

Fig. 3 Peak Forward Surge Current

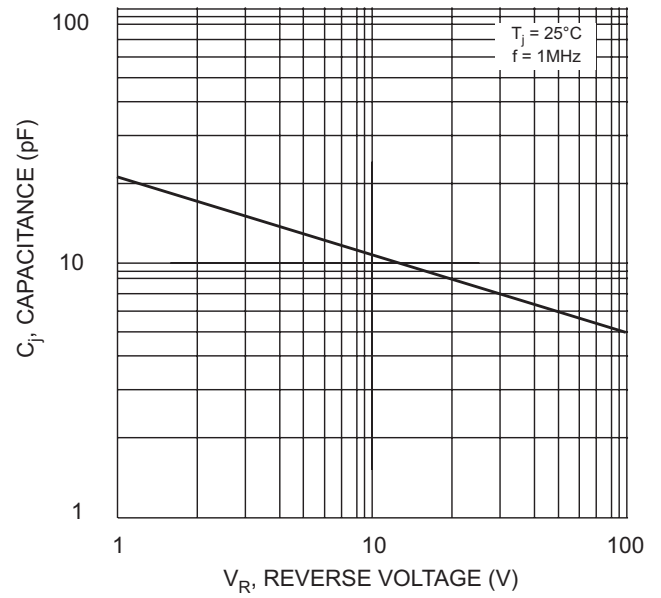
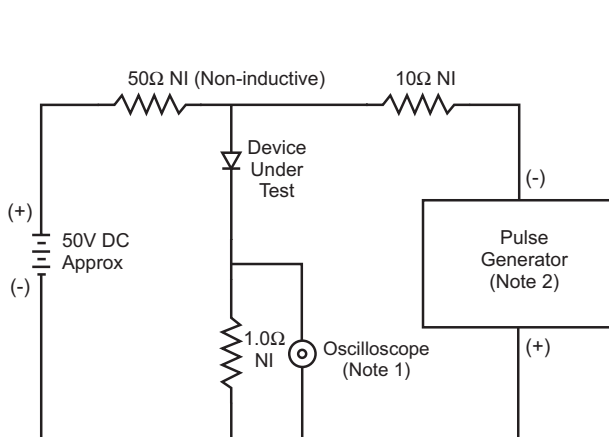
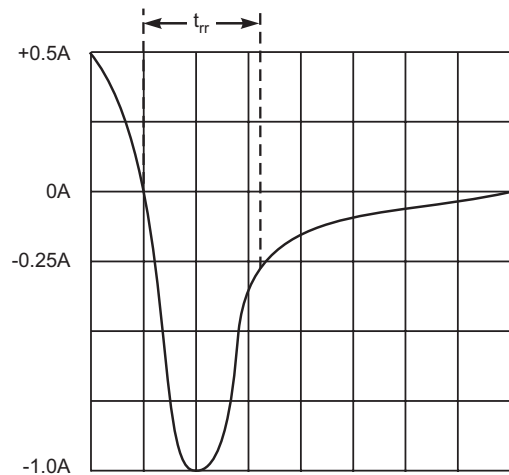

Fig. 4 Typical Junction Capacitance



- Notes:
1. Rise Time = 7.0ns max. Input Impedance = 1.0MΩ, 22pF.
 2. Rise Time = 10ns max. Input Impedance = 50Ω.



Set time base for 5/10ns/cm

Fig. 5 Reverse Recovery Time Characteristic and Test Circuit

ORDERING INFORMATION

Product No.◆	Package Type	Shipping Quantity
FR101-T3	DO-41	5000/Tape & Reel
FR101-TB	DO-41	5000/Tape & Box
FR101	DO-41	1000 Units/Box
FR102-T3	DO-41	5000/Tape & Reel
FR102-TB	DO-41	5000/Tape & Box
FR102	DO-41	1000 Units/Box
FR103-T3	DO-41	5000/Tape & Reel
FR103-TB	DO-41	5000/Tape & Box
FR103	DO-41	1000 Units/Box
FR104-T3	DO-41	5000/Tape & Reel
FR104-TB	DO-41	5000/Tape & Box
FR104	DO-41	1000 Units/Box
FR105-T3	DO-41	5000/Tape & Reel
FR105-TB	DO-41	5000/Tape & Box
FR105	DO-41	1000 Units/Box
FR106-T3	DO-41	5000/Tape & Reel
FR106-TB	DO-41	5000/Tape & Box
FR106	DO-41	1000 Units/Box
FR107-T3	DO-41	5000/Tape & Reel
FR107-TB	DO-41	5000/Tape & Box
FR107	DO-41	1000 Units/Box

Products listed in **bold** are WTE **Preferred** devices.

◆T3 suffix refers to a 13" reel. TB suffix refers to Ammo Pack.

Shipping quantity given is for minimum packing quantity only. For minimum order quantity, please consult the Sales Department.

Won-Top Electronics Co., Ltd (WTE) has checked all information carefully and believes it to be correct and accurate. However, WTE cannot assume any responsibility for inaccuracies. Furthermore, this information does not give the purchaser of semiconductor devices any license under patent rights to manufacturer. WTE reserves the right to change any or all information herein without further notice.

WARNING: DO NOT USE IN LIFE SUPPORT EQUIPMENT. WTE power semiconductor products are not authorized for use as critical components in life support devices or systems without the express written approval.

Won-Top Electronics Co., Ltd.

No. 44 Yu Kang North 3rd Road, Chine Chen Dist., Kaohsiung, Taiwan

Phone: 886-7-822-5408 or 886-7-822-5410

Fax: 886-7-822-5417

Email: sales@wontop.com

Internet: http://www.wontop.com

We power your everyday.