

## Dual Low Noise Amplifier

The EL2228 is a dual, low-noise amplifier, ideally suited to filtering applications in ADSL and HDSLII designs. It features low noise specification of just  $4.9\text{nV}/\sqrt{\text{Hz}}$  and  $1.2\text{pA}/\sqrt{\text{Hz}}$ , making it ideal for processing low voltage waveforms.

The EL2228 has a -3dB bandwidth of 80MHz and is gain-of-1 stable. It also affords minimal power dissipation with a supply current of just 4.5mA per amplifier. The amplifier can be powered from supplies ranging from  $\pm 2.5\text{V}$  to  $\pm 12\text{V}$ .

The EL2228 is available in a space saving 8-pin MSOP package as well as the industry-standard 8-pin SO. It is specified for operation over the  $-40^\circ\text{C}$  to  $+85^\circ\text{C}$  temperature range.

## Ordering Information

PART NUMBER	PACKAGE	TAPE & REEL	PKG. DWG. #
EL2228CY	8-Pin MSOP	-	MDP0043
EL2228CY-T13	8-Pin MSOP	13"	MDP0043
EL2228CY-T7	8-Pin MSOP	7"	MDP0043
EL2228CYZ (See Note)	8-Pin MSOP (Pb-free)	-	MDP0043
EL2228CYZ-T13 (See Note)	8-Pin MSOP (Pb-free)	13"	MDP0043
EL2228CYZ-T7 (See Note)	8-Pin MSOP (Pb-free)	7"	MDP0043
EL2228CS	8-Pin SO	-	MDP0027
EL2228CS-T13	8-Pin SO	13"	MDP0027
EL2228CS-T7	8-Pin SO	7"	MDP0027
EL2228CSZ (See Note)	8-Pin SO (Pb-free)	-	MDP0027
EL2228CSZ-T13 (See Note)	8-Pin SO (Pb-free)	13"	MDP0027
EL2228CSZ-T7 (See Note)	8-Pin SO (Pb-free)	7"	MDP0027

NOTE: Intersil Pb-free products employ special Pb-free material sets; molding compounds/die attach materials and 100% matte tin plate termination finish, which are RoHS compliant and compatible with both SnPb and Pb-free soldering operations. Intersil Pb-free products are MSL classified at Pb-free peak reflow temperatures that meet or exceed the Pb-free requirements of IPC/JEDEC J STD-020.

## Features

- Voltage noise of only  $4.9\text{nV}/\sqrt{\text{Hz}}$
- Current noise of only  $1.2\text{pA}/\sqrt{\text{Hz}}$
- Bandwidth (-3dB) of 80MHz - @  $A_V = +1$
- Gain-of-1 stable
- Just 4.5mA per amplifier
- 8-pin MSOP package
- $\pm 2.5\text{V}$  to  $\pm 12\text{V}$  operation
- Pb-Free available (RoHS compliant)

## Applications

- ADSL filters
- HDSLII filters
- Ultrasound input amplifiers
- Wideband instrumentation
- Communications equipment
- Wideband sensors

## Pinout

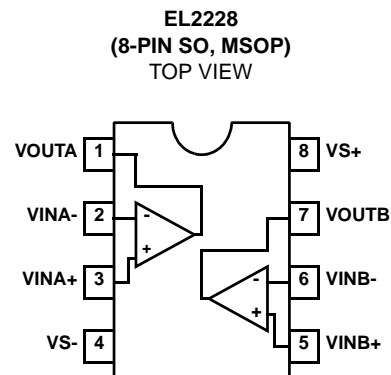

**Absolute Maximum Ratings** ( $T_A = 25^\circ\text{C}$ )

Supply Voltage between $V_{S+}$ and $V_{S-}$ . . . . .	+28V	Maximum Die Temperature . . . . .	+150°C
Input Voltage . . . . .	$V_{S-} - 0.3\text{V}, V_{S+} + 0.3\text{V}$	Storage Temperature . . . . .	-65°C to +150°C
Maximum Continuous Output Current . . . . .	40mA	Power Dissipation . . . . .	See Curves
ESD Voltage . . . . .	.2kV	Operating Temperature . . . . .	-40°C to +85°C

*CAUTION: Stresses above those listed in "Absolute Maximum Ratings" may cause permanent damage to the device. This is a stress only rating and operation of the device at these or any other conditions above those indicated in the operational sections of this specification is not implied.*

NOTE: All parameters having Min/Max specifications are guaranteed. Typ values are for information purposes only. Unless otherwise noted, all tests are at the specified temperature and are pulsed tests, therefore:  $T_J = T_C = T_A$

**Electrical Specifications**  $V_{S+} = +12\text{V}, V_{S-} = -12\text{V}, R_L = 500\Omega$  and  $C_L = 3\text{pF}$  to  $0\text{V}, R_F = 420\Omega$  and  $T_A = 25^\circ\text{C}$  unless otherwise specified.

PARAMETER	DESCRIPTION	CONDITIONS	MIN	TYP	MAX	UNIT
<b>INPUT CHARACTERISTICS</b>						
$V_{OS}$	Input Offset Voltage	$V_{CM} = 0\text{V}$		0.2	3	mV
$TCV_{OS}$	Average Offset Voltage Drift	Measured over operating temperature range		-4		$\mu\text{V}/^\circ\text{C}$
$I_B$	Input Bias Current	$V_{CM} = 0\text{V}$	-9	-4.5	-1	$\mu\text{A}$
$R_{IN}$	Input Impedance			8		$\text{M}\Omega$
$C_{IN}$	Input Capacitance			1		pF
CMIR	Common-Mode Input Range		-11.8		+10.4	V
CMRR	Common-Mode Rejection Ratio	for $V_{IN}$ from -11.8V to +10.4V	60	90		dB
		for $V_{IN}$ from -10V to +10V	60	75		dB
$A_{VOL}$	Open-Loop Gain	$-5\text{V} \leq V_{OUT} \leq 5\text{V}$	60	75		dB
$e_N$	Voltage Noise	$f = 100\text{kHz}$		4.9		$\text{nV}/\sqrt{\text{Hz}}$
$i_N$	Current Noise	$f = 100\text{kHz}$		1.2		$\text{pA}/\sqrt{\text{Hz}}$
<b>OUTPUT CHARACTERISTICS</b>						
$V_{OL}$	Output Swing Low	$R_L = 500\Omega$		-10.3	-10	V
		$R_L = 250\Omega$		-9.5	-9	V
$V_{OH}$	Output Swing High	$R_L = 500\Omega$	10	10.3		V
		$R_L = 250\Omega$	9.5	10		V
$I_{SC}$	Short Circuit Current	$R_L = 10\Omega$	140	180		mA
<b>POWER SUPPLY PERFORMANCE</b>						
PSRR	Power Supply Rejection Ratio	$V_S$ is moved from $\pm 10.8\text{V}$ to $\pm 13.2\text{V}$	65	83		dB
$I_S$	Supply Current (per Amplifier)	No load	4	5	6	mA
<b>DYNAMIC PERFORMANCE</b>						
SR	Slew Rate (Note 1)	$\pm 2.5\text{V}$ square wave, measured 25%-75%	44	65		$\text{V}/\mu\text{s}$
$t_S$	Settling to +0.1% ( $A_V = +1$ )	( $A_V = +1$ ), $V_O = 2\text{V}$ step		50		ns
BW	-3dB Bandwidth			80		MHz
HD2	2nd Harmonic Distortion	$f = 1\text{MHz}, V_O = 2V_{P-P}, R_L = 500\Omega, A_V = 2$		-86		dBc
		$f = 1\text{MHz}, V_O = 2V_{P-P}, R_L = 150\Omega, A_V = 2$		-79		dBc
HD3	3rd Harmonic Distortion	$f = 1\text{MHz}, V_O = 2V_{P-P}, R_L = 500\Omega, A_V = 2$		-93		dBc
		$f = 1\text{MHz}, V_O = 2V_{P-P}, R_L = 150\Omega, A_V = 2$		-70		dBc

NOTE:

1. Slew rate is measured on rising and falling edges

**Electrical Specifications**  $V_{S+} = +5V$ ,  $V_{S-} = -5V$ ,  $R_L = 500\Omega$  and  $C_L = 3pF$  to  $0V$ ,  $R_F = 420\Omega$  and  $T_A = 25^\circ C$  unless otherwise specified.

PARAMETER	DESCRIPTION	CONDITIONS	MIN	TYP	MAX	UNIT
<b>INPUT CHARACTERISTICS</b>						
$V_{OS}$	Input Offset Voltage	$V_{CM} = 0V$		0.6	3	mV
$TCV_{OS}$	Average Offset Voltage Drift	Measured over operating temperature range		4.9		$\mu V/^\circ C$
$I_B$	Input Bias Current	$V_{CM} = 0V$	-9	-4.5	-1	$\mu A$
$R_{IN}$	Input Impedance			6		$M\Omega$
$C_{IN}$	Input Capacitance			1.2		pF
CMIR	Common-Mode Input Range		-4.7		+3.4	V
CMRR	Common-Mode Rejection Ratio	for $V_{IN}$ from -4.7V to +3.4V	60	90		dB
		for $V_{IN}$ from -2V to +2V				dB
$A_{VOL}$	Open-Loop Gain	$-2.5V \leq V_{OUT} \leq 2.5V$	60	72		dB
$e_N$	Voltage Noise	$f = 100kHz$		4.7		$nV/\sqrt{Hz}$
$i_N$	Current Noise	$f = 100kHz$		1.2		$pA/\sqrt{Hz}$
<b>OUTPUT CHARACTERISTICS</b>						
$V_{OL}$	Output Swing Low	$R_L = 500\Omega$		-3.8	-3.5	V
		$R_L = 250\Omega$		-3.7	-3.5	V
$V_{OH}$	Output Swing High	$R_L = 500\Omega$	3.5	3.7		V
		$R_L = 250\Omega$	3.5	3.6		V
$I_{SC}$	Short Circuit Current	$R_L = 10\Omega$	60	100		mA
<b>POWER SUPPLY PERFORMANCE</b>						
PSRR	Power Supply Rejection Ratio	$V_S$ is moved from $\pm 4.5V$ to $\pm 5.5V$	65	83		dB
$I_S$	Supply Current (Per Amplifier)	No load	3.5	4.5	5.5	mA
<b>DYNAMIC PERFORMANCE</b>						
SR	Slew Rate (Note 1)	$\pm 2.5V$ square wave, measured 25%-75%	35	50		$V/\mu s$
$t_S$	Settling to +0.1% ( $A_V = +1$ )	( $A_V = +1$ ), $V_O = 2V$ step		50		ns
BW	-3dB Bandwidth			75		MHz
HD2	2nd Harmonic Distortion	$f = 1MHz$ , $V_O = 2V_{P-P}$ , $R_L = 500\Omega$ , $A_V = 2$		-90		dBc
		$f = 1MHz$ , $V_O = 2V_{P-P}$ , $R_L = 150\Omega$ , $A_V = 2$		-71		dBc
HD3	3rd Harmonic Distortion	$f = 1MHz$ , $V_O = 2V_{P-P}$ , $R_L = 500\Omega$ , $A_V = 2$		-99		dBc
		$f = 1MHz$ , $V_O = 2V_{P-P}$ , $R_L = 150\Omega$ , $A_V = 2$		-69		dBc

NOTE:

1. Slew rate is measured on rising and falling edges

Typical Performance Curves

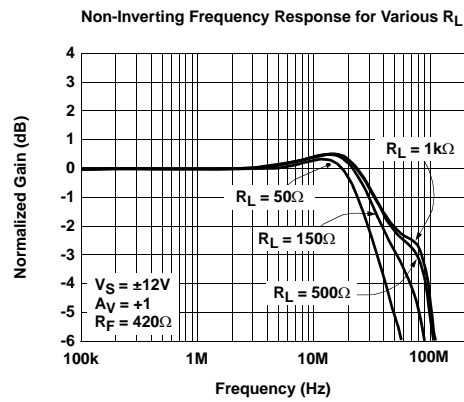
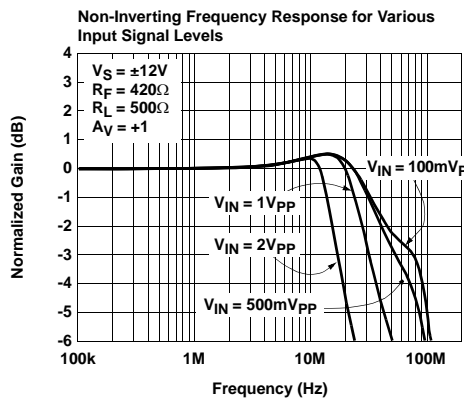
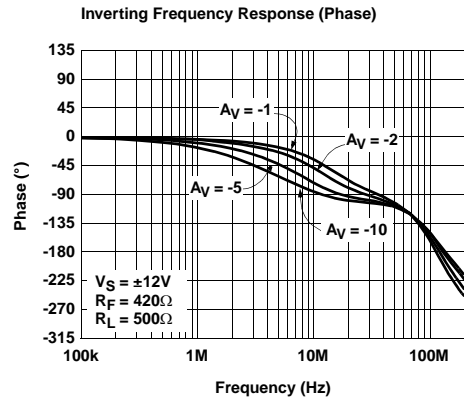
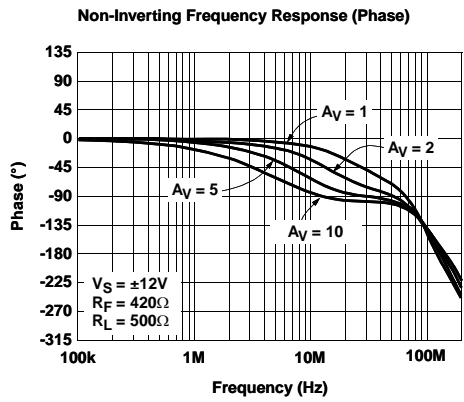
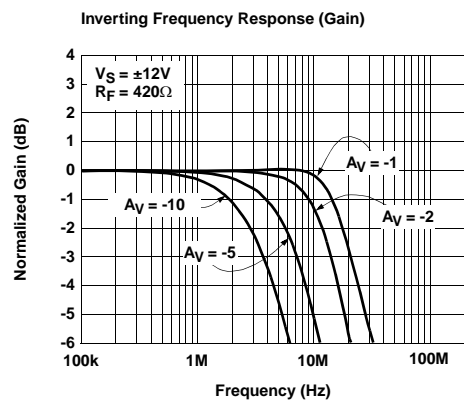
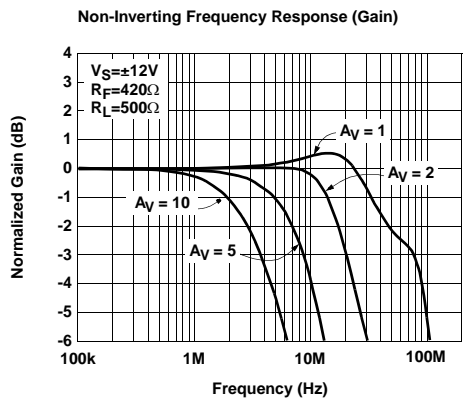
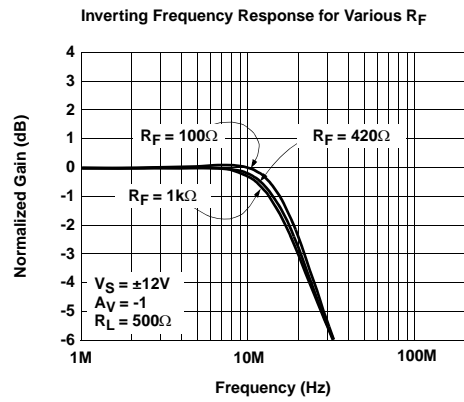
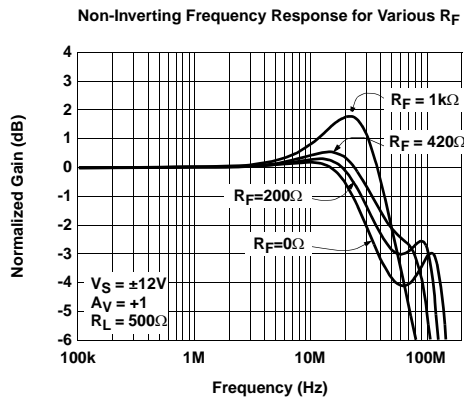

Typical Performance Curves (Continued)

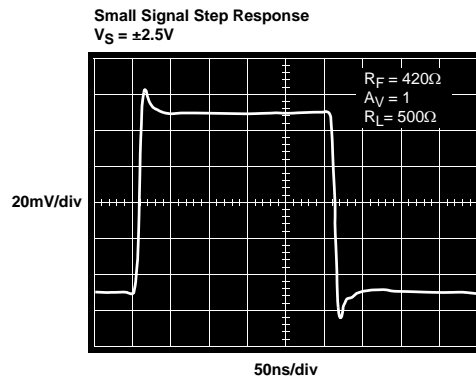
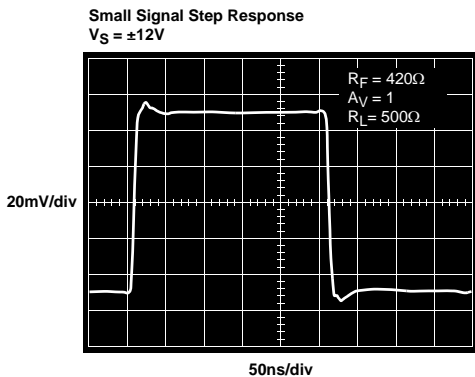
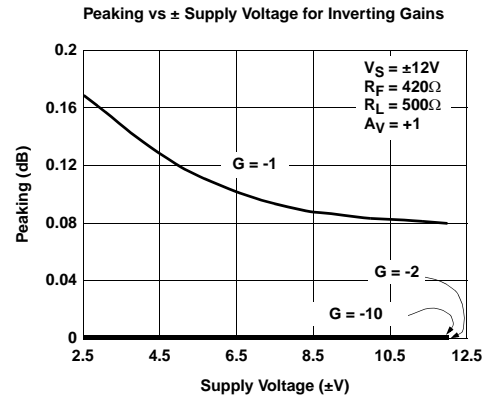
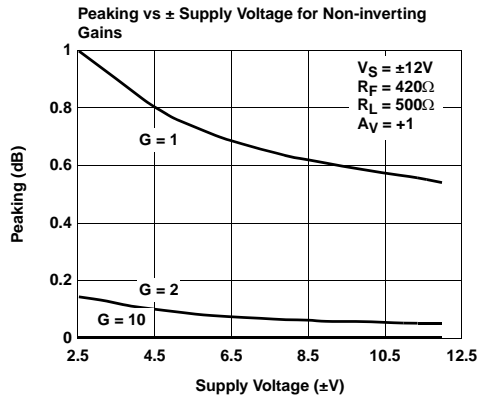
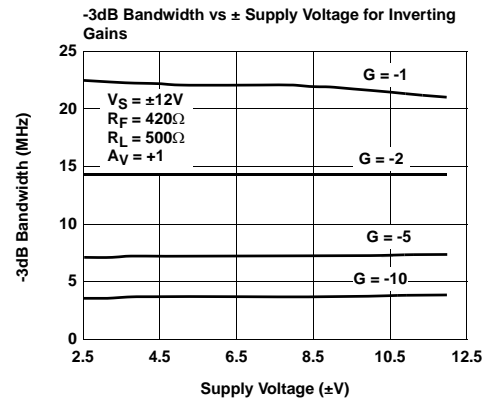
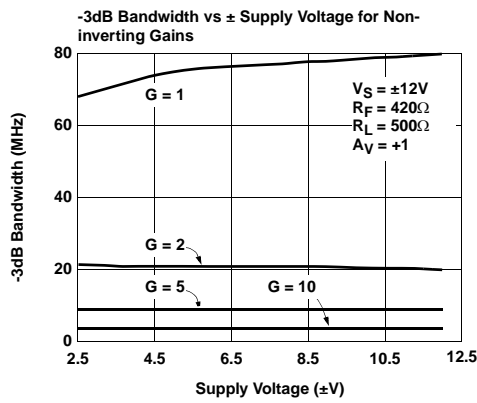
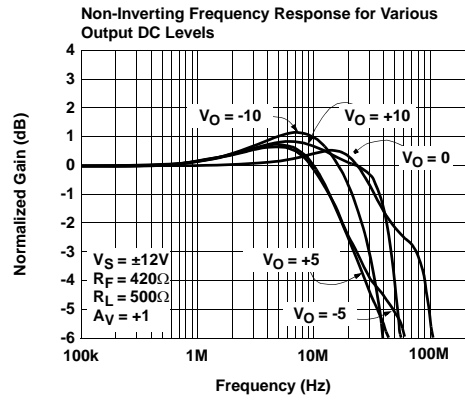
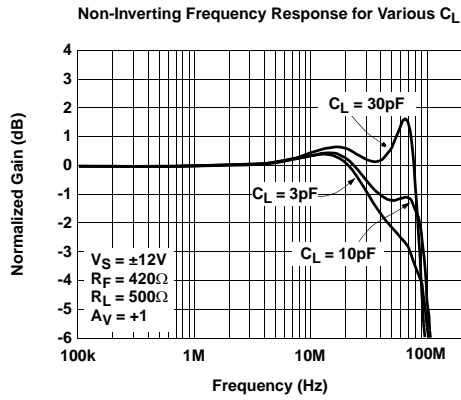

Typical Performance Curves (Continued)

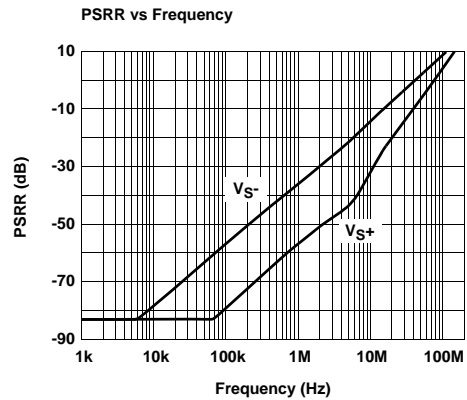
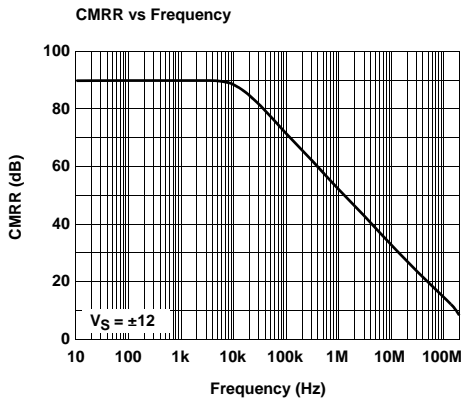
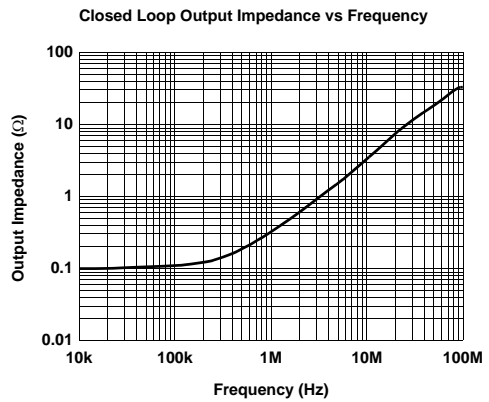
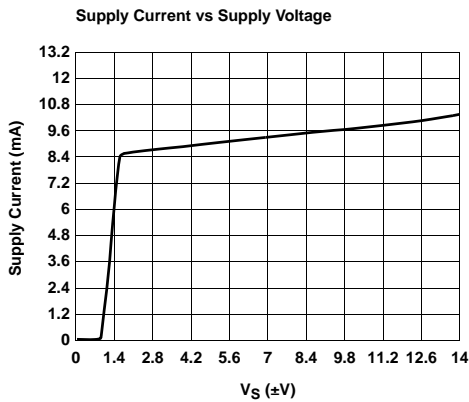
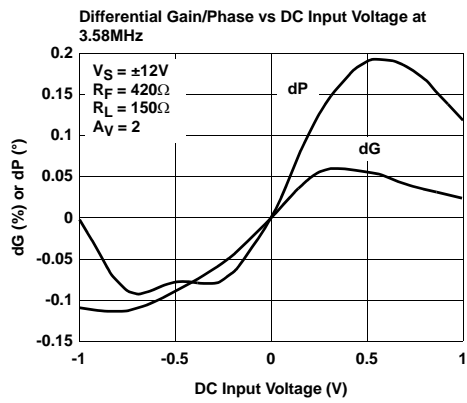
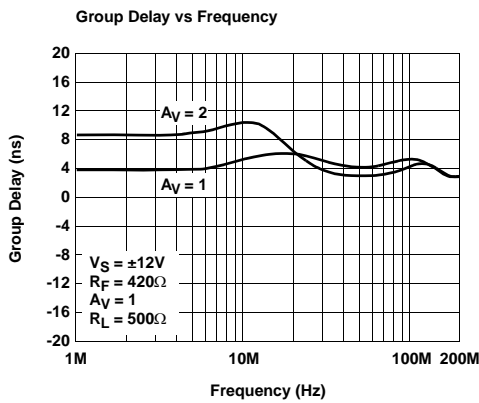
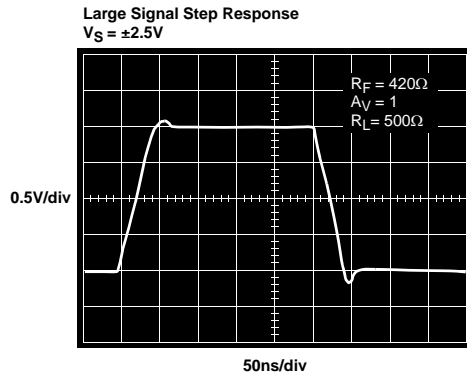
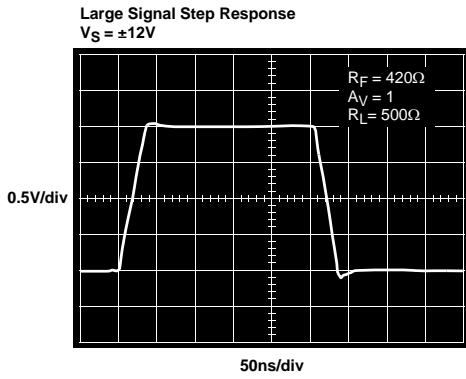

Typical Performance Curves (Continued)

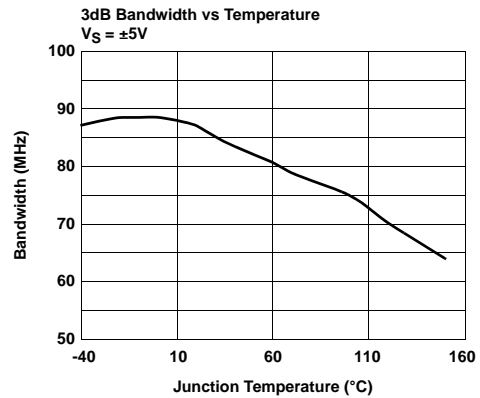
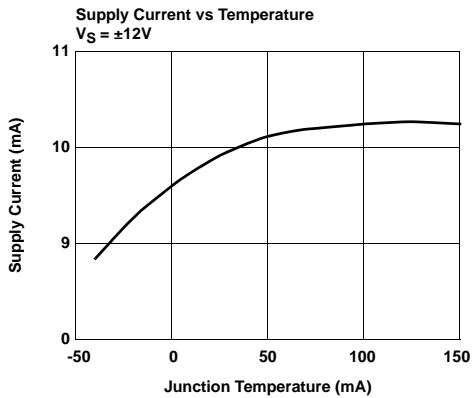
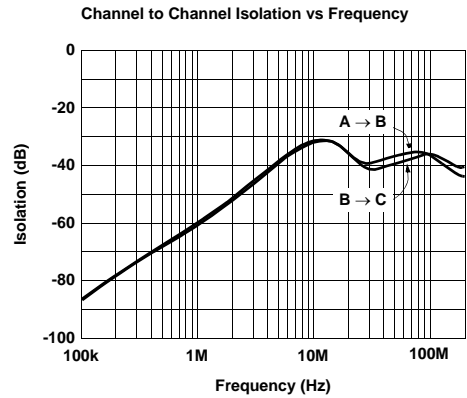
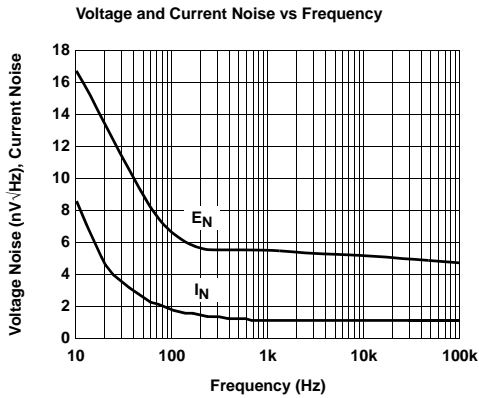
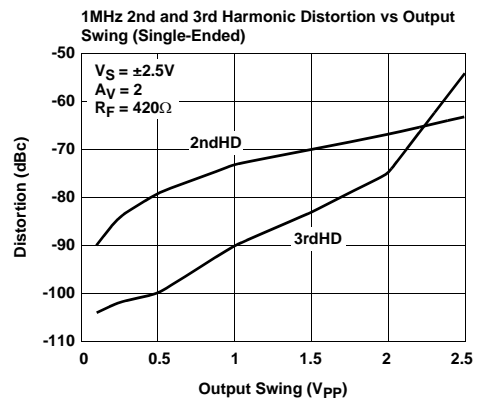
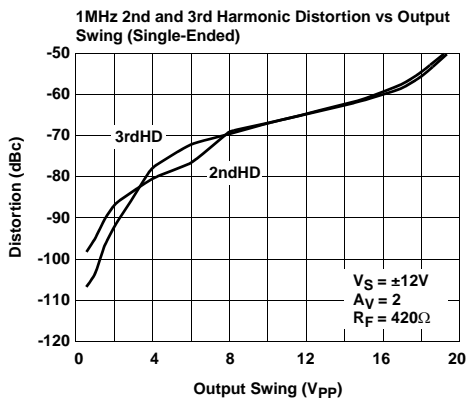
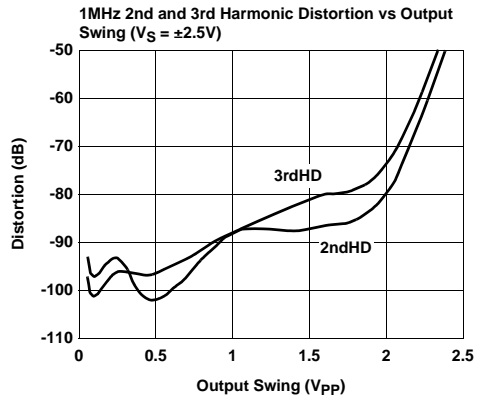
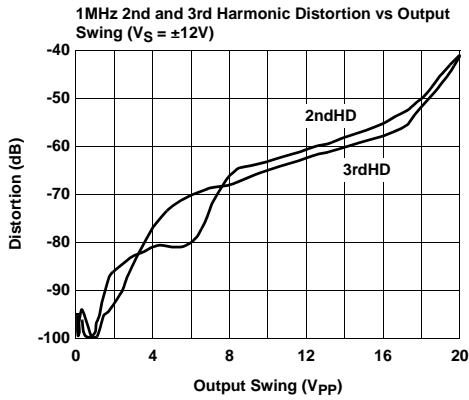

Typical Performance Curves (Continued)

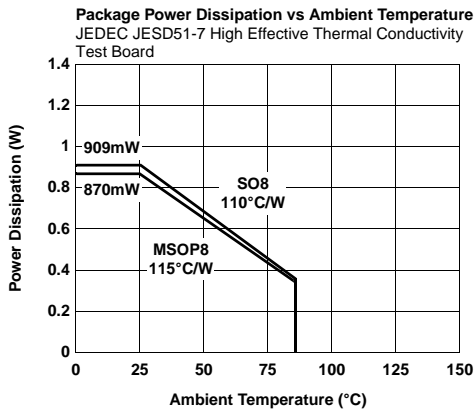
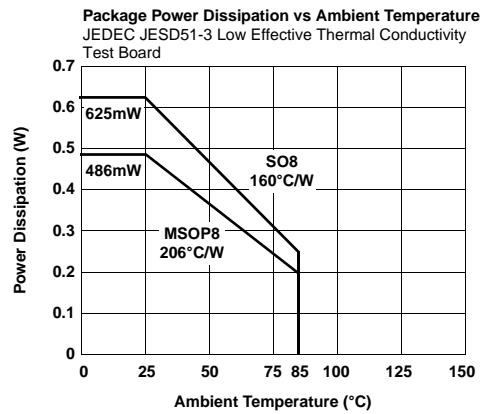
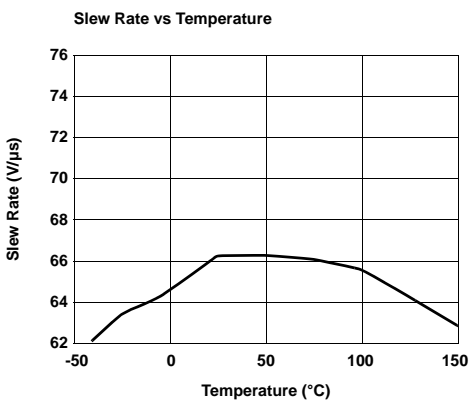
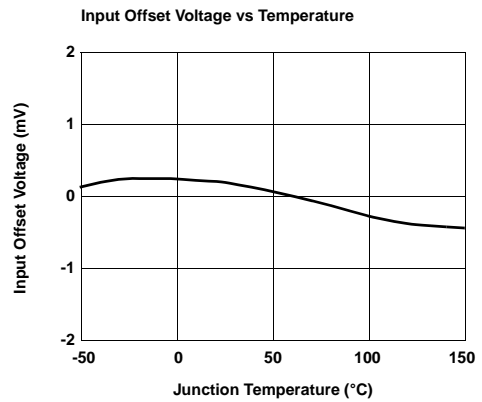
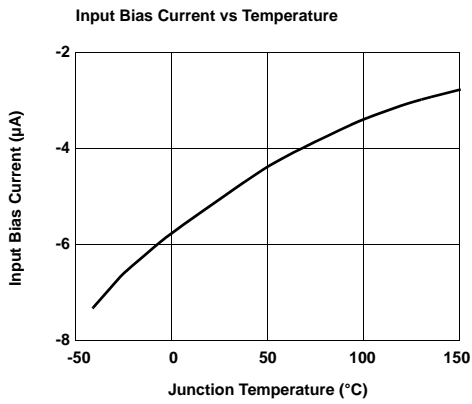

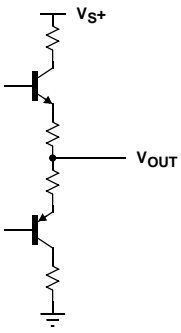
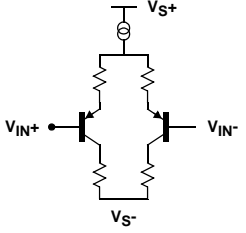

## Pin Descriptions

8-PIN MSOP	8-PIN SO	PIN NAME	PIN FUNCTION	EQUIVALENT CIRCUIT
1	1	$V_{OUTA}$	Output	 <p style="text-align: center;"><b>CIRCUIT 1</b></p>
2	2	$V_{INA-}$	Input	 <p style="text-align: center;"><b>CIRCUIT 2</b></p>
3	3	$V_{INA+}$	Input	Reference Circuit 2
4	4	$V_{S-}$	Supply	
5	5	$V_{INB+}$	Input	
6	6	$V_{INB-}$	Input	Reference Circuit 2
7	7	$V_{OUTB}$	Output	Reference Circuit 1
8	8	$V_{S+}$	Supply	

## Applications Information

### Product Description

The EL2228 is a dual voltage feedback operational amplifier designed especially for DMT ADSL and other applications requiring very low voltage and current noise. It also features low distortion while drawing moderately low supply current and is built on Elantec's proprietary high-speed complementary bipolar process. The EL2228 uses a classical voltage-feedback topology which allows them to be used in a variety of applications where current-feedback amplifiers are not appropriate because of restrictions placed upon the feedback element used with the amplifier. The conventional topology of the EL2228 allows, for example, a capacitor to be placed in the feedback path, making it an excellent choice for applications such as active filters, sample-and-holds, or integrators.

### Single-Supply Operation

The EL2228 was designed to have a wide input and output voltage range. This design also makes the EL2228 an

excellent choice for single-supply operation. Using a single positive supply, the lower input voltage range is within 300mV of ground ( $R_L = 500\Omega$ ), and the lower output voltage range is within 875mV of ground. Upper input voltage range reaches 3.6V, and output voltage range reaches 3.8V with a 5V supply and  $R_L = 500\Omega$ . This results in a 2.625V output swing on a single 5V supply. This wide output voltage range also allows single-supply operation with a supply voltage as high as 28V.

### Gain-Bandwidth Product and the -3dB Bandwidth

The EL2228 has a gain-bandwidth product of 40MHz while using only 5mA of supply current per amplifier. For gains greater than 1, their closed-loop -3dB bandwidth is approximately equal to the gain-bandwidth product divided by the noise gain of the circuit. For gains of 1, higher-order poles in the amplifiers' transfer function contribute to even higher closed loop bandwidths. For example, the EL2228 have a -3dB bandwidth of 80MHz at a gain of 1, dropping to 9MHz at a gain of 5. It is important to note that the EL2228 is designed so that this "extra" bandwidth in low-gain

application does not come at the expense of stability. As seen in the typical performance curves, the EL2228 in a gain of only 1 exhibited 0.5dB of peaking with a 500Ω load.

### Output Drive Capability

The EL2228 is designed to drive a low impedance load. It can easily drive 6V<sub>P-P</sub> signal into a 500Ω load. This high output drive capability makes the EL2228 an ideal choice for RF, IF, and video applications. Furthermore, the EL2228 is current-limited at the output, allowing it to withstand momentary short to ground. However, the power dissipation with output-shortened cannot exceed the power dissipation capability of the package.

### Driving Cables and Capacitive Loads

Although the EL2228 is designed to drive low impedance load, capacitive loads will decrease the amplifier's phase margin. As shown in the performance curves, capacitive load can result in peaking, overshoot and possible oscillation. For optimum AC performance, capacitive loads should be reduced as much as possible or isolated with a series resistor between 5Ω to 20Ω. When driving coaxial cables, double termination is always recommended for reflection-free performance. When properly terminated, the capacitance of the coaxial cable will not add to the capacitive load seen by the amplifier.

### Power Dissipation

With the wide power supply range and large output drive capability of the EL2228, it is possible to exceed the 150°C maximum junction temperatures under certain load and power-supply conditions. It is therefore important to calculate the maximum junction temperature (T<sub>JMAX</sub>) for all applications to determine if power supply voltages, load conditions, or package type need to be modified for the EL2228 to remain in the safe operating area. These parameters are related as follows:

$$T_{JMAX} = T_{MAX} + (\theta_{JA} \times PD_{MAXTOTAL})$$

where:

- PD<sub>MAXTOTAL</sub> is the sum of the maximum power dissipation of each amplifier in the package (PD<sub>MAX</sub>)
- PD<sub>MAX</sub> for each amplifier can be calculated as follows:

$$PD_{MAX} = 2 \times V_S \times I_{SMAX} + (V_S - V_{OUTMAX}) \times \frac{V_{OUTMAX}}{R_L}$$

where:

- T<sub>MAX</sub> = Maximum ambient temperature
- θ<sub>JA</sub> = Thermal resistance of the package
- PD<sub>MAX</sub> = Maximum power dissipation of 1 amplifier
- V<sub>S</sub> = Supply voltage
- I<sub>MAX</sub> = Maximum supply current of 1 amplifier
- V<sub>OUTMAX</sub> = Maximum output voltage swing of the application
- R<sub>L</sub> = Load resistance

### Power Supply Bypassing And Printed Circuit Board Layout

As with any high frequency devices, good printed circuit board layout is essential for optimum performance. Ground plane construction is highly recommended. Pin lengths should be kept as short as possible. The power supply pins must be closely bypassed to reduce the risk of oscillation. The combination of a 4.7μF tantalum capacitor in parallel with 0.1μF ceramic capacitor has been proven to work well when placed at each supply pin. For single supply operation, where pin 4 (V<sub>S-</sub>) is connected to the ground plane, a single 4.7μF tantalum capacitor in parallel with a 0.1μF ceramic capacitor across pin 8 (V<sub>S+</sub>).

For good AC performance, parasitic capacitance should be kept to a minimum. Ground plane construction again should be used. Small chip resistors are recommended to minimize series inductance. Use of sockets should be avoided since they add parasitic inductance and capacitance which will result in additional peaking and overshoot.

All Intersil U.S. products are manufactured, assembled and tested utilizing ISO9000 quality systems. Intersil Corporation's quality certifications can be viewed at [www.intersil.com/design/quality](http://www.intersil.com/design/quality)

*Intersil products are sold by description only. Intersil Corporation reserves the right to make changes in circuit design, software and/or specifications at any time without notice. Accordingly, the reader is cautioned to verify that data sheets are current before placing orders. Information furnished by Intersil is believed to be accurate and reliable. However, no responsibility is assumed by Intersil or its subsidiaries for its use; nor for any infringements of patents or other rights of third parties which may result from its use. No license is granted by implication or otherwise under any patent or patent rights of Intersil or its subsidiaries.*

For information regarding Intersil Corporation and its products, see [www.intersil.com](http://www.intersil.com)