



# Technical Data Sheet

## 3.0mm Round Type LED Lamps

### 1254-10UYD/S530-A3

#### ■ Features :

- Choice of various viewing angles
- Available on tape and reel.
- Reliable and robust
- Pb free
- The product itself will remain within RoHS compliant version.



#### ■ Descriptions :

- The series is specially designed for applications requiring higher brightness
- The led lamps are available with different colors, intensities.

#### ■ Applications :

- TV set
- Monitor
- Telephone
- Computer

PART NO.	Material	Emitted Color	Lens Color
1254-10UYD/S530-A3	AlGaInP	Super Yellow	Yellow Diffused



Technical Data Sheet  
3.0mm Round Type LED Lamps

1254-10UYD/S530-A3

Package Dimensions

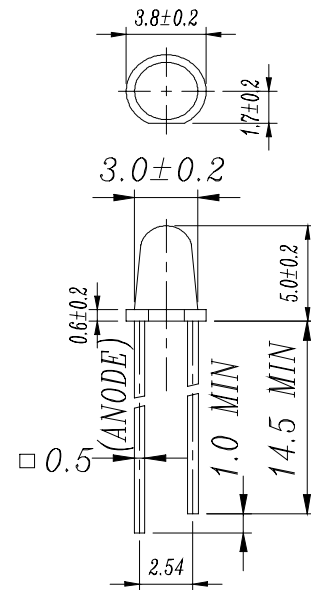

- Notes: 1. All dimensions are in millimetres  
2. The height of flange must be less than 1.5mm(0.059").  
3. Without special declared, the tolerance is  $\pm 0.25$ mm.

Absolute Maximum Ratings at  $T_a = 25^\circ\text{C}$

Parameter	Symbol	Rating	Unit
Forward Current	$I_F$	25	mA
Operating Temperature	$T_{opr}$	-40 to +85	$^\circ\text{C}$
Storage Temperature	$T_{stg}$	-40 to +100	$^\circ\text{C}$
Electrostatic Discharge	ESD	2000	V
Soldering Temperature	$T_{sol}$	$260 \pm 5$	$^\circ\text{C}$
Power Dissipation	$P_d$	60	mW
Reverse Voltage	$V_R$	5	V

Note: \*1: Soldering time  $\leq 5$  seconds.



Technical Data Sheet  
3.0mm Round Type LED Lamps

1254-10UYD/S530-A3

Electro-Optical Characteristics (Ta=25°C)

Parameter	Symbol	Condition	Min.	Typ.	Max.	Unit
Forward Voltage	V <sub>F</sub>	I <sub>F</sub> = 20 mA	/	2.0	2.4	V
Reverse Current	I <sub>R</sub>	V <sub>R</sub> = 5 V	/	/	10	μA
Luminous Intensity	I <sub>v</sub>	I <sub>F</sub> = 20 mA	100	200	/	mcd
Viewing Angle	2θ 1/2	I <sub>F</sub> = 20 mA	/	30	/	deg
Peak Wavelength	λ <sub>p</sub>	I <sub>F</sub> = 20 mA	/	591	/	nm
Dominant Wavelength	λ <sub>d</sub>	I <sub>F</sub> = 20 mA	/	589	/	nm
Spectrum Radiation Bandwidth	Δλ	I <sub>F</sub> = 20 mA	/	15	/	nm



# Technical Data Sheet

## 3.0mm Round Type LED Lamps

1254-10UYD/S530-A3

### Typical Electro-Optical Characteristic Curves:

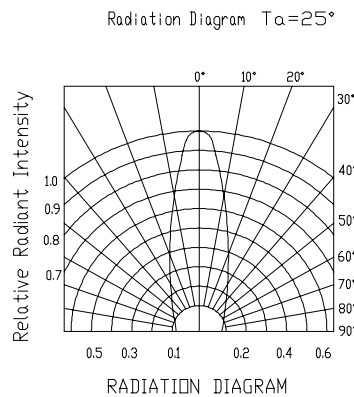
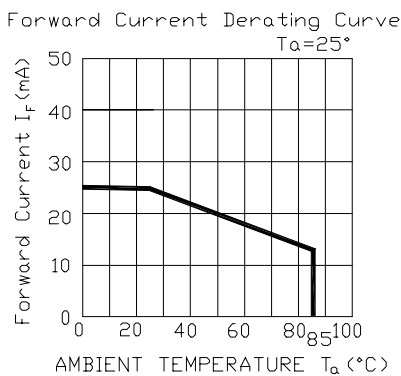
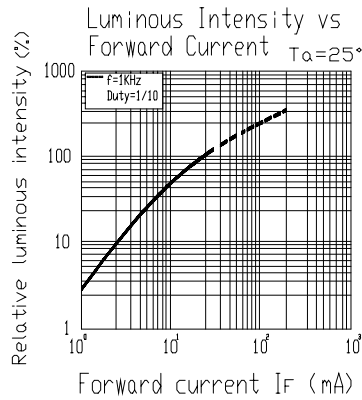
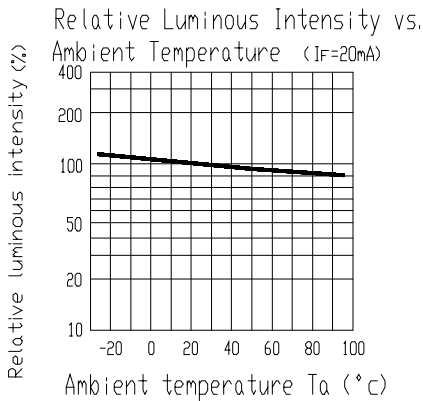
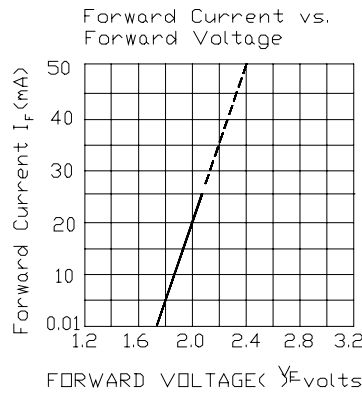
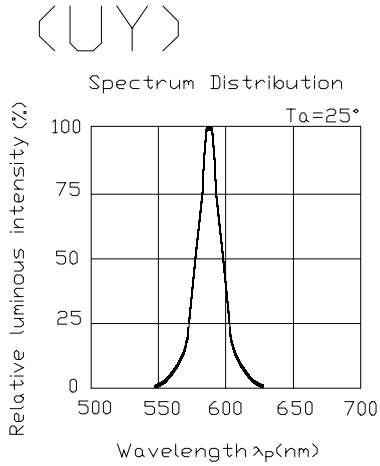



# Technical Data Sheet

## 3.0mm Round Type LED Lamps

1254-10UYD/S530-A3

### Reliability test items and conditions:

The reliability of products shall be satisfied with items listed below.

Confidence level : 97%

LTPD : 3%

NO	Item	Test Conditions	Test Hours/Cycle	Sample Size	Failure Judgment Criteria	Ac/Re
1	Solder Heat	TEMP : 260°C ± 5 °C	10 SEC	76 PCS	$I_v \leq I_{vt} * 0.5$ or $V_f \geq U$ or $V_f \leq L$	0/1
2	Temperature Cycle	H : +100°C 15min $\int$ 5 min L : -40°C 15min	300 CYCLES	76 PCS		0/1
3	Thermal Shock	H : +100°C 5min $\int$ 10 sec L : -10°C 5min	300 CYCLES	76 PCS		0/1
4	High Temperature Storage	TEMP : 100°C	1000 HRS	76 PCS		0/1
5	Low Temperature Storage	TEMP : -40°C	1000 HRS	76 PCS		0/1
6	DC Operating Life	TEMP : 25°C $I_F = 20mA$	1000 HRS	76 PCS		0/1
7	High Temperature / High Humidity	85°C / 85% RH	1000 HRS	76 PCS		0/1

Note :  $I_{vt}$  : To test  $I_v$  value of the chip before the reliability test  
 $I_v$  : The test value of the chip that has completed the reliability test  
U : Upper Specification Limit  
L : Lower Specification Limit



# Technical Data Sheet

## 3.0mm Round Type LED Lamps

1254-10UYD/S530-A3

### Packing Quantity Specification

1. 1000PCS/1Bag , 4Bags/1Box
2. 10Boxes/1Carton

### Label Form Specification

EVERLIGHT

CPN:  
P/N:



1254-10UYD/S530-A3

QTY: CAT:  
HUE: HUE:  
REF: REF:



LOT NO: EL



CPN: Customer's Production Number

P/N : Production Number

QTY: Packing Quantity

CAT: Ranks

HUE: Dominant Wavelength

REF: Reference

LOT No: Lot Number

### Notes

1. Above specification may be changed without notice. EVERLIGHT will reserve authority on material change for above specification.
2. When using this product, please observe the absolute maximum ratings and the instructions for using outlined in these specification sheets. EVERLIGHT assumes no responsibility for any damage resulting from use of the product which does not comply with the absolute maximum ratings and the instructions included in these specification sheets.
3. These specification sheets include materials protected under copyright of EVERLIGHT corporation. Please don't reproduce or cause anyone to reproduce them without EVERLIGHT's consent.

EVERLIGHT ELECTRONICS CO., LTD.

Office: No 25, Lane 76, Sec 3, Chung Yang Rd,  
Tucheng, Taipei 236, Taiwan, R.O.C

Tel: 886-2-2267-2000, 2267-9936

Fax: 886-2267-6244, 2267-6189, 2267-6306  
<http://www.everlight.com>