

Features

- Excellent capability of absorbing transient surge
- Quick response to surge voltage (nS Level)
- Eliminates overvoltage caused by fast rising transients
- Moisture sensitivity level: level 1
- Weight 88 mg
- Non degenerative
- Bi-directional

Exterior



SMB-T

Application information

- POE

Package (top view)



Agency Approvals

Icon	Description
RoHS	Compliance with 2011/65/EU
HF	Compliance with IEC61249-2-21:2003

Schematic Symbol

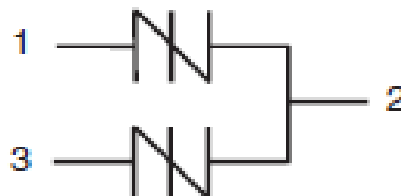

Part Number and Electrical Parameter

Part Number	IDRM@VDRM		Vs ^① @ Is		VT@ IT		IH	Co ^②
	μA	V	V	mA	V	A	mA	pF
	MAX	Pin1,3-2	Pin1,3-2		MAX		MIN	MAX
BS0640N-2C	5	58	77	800	4	2.2	150	100

Absolute maximum ratings measured at TA= 25°C RH = 45%-75% (unless otherwise noted).

①Vs is measured at 100KV/S

② Off-state Capacitance is measured at VDC=2V, VRMS=1V,f=1MHz

Part Numbering System

Mark

BS 0640 N 2 C
(1) (2) (3) (4) (5)

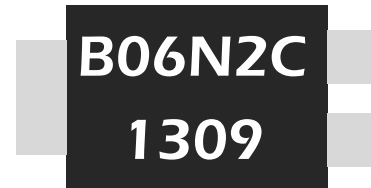

B06N2C: Part Number
1309 :Septempter,2013

- (1)Bencent Semiconductor Surge Arrester
- (2)Off state Voltage,e.g:0640=64×10⁰=64V.
- (3) Package : SMB-T
- (4) 2 Lines Protection
- (5) Rating Surge Voltage: 6KV (10/700μS)

V-I Curve

Parameters	Definition
V _{DRM}	Peak Off-state Voltage
I _{DRM}	Off-state Current
V _S	Switching Voltage
I _S	Switching Current
I _H	Holding Current
V _T	On-state Voltage
I _T	On-state Current
C _O	Off-state Capacitance

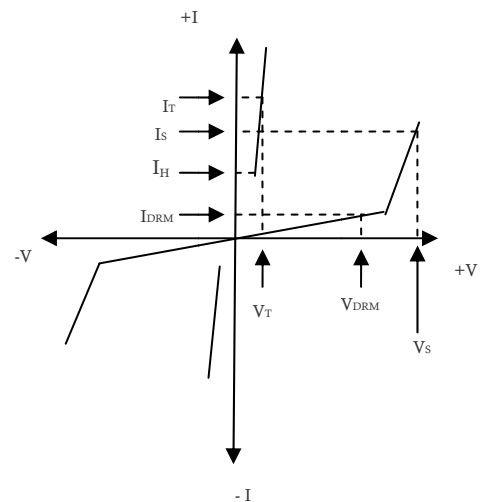

Surge Ratings

Current Waveform	2/10μs	8/20μs	10/160μs	5/320μs*	10/1000μs
Voltage Waveform	2/10μs	1.2/50μs	10/160μs	10/700μs*	10/1000μs
I _{pp}	500A	400A	200A	150A	100A

-Peak pulse current rating (I_{pp})is repetitive and guaranteed for the life of the product;

-Bencent only makes the test for 5/320μs@150A*(10/700μs@6KV),but for other IPP valuederived from experience isjust for reference only. Bencent will not take any obligation for these parameters, so before applyingour parts, please make sure to verify theparameters listed in the above table.

Thermal Considerations

Symbol	Parameter	Value	Unit
T _J	Operating Junction Temperature Range	-40 to +150	°C
T _S	Storage Temperature Range	-60 to +150	°C

Physical Characteristics

Lead Material	Copper Alloy
Body Material	UL recognized epoxy meeting flammability classification 94V-0
Terminal Finish	100% Matte-Tin Plated

Typical Characteristics

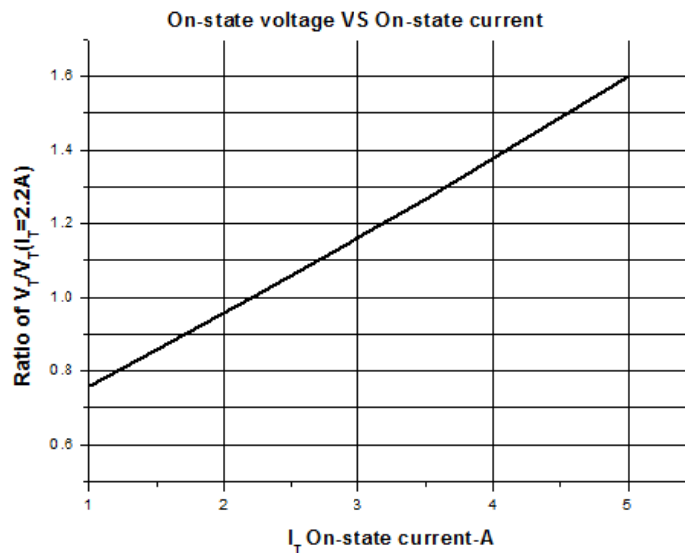
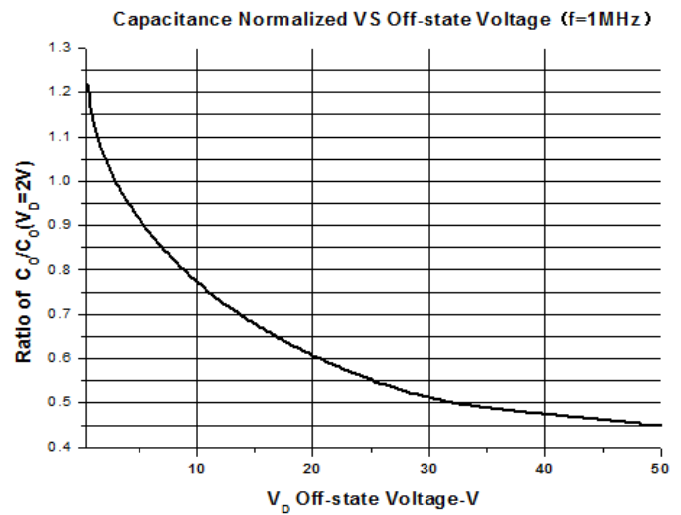
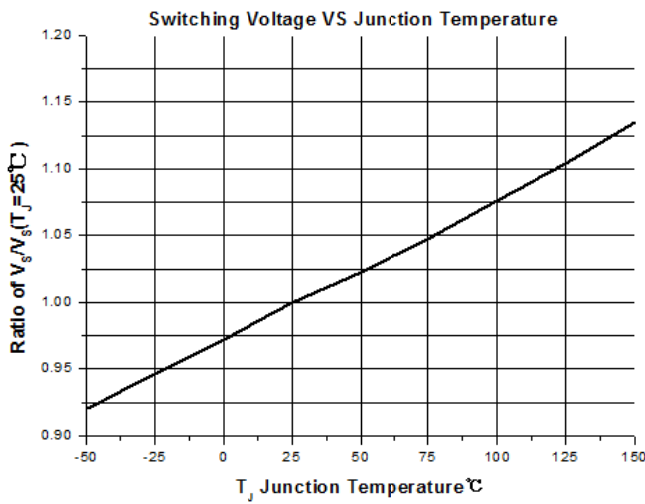
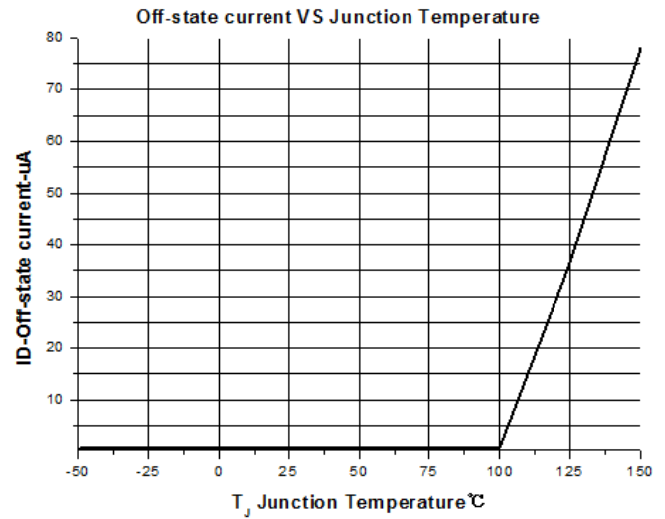
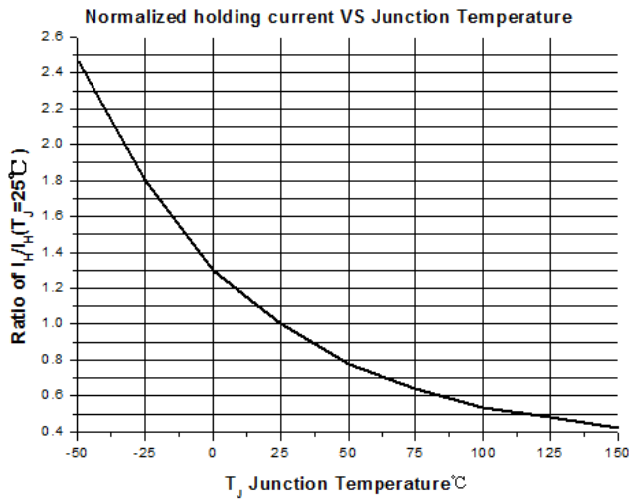

Environmental Characteristics

Testing Items	Technical Standards
High Temperature Reverse Bias Test	Temperature: $150\pm 3^{\circ}\text{C}$, Bias= $80\%V_{\text{DRM}}$ Time:168H
High Temperature Life Test	Temperature: 150°C Time:168H
High-low Temperature Cycle Test	Temperature:From -40°C to 125°C Dwell time: 30min, 10-100 cycles
High Temperature &High Humidity Test	Temperature: 85°C Humidity:85% Test time:168H
Pressure Cooker Test	Temperature: 121°C , 2atm. Humidity:100% Test time: 24H to 168H
Resistance of Soldering Heat	Temperature: $260\pm 5^{\circ}\text{C}$ Time of dip soldering: 10s, 3times

Note: The above testing items can be specified by customers by contacting Bencent service

Product Dimensions

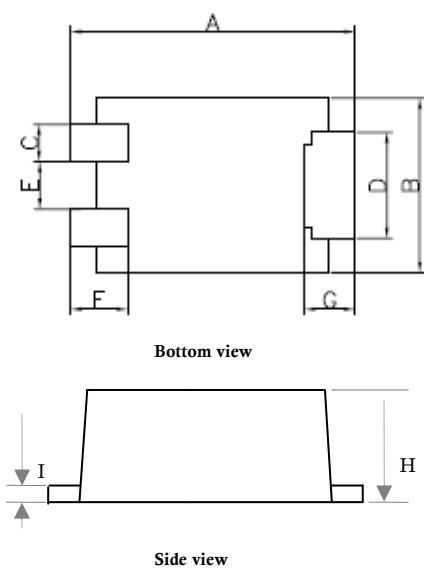

REF	mm	inch
A	5.4 ± 0.3	0.213 ± 0.012
B	3.3 ± 0.3	0.130 ± 0.012
C	0.7 ± 0.03	0.028 ± 0.001
D	2.0 ± 0.2	0.079 ± 0.008
E	0.9 ± 0.2	0.035 ± 0.008
F	1.32 ± 0.3	0.052 ± 0.012
G	1.13 ± 0.3	0.045 ± 0.012
H	2 ± 0.3	0.079 ± 0.012
I	0.25 ± 0.05	0.010 ± 0.002

Recommended Soldering Pad

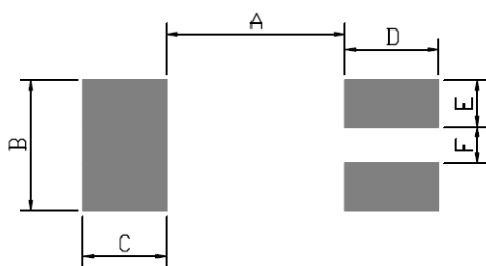

REF	mm	inch
A	3.4	0.134
B	2.5	0.098
C	1.6	0.059
D	1.8	0.059
E	0.9	0.035
F	0.7	0.032

Reflow Profile

Reflow Condition		Pb-Free Assembly
Pre Heat	Temperature Min.	+150°C
	Temperature Max.	+200°C
	Time(Min to Max)	60 – 180 secs.
Average ramp up rate(LiquidusTemp(T_L) to peak)		3°C/sec. Max.
Ts(max) to T_L - Ramp-up Rate		3°C/sec. Max.
Reflow	- Temperature (T_L) (Liquidus)	+217°C
	- Temperature (T_L)	60 – 150 secs.
Peak Temp (T_P)		+(260+0/-5)°C
Time within 5°C of actual Peak Temp (T_P)		8 – 15 secs.
Ramp-down Rate		6°C/sec. Max.
Time 25°C to peak Temp (T_P)		8 min. Max.
Do not exceed		+260°C

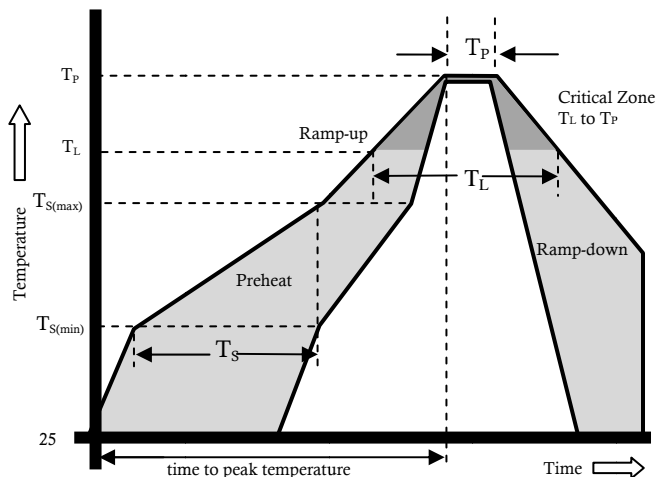

Package Reel Information

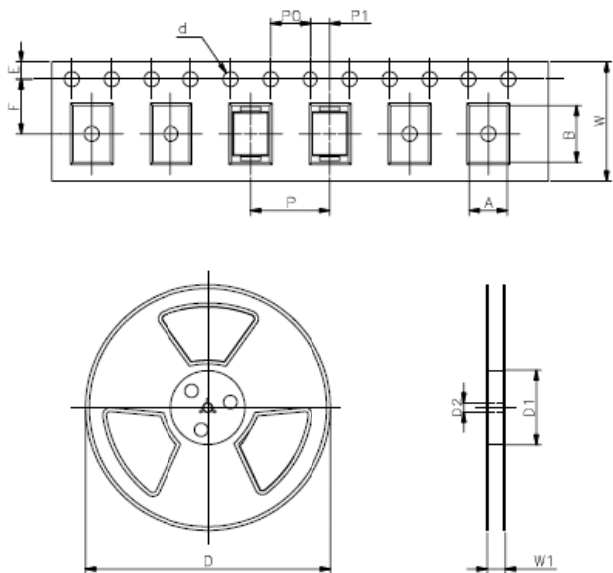

REF	mm	inch
A	3.65+/-0.3	0.144+/-0.012
B	5.69+/-0.3	0.244+/-0.012
d	1.5+/-0.1	0.059+/-0.004
D	330.0	13.0
D1	100+/-3	3.937+/-0.118
D2	13+/-0.3	0.512+/-0.012
E	1.5+/-0.2	0.059+/-0.008
F	5.65+/-0.2	0.222+/-0.008
P	8.0+/-0.2	0.315+/-0.008
P0	4.0+/-0.2	0.157+/-0.008
P1	2.0+/-0.2	0.079+/-0.008
W	12.0+/-0.2	0.472+/-0.008
W1	16.8+/-2.0	0.661+/-0.079

Outline	Reel (pcs)	Per Carton (pcs)	Reel Diameters (mm)	Carton Size(mm)		
				L	W	H
Taping	3,000	24,000	330	360	360	380