

# RC3005 THRU RC310

## SINGLE-PHASE SILICON BRIDGE RECTIFIER

VOLTAGE: 50-1000V

CURRENT: 3.0A

### FEATURES

- Surge overload ratings-90 Amperes
- Good for printed circuit board assembly

### MECHANICAL DATA

- **Case:** Silicon rubber passivated
- **Epoxy:** UL 94V-0 rate flame retardant
- **Lead:** MIL-STD- 202E, Method 208 guaranteed
- **Polarity:** As marked
- **Mounting position:** Any
- **Weight:** 1.88 grams

### C-1

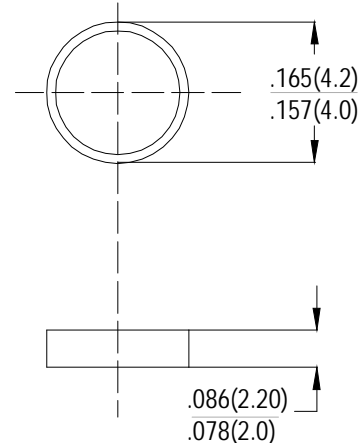

Dimensions in inches and (millimeters)

## MAXIMUM RATINGS AND ELECTRICAL CHARACTERISTICS

Ratings at 25°C ambient temperature unless otherwise specified.

Single phase, half wave, 60Hz, resistive or inductive load.

For capacitive load, derate current by 20%.

	SYMBOL	RC3005	RC301	RC302	RC304	RC306	RC308	RC310	units
Maximum Recurrent Peak Reverse Voltage	$V_{RRM}$	50	100	200	400	600	800	1000	V
Maximum RMS Bridge Input Voltage	$V_{RMS}$	35	70	140	280	420	560	700	V
Maximum DC Blocking Voltage	$V_{DC}$	50	100	200	400	600	800	1000	V
Maximum Average Forward rectified Output Current at $T_A=50^\circ\text{C}$	$I_o$	3.0							A
Peak Forward Surge Current 8.3ms single half sine-wave superimposed on rate load (JEDEC method)	$I_{FSM}$	90							A
Maximum Forward Voltage Drop per element at 3.0A DC	$V_F$	1.0							V
Maximum DC Reverse Current at Rated DC Blocking Voltage per element	@ $T_A=25^\circ\text{C}$	5.0							$\mu\text{A}$
	@ $T_A=100^\circ\text{C}$	500							
$I^2t$ Rating for Fusing ( $t < 8.3\text{ms}$ )	$I^2t$	10							$\text{A}^2\text{S}$
Typical Junction Capacitance (Note 1)	$C_J$	25							pF
Typical Thermal Resistance (Note 2)	$R_{\theta JA}$	40							$^\circ\text{C/W}$

Notes: 1. Measured at 1MHz and applied reverse voltage of 4.0 volts

2. Thermal Resistance from Junction to lead mounted on P.C.B with 0.47×0.47" (12×12mm) copper pads