



BTW67 and BTW69 Series

STANDARD

50A SCRs

Table 1: Main Features

| Symbol | Value | Unit |
|-------------------|-------------|------|
| $I_{T(RMS)}$ | 50 | A |
| V_{DRM}/V_{RRM} | 600 to 1200 | V |
| I_{GT} | 80 | mA |

DESCRIPTION

Available in high power packages, the **BTW67 / BTW69** Series is suitable in applications where power handling and power dissipation are critical, such as solid state relays, welding equipment, high power motor control.

Based on a clip assembly technology, they offer a superior performance in surge current handling capabilities.

Thanks to their internal ceramic pad, they provide high voltage insulation (2500V_{RMS}), complying with UL standards (file ref: E81734).

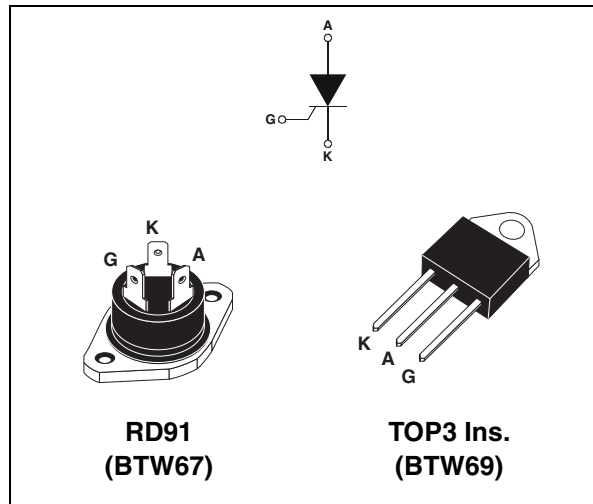

Table 2: Order Codes

| Part Numbers | Marking |
|--------------|----------|
| BTW67-xxx | BTW67xxx |
| BTW69-xxxRG | BTW69xxx |

Table 3: Absolute Ratings (limiting values)

| Symbol | Parameter | Value | Unit | |
|--------------------|---|--|--------------------------------|------------------|
| $I_{T(RMS)}$ | RMS on-state current (180° conduction angle) | RD91 $T_c = 70^\circ C$ | 50 | A |
| | | TOP3 Ins. $T_c = 75^\circ C$ | | |
| $I_{T(AV)}$ | Average on-state current (180° conduction angle) | RD91 $T_c = 70^\circ C$ | 32 | A |
| | | TOP3 Ins. $T_c = 75^\circ C$ | | |
| I_{TSM} | Non repetitive surge peak on-state current | $t_p = 8.3 \text{ ms}$ $T_j = 25^\circ C$ | 610 | A |
| | | $t_p = 10 \text{ ms}$ $T_j = 25^\circ C$ | 580 | |
| I^2t | I^2t Value for fusing | $T_j = 25^\circ C$ | 1680 | A ² s |
| di/dt | Critical rate of rise of on-state current $I_G = 2 \times I_{GT}$, $t_r \leq 100 \text{ ns}$ | F = 60 Hz $T_j = 125^\circ C$ | 50 | A/ μ s |
| I_{GM} | Peak gate current | $t_p = 20 \mu\text{s}$ $T_j = 125^\circ C$ | 8 | A |
| $P_{G(AV)}$ | Average gate power dissipation | $T_j = 125^\circ C$ | 1 | W |
| T_{stg} T_j | Storage junction temperature range Operating junction temperature range | | - 40 to + 150 - 40 to + 125 | $^\circ C$ |
| V_{RGM} | Maximum peak reverse gate voltage | | 5 | V |

BTW67 and BTW69 Series

Tables 4: Electrical Characteristics ($T_j = 25^\circ\text{C}$, unless otherwise specified)

| Symbol | Test Conditions | | Value | Unit | | |
|------------------------|---|-----------------------------|---------------------------|------|------|------------------|
| I_{GT} | $V_D = 12\text{ V}$ | $R_L = 33\ \Omega$ | MIN. | 8 | mA | |
| | | | MAX. | 80 | | |
| V_{GT} | | | MAX. | 1.3 | V | |
| V_{GD} | $V_D = V_{DRM}$ | $R_L = 3.3\ \text{k}\Omega$ | $T_j = 125^\circ\text{C}$ | MIN. | 0.2 | V |
| I_H | $I_T = 500\ \text{mA}$ Gate open | | | MAX. | 150 | mA |
| I_L | $I_G = 1.2 \times I_{GT}$ | | | MAX. | 200 | mA |
| dV/dt | $V_D = 67\% V_{DRM}$ Gate open | | $T_j = 125^\circ\text{C}$ | MIN. | 1000 | V/ μs |
| V_{TM} | $I_{TM} = 100\ \text{A}$ $t_p = 380\ \mu\text{s}$ | | $T_j = 25^\circ\text{C}$ | MAX. | 1.9 | V |
| V_{T0} | Threshold voltage | | $T_j = 125^\circ\text{C}$ | MAX. | 1.0 | V |
| R_d | Dynamic resistance | | $T_j = 125^\circ\text{C}$ | MAX. | 8.5 | m Ω |
| I_{DRM} I_{RRM} | $V_{DRM} = V_{RRM}$ | | $T_j = 25^\circ\text{C}$ | MAX. | 10 | μA |
| | | | $T_j = 125^\circ\text{C}$ | | 5 | mA |

Table 5: Thermal resistance

| Symbol | Parameter | | Value | Unit |
|---------------|----------------------------|------------------|-------|--------------------|
| $R_{th(j-c)}$ | Junction to case (D.C.) | RD91 (Insulated) | 1.0 | $^\circ\text{C/W}$ |
| | | TOP3 Insulated | 0.9 | |
| $R_{th(j-a)}$ | Junction to ambient (D.C.) | TOP3 Insulated | 50 | $^\circ\text{C/W}$ |

Figure 1: Maximum average power dissipation versus average on-state current

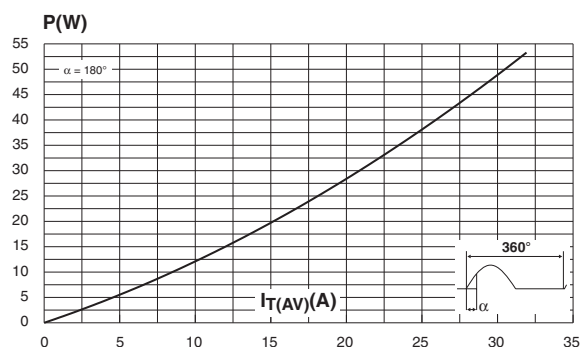

Figure 2: Average and D.C. on-state current versus case temperature

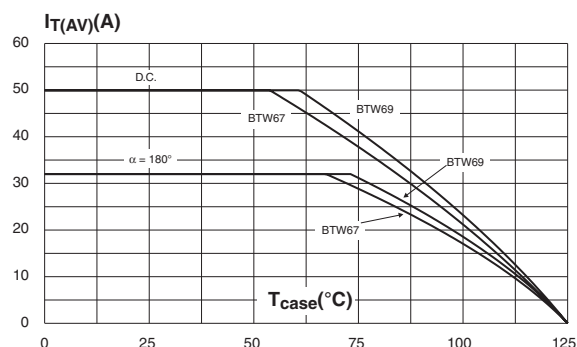

Figure 3: Relative variation of thermal impedance versus pulse duration

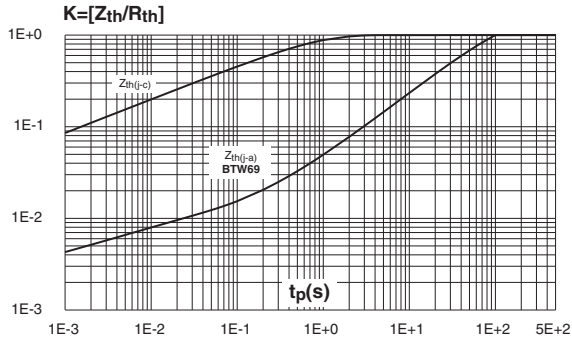

Figure 4: Relative variation of gate trigger current, holding current and latching current versus junction temperature

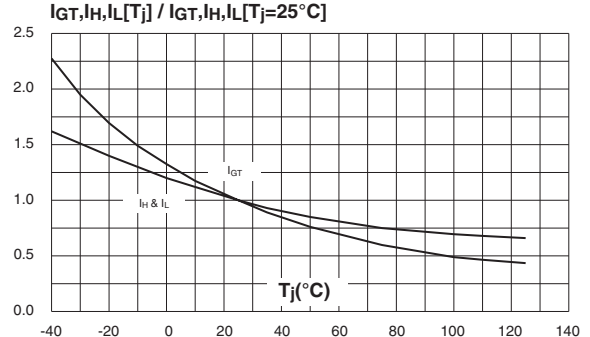

Figure 5: Surge peak on-state current versus number of cycles

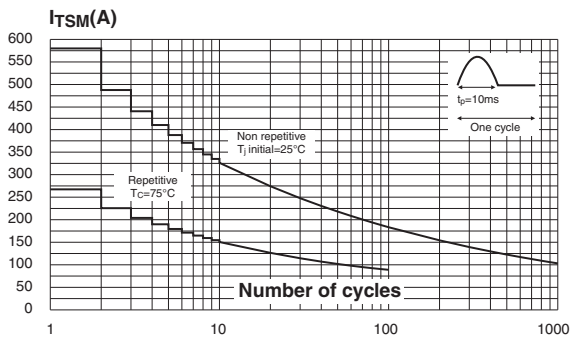

Figure 6: Non-repetitive surge peak on-state current for a sinusoidal pulse with width tp < 10 ms, and corresponding values of I²t

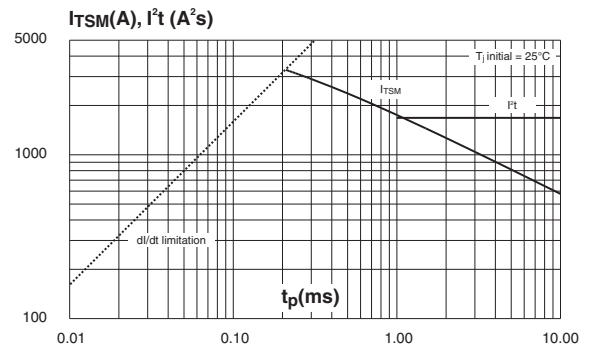
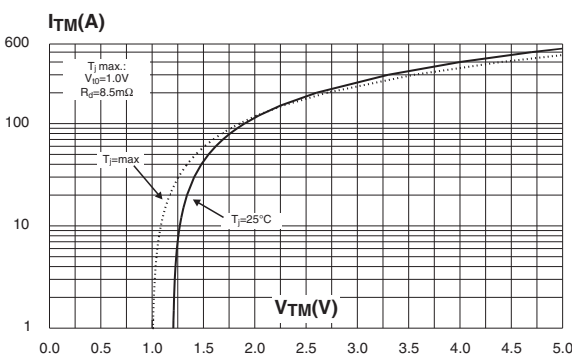

Figure 7: On-state characteristics (maximum values)



BTW67 and BTW69 Series

Figure 8: Ordering Information Scheme

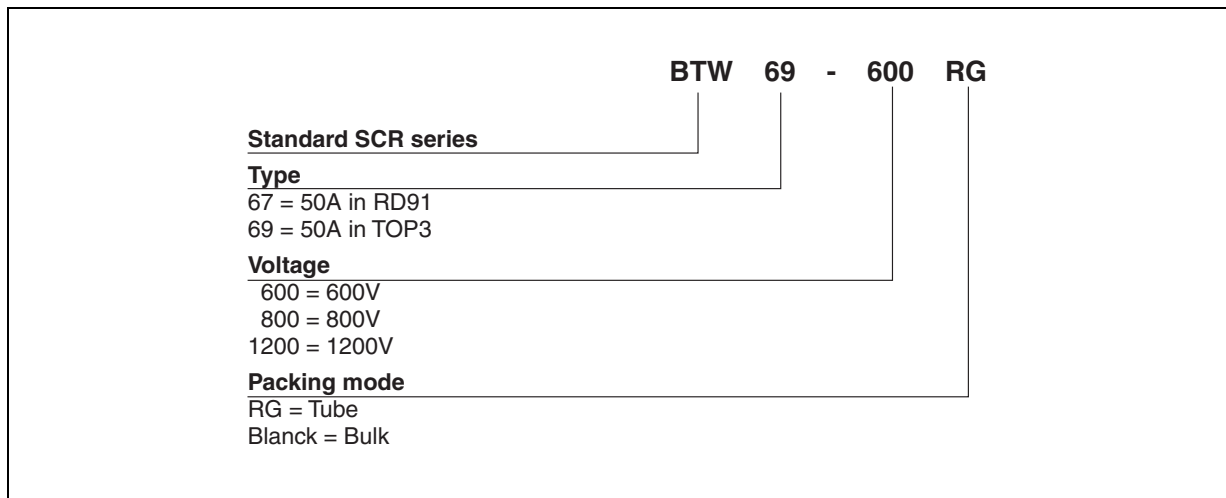

Table 6: Product Selector

| Part Numbers | Voltage (xxx) | | | Sensitivity | Package |
|--------------|---------------|-------|--------|-------------|-----------|
| | 600 V | 800 V | 1200 V | | |
| BTW67-xxx | X | X | X | 80 mA | RD91 |
| BTW69-xxx | X | X | X | 80 mA | TOP3 Ins. |

Figure 9: RD91 Package Mechanical Data

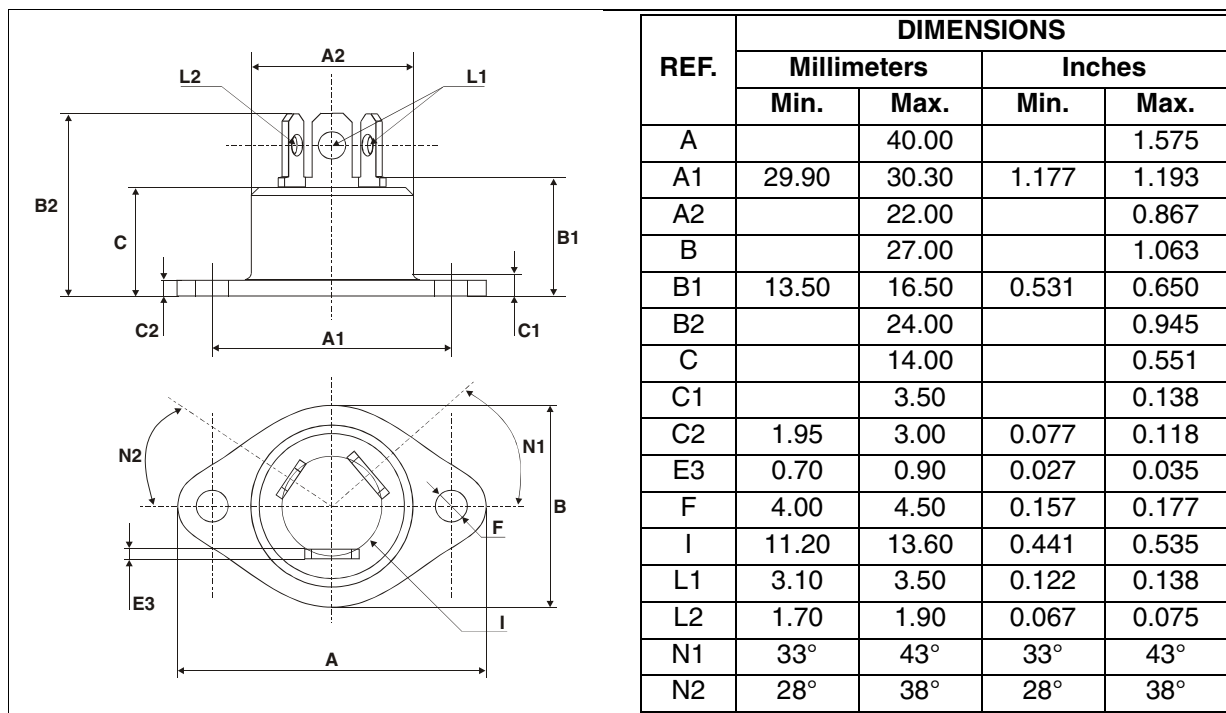
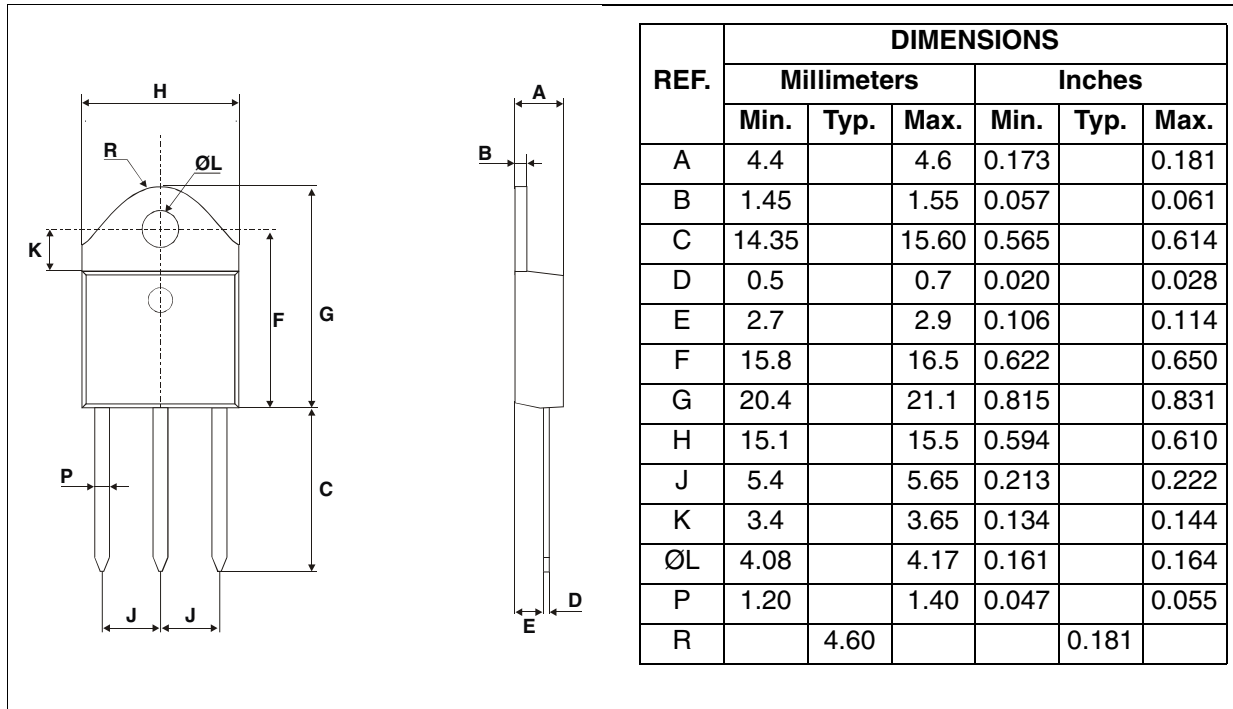

Figure 10: TOP3 Insulated Package Mechanical Data



In order to meet environmental requirements, ST offers these devices in ECOPACK® packages. These packages have a Lead-free second level interconnect. The category of second level interconnect is marked on the package and on the inner box label, in compliance with JEDEC Standard JESD97. The maximum ratings related to soldering conditions are also marked on the inner box label. ECOPACK is an ST trademark. ECOPACK specifications are available at: www.st.com.

Table 7: Ordering Information

| Ordering type | Marking | Package | Weight | Base qty | Delivery mode |
|---------------|----------|-----------|--------|----------|---------------|
| BTW67-xxx | BTW67xxx | RD91 | 20 g | 25 | Bulk |
| BTW69-xxxRG | BTW69xxx | TOP3 Ins. | 4.5 g | 30 | Tube |

Note: xxx = voltage

Table 8: Revision History

| Date | Revision | Description of Changes |
|-------------|----------|--|
| Apr-2001 | 4A | Last update. |
| 13-Feb-2006 | 5 | TOP3 Insulated delivery mode changed from bulk to tube. ECOPACK statement added. |

Information furnished is believed to be accurate and reliable. However, STMicroelectronics assumes no responsibility for the consequences of use of such information nor for any infringement of patents or other rights of third parties which may result from its use. No license is granted by implication or otherwise under any patent or patent rights of STMicroelectronics. Specifications mentioned in this publication are subject to change without notice. This publication supersedes and replaces all information previously supplied. STMicroelectronics products are not authorized for use as critical components in life support devices or systems without express written approval of STMicroelectronics.

The ST logo is a registered trademark of STMicroelectronics.
All other names are the property of their respective owners

© 2006 STMicroelectronics - All rights reserved

STMicroelectronics group of companies

Australia - Belgium - Brazil - Canada - China - Czech Republic - Finland - France - Germany - Hong Kong - India - Israel - Italy - Japan -
Malaysia - Malta - Morocco - Singapore - Spain - Sweden - Switzerland - United Kingdom - United States of America
www.st.com