



2SD468

NPN SILICON TRANSISTOR

LOW FREQUENCY POWER AMPLIFIER

■ FEATURES

- * Low frequency power amplifier
- * Complement to 2SB562

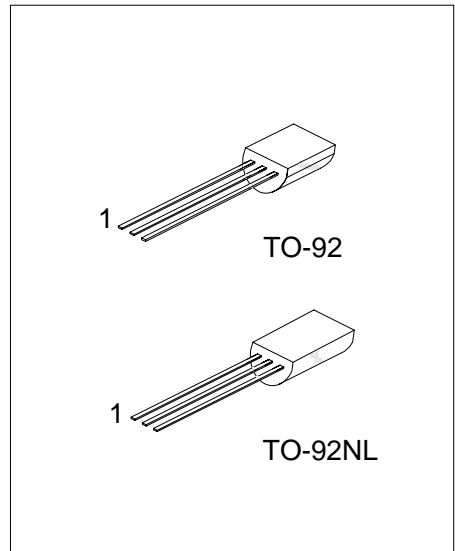

*Pb-free plating product number: 2SD468L

■ ORDERING INFORMATION

Ordering Number		Package	Pin Assignment			Packing
Normal	Lead Free Plating		1	2	3	
2SD468-x-T92-B	2SD468L-x-T92-B	TO-92	E	C	B	Tape Box
2SD468-x-T92-K	2SD468L-x-T92-K	TO-92	E	C	B	Bulk
2SD468-x-T9N-B	2SD468L-x-T9N-B	TO-92NL	E	C	B	Tape Box
2SD468-x-T9N-K	2SD468L-x-T9N-K	TO-92NL	E	C	B	Bulk

<p>2SD468L-x-T92-B</p> <p>(1)Packing Type (2)Package Type (3)Rank (4)Lead Plating</p>	<p>(1) B: Tape Box, K: Bulk (2) T92: TO-92, T9N: TO-92NL (3) x: refer to Classification of h_{FE} (4) L: Lead Free Plating, Blank: Pb/Sn</p>
---	---

■ ABSOLUTE MAXIMUM RATINGS (Ta=25 , unless otherwise specified)

PARAMETER	SYMBOL	RATINGS	UNIT
Collector-Base Voltage	V_{CBO}	25	V
Collector-Emitter Voltage	V_{CEO}	20	V
Emitter-Base Voltage	V_{EBO}	5	V
Collector Current	I_C	1	A
Collector Peak Current	I_{CP}	1.5	A
Collector Power Dissipation	P_C	0.9	W
Junction Temperature	T_J	+150	
Storage Temperature	T_{STG}	-55 ~ +150	

Note: Absolute maximum ratings are those values beyond which the device could be permanently damaged. Absolute maximum ratings are stress ratings only and functional device operation is not implied.

■ ELECTRICAL CHARACTERISTICS (Ta=25 , unless otherwise specified)

PARAMETER	SYMBOL	TEST CONDITIONS	MIN	TYP	MAX	UNIT
Collector-Base Breakdown Voltage	BV_{CBO}	$I_C=10\mu A, I_E=0$	25			V
Collector-Emitter Breakdown Voltage	BV_{CEO}	$I_C=1mA, R_{BE}=\infty$	20			V
Emitter-Base Breakdown Voltage	BV_{EBO}	$I_E=10\mu A, I_C=0$	5			V
Collector Cut-Off Current	I_{CBO}	$V_{CB}=20V, I_E=0$			1	μA
DC Current Transfer Ratio	h_{FE}	$V_{CE}=2V, I_C=0.5A$ (Note)	85		240	
Collector-Emitter Saturation Voltage	$V_{CE(SAT)}$	$I_C=0.8A, I_B=0.08A$ (Note)		0.2	0.5	V
Base-Emitter Voltage	V_{BE}	$V_{CE}=2V, I_C=0.5A$ (Note)		0.79	1	V
Gain Bandwidth Product	f_T	$V_{CE}=2V, I_C=0.5A$ (Note)		190		MHz
Collector Output Capacitance	C_{ob}	$V_{CB}=10V, I_E=0, f=1MHz$		22		pF

Note: Pulse test

■ CLASSIFICATION OF h_{FE}

RANK	B	C
RANGE	85 - 170	120 - 240

■ TYPICAL CHARACTERISTICS

Maximum Collector Dissipation Curve

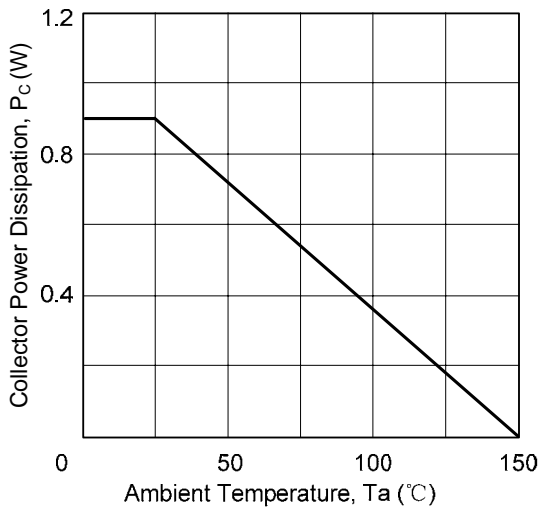

Typical Output Characteristics

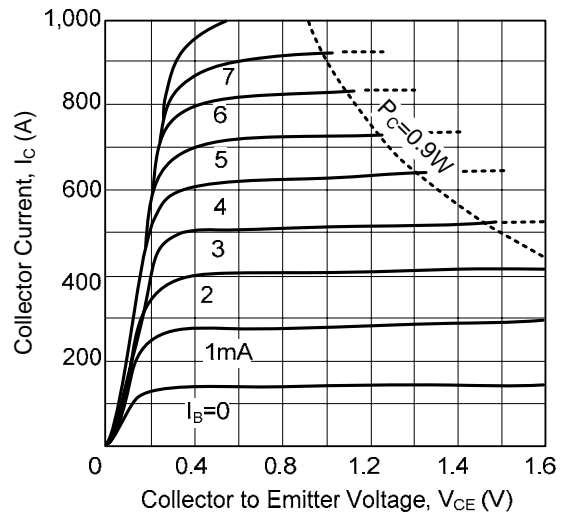

Typical Transfer Characteristics

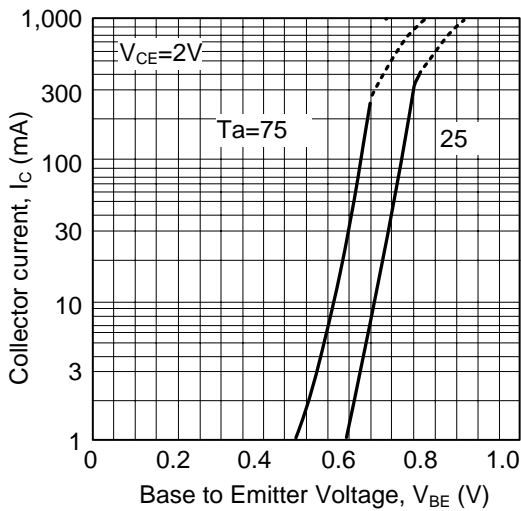

DC Current Transfer Ratio vs. Collector Current

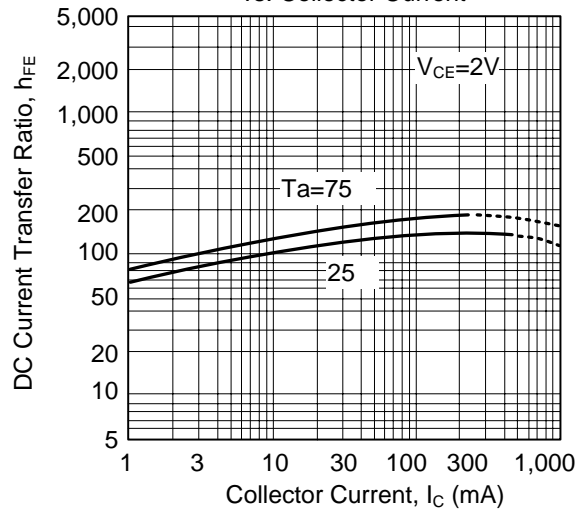

Collector to Emitter Saturation Voltage vs. Collector Current

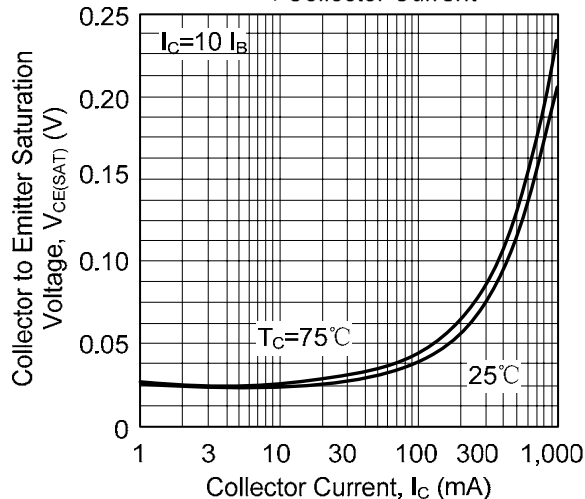

Gain Bandwidth Product vs. Collector Current

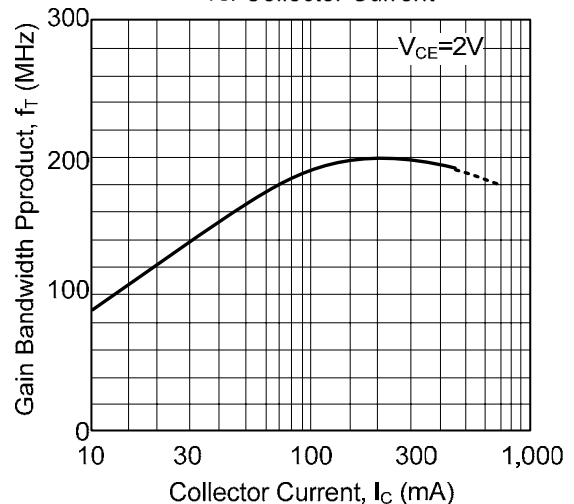

■ TYPICAL CHARACTERISTICS(Cont.)

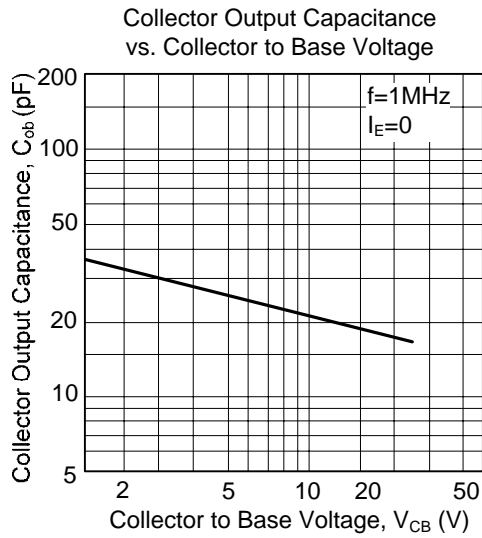

UTC assumes no responsibility for equipment failures that result from using products at values that exceed, even momentarily, rated values (such as maximum ratings, operating condition ranges, or other parameters) listed in products specifications of any and all UTC products described or contained herein. UTC products are not designed for use in life support appliances, devices or systems where malfunction of these products can be reasonably expected to result in personal injury. Reproduction in whole or in part is prohibited without the prior written consent of the copyright owner. The information presented in this document does not form part of any quotation or contract, is believed to be accurate and reliable and may be changed without notice.