

Features

- Attenuation: 1 dB Steps to 50 dB
- Low DC Power Consumption
- Small Footprint, JEDEC Package
- Integral TTL Driver
- 50 ohm Impedance
- Test Boards are Available
- Tape and Reel Packaging Available
- Lead-Free CSP-1 Package
- 100% Matte Tin Plating over Copper
- Halogen-Free “Green” Mold Compound
- 260°C Reflow Compatible
- RoHS* Compliant Version of AT90-0106

Description

M/A-COM's MAAD-007082-000100 is a GaAs FET 6-bit digital attenuator with integral TTL driver. Step size is 1 dB providing a 50 dB total attenuation range. This device is in a PQFN plastic surface mount package. The MAAD-007082-000100 is ideally suited for use where accuracy, fast speed, very low power consumption and low costs are required.

Ordering Information

Part Number	Package
MAAD-007082-000100	Bulk Packaging
MAAD-007082-0001TR	1000 piece reel
MAAD-007082-0001TB	Sample Test Board

Note: Reference Application Note M513 for reel size information.

* Restrictions on Hazardous Substances, European Union Directive 2002/95/EC.

Functional Schematic

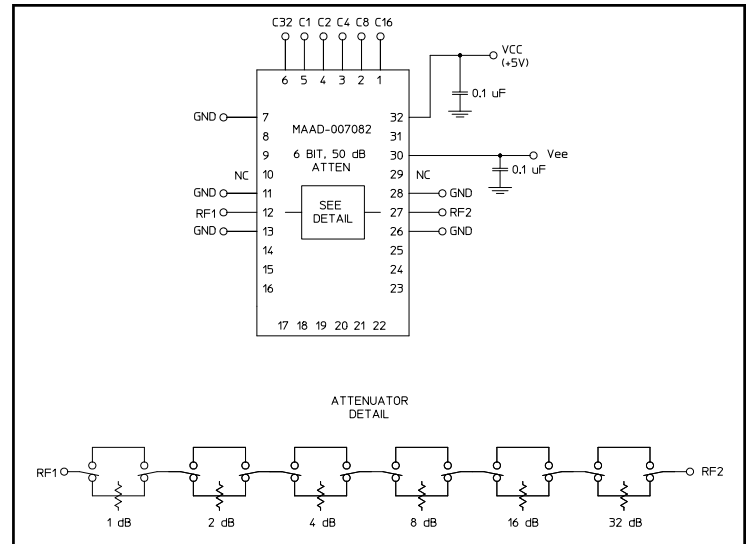

Pin Configuration¹

Pin No.	Function	Pin No.	Function
1	C16	17	NC
2	C8	18	NC
3	C4	19	NC
4	C2	20	NC
5	C1	21	NC
6	C32	22	NC
7	GND	23	NC
8	NC	24	NC
9	NC	25	NC
10	NC ²	26	GND
11	GND	27	RF2
12	RF1	28	GND
13	GND	29	NC ²
14	NC	30	-Vee
15	NC	31	NC
16	NC	32	+Vcc

1. The exposed pad centered on the package bottom must be connected to RF and DC ground. (For PQFN Packages)
2. Pins 10 and 29 must be isolated.

ADVANCED: Data Sheets contain information regarding a product M/A-COM Technology Solutions is considering for development. Performance is based on target specifications, simulated results, and/or prototype measurements. Commitment to develop is not guaranteed.
PRELIMINARY: Data Sheets contain information regarding a product M/A-COM Technology Solutions has under development. Performance is based on engineering tests. Specifications are typical. Mechanical outline has been fixed. Engineering samples and/or test data may be available. Commitment to produce in volume is not guaranteed.

• **North America** Tel: 800.366.2266 • **Europe** Tel: +353.21.244.6400
 • **India** Tel: +91.80.4155721 • **China** Tel: +86.21.2407.1588
 Visit www.macomtech.com for additional data sheets and product information.

M/A-COM Technology Solutions Inc. and its affiliates reserve the right to make changes to the product(s) or information contained herein without notice.

Electrical Specifications: $T_A = 25^\circ\text{C}$, $Z_0 = 50\Omega$

Parameter	Test Conditions	Frequency	Units	Min	Typ	Max
Insertion Loss	—	DC - 2.4 GHz	dB	—	5.5	6.0
Attenuation Accuracy	Individual Bits 1-2-4-8-16-32 dB Any Combination of Bits 1 to 50 dB	DC - 2.4 GHz DC - 2.4 GHz	dB dB	— —	— —	$\pm(.3 +5\%$ of atten setting) $\pm(.5 +8\%$ of atten setting)
VSWR	Full Range	DC - 2.4 GHz	Ratio	—	1.8:1	2:1
Switching Speed	50% Cntl to 90%/10% RF 10% to 90% or 90% to 10%	— —	ns ns	— —	75 20	150 50
1 dB Compression	— —	50 MHz 0.5 - 2.40 GHz	dBm dBm	— —	+21 +24	— —
Input IP_3	Two-tone inputs up to +5 dBm	50 MHz 0.5-2.4 GHz	dB dB	— —	+35 +48	— —
+Vcc -Vee	— —	— —	V V	4.75 -8.0	5.0 -5.0	5.25 -4.75
Logic "0"	Sink Current is 20 μA max.	—	V	0.0	—	0.8
Logic "1"	Source Current is 20 μA max.	—	V	2.0	—	5.0
V_{IL} V_{IH}	LOW-level input voltage HIGH-level input voltage	— —	V V	0.0 2.0	— —	0.8 5.0
I_{in} (Input Leakage Current)	$V_{in} = V_{CC}$ or GND	—	μA	-1.0	—	1.0
I_{cc} (Quiescent Supply Current)	$V_{cntrl} = V_{CC}$ or GND	—	μA	—	250	400
ΔI_{cc}^3 (Additional Supply Current Per TTL Input Pin)	$V_{CC} = \text{Max}$, $V_{cntrl} = V_{CC} - 2.1 \text{ V}$	—	mA	—	—	1.0
I_{EE}	V_{EE} min to max, $V_{in} = V_{IL}$ or V_{IH}	—	mA	-1.0	-0.2	—
Thermal Resistance θ_{jc}	—	—	$^\circ\text{C}/\text{W}$	—	15	—

Absolute Maximum Ratings ^{3,4}

Parameter	Absolute Maximum
Max. Input Power 0.05 GHz 0.5 - 2.4 GHz	+27 dBm +34 dBm
V_{CC}	$-0.5\text{V} \leq V_{CC} \leq +7.0\text{V}$
V_{EE}	$-8.5\text{V} \leq V_{EE} \leq +0.5\text{V}$
$V_{CC} - V_{EE}$	$-0.5\text{V} \leq V_{CC} - V_{EE} \leq 14.5\text{V}$
V_{in}^5	$-0.5\text{V} \leq V_{in} \leq V_{CC} + 0.5\text{V}$
Operating Temperature	-40°C to $+85^\circ\text{C}$
Storage Temperature	-65°C to $+125^\circ\text{C}$

- Exceeding any one or combination of these limits may cause permanent damage to this device.
- M/A-COM does not recommend sustained operation near these survivability limits.
- Standard CMOS TTL interface, latch-up will occur if logic signal is applied prior to power supply.

Truth Table

C32	C16	C8	C4	C2	C1	Attenuation
0	0	0	0	0	0	Loss, Reference
0	0	0	0	0	1	1.0 dB
0	0	0	0	1	0	2.0 dB
0	0	0	1	0	0	4.0 dB
0	0	1	0	0	0	8.0 dB
0	1	0	0	0	0	16.0 dB
1	0	0	0	0	0	32.0 dB
1	1	0	0	1	0	50.0 dB

0 = TTL Low; 1 = TTL High

Handling Procedures

Please observe the following precautions to avoid damage:

Static Sensitivity

Gallium Arsenide Integrated Circuits are sensitive to electrostatic discharge (ESD) and can be damaged by static electricity. Proper ESD control techniques should be used when handling these devices.

Moisture Sensitivity

The MSL rating for this part is defined as Level 2 per IPC/JEDEC J-STD-020. Parts shall be stored and/or baked as required for MSL Level 2 parts.

Recommended PCB Configuration⁶

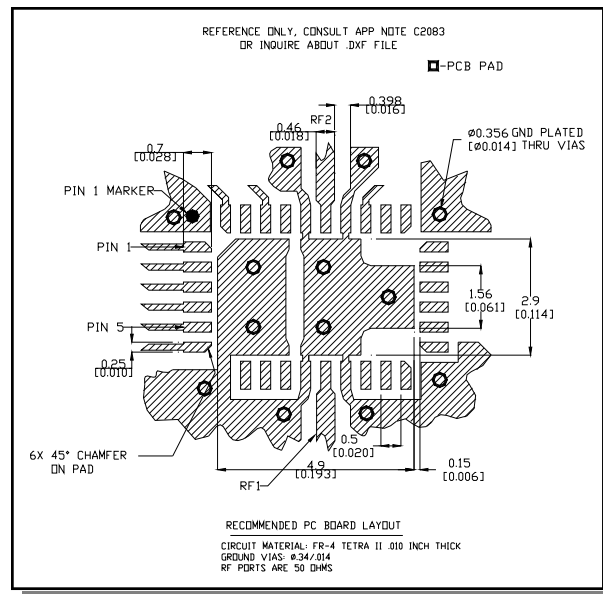

6. Application Note C2083 is available on line at www.macom.com

Typical Performance Curves

Insertion Loss

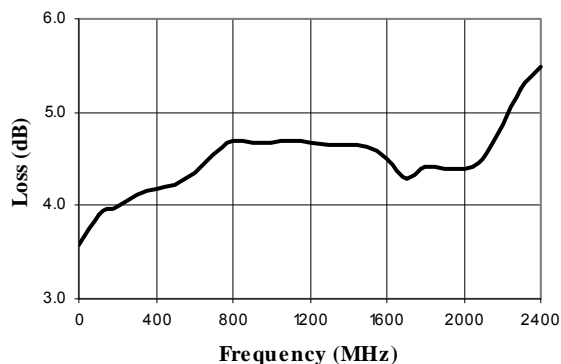

VSWR @ Insertion Loss

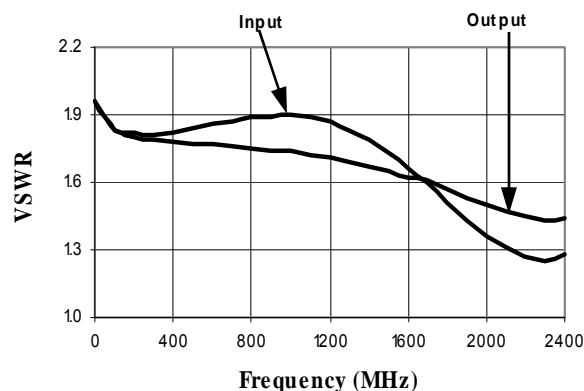

Typical Performance Curves

Attenuation Error, 1 dB Bit

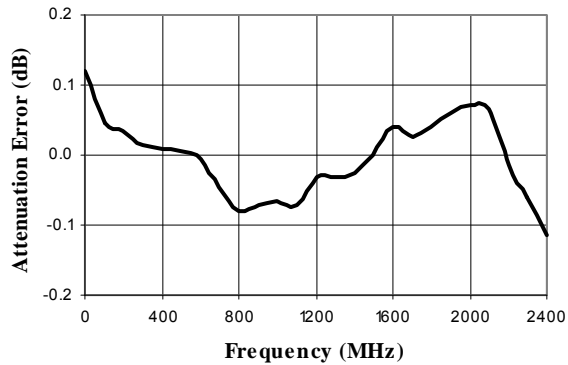

Attenuation Error, 2 dB Bit

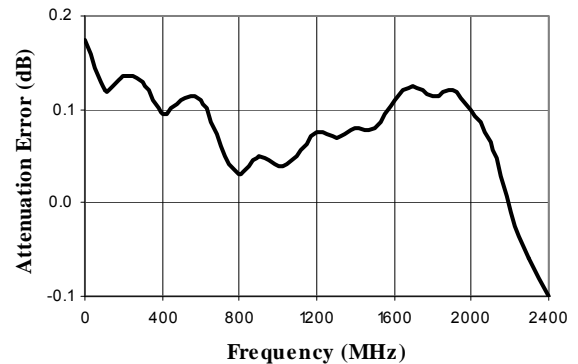

Attenuation Error, 4 dB Bit

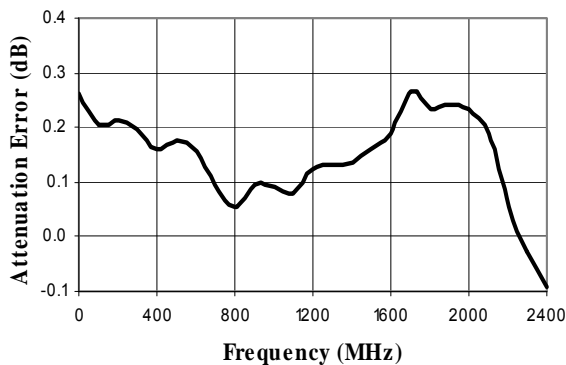

Attenuation Error, 8 dB Bit

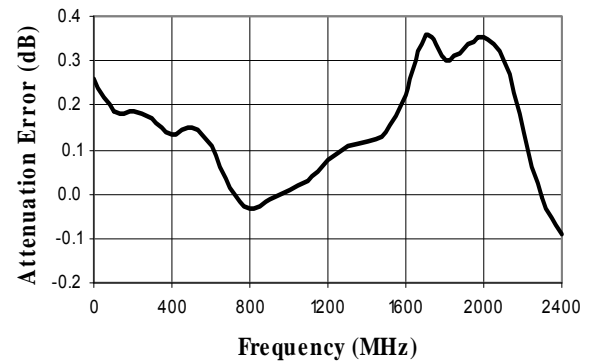

Attenuation Error, 16 dB Bit

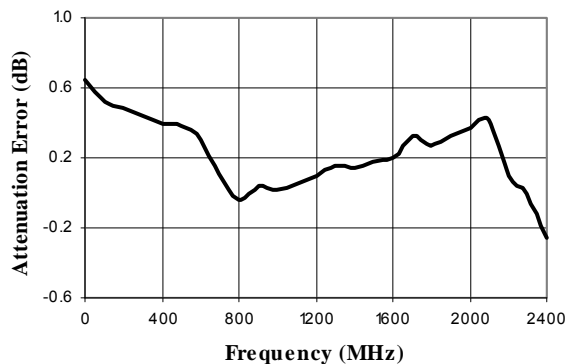

Attenuation Error, 32 dB Bit

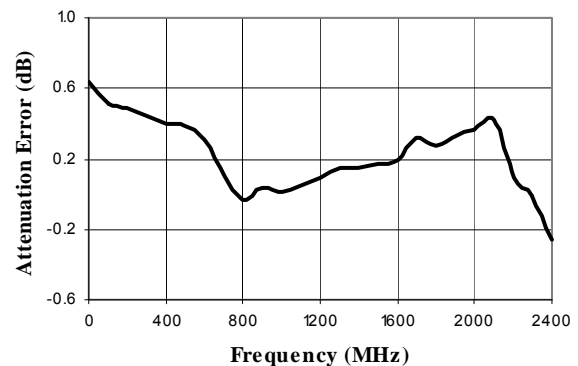

Typical Performance Curves

Attenuation Error, Max. Attenuation

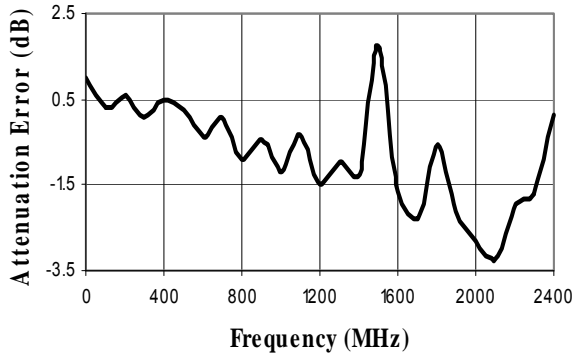

VSWR, 1 dB Bit

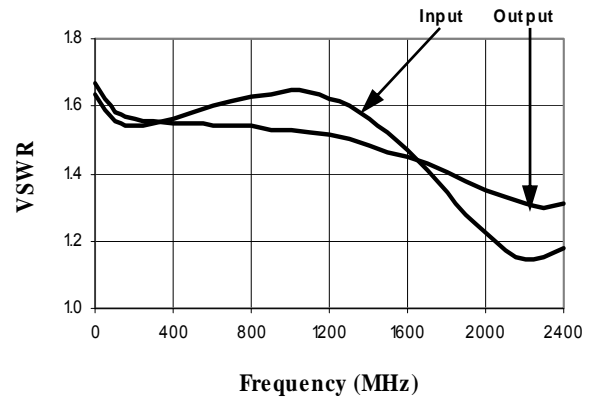

VSWR, 2 dB Bit

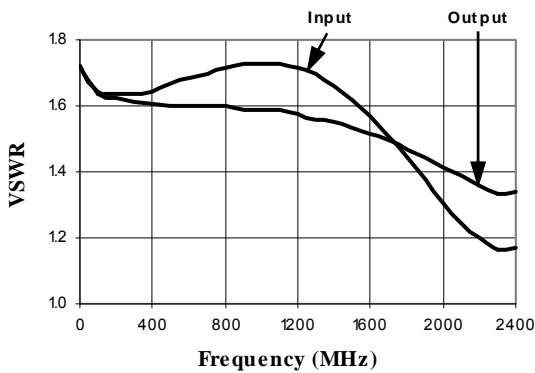

VSWR, 4 dB Bit

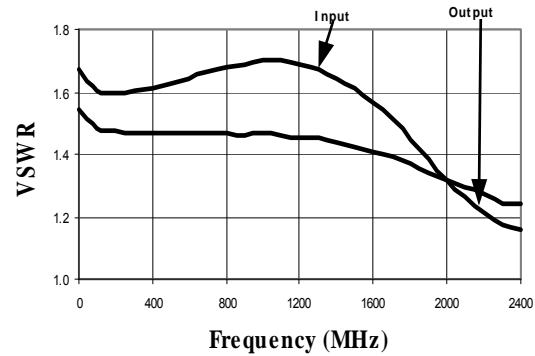

VSWR, 8 dB Bit

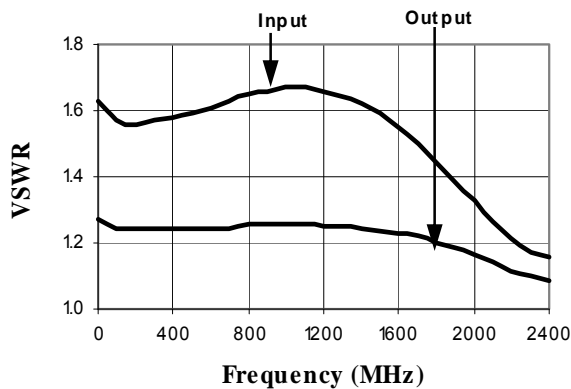

VSWR, 16 dB Bit

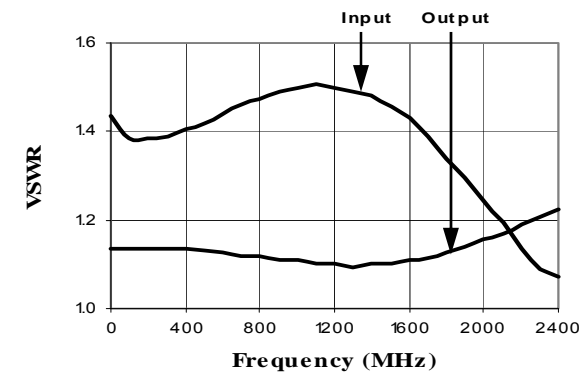

Typical Performance Curves

VSWR, 32 dB Bit

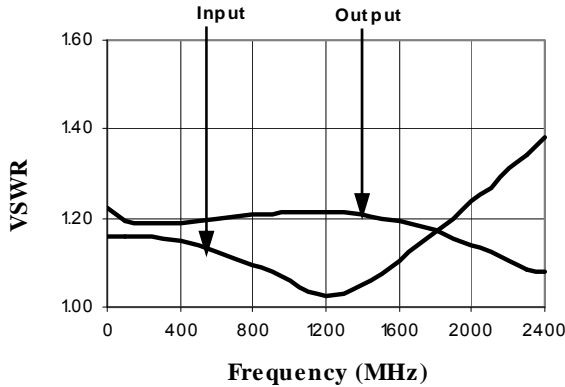

VSWR, Maximum Attenuation

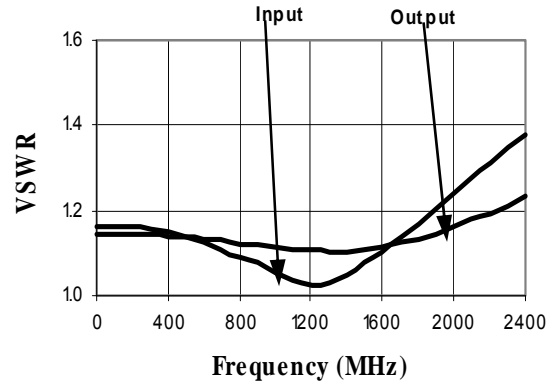

Maximum IP3 over Temperature Range and Attenuation @ 50 MHz

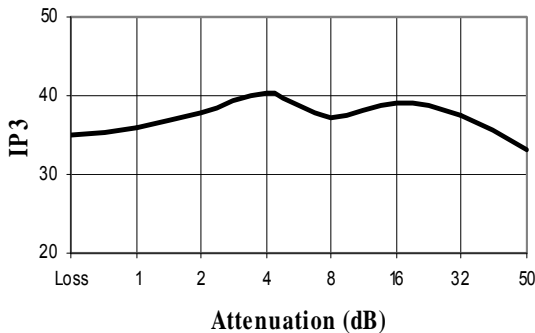

Maximum IP3 over Temperature Range and Attenuation @ 950 MHz

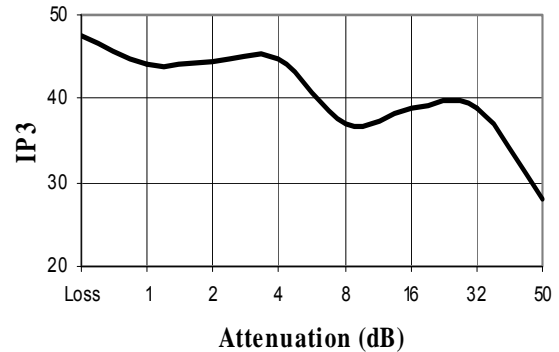

Maximum IP3 over Temperature Range and Attenuation @ 1900 MHz

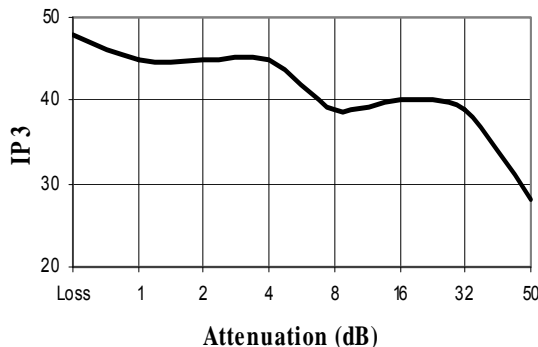

CSP-1, Lead-Free 4 x 6 mm, 32-lead PQFN[†]

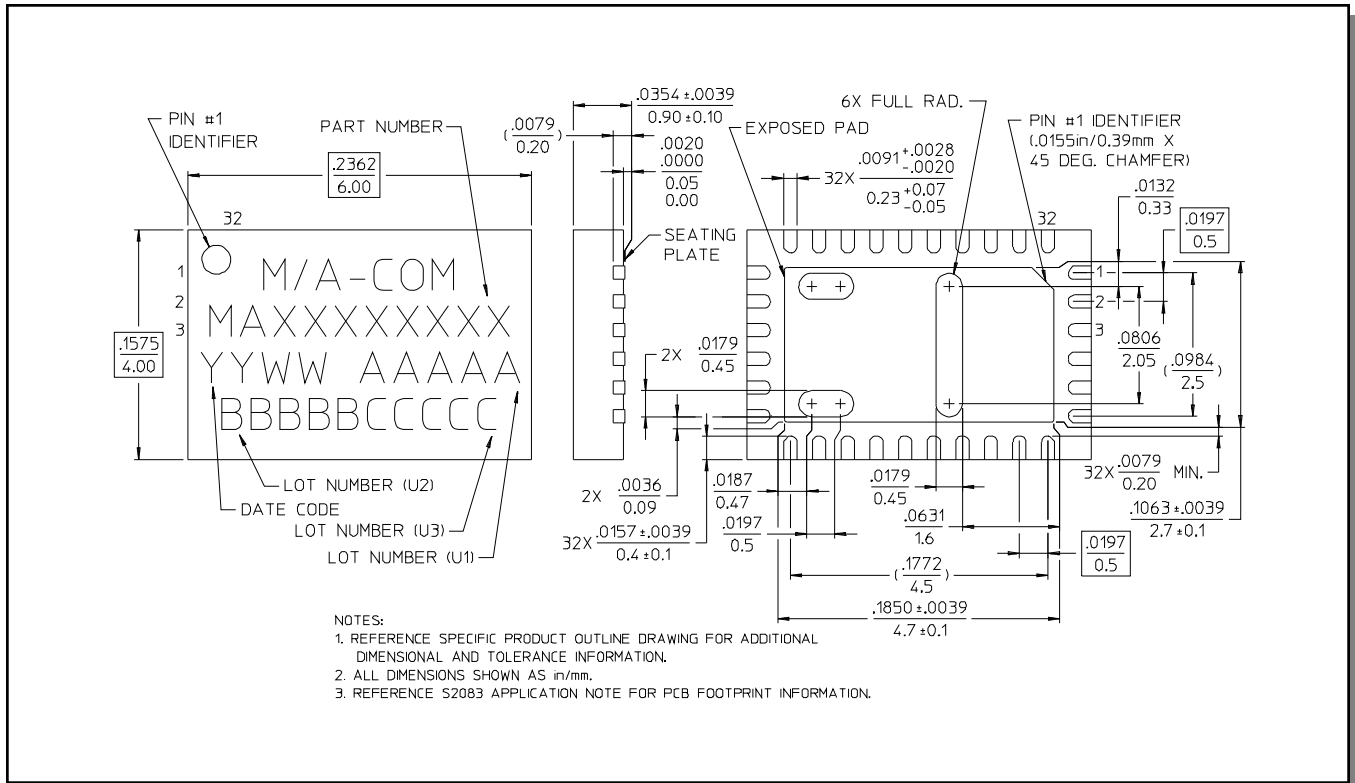

[†] Reference Application Note M538 for lead-free solder reflow recommendations.