

# MGA-22003

## 2.3-2.7 GHz 3x3mm WiMAX and WiFi Power Amplifier



### Data Sheet

#### Description

Avago Technologies MGA-22003 linear power amplifier is designed for mobile and fixed wireless data applications in the 2.3 to 2.7 GHz frequency range. The PA is optimized for IEEE 802.16 WiMAX/WiBro modulation but can be used for any high linearity applications. The PA exhibits flat gain and good match while providing linear power efficiency to meet stringent mask conditions. It utilizes Avago Technologies proprietary GaAs Enhancement-mode pHEMT technology for superior performance across voltage and temperature levels.

The MGA-22003 is packaged in a 3x3x1 mm package for space-constrained applications.

#### Applications

- Portable WiMAX/WiBro and WiFi applications
- WiMAX/WiBro and WiFi Access points

#### Functional Block Diagram

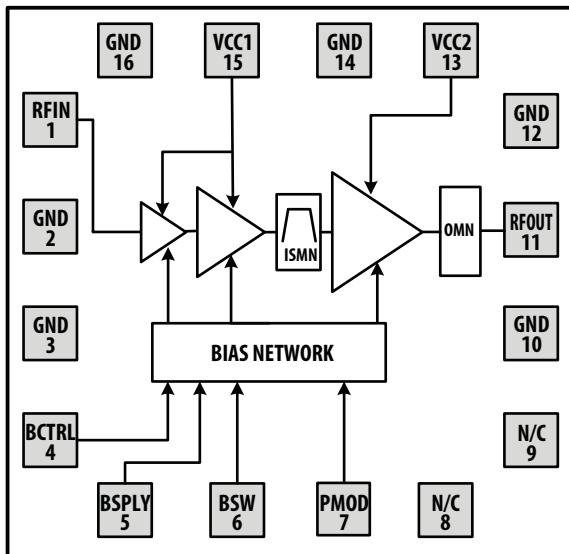

#### Features

- Advanced GaAs E-pHEMT
- 50 Ω all RF ports
- 9dB gain step in low power mode with I<sub>dsq</sub> reduction
- Integrated CMOS compatible pins for shutdown and low power mode
- 3 to 5V supply
- ESD protection all ports above 800V HBM
- Small size: 3 x 3 x 1 mm
- Stable under all loads or conditions
- -40°C to +85°C operation
- Integrated DC blocking capacitors for Input and Output pins.

#### Specifications (at 2.5GHz)

- Gain of 35dB
- PAE of 18% at SEM compliant P<sub>out</sub>=25dBm
- Meets 802.16 masks at 25 dBm P<sub>out</sub>, 16QAM WiMAX with 3.3V and 512mA
- 16QAM WiMAX EVM < -32dB (2.5%) at 25dBm
- Low power I<sub>dd</sub>, 80mA at P<sub>out</sub>=0dBm, 9dB Gain Step

#### Device Marking Instruction



3mm x 3mm x 1mm

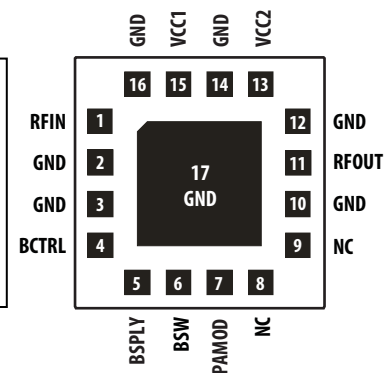

Top View

"22003" = Product Code

"KA" = Korea ASE

"YY" = Year code indicates the year of manufacture

"WW" = Workweek code indicates the workweek of manufacture

"XXXXX" = Last 5 digit of assembly lot number

## ELECTRICAL SPECIFICATIONS

### Absolute Minimum and Maximum Ratings

**Table 1. Minimum and Maximum Ratings**

Parameter		Specifications				Comments
Description	Pin	Min.	Typical	Max.	Unit	
Supply Voltage	VCC1 VCC2		3.3	5.5	V	
Bias Supply	BSPLY		3.3	4.2	V	
Bias Control	BCTRL		2.8	4.2	V	
Bias ON/OFF	BSW		1.8	4.2	V	
Mode Control	PAMODE		1.8	4.2	V	
RF Input Power	RFIN			15	dBm	Using 16QAM 3/4
MSL				MSL3		
Channel Temperature				150	°C	
Storage Temperature		-65		150	°C	
ESD	Human Body Model			800	V	
	Man Machine Model			50	V	

**Table 2. Operating Range**

Parameter		Specifications				Comments
Description	Pin	Min.	Typical	Max.	Unit	
Supply Voltage	VCC1 VCC2	3	3.3	5	V	
Bias Supply	BSPLY	3	3.3	3.5	V	
			13		mA	
Bias Control	BCTRL	2.75	2.8	2.85	V	
			.7		uA	
Bias ON/OFF	BSW	1.65	1.8	2.2	V	
			7		uA	
Mode Control	PAMODE	1.65	1.8	2.2	V	
			17		uA	
RF Output Power	RFOUT			25	dBm	Using 16QAM 3/4
Frequency Range		2.3		2.7	GHz	
Thermal Resistance, $\theta_{ch-b}$			23.4		°C/W	Channel to board
Case Temperature		-40		+85	°C	

## WiMAX (802.16e) Electrical Specifications

All data measured on an FR4 demo board at  $V_{cc1} = V_{cc2} = 3.3V$ ,  $T_c = 25^{\circ}C$ ,  $50 \Omega$  at all ports. Unless otherwise specified, all data is taken with OFDM 16-QAM  $\frac{3}{4}$  convolutional coding modulated signal per IEEE 802.16e with 10MHz BW operating over the BW of 2.3GHz to 2.7GHz.

**Table 3. RF Electrical Characteristics**

Parameter	Performance			Unit	Comments	
	Min.	Typical	Max.			
Input Return Loss		-10		dB		
Gain Flatness		1		dB	Over any 10MHz	
Gain Variation ( $V_{CC}$ )	-1		1	dB	3V to 5V	
High Power Mode	EVM		-32	-27	dB	$V_{cc}=3.3V$
			-34	-30		$V_{cc}=3.6V$
	SEM-A @5.05MHz		-30.6	-13	dBm/100kHz	IBW=100kHz
	SEM-B @6.5MHz		-22.3	-13	dBm/MHz	IBW=1MHz
	SEM-C @10.5MHz		-26.6	-19		
	SEM-D @11.5MHz		-27.5	-25		
	SEM-E @15.5MHz		-35.3	-29.5		
	SEM-F @20.5MHz		-42.5	-37		
	Pout (SEM Compliant)	+25			dBm	802.16e
	Total DC Current		501	560	mA	Pout=25dBm
		464			Pout=24dBm	
Gain	32	35	38	dB		
Low Power Mode	EVM		-30	-	dB	Pout=0dBm
	Gain Step	8	10	15	dB	
	Total DC Current		70		mA	Pout=0dBm
P1dB		31		dBm	CW Single Tone	
Psat		32		dBm	CW Single Tone	
2fo		-12	-10	dBm/MHz	2.3-2.4GHz	
		-29	-27		2.5-2.7GHz	
3fo		-35	-27	dBm/MHz		
Settling Time	0.2	0.5		uS		
Icc leakage current		10	40	uA		
Noise Power in Cell Band		-142		dBm/Hz		
Noise Power in GPS Band		-133		dBm/Hz		
Noise Power in PCS		-137		dBm/Hz		

## Selected performance plots

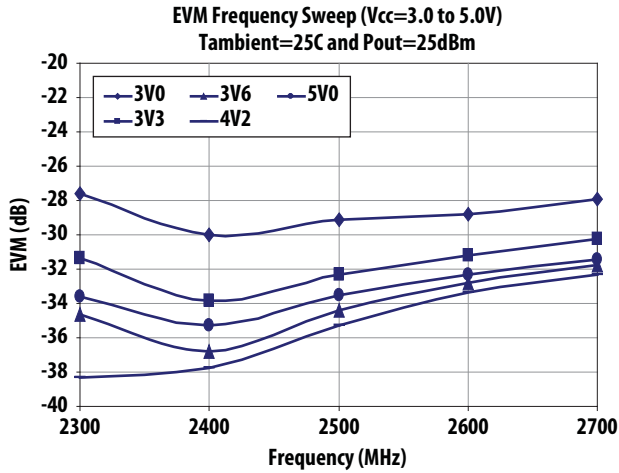

Figure 1. EVM Frequency Sweep at 25C and Pout=25dBm over Vcc

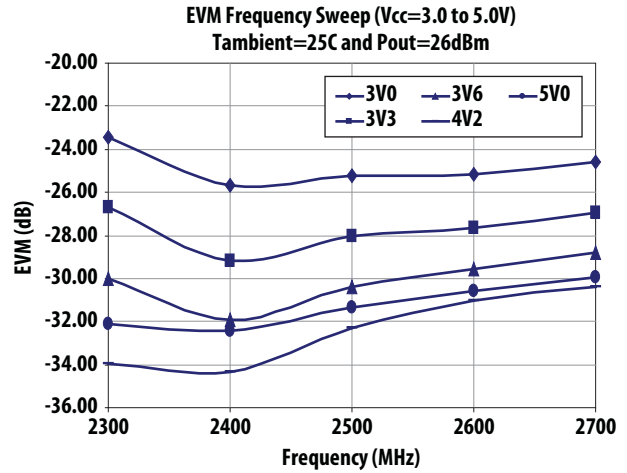

Figure 2. EVM Frequency Sweep at 25C and Pout=26dBm over Vcc

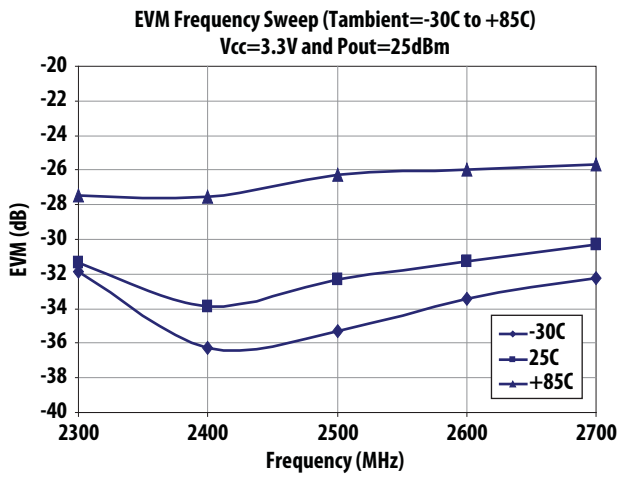

Figure 3. EVM Frequency Sweep at Vcc=3.3V and Pout=25dBm over Tambient

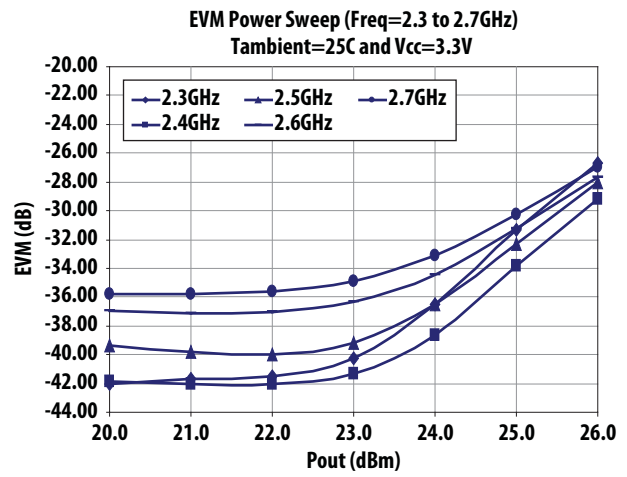

Figure 4. EVM Power Sweep at Vcc=3.3V and 25C over Frequency

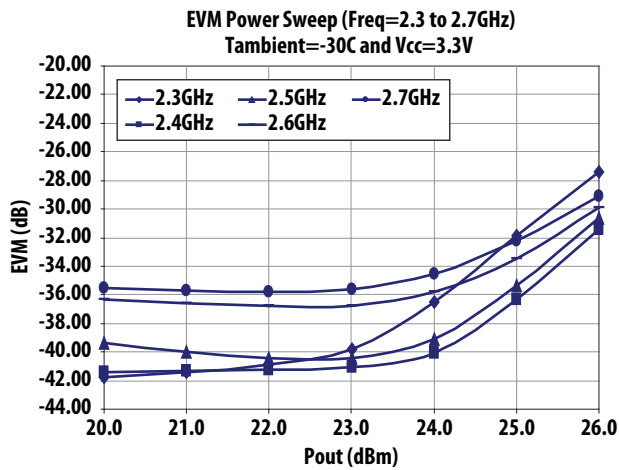

Figure 5. EVM Power Sweep at Vcc=3.3V and -30C over Frequency

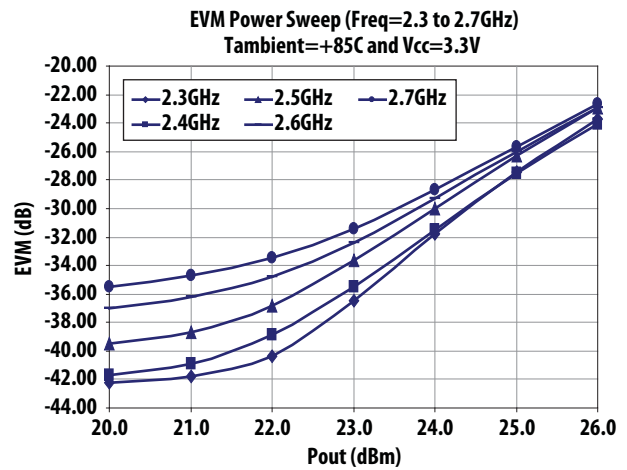

Figure 6. EVM Power Sweep at Vcc=3.3V and +85C over Frequency

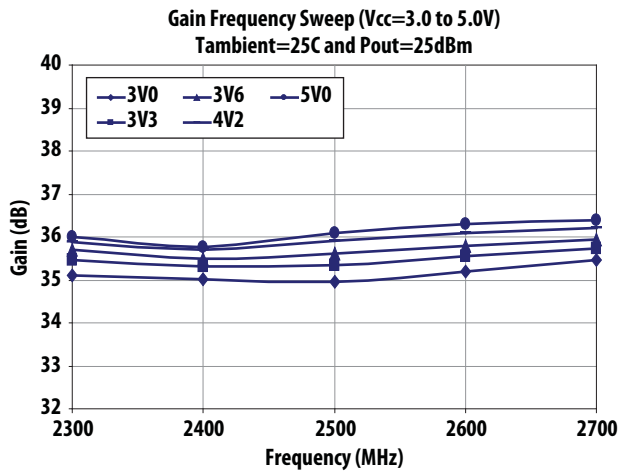

Figure 7. Gain Frequency Sweep at 25C and Pout=25dBm over Vcc

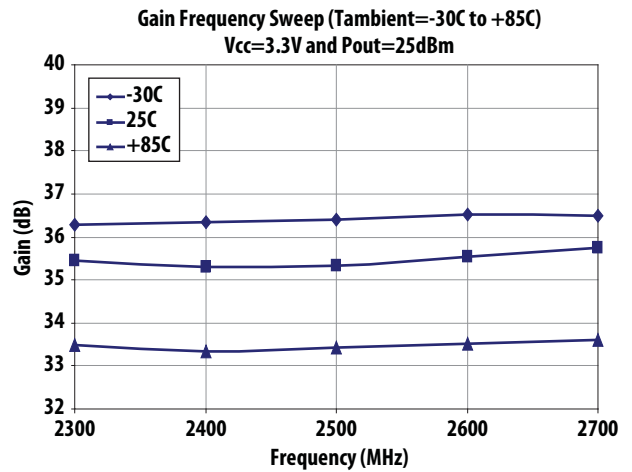

Figure 8. Gain Frequency Sweep at Vcc=3.3V and Pout=25dBm over Tambient

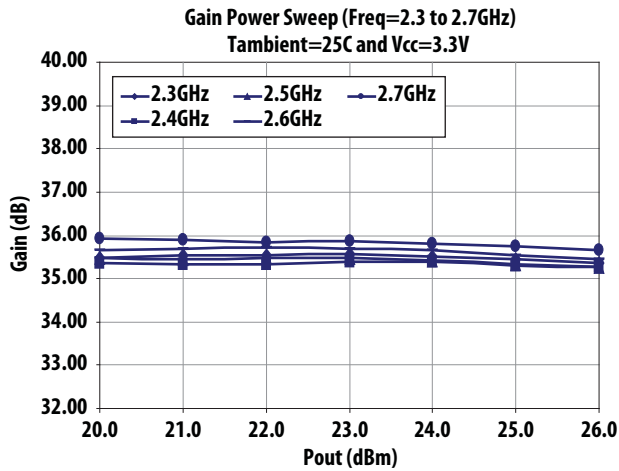

Figure 9. Gain Power Sweep at Vcc=3.3V and 25C over Pout

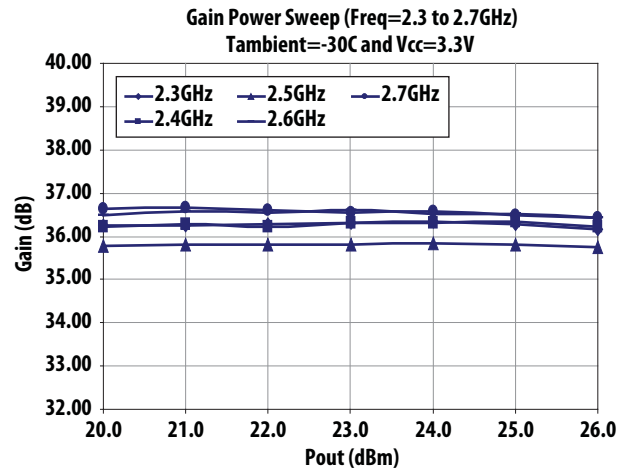

Figure 10. Gain Power Sweep at Vcc=3.3V and -30C over Pout

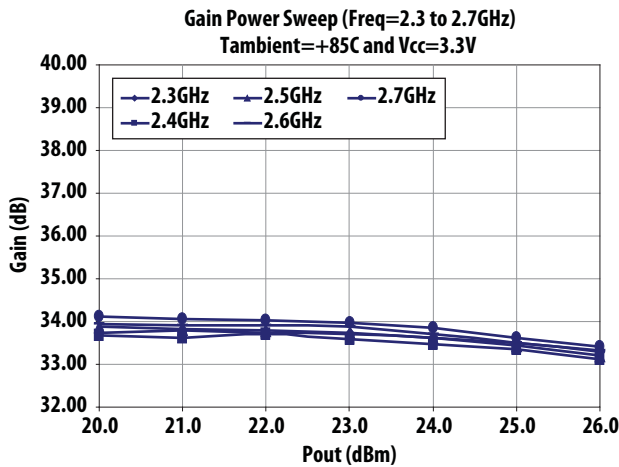

Figure 11. Gain Power Sweep at Vcc=3.3V and +85C over Pout

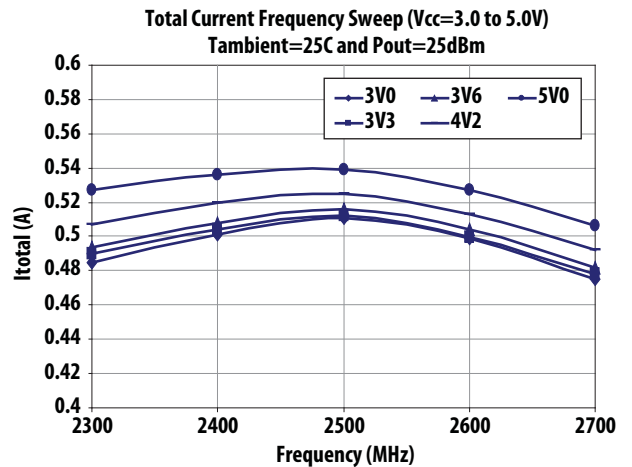

Figure 12. Total Current Frequency Sweep at 25C and Pout=25dBm over Vcc

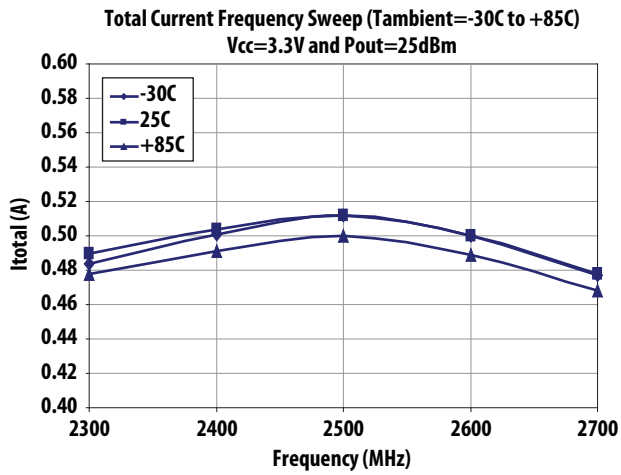

Figure 13. Total Current Frequency Sweep at 3.3V and Pout=25dBm over Tambient

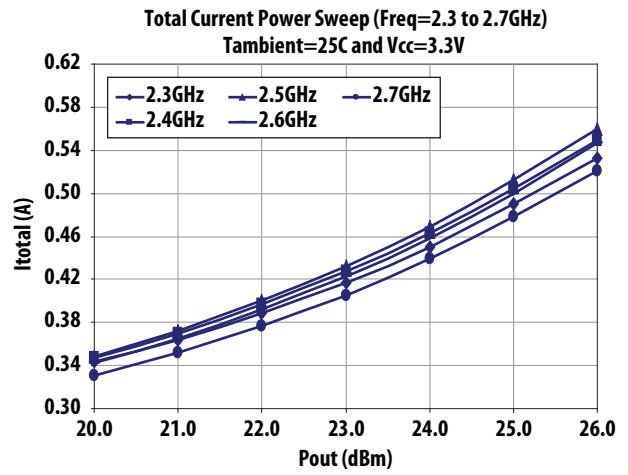

Figure 14. Total Current Power Sweep at 3.3V and 25C over Frequency

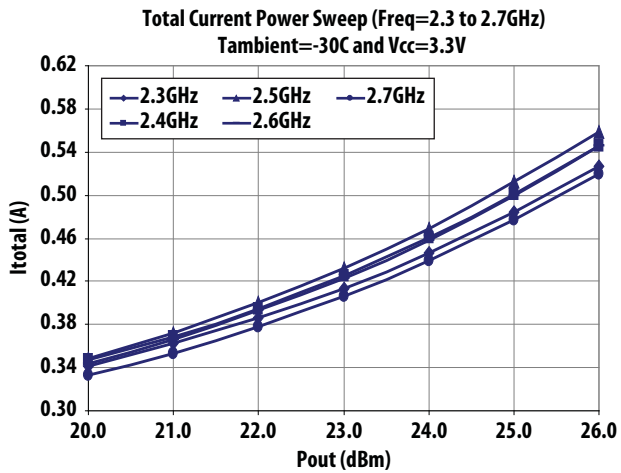

Figure 15. Total Current Power Sweep at 3.3V and -30C over Frequency

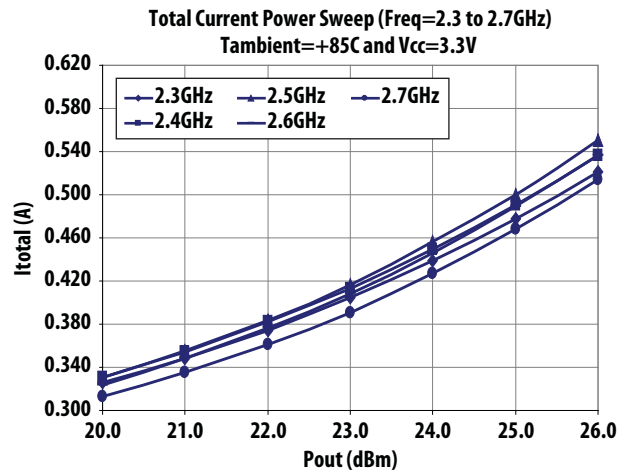

Figure 16. Total Current Power Sweep at 3.3V and +85C over Frequency

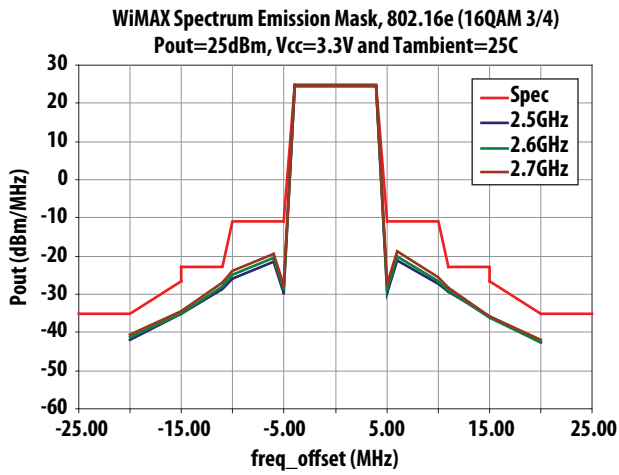

Figure 17. SEM Frequency Sweep at Vcc=3.3V and 25C (2dB Post-PA loss assumed)

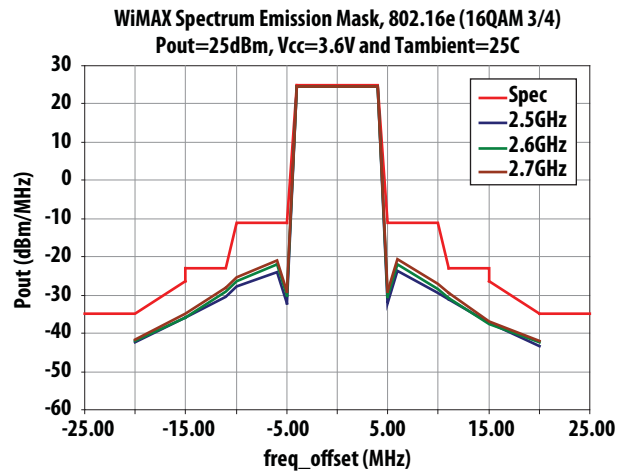

Figure 18. SEM Frequency Sweep at Vcc=3.6V and 25C (2dB Post-PA loss assumed)

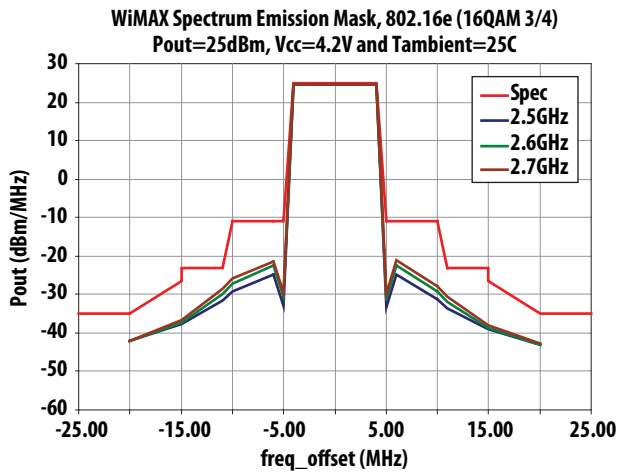

Figure 19. SEM Frequency Sweep at Vcc=4.2V and 25C (2dB Post-PA loss assumed)

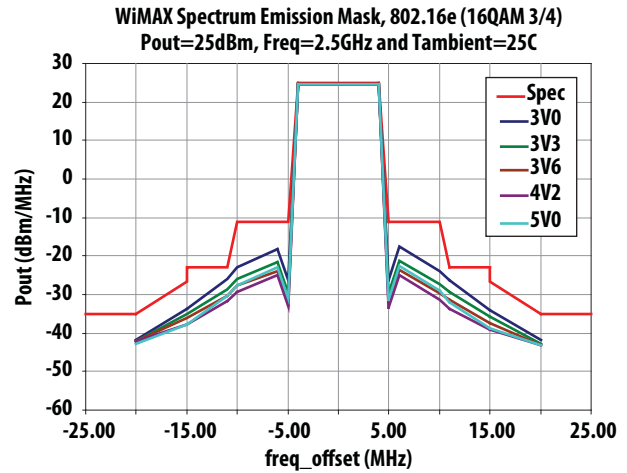

Figure 20. SEM at Vcc=3.3V, 25C and 2.5GHz over Vcc (2dB Post-PA loss assumed)

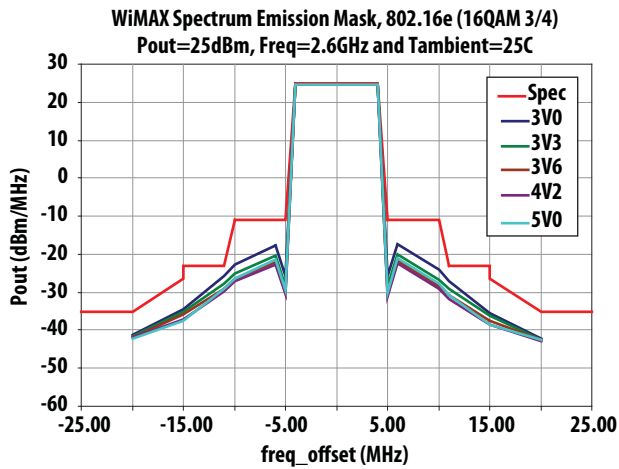

Figure 21. SEM at Vcc=3.3V, 25C and 2.6GHz over Vcc (2dB Post-PA loss assumed)

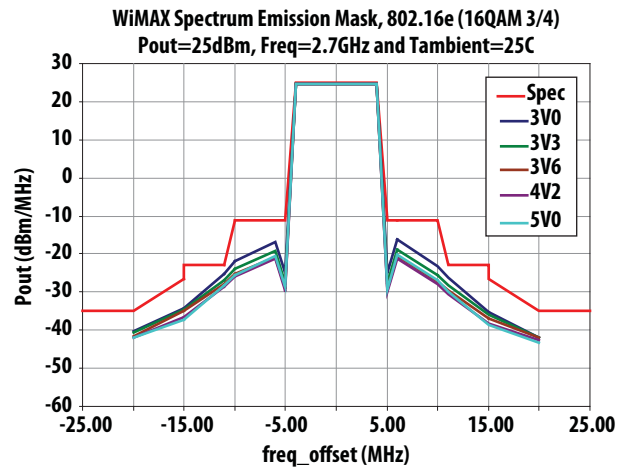

Figure 22. SEM at Vcc=3.3V, 25C and 2.7GHz over Vcc (2dB Post-PA loss assumed)

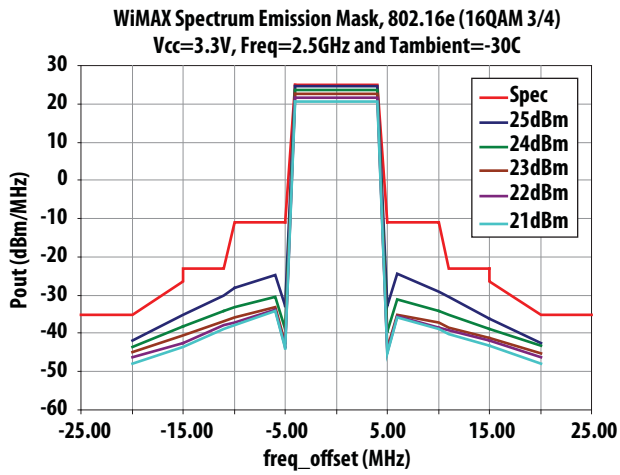

Figure 23. SEM at Vcc=3.3V, -30C and 2.5GHz over Vcc (2dB Post-PA loss assumed)

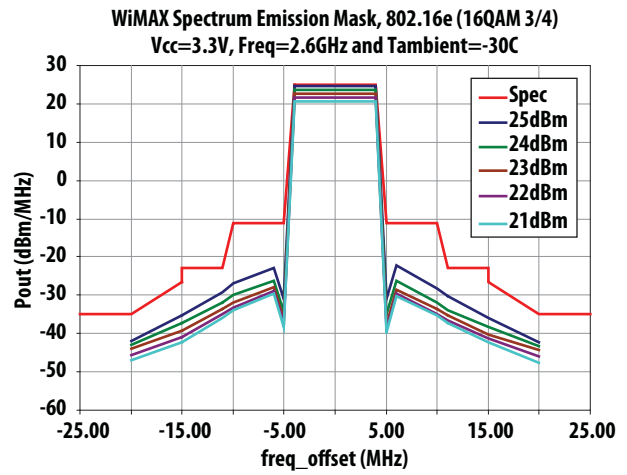

Figure 24. SEM at Vcc=3.3V, -30C and 2.6GHz over Vcc (2dB Post-PA loss assumed)

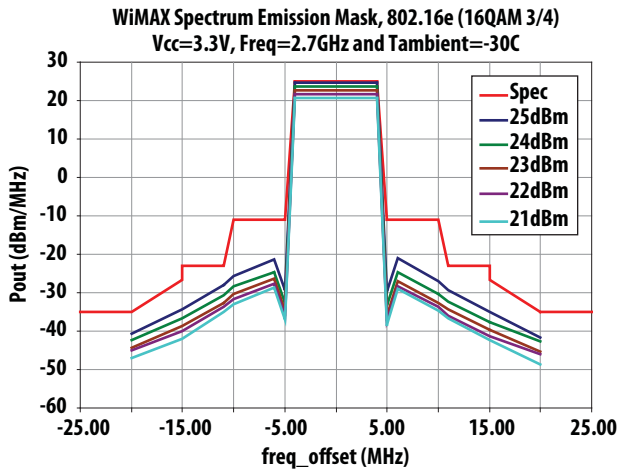

Figure 25. SEM at Vcc=3.3V, -30C and 2.7GHz over Vcc (2dB Post-PA loss assumed)

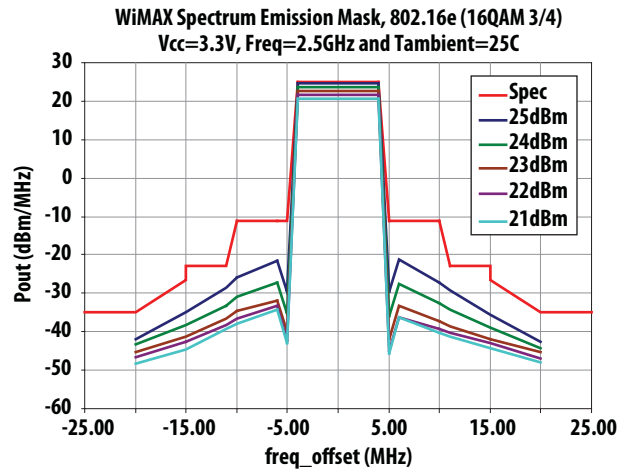

Figure 26. SEM at Vcc=3.3V, 25C and 2.5GHz over Vcc (2dB Post-PA loss assumed)

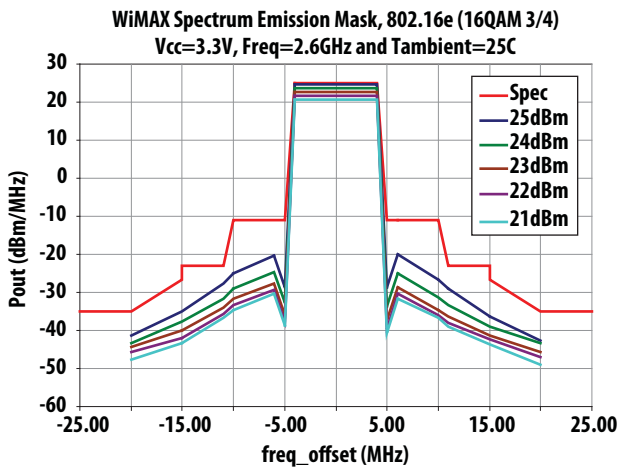

Figure 27. SEM at Vcc=3.3V, 25C and 2.6GHz over Vcc (2dB Post-PA loss assumed)

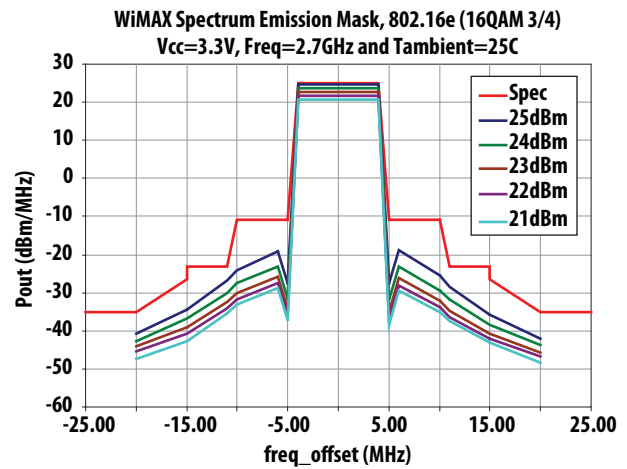

Figure 28. SEM at Vcc=3.3V, 25C and 2.7GHz over Vcc (2dB Post-PA loss assumed)



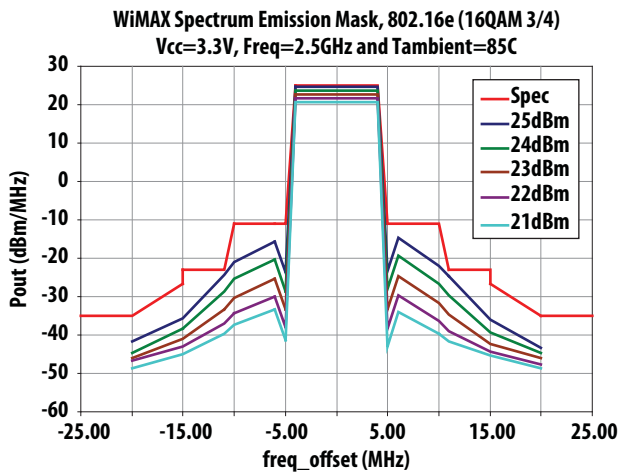

Figure 29. SEM at Vcc=3.3V, +85C and 2.5GHz over Vcc (2dB Post-PA loss assumed)

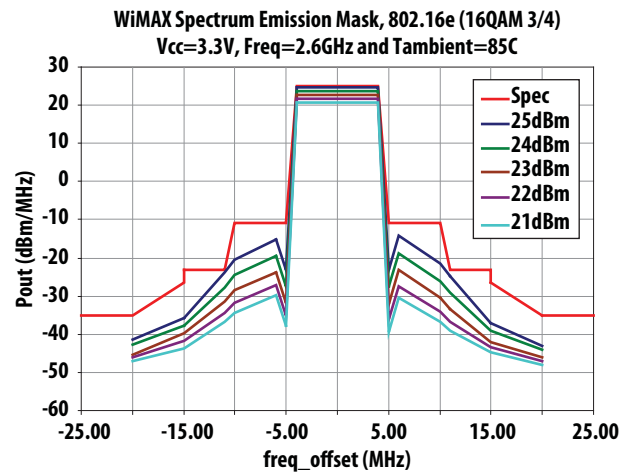

Figure 30. SEM at Vcc=3.3V, +85C and 2.6GHz over Vcc (2dB Post-PA loss assumed)

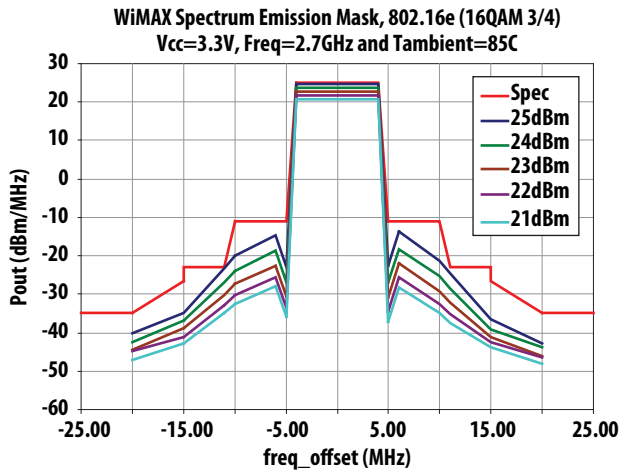

Figure 31. SEM at Vcc=3.3V, +85C and 2.7GHz over Vcc (2dB Post-PA loss assumed)

## Evaluation Board Description

**Table 4. Evaluation Board Pin Description**

Top Pin No.	Function	Bottom Pin No.	Function
1	VCC2	2	VCC2_S
3	B_SPLY	4	GND
5	VCC1	6	GND
7	PAMOD	8	GND
9	PAMOD	10	GND
11	NC	12	GND
13	NC	14	B_SW
15	B_CTRL	16	GND
17	NC	18	GND
19	NC	20	GND

Recommended turn on sequence

- Apply VCC1 and VCC2 3.3V
- Apply BSPLY 3.3V
- Apply BCTRL 2.8V
- Apply BSW 1.8V
- For HPM Apply PAMOD 1.8V for LPM Apply PAMOD 0V
- Apply RF In, not to exceed 15dBm

### Typical Test Conditions:

Pin	HPM	LPM	
VCC1,2	3.3V	3.3V	Supply Voltage
PAMOD	1.8V	0V	Low Power Mode
B_SPLY	3.3V	3.3V	Bias Voltage
B_CTRL	2.8V	2.8V	Bias Control
B_SW	1.8V	1.8V	PA Enable

Notes: VCC1, VCC2 and B\_SPLY can be tied together to reduce supply voltages, but B\_CTRL needs to be a regulated voltage which is optimized for 2.8V.

### Demoboard Top Pins



### Demoboard Bottom Pins



## Application Circuit MGA-22003

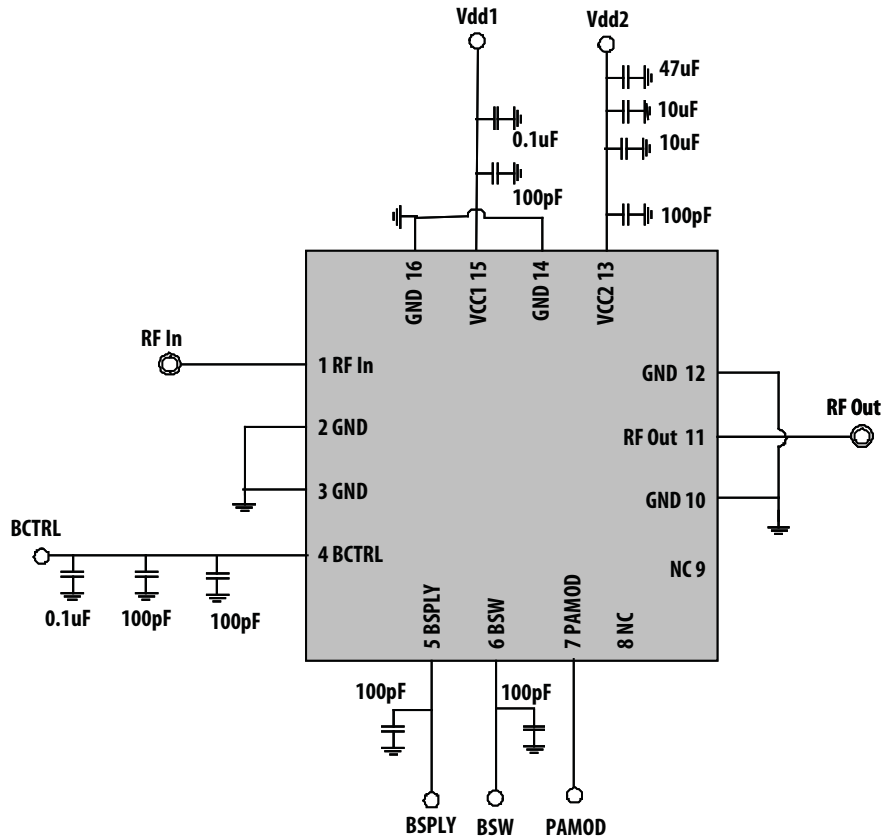

### Using 3.3V or 5V Supply and connecting Vcc1, Vcc2, BSLPY and BCTRL

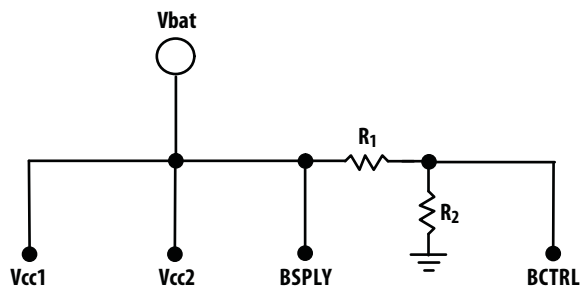

Notes: BCTRL regulates the device current, thus R1 and R2 should have good tolerance rating. If available, a voltage regulator is the preferred method of bias.

In this example we set R2 at 10MΩ and solve for R1 with simple voltage divider equation. Use high resistance values to limit leakage current.

#### 3.3V Example :

$$V_{BCTRL} = \frac{R_2}{R_1 + R_2} * V_{BATT}$$

$$2.85V = \frac{10M\Omega}{R_1 + 10M\Omega} * 3.3V$$

$$R_1 = 1.58M\Omega$$

$$R_2 = 10M\Omega$$

#### Given :

$$V_{BCTRL} = 2.85V$$

$$V_{BAT} = 3.3V$$

$$R_2 = 10M$$

$$R_1 = ?$$

#### 5.0V Example :

$$V_{BCTRL} = \frac{R_2}{R_1 + R_2} * V_{BATT}$$

$$2.85V = \frac{10M\Omega}{R_1 + 10M\Omega} * 5.0V$$

$$R_1 = 7.54M\Omega$$

$$R_2 = 10M\Omega$$

#### Given :

$$V_{BCTRL} = 2.85V$$

$$V_{BAT} = 5.0V$$

$$R_2 = 10M$$

$$R_1 = ?$$

## Flexible BCTRL Optimization

BCTRL voltage on MGA-22003 directly controls the bias current of the device. If the user requires lower current or perhaps higher power than the typical operation, then this can be accomplished by a simple BCTRL change. A more sophisticated use might include BCTRL as part of a closed loop system where software dynamically adjusts BCTRL depending on the output power required.

### Low Current Operation: 400mA at 25dBm Pout with BCTRL = 1.8V and VCC = 3.3V

Example 1 is very typical of mobile device application where ~400mA of current consumption is required. With the above settings at full power of 25dBm, IDD drops from 500mA to 418mA with some trade-off in EVM but still meeting SEM.

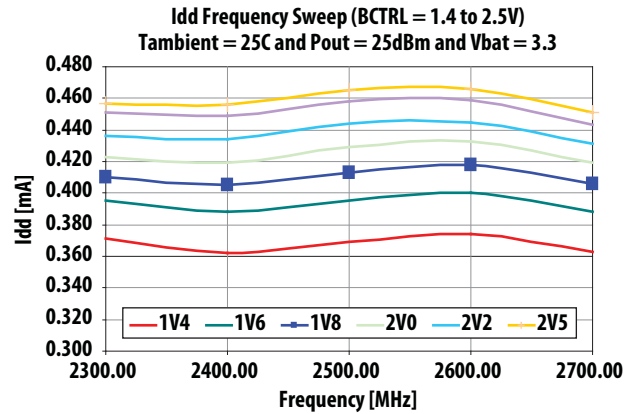

**Table 5. Low Current Biasing**  
 Optimal settings for BCTRL (2.3G - 2.7G)

VCC = BSPLY = 3.3V			
Pout	BCTRL	Idd	EVM
25dBm	1.8V	418mA	-27.9dB
24dBm	1.7V	367mA	-27.6dB
23dBm	1.7V	330mA	-27.0dB
Idsq	x	94mA	x

**Table 6. Typical Biasing**  
 Typical settings for BCTRL (2.3G - 2.7G)

VCC = BSPLY = 3.3V			
Pout	BCTRL	Idd	EVM
25dBm	2.8V	501mA	-32dB
24dBm	2.8V	464mA	-33dB
23dBm	2.8V	435mA	-35dB
Idsq	x	240mA	x

### Hi Power Operation: 26dBm Pout with BCTRL = 2V and VCC = 5V

Example 2 is more typical of CPE applications where current consumption is less important and higher power is required. With BCTRL at 2V and VCC at 5V MGA-22003 is able to achieve higher than 26dBm Pout and still meet SEM. Generally as VCC increases SEM improves.

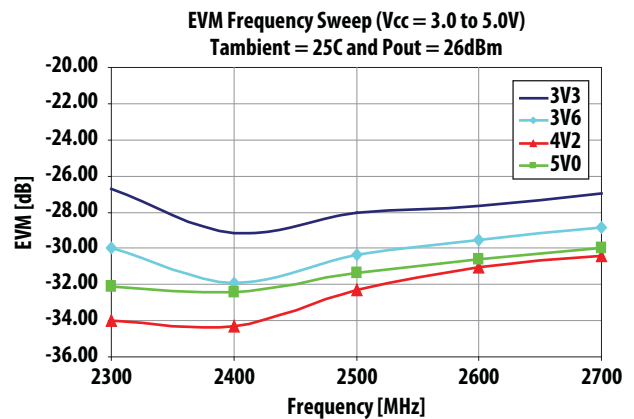

# Land Pattern

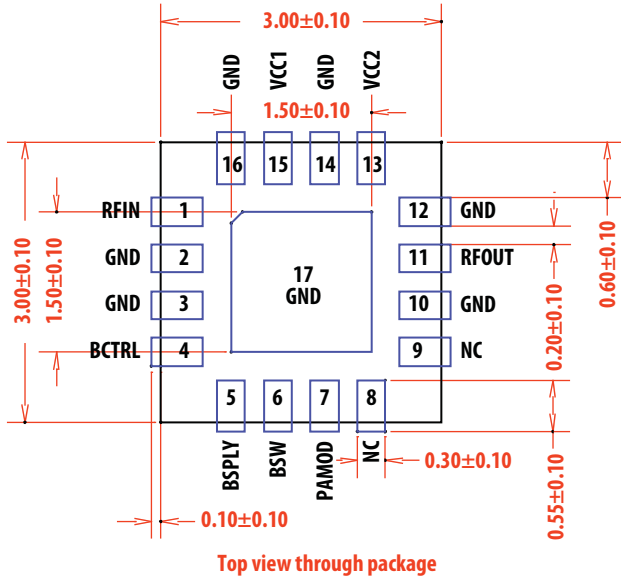

Figure 32. Recommended footprint

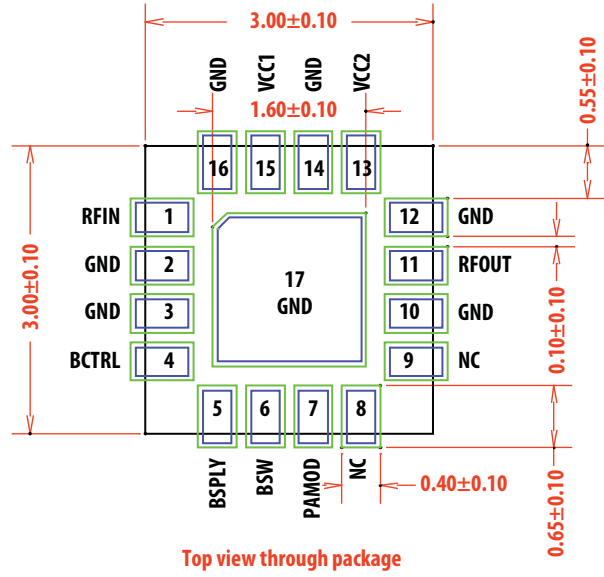

Figure 33. Recommended soldermask opening

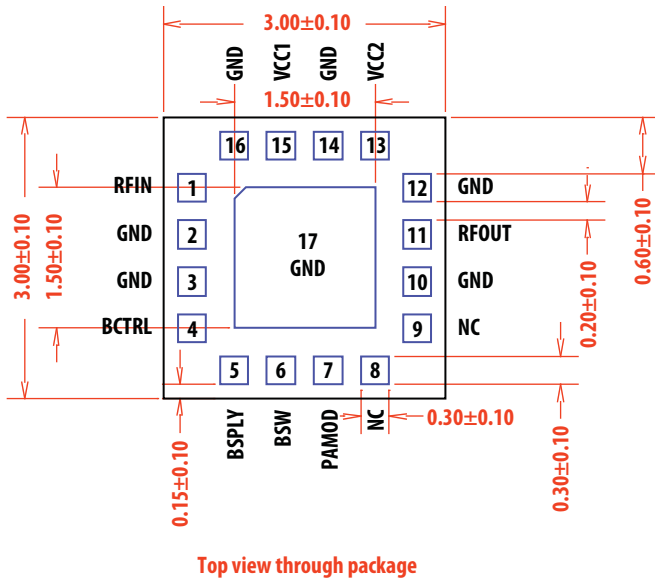
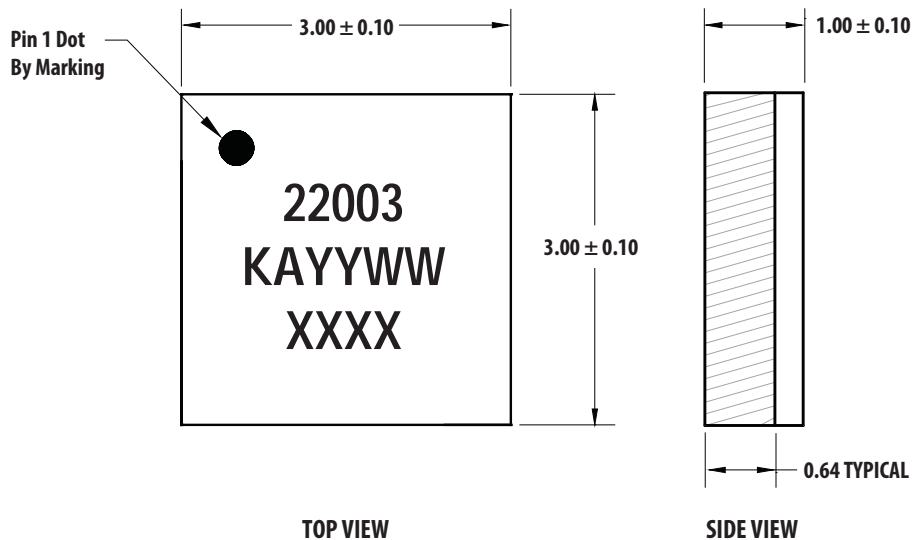

Figure 34. Package dimensions

- Notes:
1. All units are in millimeters
  2. package is symmetrical

## Package Dimensions



### Note

1. All dimensions are in millimeters.
2. Dimensions are inclusive of plating.
3. Dimensions are exclusive of mold flash and metal burr.

## Ordering Information

Part Number	No. of Devices	Container
MGA-22003-BLK	100	Antistatic Bag
MGA-22003-TR1	3000	7" Reel
MGA-22003-TR2	7000	13" Reel

## Device Orientation

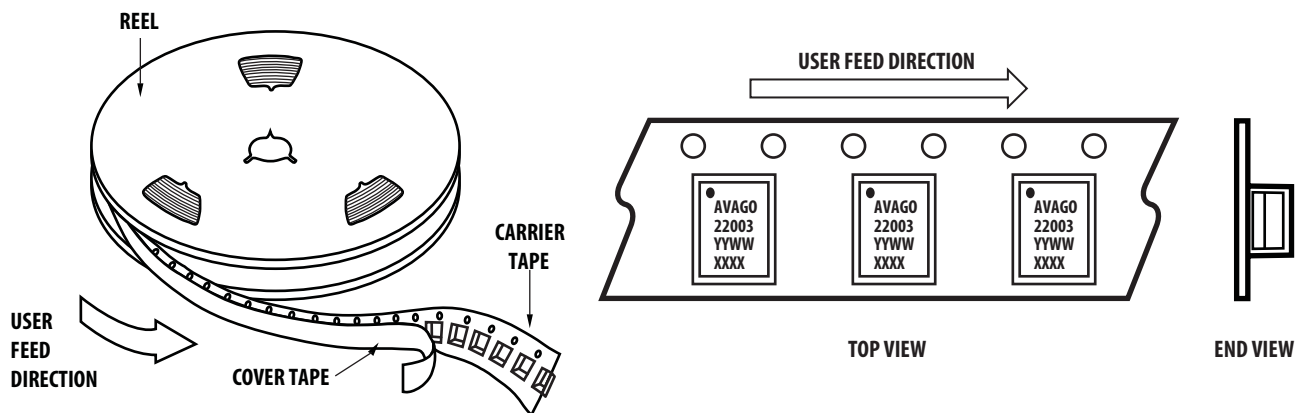

## Tape and Reel Information

### Reel Dimensions

Size	12mm
A	330 <sup>+2.0</sup> <sub>-2.0</sub>
B	1.5min.
C	13.0 <sup>+0.5</sup> <sub>-0.2</sub>
D	20.2min.
N	100 <sup>+3.0</sup> <sub>-0.0</sub>
W1	12.4 <sup>+3.0</sup> <sub>-0.0</sub>
W2	16.4 <sup>+2.0</sup> <sub>-2.0</sub>
W3	13.65 <sup>+1.75</sup> <sub>-0.75</sub>

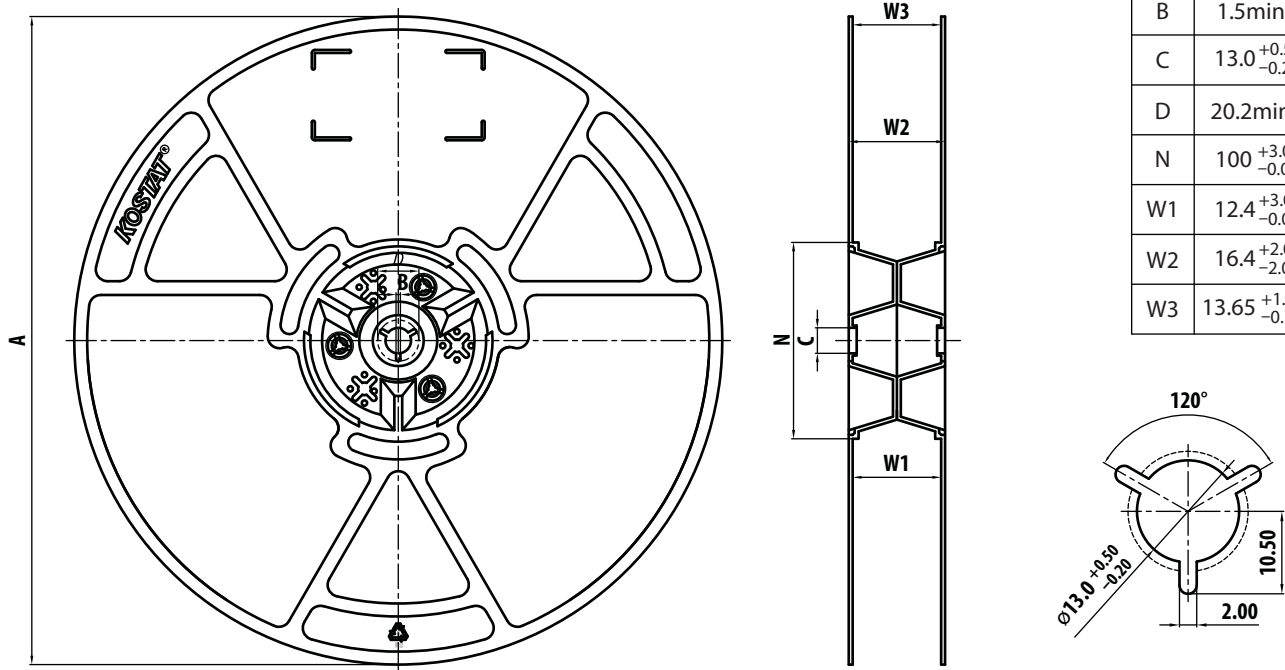

### Tape Dimensions

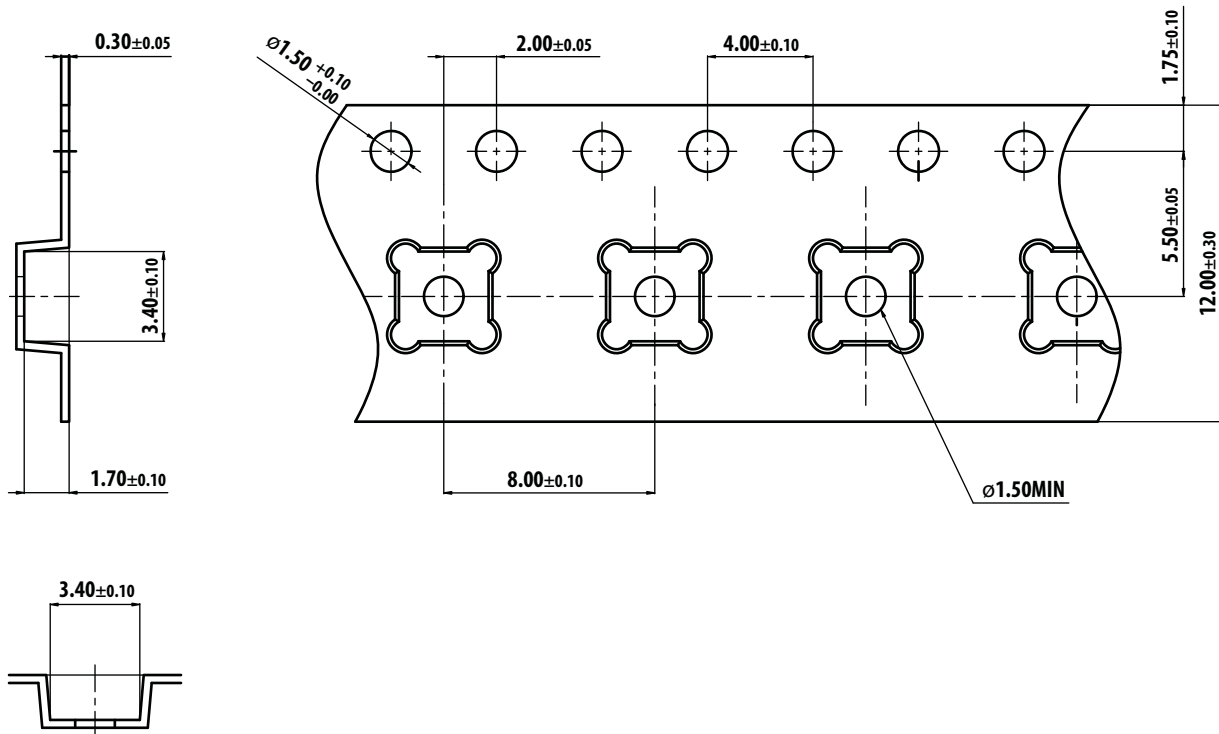

## Handling and Storage

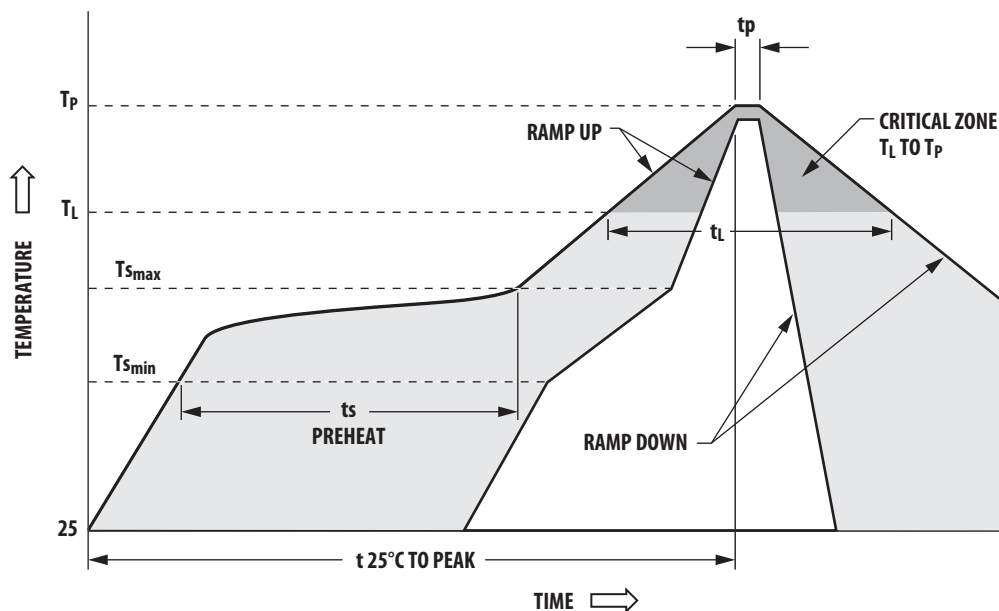

### Typical SMT Reflow Profile for Maximum Temperature = $260 \pm 0/-5^\circ\text{C}$

Profile Feature	Sn-Pb Solder	Pb-Free Solder
Average ramp-up rate (TL to TP)	3°C/sec max	3°C/sec max
Preheat		
– Temperature Min (T <sub>min</sub> )	100°C	100°C
– Temperature Max (T <sub>max</sub> )	150°C	150°C
– Time (min to max) (t <sub>s</sub> )	60-120 sec	60-180 sec
T <sub>max</sub> to TL		
– Ramp-up Rate		3°C/sec max
Time maintained above:		
– Temperature (TL)	183°C	217°C
– Time (TL)	60-150 sec	60-150 sec
Peak temperature (T <sub>p</sub> )	240 $\pm 0/-5^\circ\text{C}$	260 $\pm 0/-5^\circ\text{C}$
Time within 5°C of actual Peak Temperature (t <sub>p</sub> )	10-30 sec	10-30 sec
Ramp-down Rate	6°C/sec max	6°C/sec max
Time 25°C to Peak Temperature	6 min max	8 min max

For product information and a complete list of distributors, please go to our web site: [www.avagotech.com](http://www.avagotech.com)

Avago, Avago Technologies, and the A logo are trademarks of Avago Technologies in the United States and other countries. Data subject to change. Copyright © 2005-2012 Avago Technologies. All rights reserved.  
AV02-1959EN - October 2, 2012

**AVAGO**  
TECHNOLOGIES