

Industrial waterproof rectangular connector

DK-3 Series (4 Pin) Type

DDK Ltd.

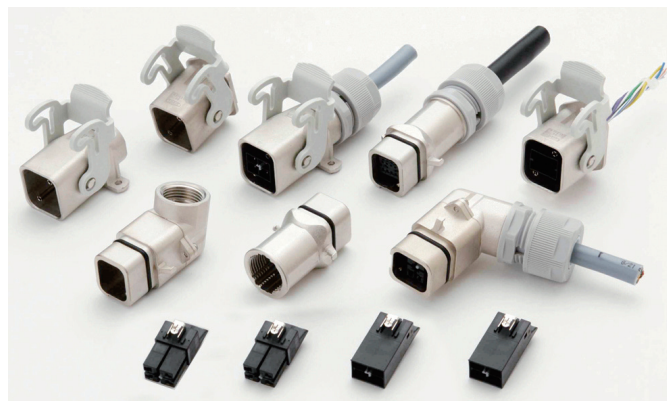

OUTLINE

- ◆ Waterproof rectangular connector was developed for connecting industrial equipment.
- ◆ Crimp termination contacts are the same as those of DK-3000 series.
- ◆ Plug, Cable Connecting, offers a receptacle and the receptacle shell shape tab. key can be changed for wrong insertion prevention, so it's possible to combine a colorful connector.
- ◆ DK-3 has one touch locking lever mechanism and a locking supporting system. Pushing contacts in the direction of the mating half makes the connectors automatically and temporarily locked and you can mate the connectors easily.

APPLICATIONS

FA equipment (internal and external), robots, servo motors, medical equipment, communication equipment, OA equipment, various other electrical equipment

SPECIFICATIONS

Item	DK-3 Series
Rated Voltage	250V AC(r.m.s.)/600V DC
Rated Current	15A max. / Contact
Dielectric Withstanding Voltage	2,200V AC(r.m.s.)/ 1minute
Insulation Resistance	1,000M Ω min. at 500V DC
Contact Resistance	10m Ω max.
Contact Pitch	5.0mm
Applicable Cable Size	AWG 16 – 28
Waterproof Rating	IP67
Number of Contacts	4 Pin

SAFETY STANDARD



MATERIALS / FINISH



Item	Materials / Finishes
Contact	Copper Alloy / Au over Ni Plating
Housing	PBT Resin(UL94V-0) / Black
Shell / Hood	Aluminum Alloy and Zinc Alloy

© Specifications and/or dimensions in this catalogue are subject to change without notice.
Your catalogue checking the latest specifications with our drawings would be highly appreciated.

▶ 4 Pin Waterproof Connectors

Straight Plug

DK-3P04B □□□ -S

Housing Type RC : Receptacle Housing TC : Tab Housing	Keying Type Omit : Normal Key X : X Key, Y : Y Key, Z : Z Key
---	---

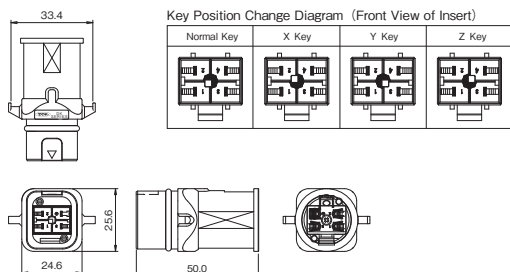

Tab Housing

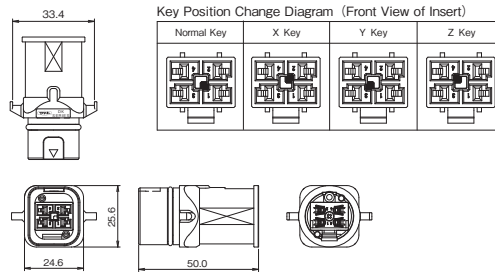

Receptacle Housing

Straight Plug [With Earth Lug]

DK-3P04B □□□ -ES

Housing Type RC : Receptacle Housing TC : Tab Housing	Keying Type Omit : Normal Key X : X Key, Y : Y Key, Z : Z Key
---	---

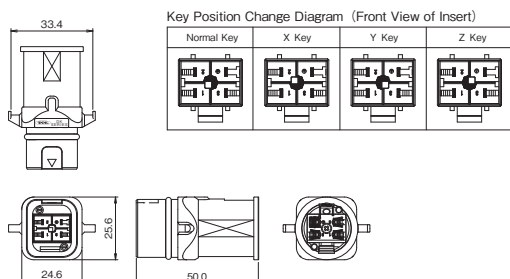

Tab Housing

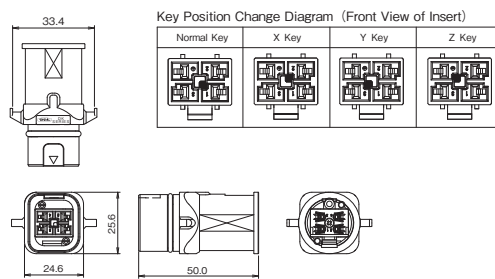

Receptacle Housing

Angle Plug

DK-3AP04B □□□ -S

Housing Type RC : Receptacle Housing TC : Tab Housing	Keying Type Omit : Normal Key X : X Key, Y : Y Key, Z : Z Key
---	---

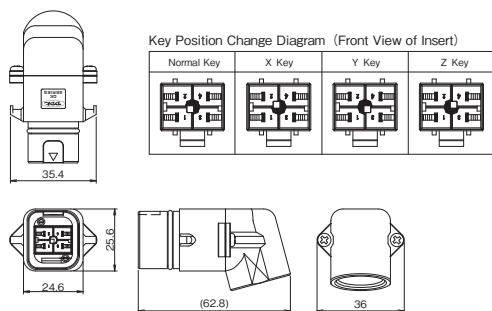

Tab Housing

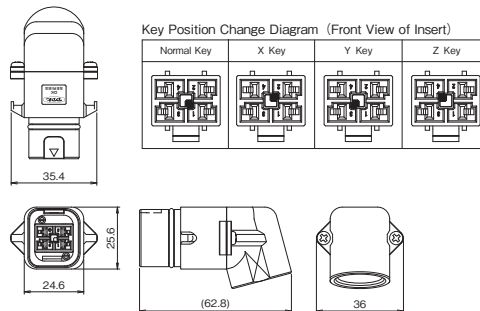

Receptacle Housing

© Specifications and/or dimensions in this catalogue are subject to change without notice.
 Your catalogue checking the latest specifications with our drawings would be highly appreciated.

▶ 4 Pin Waterproof Connector

Angle Plug [With Earth Lug]

DK-3AP04B □□□ -ES

Housing Type
 RC : Receptacle Housing
 TC : Tab Housing

Keying Type
 Omit : Normal Key
 X : X Key, Y : Y Key, Z : Z Key

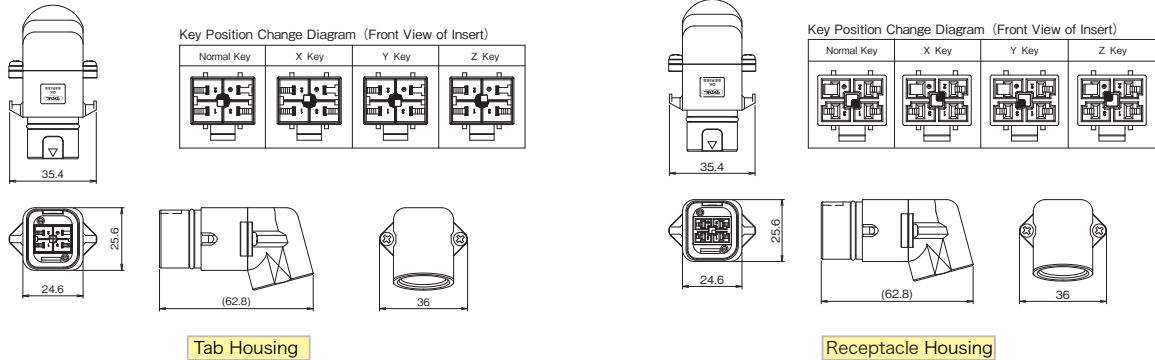

Cable Receptacle

DK-3CR04B □□□ -S

Housing Type
 RC : Receptacle Housing
 TC : Tab Housing

Keying Type
 Omit : Normal Key
 X : X Key, Y : Y Key, Z : Z Key

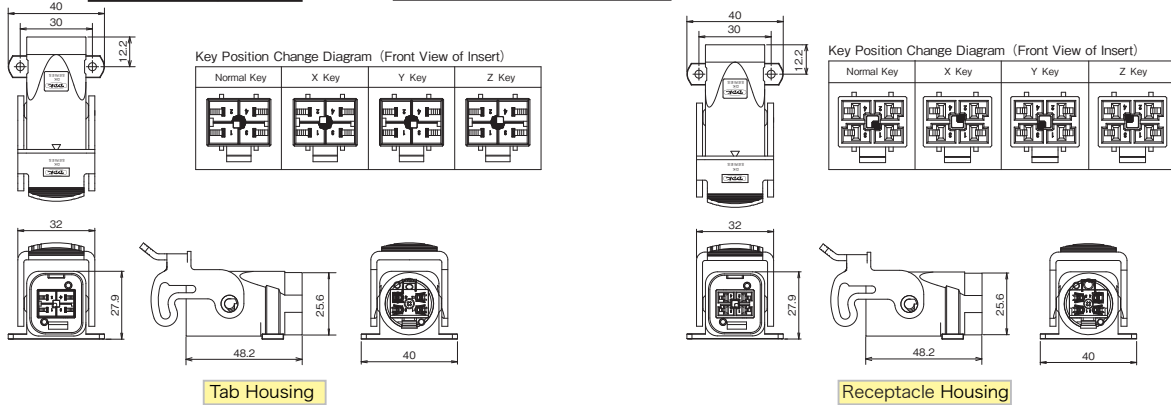

Cable Receptacle [With Earth Lug]

DK-3CR04B □□□ -ES

Housing Type
 RC : Receptacle Housing
 TC : Tab Housing

Keying Type
 Omit : Normal Key
 X : X Key, Y : Y Key, Z : Z Key

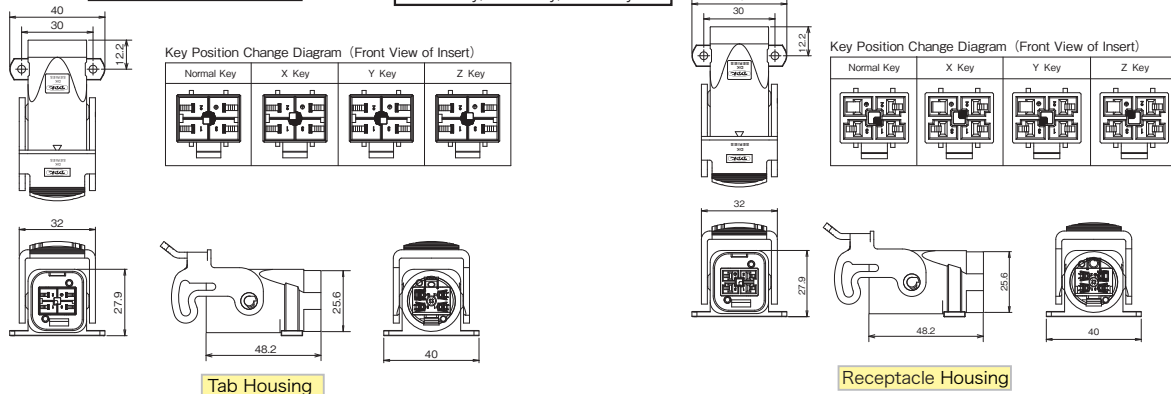

© Specifications and/or dimensions in this catalogue are subject to change without notice.
 Your catalogue checking the latest specifications with our drawings would be highly appreciated.

▶ 4 Pin Waterproof Connector

Receptacle

DK-3R04B □ □ □ -S

Housing Type RC : Receptacle Housing TC : Tab Housing	Keying Type Omit : Normal Key X : X Key, Y : Y Key, Z : Z Key
--	--

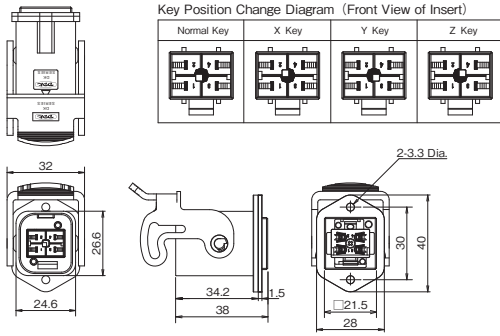

Tab Housing

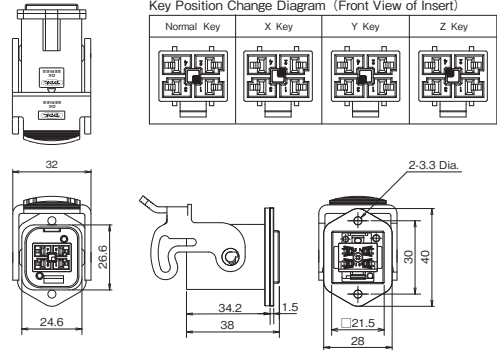

Receptacle Housing

Receptacle [With Earth Lug]

DK-3R04B □ □ □ -ES

Housing Type RC : Receptacle Housing TC : Tab Housing	Keying Type Omit : Normal Key X : X Key, Y : Y Key, Z : Z Key
--	--

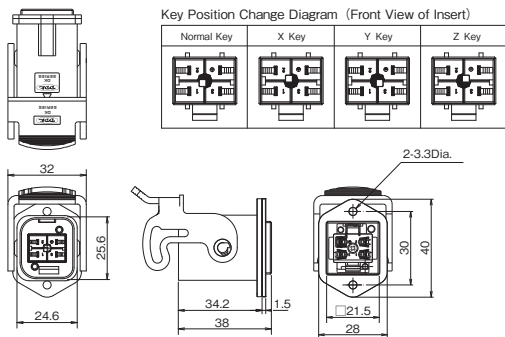

Tab Housing

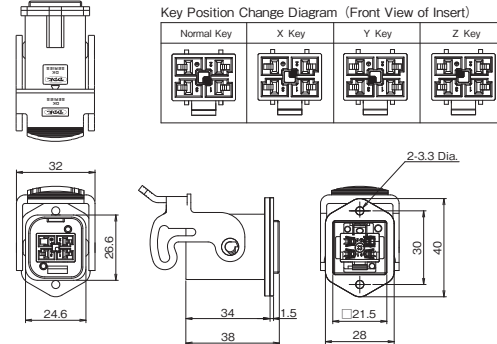

Receptacle Housing

© Specifications and/or dimensions in this catalogue are subject to change without notice.
 Your catalogue checking the latest specifications with our drawings would be highly appreciated.

▶ Crimp Contacts

DK-3 Contact

【Contact】

Applicable Cable Size		Insulation O.D. (mm)	Contact Size	Package Style	Part Number		Contact Quantity (pcs)
AWG	mm ²				Receptacle Contact	Tab Contact	
28	0.08	0.8 ~ 1.2	S	Reel	DK-3RECSST1-4000	DK-3TABSST1-4000	4000
26	0.12			Bag	DK-3RECSLP1-100	DK-3TABSLP1-100	100
24	0.20	1.0 ~ 1.4	M	Reel	DK-3RECMST1-3500	DK-3TABMST1-3500	3500
22	0.30	1.2 ~ 1.6		Bag	DK-3RECMLP1-100	DK-3TABMLP1-100	100
20	0.50			1.7 ~ 2.6	Reel	DK-3RECLST1-3000	DK-3TABLST1-3000
18	0.85	1.8 ~ 2.8		Bag	DK-3RECLLP1-100	DK-3TABLLP1-100	100
16	1.25		2.2 ~ 2.8	Reel	DK-3REC2LST1-3000	DK-3TAB2LST1-3000	3000
16	1.25	2.2 ~ 2.8	2L	Reel	DK-3REC2LLP1-100	DK-3TAB2LLP1-100	100
				Bag	DK-3REC2LLP1-100	DK-3TAB2LLP1-100	100

【Premating Contact】

Applicable Cable Size		Insulation O.D. (mm)	Contact Size	Package Style	Part Number		Contact Quantity (pcs)
AWG	mm ²				Receptacle Contact	Tab Contact	
24	0.20	1.2 ~ 1.6	M	Bag	DK-3RECMLP1-E-100	DK-3TABMLP1-E-100	100
22	0.30						
20	0.50	1.7 ~ 2.6	L	Bag	DK-3RECLLP1-E-100	DK-3TABLLP1-E-100	100
20	0.50	1.8 ~ 2.8					
18	0.85						
16	1.25						
16	1.25	2.2 ~ 2.8	2L	Bag	DK-3REC2LLP1-E-100	DK-3TAB2LLP1-E-100	100

DK-3RECSST1-E-4000

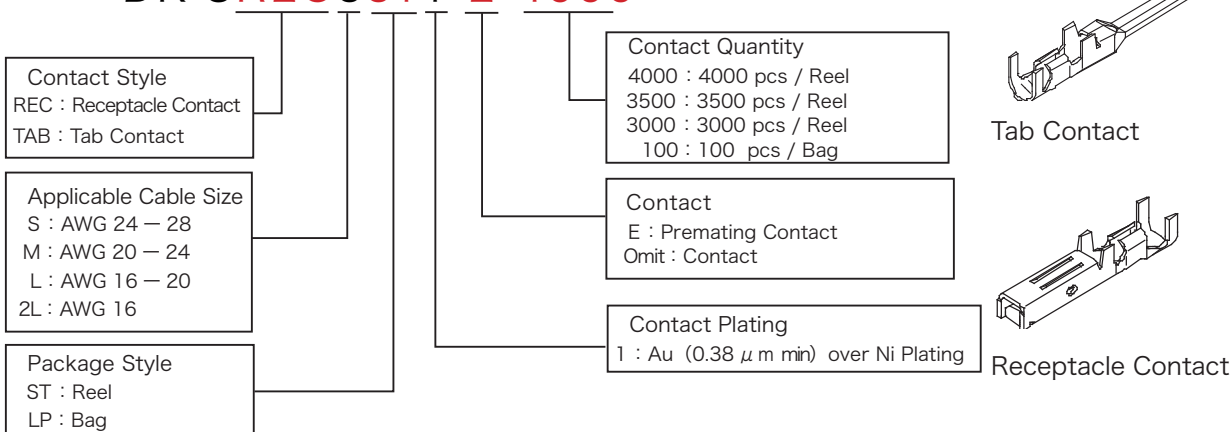

Keying Plug [Prevent Misinsertion Key]

◆ Used to prevent misinsertion.

Part Number : DK-3KP

MOQ : 100 pcs

