

Features

- 1 inch² footprint for the tiniest 3 watt module
- Standby mode optimized (Ecodesign Lot 6)
- No load power consumption <150mW
- Operating temperature range: -40°C to +80°C
- Household IEC/EN60335
- EMC compliance without external components

Regulated Converter



RAC03-K

3 Watt Single Output



Description

The RAC03-K series are the smallest 3 watt solution on the market. In a compact 1in² footprint, these modules deliver an output power of 3 watts from -40°C to 60°C and 2 watts up to 80°C. Despite such a high power density and small footprint, the RAC03-K series is a complete solution supporting Ecodesign Lot 6 standby mode operation for worldwide applications in automation, industry 4.0, IoT, household, and home automation. With an input voltage range from 85 to 264VAC and international safety certifications for industrial, domestic, ITE, and household applications, these are some of the most versatile power modules on the market. Due to their reinforced class II installation rating and their significantly wide margin to class B emissions compliance without external components, these are the easiest to use modular power solutions in the industry.

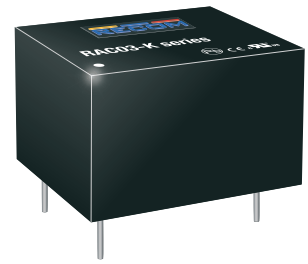

Selection Guide

Part Number	Input Voltage Range [VAC]	Output Voltage [VDC]	Output Current [mA]	Efficiency typ ⁽¹⁾ [%]	Max. Capacitive Load [μF]
RAC03-3.3SK	85-264	3.3	900	69	10000
RAC03-05SK	85-264	5	600	74	10000
RAC03-12SK	85-264	12	250	78	2200
RAC03-15SK	85-264	15	200	75	1800
RAC03-18SK	85-264	18	170	78	1500
RAC03-24SK	85-264	24	125	77	680

Notes:

Note1: Efficiency is tested at 25°C with constant resistive load and 230VAC

UL/IEC/EN62368-1 certified
 CAN/CSA C22.2 No. 62368-1-14 certified
 IEC/EN60335-1 certified
 EN55032/EN55024 compliant
 EN55014-1 /-2 compliant
 IEC/EN61204-3 compliant
 FCC 47 Part 15
 CB Report

Model Numbering



Ordering Examples

RAC03-05SK = 5Vout Single THT
 RAC03-12SK = 12Vout Single THT

Specifications (measured @ Ta= 25°C, nom. Vin, full load and after warm-up unless otherwise stated)

BASIC CHARACTERISTICS

Parameter	Condition	Min.	Typ.	Max.
Internal Input Filter				Pi type
Input Voltage Range ^(2,3)	nom. Vin = 230VAC	85VAC 120VDC	230VAC	264VAC 370VDC
Input Current	115VAC 230VAC			80mA 40mA
Inrush Current	cold start at +25°C	115VAC 230VAC		10A 20A
No load Power Consumption	230VAC		100mW	150mW
ErP Standby Mode Conformity (Output Load Capability)	Input Power= 0.5W 1W			0.3W 0.7W
Input Frequency Range	AC Input	47Hz		63Hz
Minimum Load		0%		
Power Factor	115VAC 230VAC	0.5 0.4		
Start-up Time			20ms	
Rise Time			15ms	
Hold-up Time	115VAC 230VAC		15ms 80ms	
Internal Operating Frequency	100% load at nominal Vin			130kHz
Output Ripple and Noise ⁽⁴⁾	20MHz BW	3.3Vout, 5Vout all others		60mVp-p 1% of Vout nom.

Notes:

- Note2: The products were submitted for safety files at AC-Input operation
- Note3: Refer to **"Line Derating"**
- Note4: Measured with a 0.1µF MLCC & 10µF E-cap in parallel across output. (low ESR)

Efficiency vs. Load

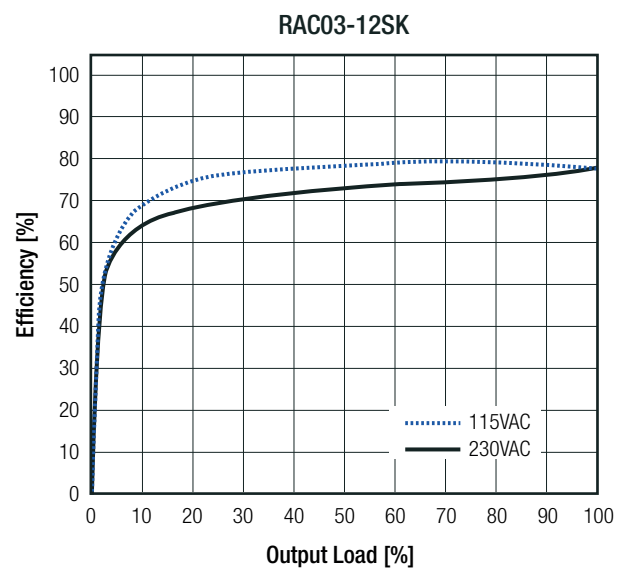
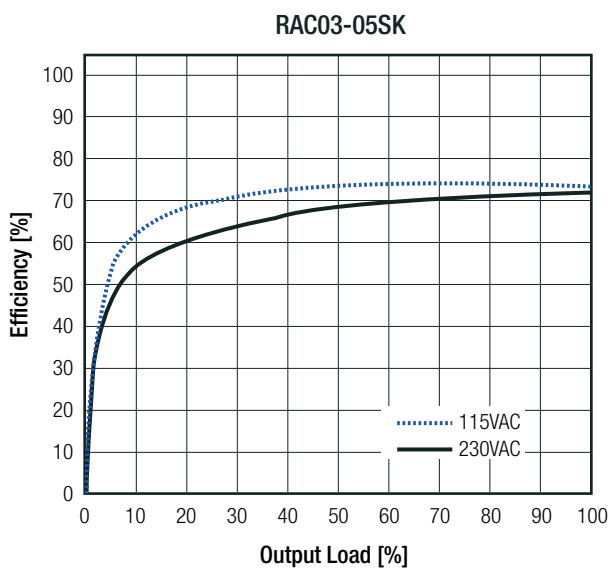

continued on next page

Specifications (measured @ Ta= 25°C, nom. Vin, full load and after warm-up unless otherwise stated)

Efficiency vs. Load

RAC03-18SK

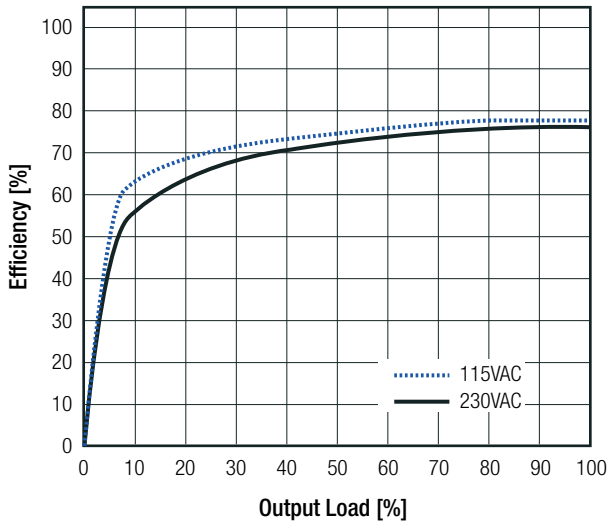

RAC03-24SK

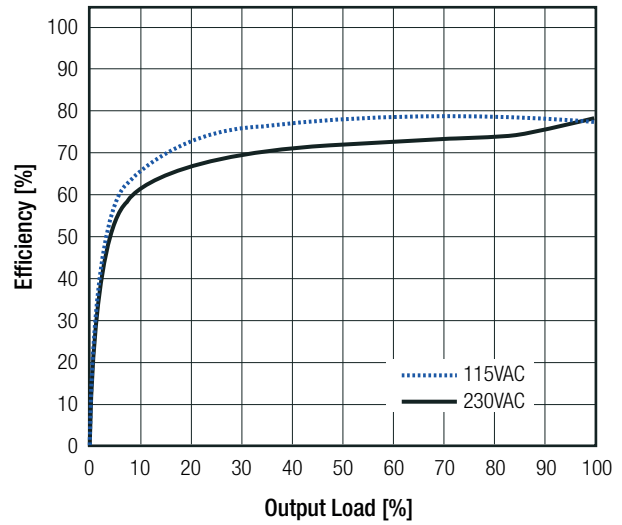

REGULATIONS

Parameter	Condition	Value
Output Accuracy		±3.0% typ.
Line Regulation	low line to high line, full load	±2.5% typ.
Load Regulation	10% to 100% load	2.5% typ.
Transient Response	25% load step change recovery time	4.0% max. 500µs typ.

Deviation vs. Load

RAC03-05SK

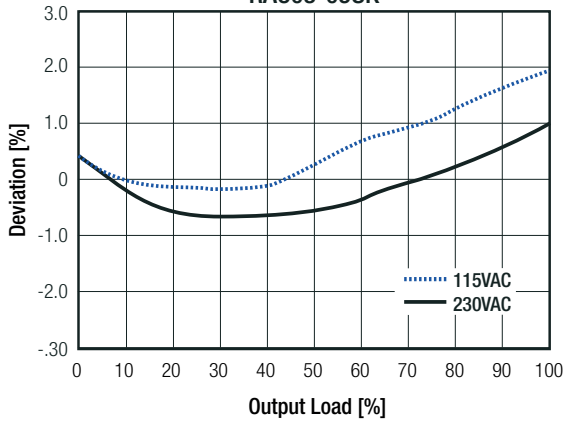

RAC03-12SK

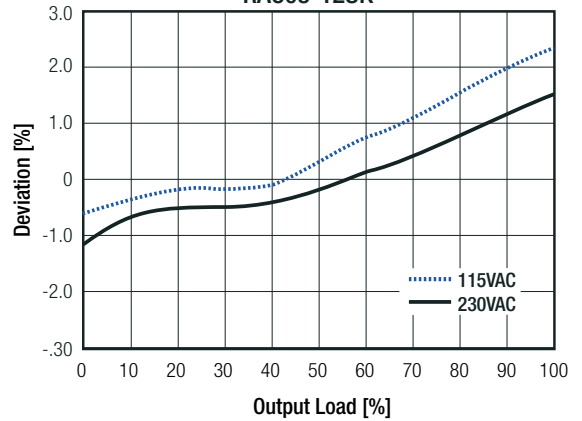

RAC03-18SK

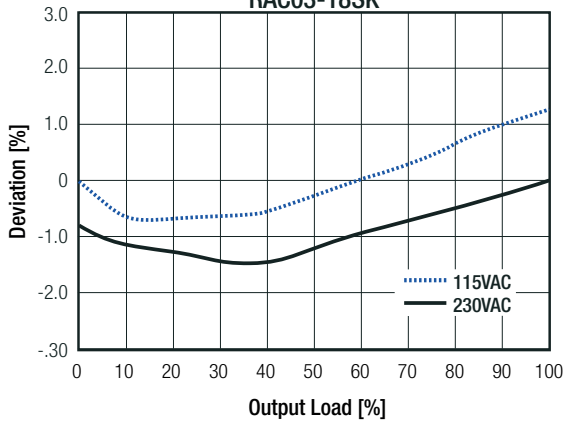

RAC03-24SK

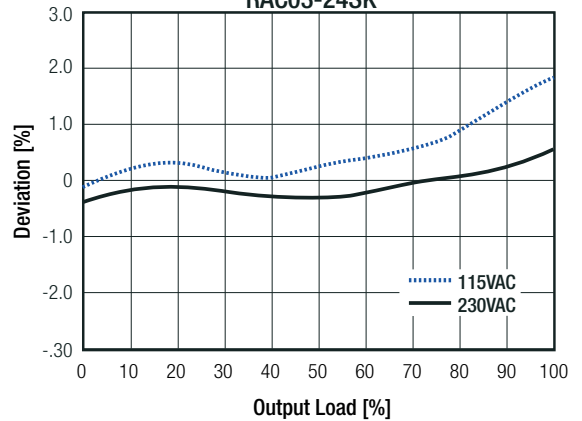

Specifications (measured @ Ta= 25°C, nom. Vin, full load and after warm-up unless otherwise stated)

PROTECTIONS

Parameter	Type		Value
Input Fuse ⁽⁵⁾	internal		fusible resistor
Short Circuit Protection (SCP)	below 100mΩ		Hiccup Mode, auto recovery
Over Voltage Category (OVC)			OVCII
Over Current Protection (OCP)			Hiccup Mode, auto recovery
Class of Equipment			Class II
Isolation Voltage (safety certified) ⁽⁶⁾	I/P to O/P	1 minute	3kVAC
Isolation Resistance	Viso= 500VDC		1GΩ min.
Isolation Capacitance	I/P to O/P	100kHz, 0.1V	100pF max.
Insulation Grade			reinforced
Leakage Current			0.25mA max.

Notes:

Note5: Refer to local safety regulations if input over-current protection is also required. Recommended fuse: slow blow type

Note6: For repeat Hi-Pot testing, reduce the time and/or the test voltage

ENVIRONMENTAL

Parameter	Condition		Value
Operating Temperature Range	@ natural convection 0.1m/s	full load refer to "Derating Graph"	-25°C to +60°C -40°C to +80°C
Maximum Case Temperature	230VAC		+95°C
Temperature Coefficient			±0.05%/K
Operating Altitude	according to 62368-1 (60335-1)		5000m (6000m)
Operating Humidity			20% to 90% RH max.
Pollution Degree			PD2
Vibration	according to MIL-STD-202G		10-500kHz, 2G 10min./1cycle, period 60 min. each along x, y, z
MTBF	according to MIL-HDBK-217F, G.B.	+25°C	>450 x 10 ³ hours
Design Lifetime	230VAC/60Hz and full load	+25°C	>40 x 10 ³ hours

Derating Graph

(@ Chamber and natural convection 0.1 m/s)

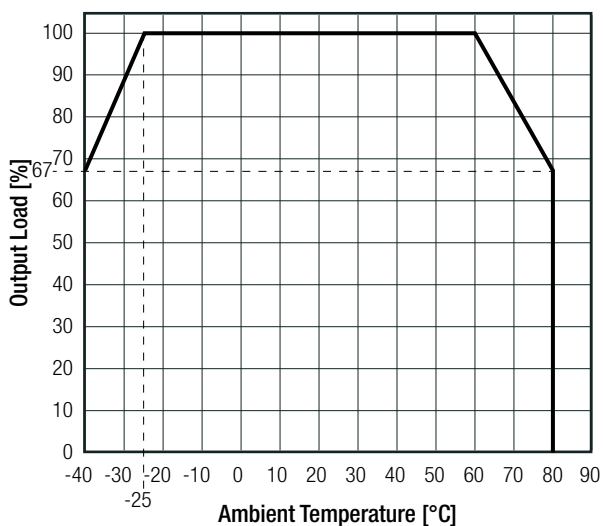

Line Derating

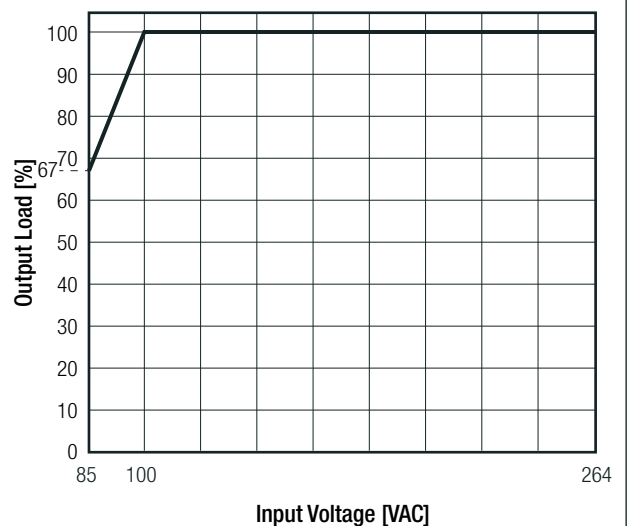

Specifications (measured @ Ta= 25°C, nom. Vin, full load and after warm-up unless otherwise stated)

SAFETY AND CERTIFICATIONS (DESIGNED TO MEET)		
Certificate Type	Report Number	Standard
Audio/video, information and communication technology equipment - Safety requirements	E224736	UL62368-1:2014, 2nd Edition CAN/CSA C22.2 No. 62368-1-14, 2nd Edition
Audio/video, information and communication technology equipment - Safety requirements (CB Scheme)	E491408-A6013	IEC62368-1:2014, 2nd Edition
Audio/video, information and communication technology equipment - Safety requirements		EN62368-1:2014 + A11:2017
Household and similar electrical appliances - Safety - Part 1: General requirements (LVD)	LCS190408025CS	IEC60335-1:2010 + C1:2016, 5th Edition EN60335-1:2012 + A13:2017
Measurement methods for electromagnetic fields of household appliances and similar apparatus with regard to human exposure		EN62233:2008
Safety of power transformers, power supplies, reactors and similar products for supply voltages up to 1100 V (CB Scheme)	50237373 001	IEC61558-1:2005 2nd Edition + A1:2009
Safety of power transformers, power supplies, reactors and similar products for supply voltages up to 1100 V		EN61558-1:2005 + A1:2009
Safety of transformers, reactors, power supply units and similar products for supply voltages up to 1100 V Part 2-16: Particular requirements and tests for switch mode power supply units and transformers for switch mode power supply units (CB Scheme)		IEC61558-2-16:2009 1st Edition + A1:2013
Safety of transformers, reactors, power supply units and similar products for supply voltages up to 1100 V Part 2-16: Particular requirements and tests for switch mode power supply units and transformers for switch mode power supply units		EN61558-2-16:2009 + A1:2013
RoHS2		RoHS-2011/65/EU + AM-2015/863

EMC Compliance	Condition	Standard / Criterion
Low voltage power supplies, d.c. output - Part 3: Electromagnetic compatibility	LCS190408054BE	IEC/EN61204-3:2008, Class B
Electromagnetic compatibility of multimedia equipment - Emission requirements ⁽⁷⁾		EN55032:2015, Class B
Information technology equipment - Immunity characteristics - Limits and methods of measurement		EN55024:2010 + A1:2015
Electromagnetic compatibility - Requirements for household appliances, electric tools and similar apparatus - Part 1: Emission ⁽⁷⁾		EN55014-1:2006 + A2:2011
Electromagnetic compatibility - Requirements for household appliances, electric tools and similar apparatus - Part 2: Immunity		EN55014-2:2015
ESD Electrostatic discharge immunity test	Air: ±2, 4, 8kV Contact: ±2, 4kV	EN61000-4-2:2009, Criteria B
Radiated, radio-frequency, electromagnetic field immunity	10V/m (80-1000MHz) 3V/M (1.4-2GHz) 1V/m (2-2.7GHz)	EN61000-4-3:2006 + A1:2009, Criteria A
Fast Transient and Burst Immunity	AC & DC Port: ±2kV	EN61000-4-4:2012, Criteria B
Surge Immunity	AC Port: ±1kV DC Port: ±0.5kV	EN61000-4-5:2014 + A1:2017, Criteria B
Immunity to conducted disturbances, induced by radio-frequency fields	AC & DC Port: 10V	EN61000-4-6:2014, Criteria A
Power Magnetic Field Immunity	50Hz, 30A/m	EN61000-4-8:2010, Criteria A
Voltage Dips	100% and 60%	EN61000-4-11:2004 + A1:2017, Criteria B
	30% and 20%	EN61000-4-11:2004 + A1:2017, Criteria C
Voltage Interruptions	>95%	EN61000-4-11:2004 + A1:2017, Criteria C
Limits of Voltage Fluctuations & Flicker		EN61000-3-3:2013
Limitations on the amount of electromagnetic interference allowed from digital and electronic devices		FCC 47 Part 15 Subpart B

Notes:

Note7: If output is connected to GND, please contact RECOM tech support for further information

Specifications (measured @ Ta= 25°C, nom. Vin, full load and after warm-up unless otherwise stated)

DIMENSION AND PHYSICAL CHARACTERISTICS

Parameter	Type	Value
Material	case/baseplate potting PCB	black plastic, (UL94V-0) silicone, (UL94V-0) FR4, (UL94V-0)
Dimension (LxWxH)		28.5 x 23.5 x 17.9mm
Weight		20g typ.

Dimension Drawing (mm)

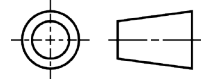
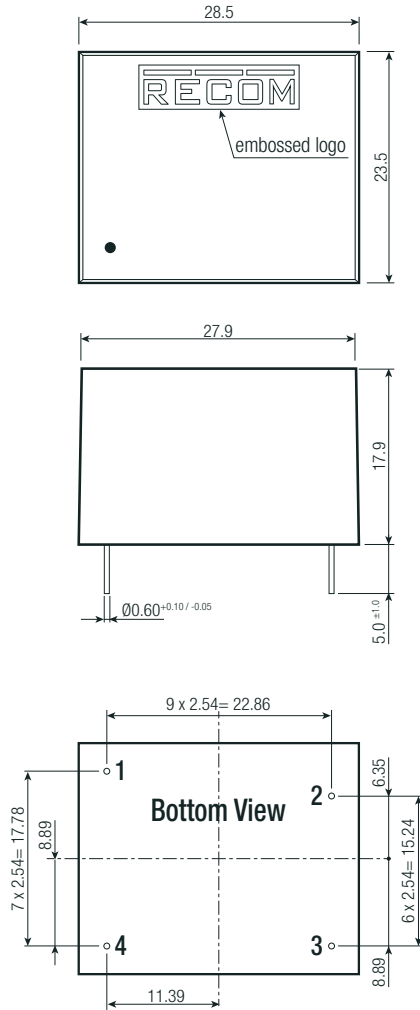

Pinning information

Pin #	Single
1	VAC in (L)
2	-Vout
3	+Vout
4	VAC in (N)

NC= no connection
Tolerance: xx.x= ±0.5mm
xx.xx= ±0.3mm

Recommended Footprint Details

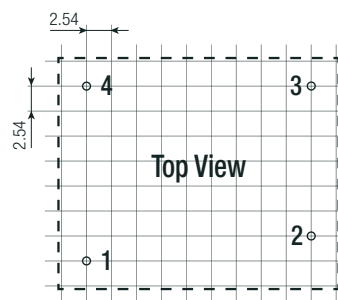

PACKAGING INFORMATION

Parameter	Type	Value
Packaging Dimension (LxWxH)	tube	486.8 x 30.5 x 27.6mm
Packaging Quantity		18pcs
Storage Temperature Range		-40°C to +85°C
Storage Humidity	non condensing	20% to 90% RH max.

The product information and specifications may be subject to changes even without prior written notice. The product has been designed for various applications; its suitability lies in the responsibility of each customer. The products are not authorized for use in safety-critical applications without RECOM's explicit written consent. A safety-critical application is an application where a failure may reasonably be expected to endanger or cause loss of life, inflict bodily harm or damage property. The applicant shall indemnify and hold harmless RECOM, its affiliated companies and its representatives against any damage claims in connection with the unauthorized use of RECOM products in such safety-critical applications.