

MICROWAVE LOW NOISE AMPLIFIER
NPN SILICON EPITAXIAL TRANSISTOR

FEATURES

- Low Voltage Operation, Low Phase Distortion
- Low Noise
 $NF = 1.5 \text{ dB TYP. @ } V_{CE} = 3 \text{ V, } I_c = 7 \text{ mA, } f = 2 \text{ GHz}$
 $NF = 1.7 \text{ dB TYP. @ } V_{CE} = 1 \text{ V, } I_c = 3 \text{ mA, } f = 2 \text{ GHz}$
- Large Absolute Maximum Collector Current
 $I_c = 100 \text{ mA}$
- 4-Pin Compact Mini Mold Package

ORDERING INFORMATION

PART NUMBER	QUANTITY	PACKING STYLE
2SC5194-T1	3 Kpcs/Reel	Embossed tape 8 mm wide. Pin 3 (Base), Pin 4 (Emitter) face to perforation side of the tape.
2SC5194-T2	3 Kpcs/Reel	Embossed tape 8 mm wide. Pin 1 (Collector), Pin 2 (Emitter) face to perforation side of the tape.

Remark If you require an evaluation sample, please contact an NEC Sales Representative. (Unit sample quantity is 50 pcs.)

ABSOLUTE MAXIMUM RATINGS ($T_A = 25 \text{ }^\circ\text{C}$)

PARAMETER	SYMBOL	RATING	UNIT
Collector to Base Voltage	V_{CBO}	9	V
Collector to Emitter Voltage	V_{CEO}	6	V
Emitter to Base Voltage	V_{EBO}	2	V
Collector Current	I_c	100	mA
Total Power Dissipation	P_T	150	mW
Junction Temperature	T_j	150	$^\circ\text{C}$
Storage Temperature	T_{stg}	-65 to +150	$^\circ\text{C}$

PACKAGE DRAWINGS

(Unit: mm)

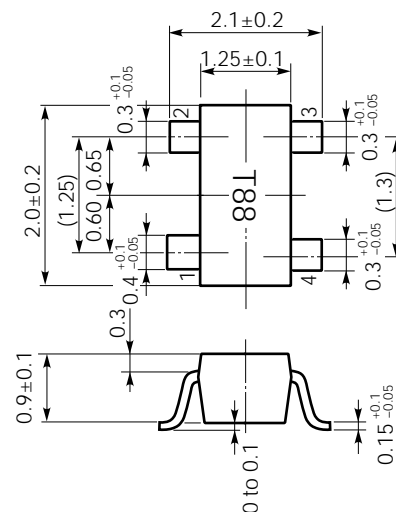

PIN CONNECTIONS

1. Collector
2. Emitter
3. Base
4. Emitter

This device uses radio frequency technology. Take due precautions to protect it from excessive input levels such as static electricity.

ELECTRICAL CHARACTERISTICS (T_A = 25 °C)

PARAMETER	SYMBOL	CONDITION	MIN.	TYP.	MAX.	UNIT
Collector Cutoff Current	I _{CBO}	V _{CB} = 5 V, I _E = 0			100	nA
Emitter Cutoff Current	I _{EBO}	V _{EB} = 1 V, I _C = 0			100	nA
DC Current Gain	h _{FE}	V _{CE} = 1 V, I _C = 3 mA ^{Note 1}	80		160	
Insertion Power Gain (1)	S _{21e} ²	V _{CE} = 1 V, I _C = 3 mA, f = 2.0 GHz	3.0	4.0		dB
Insertion Power Gain (2)	S _{21e} ²	V _{CE} = 3 V, I _C = 20 mA, f = 2.0 GHz		8.5		dB
Noise Figure (1)	NF	V _{CE} = 1 V, I _C = 3 mA, f = 2.0 GHz		1.7	2.5	dB
Noise Figure (2)	NF	V _{CE} = 3 V, I _C = 7 mA, f = 2.0 GHz		1.5		dB
Gain Bandwidth Product (1)	f _T	V _{CE} = 1 V, I _C = 3 mA, f = 2.0 GHz	4	5		GHz
Gain Bandwidth Product (2)	f _T	V _{CE} = 3 V, I _C = 20 mA, f = 2.0 GHz		10		GHz
Collector Capacitance	C _{re}	V _{CB} = 1 V, I _E = 0, f = 1.0 MHz ^{Note 2}		0.65	0.8	pF

Notes 1. Pulse Measurement: PW ≤ 350 μs, Duty cycle ≤ 2 %, Pulsed

2. Measured with 3-pin bridge, emitter and case should be connected to guard pin of bridge.

h_{FE} Classification

Rank	FB
Marking	T88
h _{FE}	80 to 160

TYPICAL CHARACTERISTICS (T_A = 25 °C)

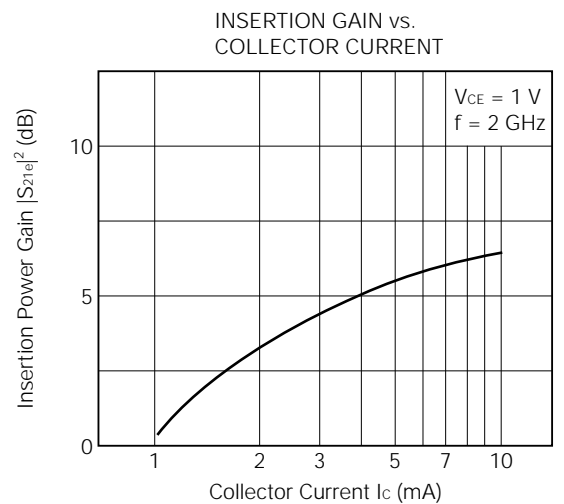
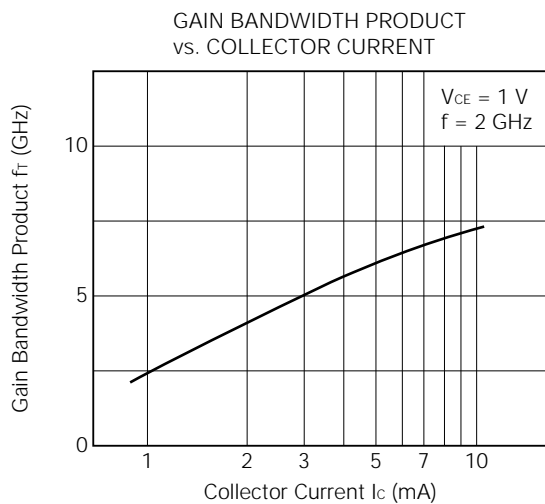
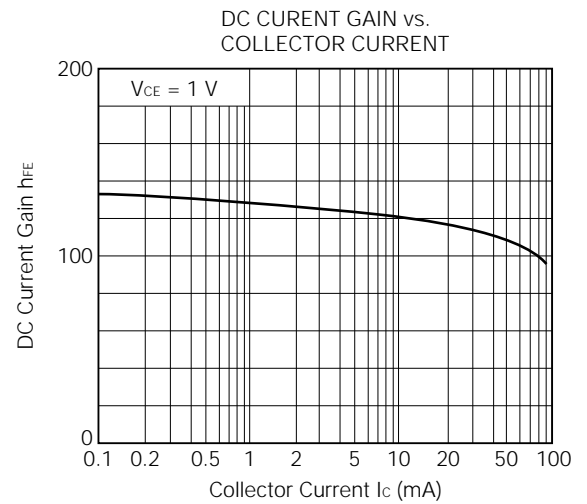
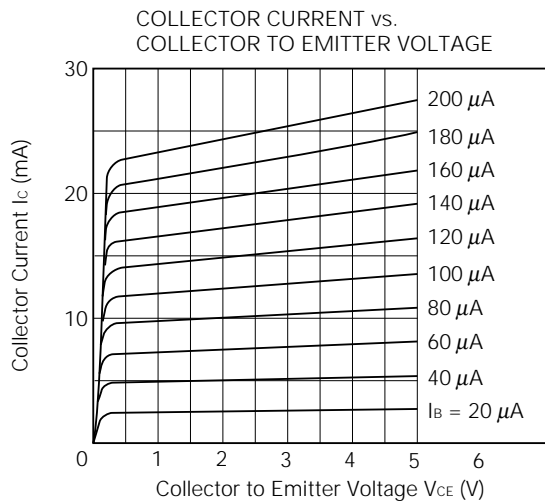
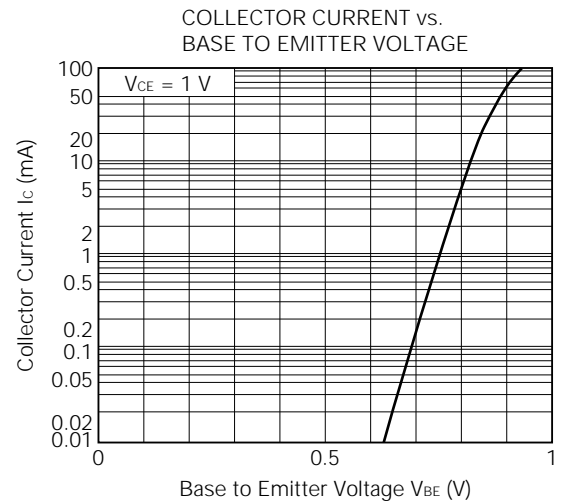
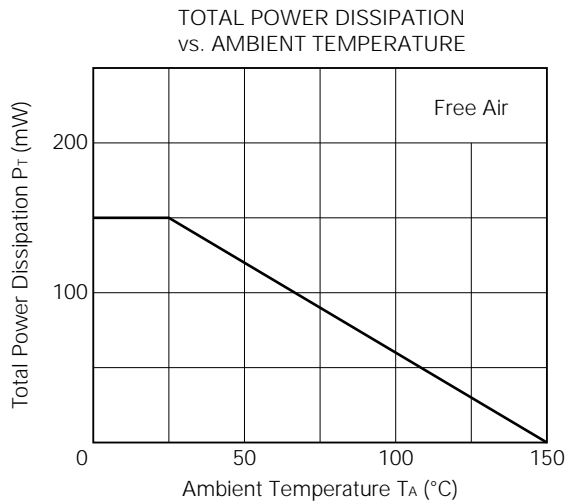

NOISE FIGURE vs. COLLECTOR CURRENT

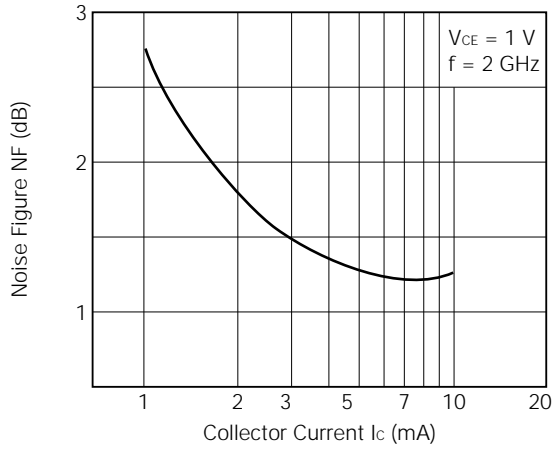

MAXIMUM AVAILABLE GAIN/INSERTION POWER GAIN vs. FREQUENCY

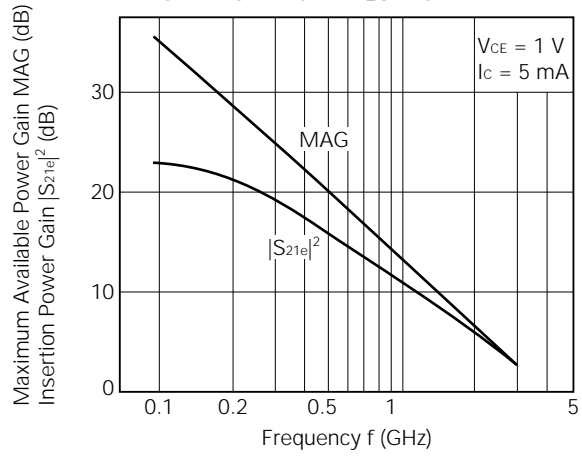

FEED-BACK CAPACITANCE vs. COLLECTOR TO BASE VOLTAGE

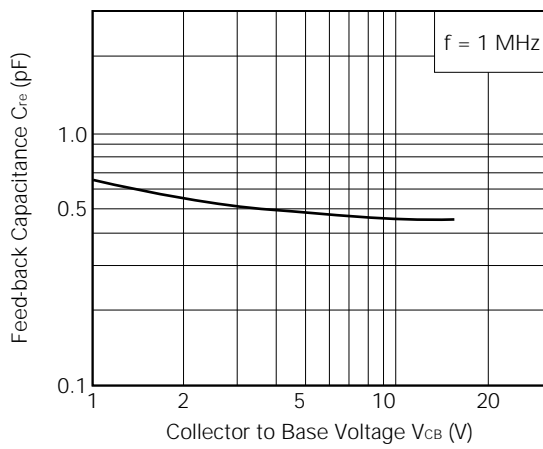

NOISE FIGURE vs. FREQUENCY

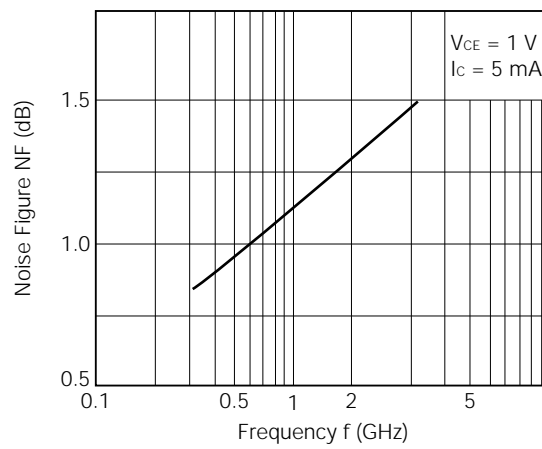

S-PARAMETERS

$V_{CE} = 1\text{ V}$, $I_c = 1\text{ mA}$, $Z_o = 50\ \Omega$

FREQUENCY (MHz)	S11		S21		S12		S22	
	MAG	ANG	MAG	ANG	MAG	ANG	MAG	ANG
100.00	0.928	-16.3	3.658	168.7	0.038	60.6	0.989	-7.0
200.00	0.919	-37.0	3.382	153.6	0.090	61.9	0.951	-13.4
300.00	0.886	-55.2	3.197	139.2	0.127	55.8	0.880	-27.4
400.00	0.866	-66.8	3.000	129.5	0.156	50.4	0.855	-32.8
500.00	0.827	-80.9	2.765	120.4	0.177	42.2	0.809	-39.9
600.00	0.756	-91.7	2.466	112.4	0.191	36.2	0.755	-41.9
700.00	0.738	-103.5	2.213	104.5	0.202	30.2	0.711	-47.1
800.00	0.725	-114.5	2.018	98.1	0.208	26.4	0.646	-48.3
900.00	0.706	-122.8	1.863	90.7	0.211	22.7	0.619	-52.6
1000.00	0.699	-132.2	1.712	85.6	0.210	18.8	0.569	-55.1
1100.00	0.675	-138.2	1.333	80.2	0.208	13.7	0.562	-59.2
1200.00	0.699	-145.9	1.463	76.2	0.206	9.6	0.534	-63.8
1300.00	0.718	-153.8	1.309	71.7	0.208	5.8	0.515	-65.8
1400.00	0.740	-157.1	1.235	69.1	0.208	4.0	0.504	-69.7
1500.00	0.713	-163.0	1.209	59.1	0.212	2.4	0.504	-69.9
1600.00	0.680	-166.4	1.192	55.2	0.210	2.8	0.497	-74.1
1700.00	0.697	-171.6	1.131	51.9	0.202	2.1	0.483	-76.3
1800.00	0.669	-178.6	1.119	50.5	0.194	2.7	0.486	-79.9
1900.00	0.696	178.7	1.018	47.5	0.187	1.1	0.478	-84.3
2000.00	0.702	174.8	0.955	46.1	0.178	1.2	0.490	-86.1

$V_{CE} = 1\text{ V}$, $I_c = 3\text{ mA}$, $Z_o = 50\ \Omega$

FREQUENCY (MHz)	S11		S21		S12		S22	
	MAG	ANG	MAG	ANG	MAG	ANG	MAG	ANG
100.00	0.873	-29.6	9.700	161.1	0.040	54.3	0.949	-15.1
200.00	0.837	-59.1	8.346	142.1	0.084	52.9	0.850	-34.3
300.00	0.792	-82.4	7.422	126.2	0.110	46.2	0.730	-49.0
400.00	0.734	-98.8	6.092	115.4	0.125	40.4	0.643	-56.6
500.00	0.679	-114.6	5.149	107.5	0.131	35.0	0.558	-63.4
600.00	0.645	-126.9	4.519	101.8	0.137	32.0	0.500	-66.0
700.00	0.637	-137.1	3.994	95.0	0.142	28.7	0.451	-73.1
800.00	0.617	-147.5	3.563	89.3	0.143	27.4	0.395	-76.7
900.00	0.588	-153.9	3.142	84.4	0.143	26.4	0.354	-80.0
1000.00	0.600	-161.2	2.865	81.0	0.143	25.5	0.327	-83.7
1100.00	0.588	-168.1	2.535	77.1	0.143	23.5	0.321	-87.7
1200.00	0.619	-172.9	2.427	73.4	0.143	21.7	0.303	-93.3
1300.00	0.626	-178.8	2.222	69.4	0.145	20.3	0.280	-95.8
1400.00	0.639	-179.4	2.110	66.5	0.149	20.6	0.268	-100.0
1500.00	0.630	175.2	2.017	60.5	0.157	20.8	0.259	-100.4
1600.00	0.600	172.3	1.913	57.3	0.161	22.3	0.259	-103.1
1700.00	0.614	167.9	1.820	54.6	0.160	24.1	0.247	-109.6
1800.00	0.605	163.4	1.720	54.0	0.161	26.0	0.251	-112.4
1900.00	0.623	161.5	1.618	52.0	0.160	26.5	0.253	-116.8
2000.00	0.630	153.6	1.532	51.0	0.160	27.2	0.259	-117.9

V_{CE} = 1 V, I_c = 5 mA, Z_o = 50 Ω

FREQUENCY (MHz)	S11		S21		S12		S22	
	MAG	ANG	MAG	ANG	MAG	ANG	MAG	ANG
100.00	0.819	-39.2	14.097	155.3	0.039	48.7	0.919	-21.7
200.00	0.771	-74.7	11.500	134.1	0.076	46.3	0.770	-45.7
300.00	0.720	-100.5	9.255	118.0	0.095	41.9	0.629	-62.9
400.00	0.656	-118.2	7.530	107.7	0.104	37.8	0.523	-71.7
500.00	0.620	-132.7	6.220	101.6	0.108	35.5	0.437	-78.3
600.00	0.613	-144.3	5.425	96.6	0.113	34.2	0.389	-81.6
700.00	0.605	-153.0	4.738	90.2	0.117	32.3	0.355	-90.4
800.00	0.584	-162.3	4.170	85.3	0.118	32.5	0.300	-97.1
900.00	0.556	-167.5	3.639	81.4	0.120	33.0	0.272	-100.7
1000.00	0.575	-173.8	3.328	78.6	0.123	33.1	0.255	-104.6
1100.00	0.571	179.5	3.019	75.1	0.125	32.1	0.254	-108.6
1200.00	0.595	176.1	2.816	71.7	0.127	31.0	0.243	-115.5
1300.00	0.602	171.3	2.573	68.0	0.130	30.4	0.224	-119.7
1400.00	0.610	171.5	2.438	65.2	0.137	30.8	0.215	-124.6
1500.00	0.608	166.6	2.325	60.1	0.146	30.9	0.206	-126.6
1600.00	0.581	164.0	2.190	57.2	0.154	32.1	0.212	-131.2
1700.00	0.593	160.3	2.079	54.8	0.156	34.3	0.208	-137.1
1800.00	0.591	156.7	1.955	54.7	0.160	33.9	0.213	-139.2
1900.00	0.607	155.0	1.854	52.9	0.162	36.5	0.217	-142.7
2000.00	0.612	152.5	1.756	51.9	0.164	36.8	0.223	-143.1

V_{CE} = 1 V, I_c = 7 mA, Z_o = 50 Ω

FREQUENCY (MHz)	S11		S21		S12		S22	
	MAG	ANG	MAG	ANG	MAG	ANG	MAG	ANG
100.00	0.760	-48.6	17.471	149.2	0.041	37.3	0.895	-26.2
200.00	0.715	-89.0	13.639	127.7	0.068	43.5	0.698	-55.1
300.00	0.670	-115.6	10.708	111.9	0.084	40.2	0.557	-75.1
400.00	0.611	-133.3	8.433	102.5	0.089	38.0	0.444	-85.0
500.00	0.592	-145.8	6.875	97.6	0.093	37.8	0.362	-91.6
600.00	0.600	-156.1	6.003	93.1	0.099	38.0	0.324	-95.0
700.00	0.591	-163.6	5.196	87.0	0.103	36.6	0.308	-103.3
800.00	0.571	-172.1	4.523	82.7	0.105	37.6	0.265	-115.1
900.00	0.542	-176.6	3.938	79.6	0.109	38.9	0.239	-119.2
1000.00	0.566	178.0	3.610	77.1	0.114	39.6	0.227	-122.5
1100.00	0.567	171.5	3.288	73.7	0.117	38.8	0.232	-123.6
1200.00	0.588	169.1	3.034	70.5	0.121	37.8	0.228	-133.5
1300.00	0.589	165.1	2.773	67.2	0.125	37.4	0.212	-139.2
1400.00	0.597	165.6	2.639	64.5	0.133	37.7	0.206	-144.1
1500.00	0.600	161.1	2.515	59.7	0.143	37.6	0.201	-146.8
1600.00	0.573	158.7	2.557	57.0	0.153	38.2	0.211	-150.6
1700.00	0.586	155.6	2.231	54.9	0.157	40.2	0.213	-156.6
1800.00	0.584	152.3	2.101	55.1	0.162	41.8	0.218	-158.1
1900.00	0.599	151.0	1.996	53.3	0.166	42.1	0.221	-160.7
2000.00	0.604	148.6	1.895	52.3	0.169	42.1	0.228	-160.4

V_{CE} = 1 V, I_c = 10 mA, Z_o = 50 Ω

FREQUENCY (MHz)	S11		S21		S12		S22	
	MAG	ANG	MAG	ANG	MAG	ANG	MAG	ANG
100.00	0.704	-61.8	21.034	144.3	0.032	37.4	0.861	-33.6
200.00	0.669	-103.2	15.396	121.8	0.062	41.3	0.626	-64.9
300.00	0.633	-129.6	11.781	106.8	0.074	40.3	0.494	-85.9
400.00	0.583	-146.3	9.058	98.7	0.078	40.1	0.388	-97.2
500.00	0.579	-156.5	7.353	94.7	0.082	41.9	0.316	-104.9
600.00	0.596	-165.4	6.413	90.5	0.089	42.8	0.284	-108.8
700.00	0.584	-171.9	5.493	84.8	0.094	41.9	0.281	-118.8
800.00	0.563	-179.4	4.762	80.9	0.097	43.2	0.254	-130.0
900.00	0.536	176.8	4.149	78.4	0.102	45.0	0.232	-134.8
1000.00	0.562	172.0	3.816	75.9	0.110	45.4	0.221	-137.9
1100.00	0.565	166.1	3.460	72.8	0.114	44.7	0.228	-139.7
1200.00	0.584	164.3	3.185	69.7	0.118	43.7	0.231	-147.3
1300.00	0.583	160.7	2.916	66.6	0.124	43.2	0.218	-153.7
1400.00	0.589	161.6	2.782	64.0	0.133	43.2	0.215	-158.6
1500.00	0.595	157.3	2.638	59.5	0.144	42.7	0.213	-161.3
1600.00	0.569	155.1	2.468	56.9	0.154	42.9	0.223	-164.1
1700.00	0.582	152.4	2.335	55.0	0.159	44.7	0.230	-169.5
1800.00	0.582	149.6	2.203	55.3	0.166	45.9	0.237	-170.5
1900.00	0.597	148.2	2.090	53.5	0.169	46.2	0.238	-172.9
2000.00	0.600	145.8	1.985	52.7	0.174	43.9	0.244	-172.1

V_{CE} = 3 V, I_c = 1 mA, Z_o = 50 Ω

FREQUENCY (MHz)	S11		S21		S12		S22	
	MAG	ANG	MAG	ANG	MAG	ANG	MAG	ANG
100.00	1.033	-16.8	3.626	168.0	0.024	37.6	0.992	-4.3
200.00	0.994	-32.7	3.276	158.4	0.066	62.7	0.970	-13.2
300.00	1.016	-48.6	3.320	146.3	0.102	59.1	0.924	-20.7
400.00	1.004	-62.9	3.208	134.2	0.127	51.4	0.897	-25.2
500.00	0.904	-77.0	2.864	125.7	0.138	43.4	0.860	-30.0
600.00	0.822	-84.6	2.593	120.7	0.149	39.9	0.838	-31.2
700.00	0.829	-96.7	2.423	112.7	0.165	33.3	0.808	-36.8
800.00	0.794	-109.8	2.202	104.9	0.167	27.6	0.733	-37.2
900.00	0.747	-118.0	2.010	98.0	0.166	24.7	0.711	-40.1
1000.00	0.736	-125.8	1.857	94.1	0.166	22.0	0.667	-41.3
1100.00	0.718	-131.9	1.682	88.6	0.167	16.8	0.664	-46.0
1200.00	0.732	-141.3	1.625	83.8	0.164	12.1	0.619	-50.1
1300.00	0.732	-149.9	1.437	79.9	0.164	8.7	0.605	-51.2
1400.00	0.747	-153.1	1.368	78.9	0.163	7.7	0.602	-54.6
1500.00	0.729	-158.6	1.335	68.3	0.168	6.1	0.603	-55.4
1600.00	0.691	-163.0	1.321	63.0	0.165	6.4	0.595	-58.9
1700.00	0.699	-168.3	1.231	59.8	0.157	6.1	0.577	-60.1
1800.00	0.660	-175.2	1.245	58.5	0.150	7.9	0.579	-63.0
1900.00	0.693	-178.0	1.130	55.9	0.147	6.9	0.564	-66.3
2000.00	0.700	177.4	1.062	54.1	0.139	7.0	0.574	-68.7

$V_{CE} = 3\text{ V}$, $I_c = 3\text{ mA}$, $Z_o = 50\ \Omega$

FREQUENCY (MHz)	S11		S21		S12		S22	
	MAG	ANG	MAG	ANG	MAG	ANG	MAG	ANG
100.00	0.940	-25.6	9.732	162.7	0.025	56.8	0.970	-10.1
200.00	0.892	-49.0	8.526	148.5	0.060	56.4	0.903	-23.7
300.00	0.873	-70.6	8.103	133.3	0.087	51.0	0.809	-36.0
400.00	0.804	-87.6	6.813	120.9	0.101	44.0	0.722	-42.0
500.00	0.713	-102.8	5.759	113.7	0.105	39.0	0.648	-45.7
600.00	0.662	-114.0	5.147	108.9	0.112	36.7	0.613	-46.6
700.00	0.654	-125.8	4.656	101.4	0.118	32.4	0.562	-53.1
800.00	0.621	-137.6	4.138	95.0	0.117	30.3	0.480	-53.9
900.00	0.579	-144.2	3.663	90.1	0.116	29.8	0.451	-55.0
1000.00	0.584	-151.7	3.332	87.1	0.117	29.3	0.421	-56.3
1100.00	0.571	-158.9	3.050	87.7	0.118	27.0	0.415	-60.6
1200.00	0.592	-165.5	2.866	78.7	0.117	25.1	0.383	-65.3
1300.00	0.596	-172.0	2.604	75.1	0.118	24.0	0.359	-65.6
1400.00	0.609	-173.0	2.478	72.9	0.121	24.6	0.351	-67.7
1500.00	0.599	-178.6	2.398	66.4	0.128	24.8	0.348	-68.1
1600.00	0.568	178.1	2.273	62.4	0.132	26.4	0.340	-71.9
1700.00	0.578	173.4	2.143	59.9	0.131	28.4	0.322	-75.5
1800.00	0.565	168.5	2.039	59.2	0.132	31.0	0.321	-76.0
1900.00	0.586	166.3	1.918	57.4	0.133	31.8	0.315	-79.6
2000.00	0.593	162.9	1.813	56.0	0.132	32.7	0.320	-81.5

$V_{CE} = 3\text{ V}$, $I_c = 5\text{ mA}$, $Z_o = 50\ \Omega$

FREQUENCY (MHz)	S11		S21		S12		S22	
	MAG	ANG	MAG	ANG	MAG	ANG	MAG	ANG
100.00	0.879	-31.8	14.413	158.3	0.028	34.2	0.965	-12.8
200.00	0.815	-61.2	12.159	141.3	0.057	49.3	0.840	-31.6
300.00	0.774	-85.7	10.485	125.0	0.078	46.9	0.719	-46.0
400.00	0.688	-104.0	8.723	113.5	0.086	42.3	0.604	-52.1
500.00	0.618	-119.0	7.234	107.4	0.088	39.4	0.523	-54.6
600.00	0.592	-130.9	6.423	102.7	0.094	38.7	0.491	-55.2
700.00	0.583	-141.7	3.688	95.7	0.098	35.7	0.445	-62.3
800.00	0.553	-152.3	4.996	90.3	0.098	35.5	0.368	-64.0
900.00	0.518	-157.8	4.380	86.4	0.100	36.5	0.338	-64.3
1000.00	0.530	-164.6	4.016	83.7	0.102	36.9	0.317	-65.4
1100.00	0.523	-172.1	3.672	79.7	0.104	35.6	0.314	-69.8
1200.00	0.541	-176.9	3.401	76.1	0.106	34.4	0.289	-75.3
1300.00	0.547	178.0	3.101	72.9	0.108	34.0	0.264	-75.9
1400.00	0.559	177.8	2.945	70.4	0.114	34.8	0.255	-77.6
1500.00	0.555	172.5	2.825	65.0	0.122	34.8	0.251	-78.1
1600.00	0.529	169.6	2.661	61.6	0.128	36.1	0.246	-82.5
1700.00	0.540	165.6	2.522	59.3	0.130	38.2	0.229	-85.3
1800.00	0.534	161.6	2.373	59.1	0.134	40.5	0.228	-87.8
1900.00	0.553	159.8	2.259	57.3	0.137	41.3	0.226	-91.5
2000.00	0.558	156.7	2.134	56.1	0.139	41.8	0.231	-93.5

V_{CE} = 3 V, I_c = 7 mA, Z_o = 50 Ω

FREQUENCY (MHz)	S11		S21		S12		S22	
	MAG	ANG	MAG	ANG	MAG	ANG	MAG	ANG
100.00	0.820	-38.9	17.998	153.7	0.023	51.2	0.949	-12.2
200.00	0.734	-72.7	14.931	134.9	0.054	48.6	0.780	-38.3
300.00	0.683	-98.8	12.431	118.7	0.069	44.5	0.636	-54.1
400.00	0.603	-117.4	10.006	108.2	0.075	42.4	0.315	-60.0
500.00	0.558	-131.7	8.204	102.9	0.077	41.9	0.433	-61.9
600.00	0.548	-143.3	7.226	98.4	0.083	42.4	0.403	-62.0
700.00	0.539	-152.7	6.334	92.0	0.086	40.5	0.367	-69.6
800.00	0.514	-162.3	5.531	87.3	0.088	41.1	0.298	-72.8
900.00	0.485	-167.3	4.834	84.1	0.091	42.6	0.268	-72.9
1000.00	0.501	-173.4	4.433	81.4	0.096	43.6	0.231	-73.7
1100.00	0.499	179.5	4.025	77.9	0.099	42.5	0.253	-78.1
1200.00	0.517	173.9	3.736	74.7	0.101	41.7	0.234	-84.9
1300.00	0.522	171.5	3.407	71.6	0.105	41.3	0.208	-86.2
1400.00	0.531	171.6	3.243	69.0	0.112	41.7	0.198	-88.1
1500.00	0.532	166.8	3.095	64.1	0.121	41.6	0.195	-88.8
1600.00	0.508	164.2	2.906	61.0	0.129	42.4	0.193	-94.0
1700.00	0.520	160.7	2.754	59.0	0.133	44.2	0.178	-98.4
1800.00	0.518	137.1	2.581	59.0	0.137	46.2	0.178	-101.1
1900.00	0.534	155.5	2.459	57.3	0.142	46.7	0.178	-104.8
2000.00	0.540	152.7	2.325	56.2	0.144	46.9	0.185	-106.6

V_{CE} = 3 V, I_c = 10 mA, Z_o = 50 Ω

FREQUENCY (MHz)	S11		S21		S12		S22	
	MAG	ANG	MAG	ANG	MAG	ANG	MAG	ANG
100.00	0.734	-47.2	22.178	149.7	0.023	32.6	0.923	-23.1
200.00	0.665	-84.6	17.574	129.1	0.050	44.4	0.709	-45.1
300.00	0.610	-111.6	13.993	113.3	0.061	44.3	0.560	-61.3
400.00	0.542	-129.9	10.962	104.0	0.065	44.4	0.440	-67.2
500.00	0.517	-142.8	8.974	97.4	0.069	45.9	0.361	-68.8
600.00	0.520	-153.6	7.824	93.1	0.075	46.7	0.334	-68.3
700.00	0.511	-161.7	6.777	89.3	0.080	45.6	0.308	-76.5
800.00	0.490	-170.3	5.897	85.0	0.082	46.7	0.248	-81.6
900.00	0.464	-174.8	5.143	82.3	0.087	48.5	0.218	-82.1
1000.00	0.482	179.6	4.722	79.8	0.092	49.0	0.204	-82.3
1100.00	0.484	173.0	4.312	76.5	0.096	48.2	0.209	-86.7
1200.00	0.502	170.3	3.969	73.5	0.100	47.5	0.196	-94.9
1300.00	0.506	166.4	3.626	70.6	0.104	47.0	0.172	-97.7
1400.00	0.514	166.9	3.453	68.0	0.112	47.1	0.161	-100.1
1500.00	0.517	162.4	3.285	63.4	0.122	46.5	0.139	-101.0
1600.00	0.495	160.1	3.083	60.7	0.131	46.7	0.161	-106.7
1700.00	0.308	157.0	2.914	58.7	0.136	48.4	0.150	-113.1
1800.00	0.307	153.8	2.738	58.8	0.141	50.0	0.150	-116.0
1900.00	0.523	152.4	2.603	57.2	0.146	30.3	0.152	-119.5
2000.00	0.527	149.7	2.459	56.1	0.150	50.3	0.159	-120.7

No part of this document may be copied or reproduced in any form or by any means without the prior written consent of NEC Corporation. NEC Corporation assumes no responsibility for any errors which may appear in this document.

NEC Corporation does not assume any liability for infringement of patents, copyrights or other intellectual property rights of third parties by or arising from use of a device described herein or any other liability arising from use of such device. No license, either express, implied or otherwise, is granted under any patents, copyrights or other intellectual property rights of NEC Corporation or others.

While NEC Corporation has been making continuous effort to enhance the reliability of its semiconductor devices, the possibility of defects cannot be eliminated entirely. To minimize risks of damage or injury to persons or property arising from a defect in an NEC semiconductor device, customer must incorporate sufficient safety measures in its design, such as redundancy, fire-containment, and anti-failure features.

NEC devices are classified into the following three quality grades:

"Standard", "Special", and "Specific". The Specific quality grade applies only to devices developed based on a customer designated "quality assurance program" for a specific application. The recommended applications of a device depend on its quality grade, as indicated below. Customers must check the quality grade of each device before using it in a particular application.

Standard: Computers, office equipment, communications equipment, test and measurement equipment, audio and visual equipment, home electronic appliances, machine tools, personal electronic equipment and industrial robots

Special: Transportation equipment (automobiles, trains, ships, etc.), traffic control systems, anti-disaster systems, anti-crime systems, safety equipment and medical equipment (not specifically designed for life support)

Specific: Aircrafts, aerospace equipment, submersible repeaters, nuclear reactor control systems, life support systems or medical equipment for life support, etc.

The quality grade of NEC devices in "Standard" unless otherwise specified in NEC's Data Sheets or Data Books. If customers intend to use NEC devices for applications other than those specified for Standard quality grade, they should contact NEC Sales Representative in advance.

Anti-radioactive design is not implemented in this product.