

Single IGBTMOD™ HVIGBT Module 1800 Amperes/1700 Volts

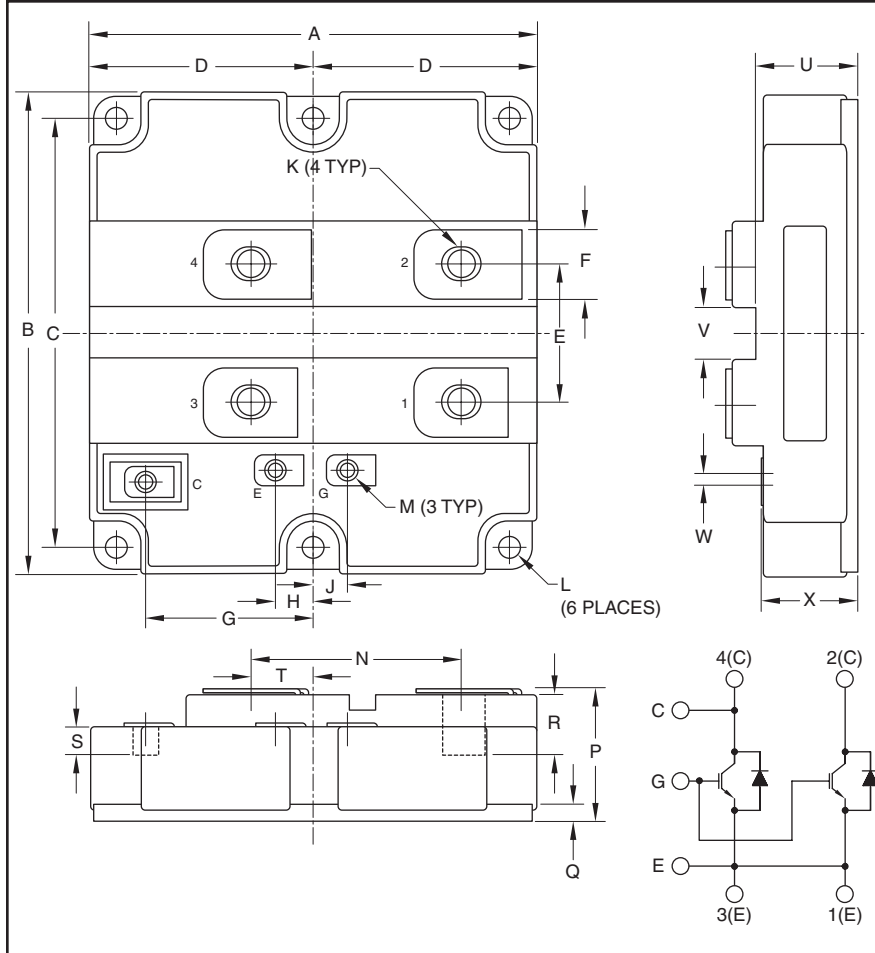

Outline Drawing and Circuit Diagram

Dimensions	Inches	Millimeters
A	5.19±0.02	130.0±0.5
B	5.51±0.02	140.0±0.5
C	4.88±0.01	124.0±0.25
D	2.24±0.01	57.0±0.25
E	1.57±0.008	40.0±0.2
F	0.79±0.004	20.0±0.1
G	1.92±0.008	48.8±0.2
H	0.42±0.008	10.65±0.2
J	0.41±0.008	10.35±0.2
K	M8 Metric	M8
L	0.28 Dia.	7.0 Dia.

Dimensions	Inches	Millimeters
M	M4 Metric	M4
N	2.42±0.012	61.5±0.3
P	1.50+0.04/-0.0	38.0+1.0/-0.0
Q	0.2±0.008	5.0±0.2
R	0.65 Min.	16.5 Min.
S	0.30 Min.	7.7 Min.
T	0.71±0.008	18.0±0.2
U	1.16±0.02	29.5±0.5
V	0.60±0.008	15.0±0.2
W	0.21±0.008	5.2±0.2
X	1.10+0.04/-0.0	28.0+1.0/-0.0



Description:

Powerex IGBTMOD™ Modules are designed for use in switching applications. Each module consists of one IGBT Transistor in a reverse-connected super-fast recovery free-wheel diode.

All components and interconnects are isolated from the heat sinking baseplate, offering simplified system assembly and thermal management.

Features:

- Low Drive Power
- Low $V_{CE(sat)}$
- Super-Fast Recovery Free-Wheel Diode
- Isolated Baseplate for Easy Heat Sinking

Applications:

- Traction
- Medium Voltage Drives
- High Voltage Power Supplies

Ordering Information:

Example: Select the complete part module number you desire from the table below -i.e. CM1800HC-34N is a 1700V (V_{CES}), 1800 Ampere Single IGBTMOD™ Power Module.

Type	Current Rating Amperes	V_{CES} Volts (x 50)
CM	1800	34



Powerex, Inc., 173 Pavilion Lane, Youngwood, Pennsylvania 15697 (724) 925-7272

CM1800HC-34N
Single IGBTMOD™ HVIGBT Module
1800 Amperes/1700 Volts

Absolute Maximum Ratings, $T_j = 25\text{ °C}$ unless otherwise specified

Ratings	Symbol	CM1800HC-34N	Units
Junction Temperature	T_j	-40 to 150	°C
Storage Temperature	T_{stg}	-40 to 125	°C
Operating Temperature	T_{opr}	-40 to 125	°C
Collector-Emitter Voltage ($V_{GE} = 0V$)	V_{CES}	1700	Volts
Gate-Emitter Voltage ($V_{CE} = 0V$)	V_{GES}	±20	Volts
Collector Current (DC, $T_c = 75\text{ °C}$)	I_C	1800	Amperes
Peak Collector Current (Pulse)	I_{CM}	3600*	Amperes
Emitter Current** ($T_c = 25\text{ °C}$)	I_E	1800	Amperes
Emitter Surge Current** (Pulse)	I_{EM}	3600*	Amperes
Maximum Collector Dissipation ($T_c = 25\text{ °C}$, IGBT Part, $T_{j(max)} \leq 125\text{ °C}$)	P_C	10000	Watts
Max. Mounting Torque M8 Main Terminal Screws	–	177	in-lb
Max. Mounting Torque M6 Mounting Screws	–	53	in-lb
Max. Mounting Torque M4 Auxiliary Terminal Screws	–	27	in-lb
Module Weight (Typical)	–	0.8	kg
Isolation Voltage (Charged Part to Baseplate, AC 60Hz 1 min.)	V_{iso}	4000	Volts
Maximum Turn-Off Switching Current ($V_{CC} \leq 1200V$, $V_{GE} = \pm 15V$, $T_j = 125\text{ °C}$)	–	3600	Amperes
Short Circuit Capability, Maximum Pulse Width ($V_{CC} \leq 1200V$, $V_{GE} = \pm 15V$, $T_j = 125\text{ °C}$)	–	10	µs
Maximum Reverse Recovery Instantaneous Power ($V_{CC} \leq 1200V$, $di_e/dt \leq 4200A/\mu s$, $T_j = 125\text{ °C}$)	–	750	kW

* Pulse width and repetition rate should be such that device junction temperature (T_j) does not exceed T_{oprmax} rating (125°C).

**Represents characteristics of the anti-parallel, emitter-to-collector free-wheel diode (FWD).

CM1800HC-34N
Single IGBTMOD™ HVIGBT Module
 1800 Amperes/1700 Volts

Static Electrical Characteristics, $T_j = 25\text{ }^\circ\text{C}$ unless otherwise specified

Characteristics	Symbol	Test Conditions	Min.	Typ.	Max.	Units
Collector-Cutoff Current	I_{CES}	$V_{CE} = V_{CES}, V_{GE} = 0V, T_j = 25^\circ\text{C}$	–	–	6.0	mA
		$V_{CE} = V_{CES}, V_{GE} = 0V, T_j = 125^\circ\text{C}$	–	4.5	12.0	mA
Gate-Emitter Threshold Voltage	$V_{GE(th)}$	$I_C = 180\text{mA}, V_{CE} = 10V$	6.0	7.0	8.0	Volts
Gate Leakage Current I_{GES}	$V_{GE} = V_{GES}, V_{CE} = 0V$	–	–	0.5	–	μA
Collector-Emitter Saturation Voltage	$V_{CE(sat)}$	$I_C = 1800\text{A}, V_{GE} = 15V, T_j = 25^\circ\text{C}$	–	2.15	2.8	Volts
		$I_C = 1800\text{A}, V_{GE} = 15V, T_j = 125^\circ\text{C}$	–	2.4	–	Volts
Input Capacitance	C_{ies}	$V_{CE} = 10V, V_{GE} = 0V,$	–	264	–	nF
Output Capacitance	C_{oes}	$f = 100\text{kHz},$	–	14.4	–	nF
Reverse Transfer Capacitance	C_{res}	$T_j = 25^\circ\text{C}$	–	4.2	–	nF
Total Gate Charge	Q_G	$V_{CC} = 850V, I_C = 1800\text{A}, V_{GE} = 15V$	–	10.2	–	μC
Emitter-Collector Voltage**	V_{EC}	$I_E = 1800\text{A}, V_{GE} = 0V, T_j = 25^\circ\text{C}$	–	2.6	3.3	Volts
		$I_E = 1800\text{A}, V_{GE} = 0V, T_j = 125^\circ\text{C}$	–	2.3	–	Volts
Turn-On Delay Time	$t_{d(on)}$	$V_{CC} = 850V, I_C = 1800\text{A},$	–	1.0	–	μs
Turn-On Rise Time	t_r	$V_{GE1} = -V_{GE2} = 15V, R_{G(on)} = 0.9\Omega,$	–	0.4	–	μs
Turn-On Switching Energy	E_{on}	Inductive Load	–	550	–	mJ/P
Turn-Off Delay Time	$t_{d(off)}$	$V_{CC} = 850V, I_C = 1800\text{A},$	–	1.2	–	μs
Turn-Off Fall Time	t_f	$V_{GE1} = -V_{GE2} = 15V, R_{G(off)} = 2.2\Omega,$	–	0.3	–	μs
Turn-Off Switching Energy	E_{off}	Inductive load	–	560	–	mJ/P
Reverse Recovery Time**	t_{rr}	$V_{CC} = 850V, I_E = 1800\text{A},$	–	720	–	Amperes
Reverse Recovery Time**	t_{rr}	$di_e/dt = -3700\text{A}/\mu\text{s},$	–	1.0	–	μs
Reverse Recovery Charge**	Q_{rr}	$T_j = 125^\circ\text{C},$	–	420	–	μC
Reverse Recovery Energy**	E_{rec}	Inductive Load	–	280	–	mJ/P

* Pulse width and repetition rate should be such that device junction temperature rise is negligible.

**Represents characteristics of the anti-parallel, emitter-to-collector free-wheel diode (FWDi).

Thermal Characteristics, $T_j = 25\text{ }^\circ\text{C}$ unless otherwise specified

Characteristics	Symbol	Test Conditions	Min.	Typ.	Max.	Units
Thermal Resistance, Junction to Case	$R_{th(j-c)}$ Q	Per IGBT	–	–	12.5	K/kW
Thermal Resistance, Junction to Case	$R_{th(j-c)}$ D	Per FWDi	–	–	28.0	K/kW
Contact Thermal Resistance, Case to Fin	$R_{th(c-f)}$	Per Module, Thermal Grease Applied	–	11.0	–	K/kW

Mechanical Characteristics, $T_j = 25\text{ }^\circ\text{C}$ unless otherwise specified

Characteristics	Symbol	Test Conditions	Min.	Typ.	Max.	Units
Comparative Tracking Index	CTI	–	600	–	–	–
Clearance	–	–	19.5	–	–	mm
Creepage Distance	–	–	32.0	–	–	mm
Internal Inductance	$L_{C-E(int)}$	–	–	16	–	nH
Internal Lead Resistance	$R_{C-E(int)}$	–	–	0.14	–	m Ω

CM1800HC-34N
Single IGBTMOD™ HVIGBT Module
 1800 Amperes/1700 Volts

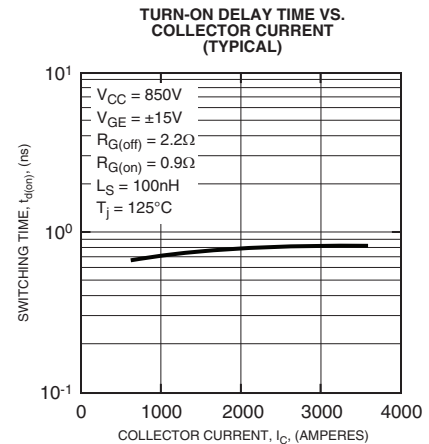
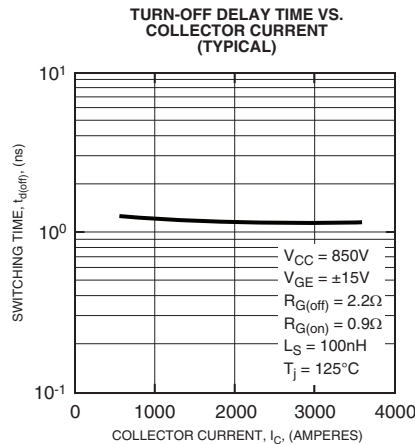
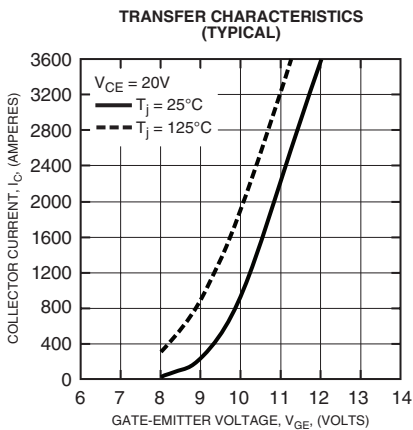
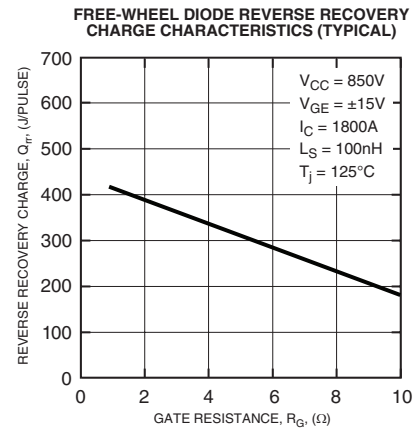
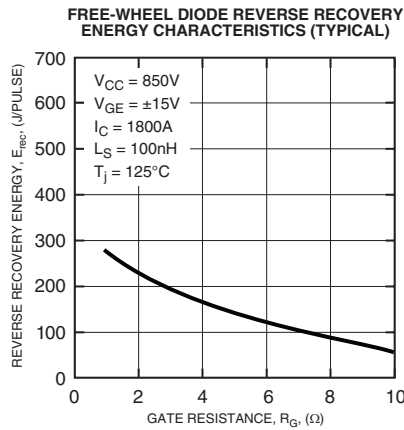
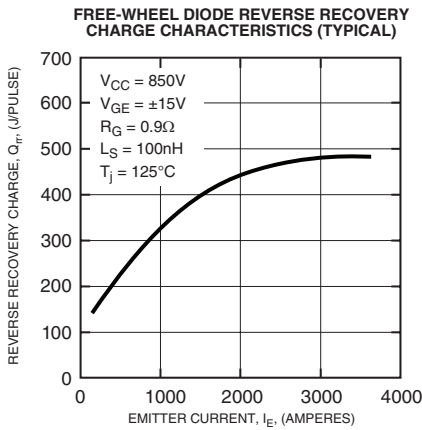
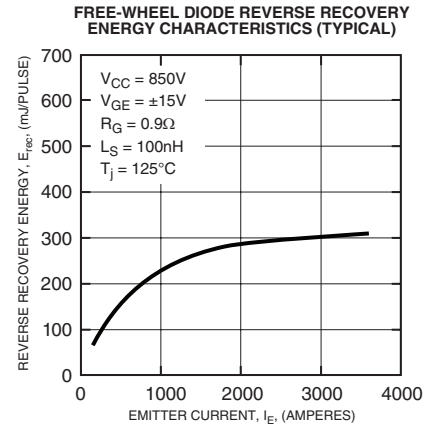
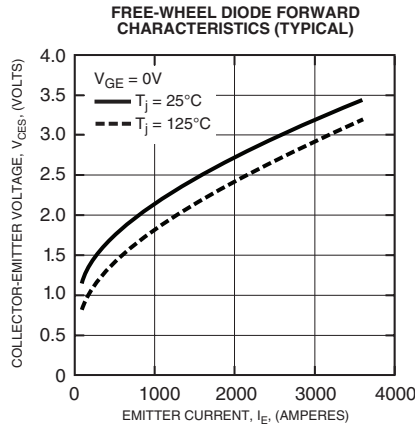
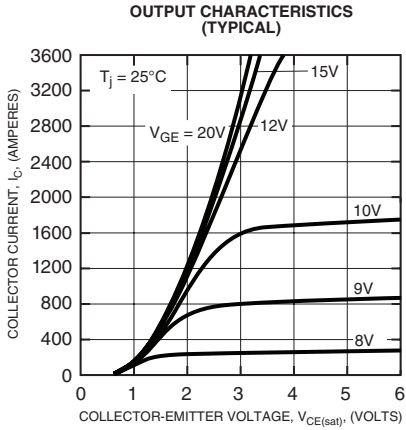

CM1800HC-34N
Single IGBTMOD™ HVIGBT Module
 1800 Amperes/1700 Volts

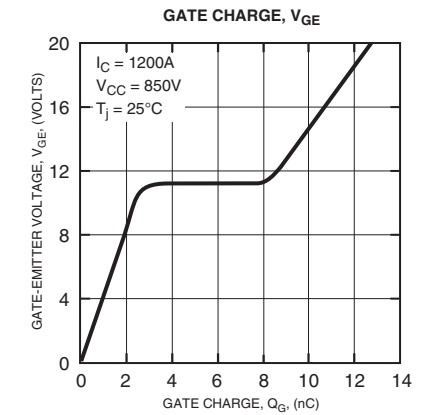
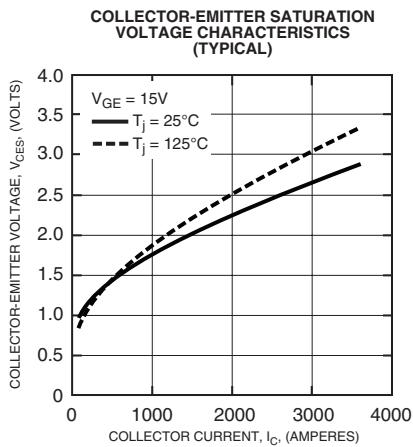
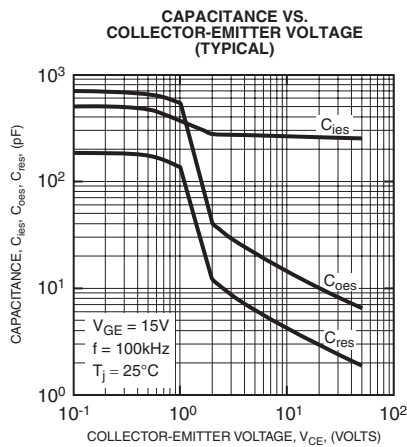
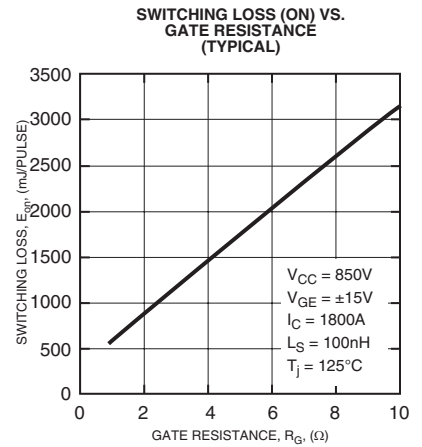
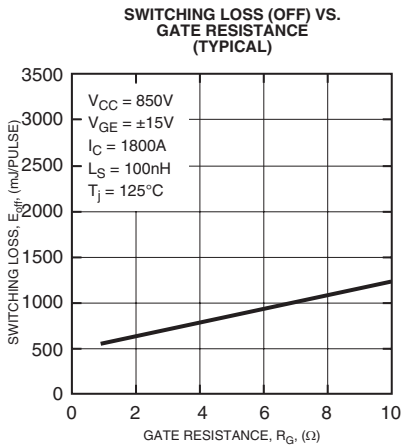
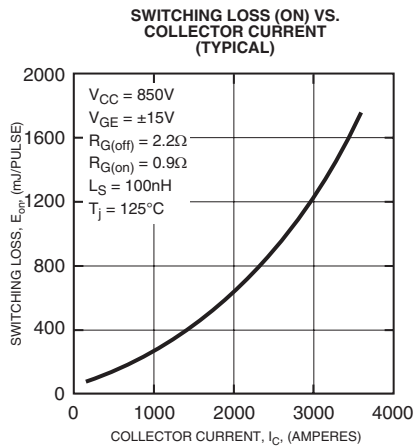
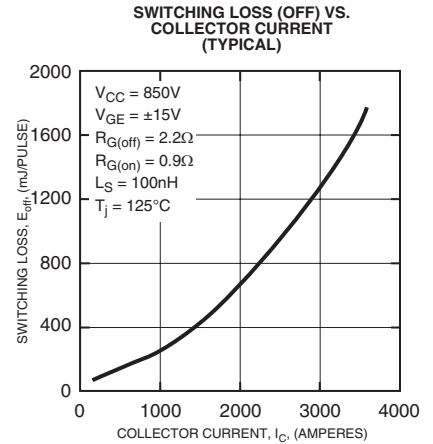
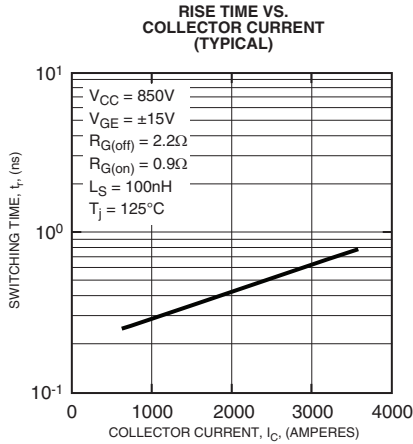
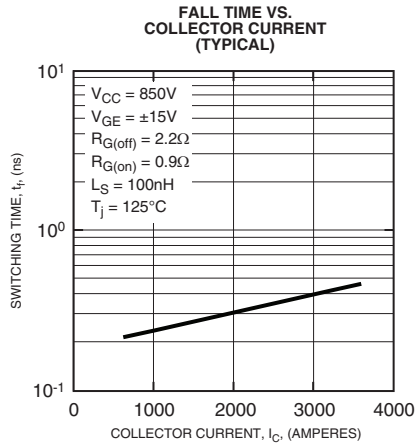

CM1800HC-34N
Single IGBTMOD™ HVIGBT Module
 1800 Amperes/1700 Volts

