



# High-Dynamic-Range, Direct Up-/Downconversion 750MHz to 1200MHz Quadrature Mod/Demod

MAX2021

## General Description

The MAX2021 low-noise, high-linearity, direct upconversion/downconversion quadrature modulator/demodulator is designed for RFID handheld and portal readers, as well as single and multicarrier 750MHz to 1200MHz GSM/EDGE, cdma2000®, WCDMA, and iDEN® base-station applications. Direct conversion architectures are advantageous since they significantly reduce transmitter or receiver cost, part count, and power consumption as compared to traditional IF-based double conversion systems.

In addition to offering excellent linearity and noise performance, the MAX2021 also yields a high level of component integration. This device includes two matched passive mixers for modulating or demodulating in-phase and quadrature signals, two LO mixer amplifier drivers, and an LO quadrature splitter. On-chip baluns are also integrated to allow for single-ended RF and LO connections. As an added feature, the baseband inputs have been matched to allow for direct interfacing to the transmit DAC, thereby eliminating the need for costly I/Q buffer amplifiers.

The MAX2021 operates from a single +5V supply. It is available in a compact 36-pin thin QFN package (6mm x 6mm) with an exposed paddle. Electrical performance is guaranteed over the extended -40°C to +85°C temperature range.

## Applications

RFID Handheld and Portal Readers  
Single and Multicarrier WCDMA 850 Base Stations  
Single and Multicarrier cdmaOne™ and cdma2000 Base Stations  
GSM 850/GSM 900 EDGE Base Stations  
Predistortion Transmitters and Receivers  
WiMAX Transmitters and Receivers  
Fixed Broadband Wireless Access  
Military Systems  
Microwave Links  
Digital and Spread-Spectrum Communication Systems  
Video-on-Demand (VOD) and DOCSIS Compliant Edge QAM Modulation  
Cable Modem Termination Systems (CMTS)

cdma2000 is a registered trademark of Telecommunications Industry Association.

iDEN is a registered trademark of Motorola, Inc.

cdmaOne is a trademark of CDMA Development Group.



## Features

- ◆ 750MHz to 1200MHz RF Frequency Range
- ◆ Scalable Power: External Current-Setting Resistors Provide Option for Operating Device in Reduced-Power/Reduced-Performance Mode
- ◆ 36-Pin, 6mm x 6mm TQFN Provides High Isolation in a Small Package

### Modulator Operation:

- ◆ Meets 4-Carrier WCDMA 65dBc ACLR
- ◆ +21dBm Typical OIP3
- ◆ +58dBm Typical OIP2
- ◆ +16.7dBm Typical OP<sub>1dB</sub>
- ◆ -32dBm Typical LO Leakage
- ◆ 43.5dBc Typical Sideband Suppression
- ◆ -174dBm/Hz Output Noise Density
- ◆ DC to 300MHz Baseband Input Allows a Direct Launch DAC Interface, Eliminating the Need for Costly I/Q Buffer Amplifiers
- ◆ DC-Coupled Input Allows Ability for Customer Offset Voltage Control

### Demodulator Operation:

- ◆ +35.2dBm Typical IIP3
- ◆ +76dBm Typical IIP2
- ◆ > 30dBm IP<sub>1dB</sub>
- ◆ 9.2dB Typical Conversion Loss
- ◆ 9.3dB Typical NF
- ◆ 0.06dB Typical I/Q Gain Imbalance
- ◆ 0.15° I/Q Typical Phase Imbalance

## Ordering Information

PART	TEMP RANGE	PIN-PACKAGE	PKG CODE
MAX2021ETX	-40°C to +85°C	36 Thin QFN-EP* (6mm x 6mm)	T3666-2
MAX2021ETX-T	-40°C to +85°C	36 Thin QFN-EP* (6mm x 6mm)	T3666-2
MAX2021ETX+	-40°C to +85°C	36 Thin QFN-EP* (6mm x 6mm)	T3666-2
MAX2021ETX+T	-40°C to +85°C	36 Thin QFN-EP* (6mm x 6mm)	T3666-2

\*EP = Exposed paddle. + = Lead free.

-T = Tape-and-reel package.

# High-Dynamic-Range, Direct Up-/Downconversion 750MHz to 1200MHz Quadrature Mod/Demod

## ABSOLUTE MAXIMUM RATINGS

VCC_ to GND .....	-0.3V to +5.5V	RBIASLO3 Maximum Current .....	10mA
BBI+, BBI-, BBQ+, BBQ- to GND.....	-3.5V to (VCC + 0.3V)	$\theta_{JA}$ (without air flow) .....	34°C/W
LO, RF to GND Maximum Current .....	30mA	$\theta_{JA}$ (2.5m/s air flow) .....	28°C/W
RF Input Power .....	+30dBm	$\theta_{JC}$ (junction to exposed paddle) .....	8.5°C/W
Baseband Differential I/Q Input Power (Note A) .....	+20dBm	Junction Temperature .....	+150°C
LO Input Power .....	+10dBm	Storage Temperature Range .....	-65°C to +150°C
RBIASLO1 Maximum Current .....	10mA	Lead Temperature (soldering 10s, non-lead free).....	+245°C
RBIASLO2 Maximum Current .....	10mA	Lead Temperature (soldering 10s, lead free).....	+260°C

**Note A:** Maximum reliable continuous power applied to the baseband differential port is +20dBm from an external 100 $\Omega$  source.

Stresses beyond those listed under "Absolute Maximum Ratings" may cause permanent damage to the device. These are stress ratings only, and functional operation of the device at these or any other conditions beyond those indicated in the operational sections of the specifications is not implied. Exposure to absolute maximum rating conditions for extended periods may affect device reliability.

## DC ELECTRICAL CHARACTERISTICS

(MAX2021 Typical Application Circuit, VCC = +4.75V to +5.25V, GND = 0V, I/Q inputs terminated into 100 $\Omega$  differential, LO input terminated into 50 $\Omega$ , RF output terminated into 50 $\Omega$ , 0V common-mode input, R1 = 432 $\Omega$ , R2 = 619 $\Omega$ , R3 = 332 $\Omega$ , TC = -40°C to +85°C, unless otherwise noted. Typical values are at VCC = +5V, VBBI = VBBQ = 1.4V<sub>P-P</sub>, f<sub>IQ</sub> = 1MHz, TC = +25°C, unless otherwise noted.) (Notes 1, 2)

PARAMETER	SYMBOL	CONDITIONS	MIN	TYP	MAX	UNITS
Supply Voltage	VCC		4.75	5.00	5.25	V
Total Supply Current	ITOTAL	Pins 3, 13, 15, 31, 33 all connected to VCC	230	271	315	mA
Total Power Dissipation				1355	1654	mW

## AC ELECTRICAL CHARACTERISTICS (Modulator)

(MAX2021 Typical Application Circuit, VCC = +4.75V to +5.25V, GND = 0V, I/Q differential inputs driven from a 100 $\Omega$  DC-coupled source, 0V common-mode input, P<sub>LO</sub> = 0dBm, 750MHz ≤ f<sub>LO</sub> ≤ 1200MHz, 50 $\Omega$  LO and RF system impedance, R1 = 432 $\Omega$ , R2 = 619 $\Omega$ , R3 = 332 $\Omega$ , TC = -40°C to +85°C. Typical values are at VCC = +5V, VBBI = 1.4V<sub>P-P</sub> differential, VBBQ = 1.4V<sub>P-P</sub> differential, f<sub>IQ</sub> = 1MHz, f<sub>LO</sub> = 900MHz, TC = +25°C, unless otherwise noted.) (Notes 1, 2)

PARAMETER	SYMBOL	CONDITIONS	MIN	TYP	MAX	UNITS
<b>BASEBAND INPUT</b>						
Baseband Input Differential Impedance		f <sub>IQ</sub> = 1MHz		53		$\Omega$
BB Common-Mode Input Voltage Range			-3.5	0	+3.5	V
<b>LO INPUT</b>						
LO Input Frequency Range			750		1200	MHz
LO Input Drive			-6		+3	dBm
LO Input Return Loss		RF and IF terminated (Note 3)		12		dB
<b>I/Q MIXER OUTPUTS</b>						
Output IP3	OIP3	f <sub>BB1</sub> = 1.8MHz, f <sub>BB2</sub> = 1.9MHz		21.1		dBm
		f <sub>LO</sub> = 900MHz f <sub>LO</sub> = 1000MHz		22.3		
Output IP2	OIP2	f <sub>BB1</sub> = 1.8MHz, f <sub>BB2</sub> = 1.9MHz		57.9		dBm
Output P1dB		f <sub>BB</sub> = 25MHz, P <sub>LO</sub> = 0dBm		16.7		dBm
Output Power	POUT			0.7		dBm
Output Power Variation Over Temperature		TC = -40°C to +85°C		-0.016		dB/°C
Output-Power Flatness		Sweep f <sub>BB</sub> , P <sub>RF</sub> flatness for f <sub>BB</sub> from 1MHz to 50MHz		0.15		dB

# High-Dynamic-Range, Direct Up-/Downconversion 750MHz to 1200MHz Quadrature Mod/Demod

## AC ELECTRICAL CHARACTERISTICS (Modulator) (continued)

(MAX2021 Typical Application Circuit,  $V_{CC} = +4.75V$  to  $+5.25V$ ,  $GND = 0V$ , I/Q differential inputs driven from a  $100\Omega$  DC-coupled source,  $0V$  common-mode input,  $P_{LO} = 0dBm$ ,  $750MHz \leq f_{LO} \leq 1200MHz$ ,  $50\Omega$  LO and RF system impedance,  $R1 = 432\Omega$ ,  $R2 = 619\Omega$ ,  $R3 = 332\Omega$ ,  $T_C = -40^\circ C$  to  $+85^\circ C$ . Typical values are at  $V_{CC} = +5V$ ,  $V_{BBI} = 1.4V_{P-P}$  differential,  $V_{BBQ} = 1.4V_{P-P}$  differential,  $f_{IQ} = 1MHz$ ,  $f_{LO} = 900MHz$ ,  $T_C = +25^\circ C$ , unless otherwise noted.) (Notes 1, 2)

PARAMETER	SYMBOL	CONDITIONS	MIN	TYP	MAX	UNITS
ACLR (1st Adjacent Channel 5MHz Offset)		Single-carrier WCDMA (Note 4)		65		dBc
LO Leakage		No external calibration, with each baseband input terminated in $50\Omega$		-32		dBm
Sideband Suppression		No external calibration, $f_{LO} = 920MHz$	$P_{LO} = 0dBm$	30	39.6	dBc
			$P_{LO} = -3dBm$		43.5	
Output Noise Density		Each baseband input terminated in $50\Omega$ (Note 5)		-174		dBm/Hz
Output Noise Floor		$P_{OUT} = 0dBm$ , $f_{LO} = 900MHz$ (Note 6)		-168		dBm/Hz
RF Return Loss		(Note 3)		15		dB

## AC ELECTRICAL CHARACTERISTICS (Demodulator)

(MAX2021 Typical Application Circuit when operated as a demodulator,  $V_{CC} = +4.75V$  to  $+5.25V$ ,  $GND = 0V$ , differential baseband outputs converted to a  $50\Omega$  single-ended output,  $P_{RF} = P_{LO} = 0dBm$ ,  $750MHz \leq f_{LO} \leq 1200MHz$ ,  $50\Omega$  LO and RF system impedance,  $R1 = 432\Omega$ ,  $R2 = 619\Omega$ ,  $R3 = 332\Omega$ ,  $T_C = -40^\circ C$  to  $+85^\circ C$ . Typical values are at  $V_{CC} = +5V$ ,  $T_C = +25^\circ C$ , unless otherwise noted.) (Notes 1, 2)

PARAMETER	SYMBOL	CONDITIONS	MIN	TYP	MAX	UNITS
<b>RF INPUT</b>						
RF Frequency	$f_{RF}$		750		1200	MHz
Conversion Loss	$L_C$	$f_{BB} = 25MHz$ (Note 7)		9.2		dB
Noise Figure	NF	$f_{LO} = 900MHz$		9.3		dB
Noise Figure Under-Blocking	NFBLOCK	$f_{BLOCKER} = 900MHz$ , $P_{RF} = 11dBm$ , $f_{RF} = f_{LO} = 890MHz$ (Note 8)		17.8		dB
Input Third-Order Intercept	IIP3	$f_{RF1} = 925MHz$ , $f_{RF2} = 926MHz$ , $f_{LO} = 900MHz$ , $P_{RF} = P_{LO} = 0dBm$ , $f_{SPUR} = 24MHz$		35.2		dBm
Input Second-Order Intercept	IIP2	$f_{RF1} = 925MHz$ , $f_{RF2} = 926MHz$ , $f_{LO} = 900MHz$ , $P_{RF} = P_{LO} = 0dBm$ , $f_{SPUR} = 51MHz$		76		dBm
Input 1dB Compression	$P_{1dB}$	$f_{IF} = 50MHz$ , $f_{LO} = 900MHz$ , $P_{LO} = 0dBm$		30		dBm
I/Q Gain Mismatch		$f_{BB} = 1MHz$ , $f_{LO} = 900MHz$ , $P_{LO} = 0dBm$		0.06		dB
I/Q Phase Mismatch		$f_{BB} = 1MHz$ , $f_{LO} = 900MHz$	$P_{LO} = 0dBm$		1.1	degrees
			$P_{LO} = -3dBm$		0.15	

**Note 1:** Guaranteed by design and characterization.

**Note 2:**  $T_C$  is the temperature on the exposed paddle.

**Note 3:** Parameter also applies to demodulator topology.

**Note 4:** Single-carrier WCDMA with 10.5dB peak-to-average ratio at 0.1% complementary cumulative distribution function,  $P_{RF} = -10dBm$  ( $P_{RF}$  is chosen to give -65dBc ACLR).

**Note 5:** No baseband drive input. Measured with the inputs terminated in  $50\Omega$ . At low output levels, the output noise is thermal.

**Note 6:** The output noise versus  $P_{OUT}$  curve has the slope of LO noise ( $L_n$  dBc/Hz) due to reciprocal mixing.

**Note 7:** Conversion loss is measured from the single-ended RF input to single-ended combined baseband output.

**Note 8:** The LO noise ( $L = 10^{(L_n/10)}$ ), determined from the modulator measurements can be used to deduce the noise figure under-blocking at operating temperature ( $T_p$  in Kelvin),  $F_{BLOCK} = 1 + (L_{cn} - 1) T_p / T_o + L_{PBLOCK} / (1000kT_o)$ , where  $T_o = 290K$ ,  $P_{BLOCK}$  in mW,  $k$  is Boltzmann's constant =  $1.381 \times 10^{-23}$  J/K, and  $L_{cn} = 10^{(L_c/10)}$ ,  $L_c$  is the conversion loss. Noise figure under-blocking in dB is  $NFBLOCK = 10 \times \log(F_{BLOCK})$ . Refer to *Application Note 3632*.

# High-Dynamic-Range, Direct Up-/Downconversion 750MHz to 1200MHz Quadrature Mod/Demod

## Typical Operating Characteristics

(MAX2021 Typical Application Circuit,  $V_{CC} = +4.75V$  to  $+5.25V$ ,  $GND = 0V$ , I/Q differential inputs driven from a  $100\Omega$  DC-coupled source,  $0V$  common-mode input,  $P_{LO} = 0dBm$ ,  $750MHz \leq f_{LO} \leq 1200MHz$ ,  $50\Omega$  LO and RF system impedance,  $R1 = 432\Omega$ ,  $R2 = 619\Omega$ ,  $R3 = 332\Omega$ ,  $T_C = -40^\circ C$  to  $+85^\circ C$ . Typical values are at  $V_{CC} = +5V$ ,  $V_{BBI} = 1.4V_{P-P}$  differential,  $V_{BBQ} = 1.4V_{P-P}$  differential,  $f_{IQ} = 1MHz$ ,  $f_{LO} = 900MHz$ ,  $T_C = +25^\circ C$ , unless otherwise noted.)

**TOTAL SUPPLY CURRENT vs. TEMPERATURE ( $T_C$ )**

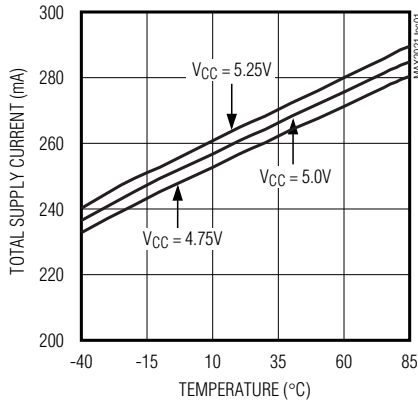

**MODULATOR**

**ACLR vs. OUTPUT POWER PER CARRIER**

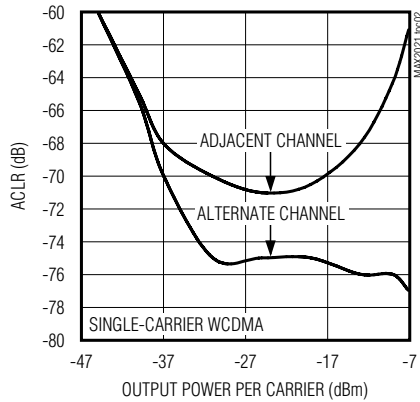

**ACLR vs. OUTPUT POWER PER CARRIER**

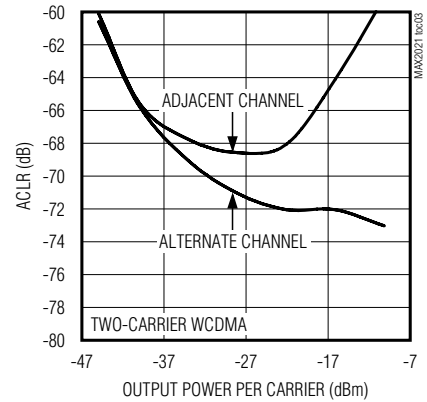

**ACLR vs. OUTPUT POWER PER CARRIER**

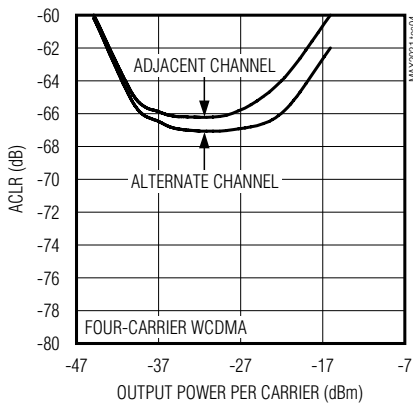

**SIDEBAND SUPPRESSION vs. LO FREQUENCY**

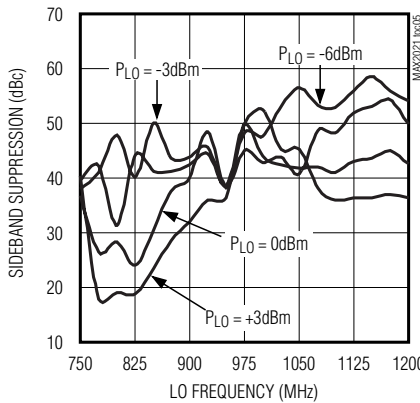

**SIDEBAND SUPPRESSION vs. LO FREQUENCY**

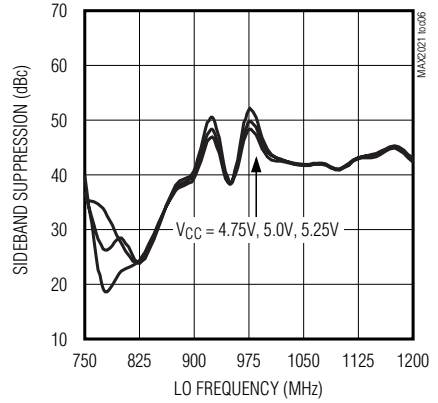

**SIDEBAND SUPPRESSION vs. LO FREQUENCY**

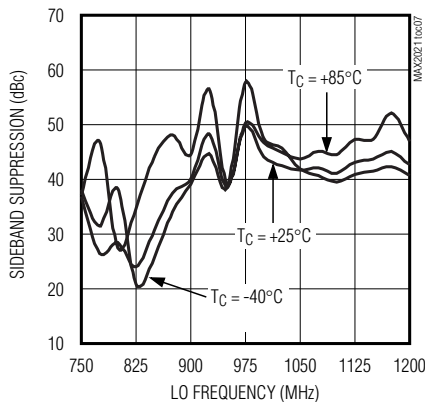

**OUTPUT IP3 vs. LO FREQUENCY**

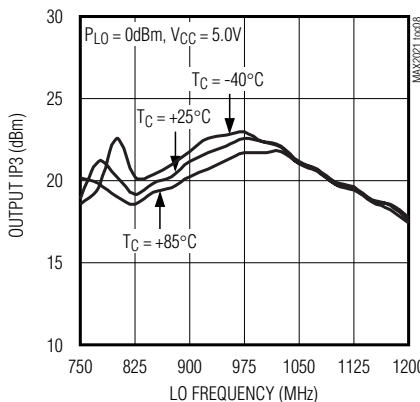

**OUTPUT IP3 vs. LO FREQUENCY**

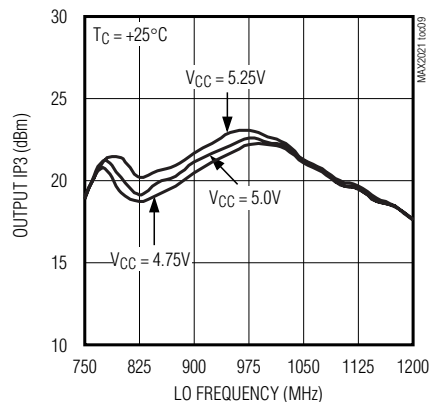

# High-Dynamic-Range, Direct Up-/Downconversion 750MHz to 1200MHz Quadrature Mod/Demod

## Typical Operating Characteristics (continued)

(MAX2021 Typical Application Circuit,  $V_{CC} = +4.75V$  to  $+5.25V$ ,  $GND = 0V$ , I/Q differential inputs driven from a  $100\Omega$  DC-coupled source,  $0V$  common-mode input,  $P_{LO} = 0dBm$ ,  $750MHz \leq f_{LO} \leq 1200MHz$ ,  $50\Omega$  LO and RF system impedance,  $R1 = 432\Omega$ ,  $R2 = 619\Omega$ ,  $R3 = 332\Omega$ ,  $T_C = -40^\circ C$  to  $+85^\circ C$ . Typical values are at  $V_{CC} = +5V$ ,  $V_{BBI} = 1.4V_{P-P}$  differential,  $V_{BBQ} = 1.4V_{P-P}$  differential,  $f_{IQ} = 1MHz$ ,  $f_{LO} = 900MHz$ ,  $T_C = +25^\circ C$ , unless otherwise noted.)

### MODULATOR

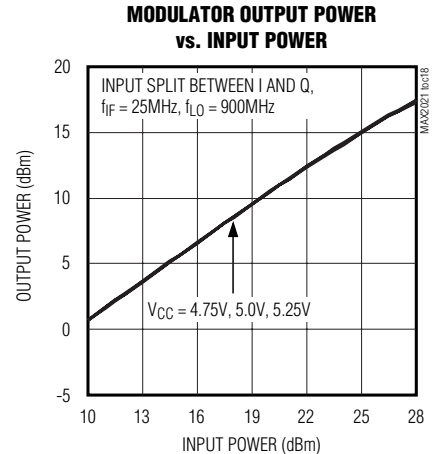
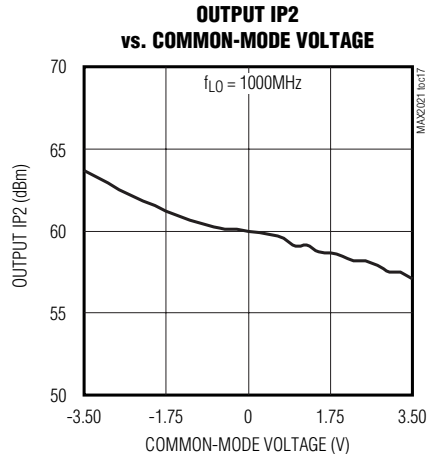
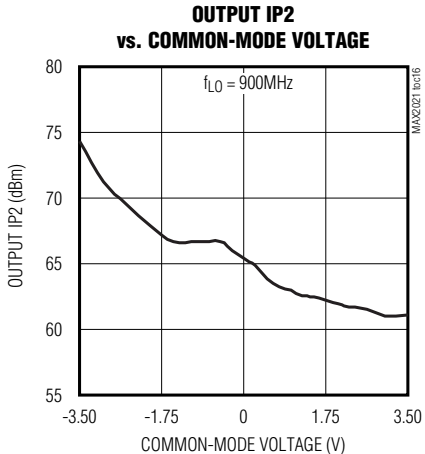
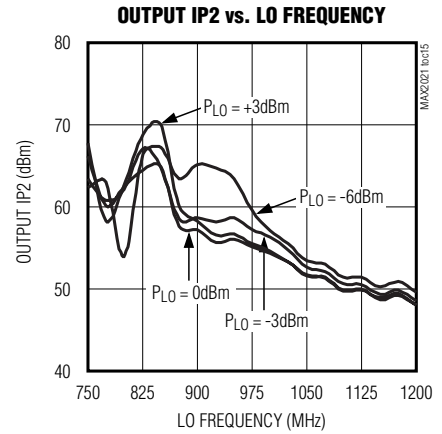
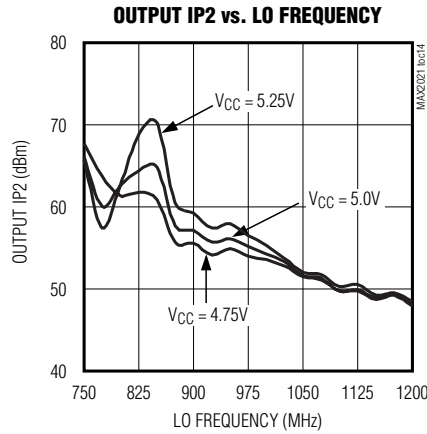
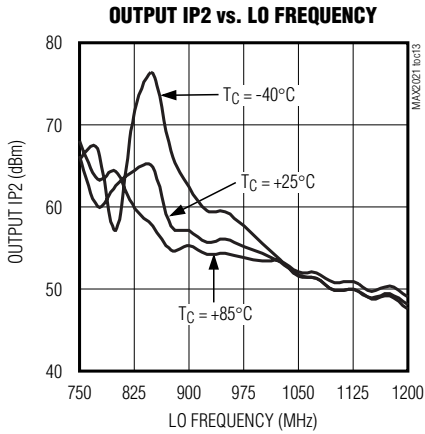
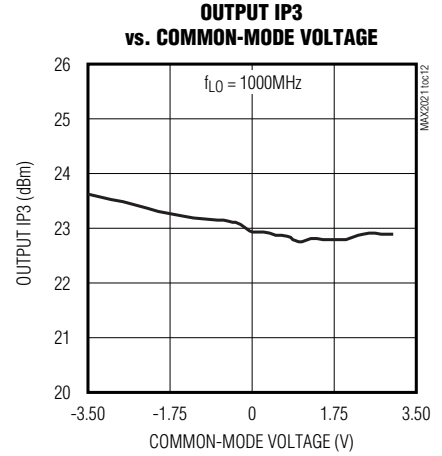
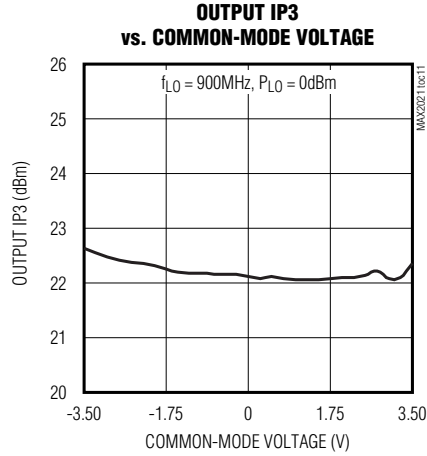
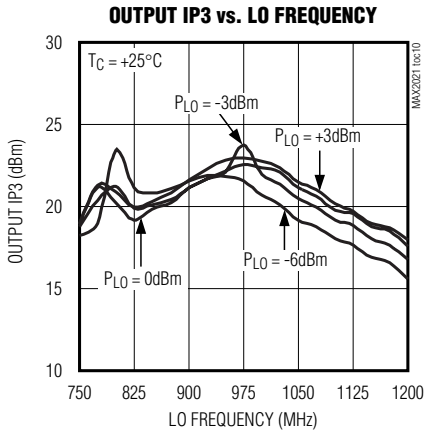

# High-Dynamic-Range, Direct Up-/Downconversion 750MHz to 1200MHz Quadrature Mod/Demod

## Typical Operating Characteristics (continued)

(MAX2021 Typical Application Circuit,  $V_{CC} = +4.75V$  to  $+5.25V$ ,  $GND = 0V$ , I/Q differential inputs driven from a  $100\Omega$  DC-coupled source,  $0V$  common-mode input,  $P_{LO} = 0dBm$ ,  $750MHz \leq f_{LO} \leq 1200MHz$ ,  $50\Omega$  LO and RF system impedance,  $R1 = 432\Omega$ ,  $R2 = 619\Omega$ ,  $R3 = 332\Omega$ ,  $T_C = -40^\circ C$  to  $+85^\circ C$ . Typical values are at  $V_{CC} = +5V$ ,  $V_{BBI} = 1.4V_{P-P}$  differential,  $V_{BBQ} = 1.4V_{P-P}$  differential,  $f_{IQ} = 1MHz$ ,  $f_{LO} = 900MHz$ ,  $T_C = +25^\circ C$ , unless otherwise noted.)

### MODULATOR

**MODULATOR OUTPUT POWER vs. INPUT POWER**

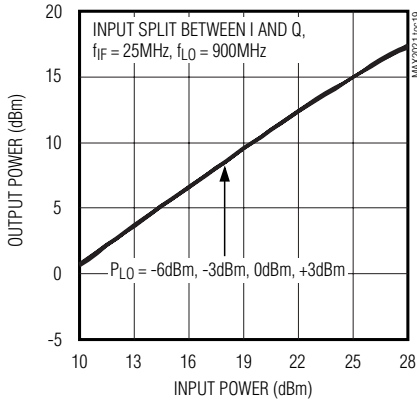

**MODULATOR OUTPUT POWER vs. LO FREQUENCY**

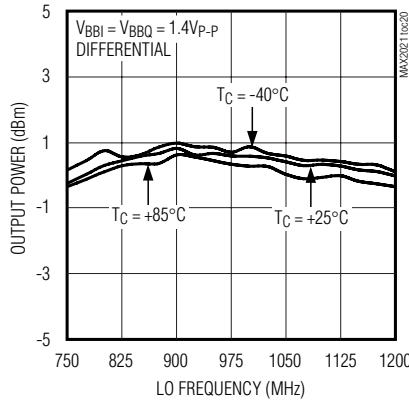

**LO LEAKAGE vs. LO FREQUENCY**

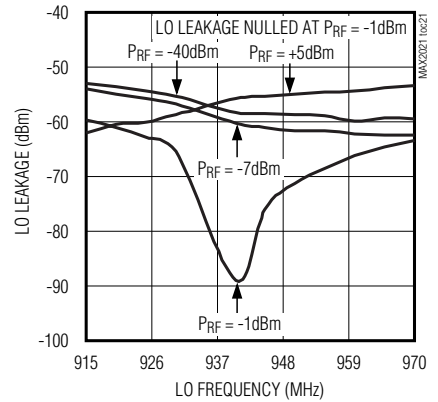

**LO LEAKAGE vs. LO FREQUENCY**

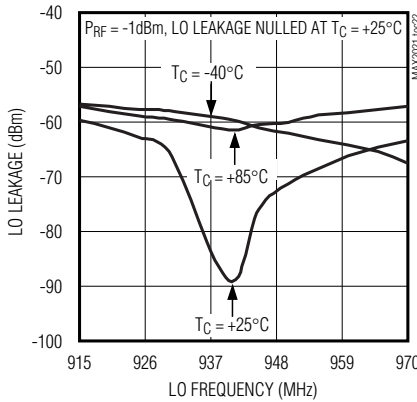

**LO LEAKAGE vs. LO FREQUENCY**

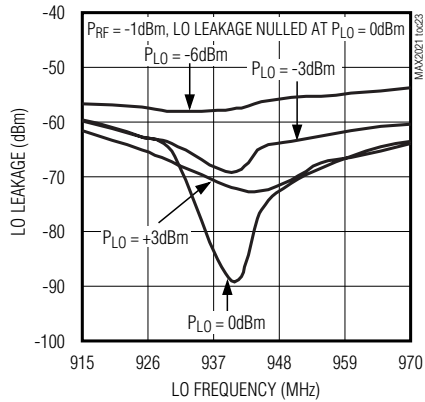

**OUTPUT NOISE vs. OUTPUT POWER**

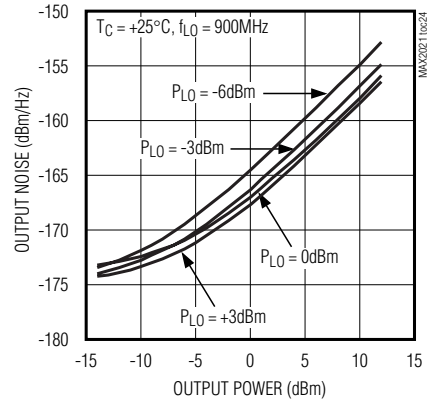

**OUTPUT NOISE vs. OUTPUT POWER**

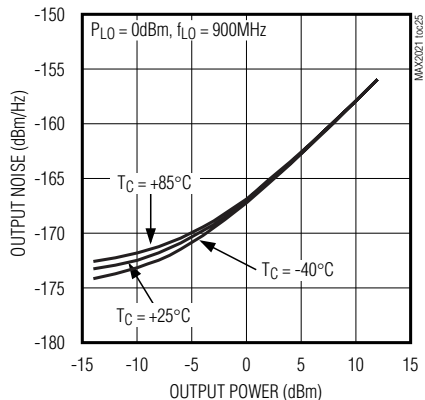

# High-Dynamic-Range, Direct Up-/Downconversion 750MHz to 1200MHz Quadrature Mod/Demod

## Typical Operating Characteristics

(MAX2021 Typical Application Circuit,  $V_{CC} = +4.75V$  to  $+5.25V$ ,  $GND = 0V$ , I/Q differential inputs driven from a  $100\Omega$  DC-coupled source,  $0V$  common-mode input,  $P_{RF} = 5dBm$ ,  $P_{LO} = 0dBm$ ,  $750MHz \leq f_{LO} \leq 1200MHz$ ,  $50\Omega$  LO and RF system impedance,  $R1 = 432\Omega$ ,  $R2 = 619\Omega$ ,  $R3 = 332\Omega$ ,  $T_C = -40^\circ C$  to  $+85^\circ C$ . Typical values are at  $V_{CC} = +5V$ ,  $f_{LO} = 900MHz$ ,  $T_C = +25^\circ C$ , unless otherwise noted.)

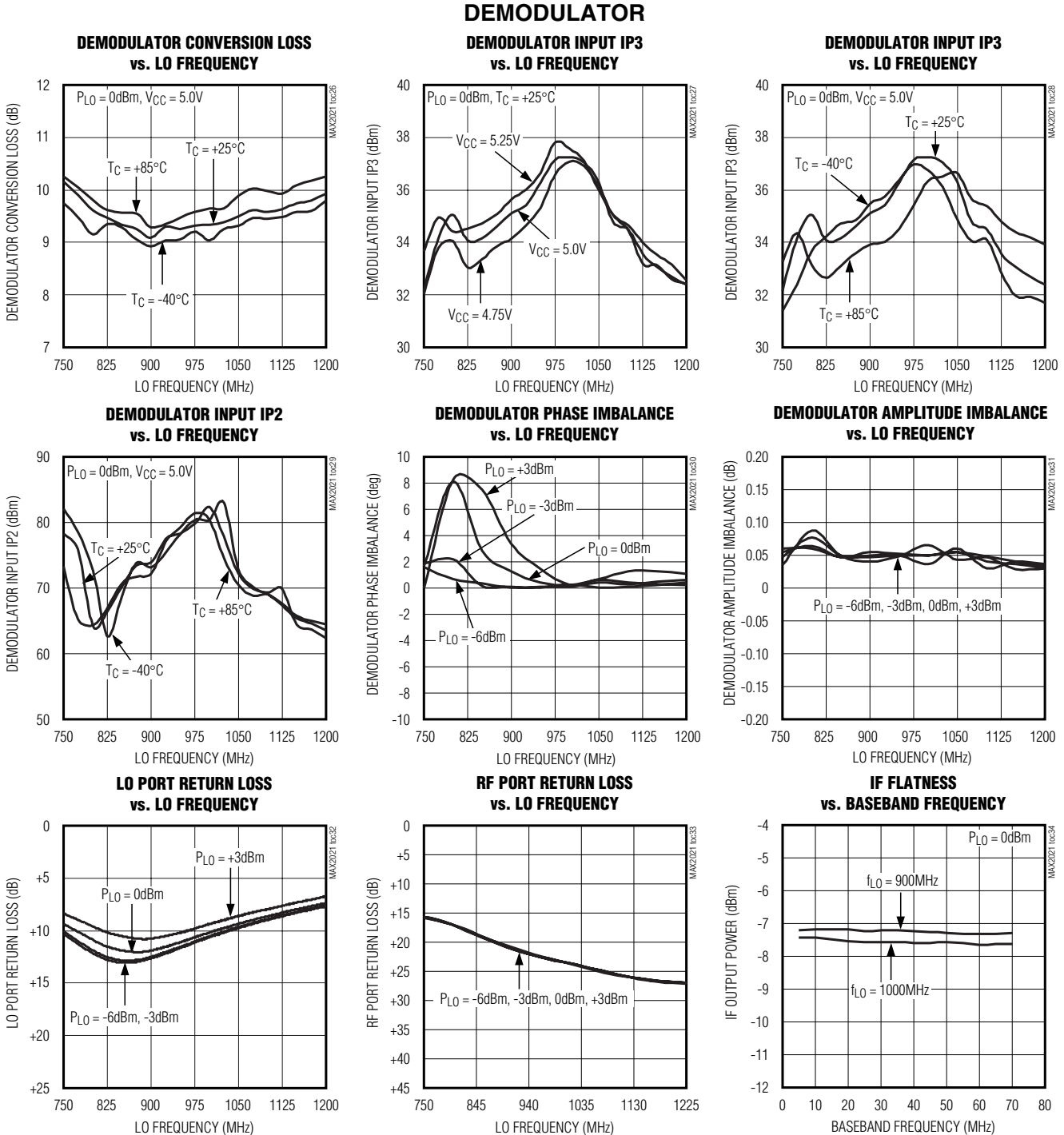

# High-Dynamic-Range, Direct Up-/Downconversion 750MHz to 1200MHz Quadrature Mod/Demod

## Pin Description

PIN	NAME	FUNCTION
1, 5, 9–12, 14, 16–19, 22, 24, 27–30, 32, 34, 35, 36	GND	Ground
2	RBIASLO3	3rd LO Amplifier Bias. Connect a 332 $\Omega$ resistor to ground.
3	VCCLOA	LO Input Buffer Amplifier Supply Voltage. Bypass to GND with 33pF and 0.1 $\mu$ F capacitors as close to the pin as possible.
4	LO	Local Oscillator Input. 50 $\Omega$ input impedance.
6	RBIASLO1	1st LO Input Buffer Amplifier Bias. Connect a 432 $\Omega$ resistor to ground.
7	N.C.	No Connection. Leave unconnected.
8	RBIASLO2	2nd LO Amplifier Bias. Connect a 619 $\Omega$ resistor to ground.
13	VCCLOI1	I-Channel 1st LO Amplifier Supply Voltage. Bypass to GND with 33pF and 0.1 $\mu$ F capacitors as close to the pin as possible.
15	VCCLOI2	I-Channel 2nd LO Amplifier Supply Voltage. Bypass to GND with 33pF and 0.1 $\mu$ F capacitors as close to the pin as possible.
20	BBI+	Baseband In-Phase Noninverting Port
21	BBI-	Baseband In-Phase Inverting Port
23	RF	RF Port
25	BBQ-	Baseband Quadrature Inverting Port
26	BBQ+	Baseband Quadrature Noninverting Port
31	VCCLOQ2	Q-Channel 2nd LO Amplifier Supply Voltage. Bypass to GND with 33pF and 0.1 $\mu$ F capacitors as close to the pin as possible.
33	VCCLOQ1	Q-Channel 1st LO Amplifier Supply Voltage. Bypass to GND with 33pF and 0.1 $\mu$ F capacitors as close to the pin as possible.
EP	GND	Exposed Ground Paddle. The exposed paddle <b>MUST</b> be soldered to the ground plane using multiple vias.

## Detailed Description

The MAX2021 is designed for upconverting differential in-phase (I) and quadrature (Q) inputs from baseband to a 750MHz to 1200MHz RF frequency range. The device can also be used as a demodulator, downconverting an RF input signal directly to baseband. Applications include RFID handheld and portal readers, as well as single and multicarrier GSM/EDGE, cdma2000, WCDMA, and iDEN base stations. Direct conversion architectures are advantageous since they significantly reduce transmitter or receiver cost, part count, and power consumption as compared to traditional IF-based double conversion systems.

The MAX2021 integrates internal baluns, an LO buffer, a phase splitter, two LO driver amplifiers, two matched double-balanced passive mixers, and a wideband quadrature combiner. The MAX2021's high-linearity mixers, in conjunction with the part's precise in-phase and quadrature channel matching, enable the device to possess excellent dynamic range, ACLR, 1dB compression

point, and LO and sideband suppression characteristics. These features make the MAX2021 ideal for four-carrier WCDMA operation.

### LO Input Balun, LO Buffer, and Phase Splitter

The MAX2021 requires a single-ended LO input, with a nominal power of 0dBm. An internal low-loss balun at the LO input converts the single-ended LO signal to a differential signal at the LO buffer input. In addition, the internal balun matches the buffer's input impedance to 50 $\Omega$  over the entire band of operation.

The output of the LO buffer goes through a phase splitter, which generates a second LO signal that is shifted by 90° with respect to the original. The 0° and 90° LO signals drive the I and Q mixers, respectively.

### LO Driver

Following the phase splitter, the 0° and 90° LO signals are each amplified by a two-stage amplifier to drive the I and Q mixers. The amplifier boosts the level of the LO



# High-Dynamic-Range, Direct Up-/Downconversion 750MHz to 1200MHz Quadrature Mod/Demod

signals to compensate for any changes in LO drive levels. The two-stage LO amplifier allows a wide input power range for the LO drive. The MAX2021 can tolerate LO level swings from -6dBm to +3dBm.

## I/Q Modulator

The MAX2021 modulator is composed of a pair of matched double-balanced passive mixers and a balun. The I and Q differential baseband inputs accept signals from DC to 300MHz with differential amplitudes up to 4V<sub>p-p</sub>. The wide input bandwidths allow operation of the MAX2021 as either a direct RF modulator or as an image-reject mixer. The wide common-mode compliance range allows for direct interface with the baseband DACs. No active buffer circuitry is required between the baseband DACs and the MAX2021 for cdma2000 and WCDMA applications.

The I and Q signals directly modulate the 0° and 90° LO signals and are upconverted to the RF frequency. The outputs of the I and Q mixers are combined through a balun to produce a singled-ended RF output.

## Applications Information

### LO Input Drive

The LO input of the MAX2021 is internally matched to 50Ω, and requires a single-ended drive at a 750MHz to 1200MHz frequency range. An integrated balun converts the singled-ended input signal to a differential signal at the LO buffer differential input. An external DC-blocking capacitor is the only external part required at this interface. The LO input power should be within the -6dBm to +3dBm range. An LO input power of -3dBm is recommended for best overall performance.

### Baseband I/Q Input Drive

Drive the MAX2021 I and Q baseband inputs differentially for best performance. The baseband inputs have a 53Ω differential input impedance. The optimum source impedance for the I and Q inputs is 100Ω differential. This source impedance achieves the optimal signal transfer to the I and Q inputs, and the optimum output RF impedance match. The MAX2021 can accept input power levels of up to +20dBm on the I and Q inputs. Operation with complex waveforms, such as CDMA carriers or GSM signals, utilize input power levels that are far lower. This lower power operation is made necessary by the high peak-to-average ratios of these complex waveforms. The peak signals must be kept below the compression level of the MAX2021. The input common-mode voltage should be confined to the -3.5V to +3.5V DC range.

The MAX2021 is designed to interface directly with Maxim high-speed DACs. This generates an ideal total

transmitter lineup, with minimal ancillary circuit elements. Such DACs include the MAX5875 series of dual DACs, and the MAX5895 dual interpolating DAC. These DACs have ground-referenced differential current outputs. Typical termination of each DAC output into a 50Ω load resistor to ground, and a 10mA nominal DC output current results in a 0.5V common-mode DC level into the modulator I/Q inputs. The nominal signal level provided by the DACs will be in the -12dBm range for a single CDMA or WCDMA carrier, reducing to -18dBm per carrier for a four-carrier application.

The I/Q input bandwidth is greater than 50MHz at -0.1dB response. The direct connection of the DAC to the MAX2021 ensures the maximum signal fidelity, with no performance-limiting baseband amplifiers required. The DAC output can be passed through a lowpass filter to remove the image frequencies from the DAC's output response. The MAX5895 dual interpolating DAC can be operated at interpolation rates up to x8. This has the benefit of moving the DAC image frequencies to a very high, remote frequency, easing the design of the baseband filters. The DAC's output noise floor and interpolation filter stopband attenuation are sufficiently good to ensure that the 3GPP noise floor requirement is met for large frequency offsets, 60MHz for example, with no filtering required on the RF output of the modulator.

Figure 1 illustrates the ease and efficiency of interfacing the MAX2021 with a Maxim DAC, in this case the MAX5895 dual 16-bit interpolating-modulating DAC.

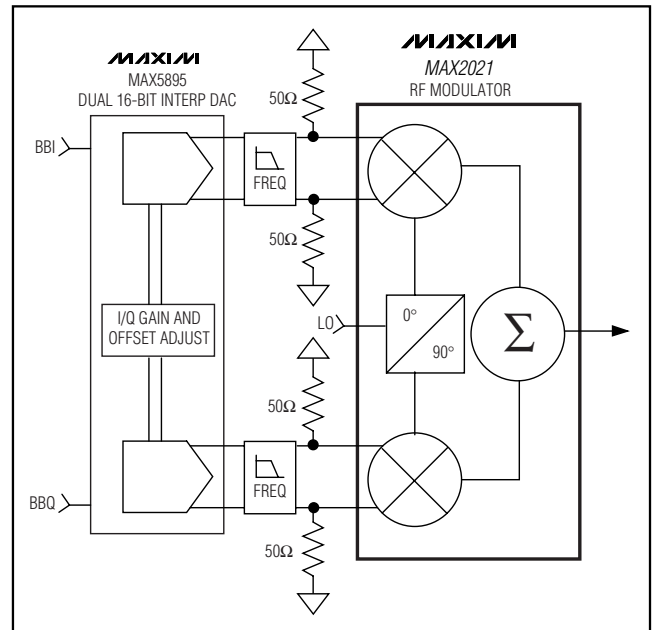

Figure 1. MAX5895 DAC Interfaced with MAX2021

# High-Dynamic-Range, Direct Up-/Downconversion 750MHz to 1200MHz Quadrature Mod/Demod

The MAX5895 DAC has programmable gain and differential offset controls built in. These can be used to optimize the LO leakage and sideband suppression of the MAX2021 quadrature modulator.

## RF Output

The MAX2021 utilizes an internal passive mixer architecture that enables the device to possess an exceptionally low-output noise floor. With such architectures, the total output noise is typically a power summation of the theoretical thermal noise (KTB) and the noise contribution from the on-chip LO buffer circuitry. As demonstrated in the *Typical Operating Characteristics*, the MAX2021's output noise approaches the thermal limit of  $-174\text{dBm/Hz}$  for lower output power levels. As the output power increases, the noise level tracks the noise contribution from the LO buffer circuitry, which is approximately  $-168\text{dBc/Hz}$ .

The I/Q input power levels and the insertion loss of the device determine the RF output power level. The input power is a function of the delivered input I and Q voltages to the internal  $50\Omega$  termination. For simple sinusoidal baseband signals, a level of  $89\text{mV}_{\text{P-P}}$  differential on the I and the Q inputs results in a  $-17\text{dBm}$  input power level delivered to the I and Q internal  $50\Omega$  terminations. This results in an RF output power of  $-23.2\text{dBm}$ .

## External Diplexer

LO leakage at the RF port can be nulled to a level less than  $-80\text{dBm}$  by introducing DC offsets at the I and Q ports. However, this null at the RF port can be compro-

mised by an improperly terminated I/Q IF interface. Care must be taken to match the I/Q ports to the driving DAC circuitry. Without matching, the LO's second-order ( $2f_{\text{LO}}$ ) term may leak back into the modulator's I/Q input port where it can mix with the internal LO signal to produce additional LO leakage at the RF output. This leakage effectively counteracts against the LO nulling. In addition, the LO signal reflected at the I/Q IF port produces a residual DC term that can disturb the nulling condition.

As demonstrated in Figure 2, providing an RC termination on each of the I+, I-, Q+, Q- ports reduces the amount of LO leakage present at the RF port under varying temperature, LO frequency, and baseband drive conditions. See the *Typical Operating Characteristics* for details. Note that the resistor value is chosen to be  $100\Omega$  with a corner frequency  $1 / (2\pi RC)$  selected to adequately filter the  $f_{\text{LO}}$  and  $2f_{\text{LO}}$  leakage, yet not affecting the flatness of the baseband response at the highest baseband frequency. The common-mode  $f_{\text{LO}}$  and  $2f_{\text{LO}}$  signals at I+/I- and Q+/Q- effectively see the RC networks and thus become terminated in  $50\Omega$  ( $R/2$ ). The RC network provides a path for absorbing the  $2f_{\text{LO}}$  and  $f_{\text{LO}}$  leakage, while the inductor provides high impedance at  $f_{\text{LO}}$  and  $2f_{\text{LO}}$  to help the diplexing process.

## RF Demodulator

The MAX2021 can also be used as an RF demodulator, downconverting an RF input signal directly to baseband. The single-ended RF input accepts signals from  $750\text{MHz}$  to  $1200\text{MHz}$  with power levels up to  $+30\text{dBm}$ . The passive mixer architecture produces a conversion loss of typically  $9.2\text{dB}$ . The downconverter is optimized for high linearity and excellent noise performance, typically with a  $+35.2\text{dBm}$  IIP3, a P1dB of greater than  $+30\text{dBm}$ , and a  $9.3\text{dB}$  noise figure.

A wide I/Q port bandwidth allows the port to be used as an image-reject mixer for downconversion to a quadrature IF frequency.

The RF and LO inputs are internally matched to  $50\Omega$ . Thus, no matching components are required, and only DC-blocking capacitors are needed for interfacing.

## Power Scaling with Changes to the Bias Resistors

Bias currents for the LO buffers are optimized by fine tuning resistors R1, R2, and R3. Maxim recommends using  $\pm 1\%$ -tolerant resistors; however, standard  $\pm 5\%$  values can be used if the  $\pm 1\%$  components are not readily available. The resistor values shown in the *Typical Application Circuit* were chosen to provide peak performance for the entire  $750\text{MHz}$  to  $1200\text{MHz}$  band. If desired, the current can be backed off from this nominal value by choosing different values for R1,

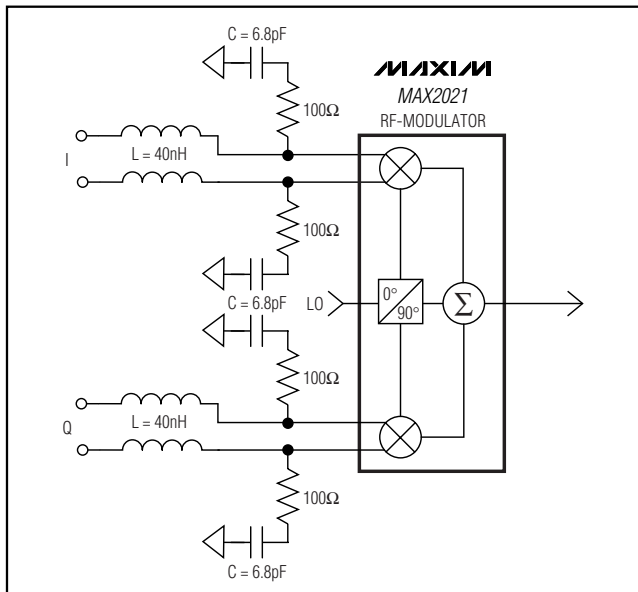

Figure 2. Diplexer Network Recommended for GSM 900 Transmitter Applications

# High-Dynamic-Range, Direct Up-/Downconversion 750MHz to 1200MHz Quadrature Mod/Demod

MAX2021

**Table 1. Typical Performance Trade-Offs as a Function of Current Draw—Modulator Mode**

LO FREQ (MHz)	RF FREQ (MHz)	R1 (Ω)	R2 (Ω)	R3 (Ω)	I <sub>cc</sub> (mA)	OIP3 (dBm)	LO LEAK (dBm)	IMAGE REJ (dBc)	OIP2 (dBm)
800	801.8	420	620	330	271	19.6	-32.1	23.9	50.5
		453	665	360	253	21.9	-32.7	34.0	51.0
		499	698	402	229	18.9	-33.7	30.0	52.6
		549	806	464	205	15.7	-34.4	23.7	46.0
		650	1000	550	173	13.6	-34.2	23.3	32.3
900	901.8	420	620	330	271	20.7	-31.4	43.4	54.0
		453	665	360	253	21.6	-31.6	42.4	55.4
		499	698	402	229	20.6	-31.8	42.7	59.8
		549	806	464	205	19.0	-31.9	40.3	50.7
		650	1000	550	173	14.9	-30.5	25.0	34.6
1000	1001.8	420	620	330	271	22.4	-32.8	39.3	55.5
		453	665	360	253	22.2	-33.2	39.1	56.3
		499	698	402	229	19.9	-33.8	43.5	55.0
		549	806	464	205	17.6	-34.8	40.5	51.4
		650	1000	550	173	14.6	-33.9	36.8	32.8

**Note:** V<sub>CC</sub> = 5V, P<sub>LO</sub> = 0dBm, T<sub>A</sub> = +25°C, I/Q voltage levels = 1.4V<sub>p-p</sub> differential.

R2, and R3. Tables 1 and 2 outline the performance trade-offs that can be expected for various combinations of these bias resistors. As noted within the tables, the performance trade-offs may be more pronounced for different operating frequencies. Contact the factory for additional details.

### Layout Considerations

A properly designed PC board is an essential part of any RF/microwave circuit. Keep RF signal lines as short as possible to reduce losses, radiation, and inductance. For the best performance, route the ground pin traces directly to the exposed pad under the package. The PC board exposed paddle **MUST** be connected to the ground plane of the PC board. It is suggested that multiple vias be used to connect this pad to the lower-level ground planes. This method provides a good RF/thermal conduction path for the device. Solder the exposed pad on the bottom of the device package to the PC board. The MAX2021 evaluation kit can be used as a reference for board layout. Gerber files are available upon request at [www.maxim-ic.com](http://www.maxim-ic.com).

### Power-Supply Bypassing

Proper voltage-supply bypassing is essential for high-frequency circuit stability. Bypass all VCC<sub>+</sub> pins with

33pF and 0.1μF capacitors placed as close to the pins as possible. The smallest capacitor should be placed closest to the device.

To achieve optimum performance, use good voltage-supply layout techniques. The MAX2021 has several RF processing stages that use the various VCC<sub>+</sub> pins, and while they have on-chip decoupling, off-chip interaction between them may degrade gain, linearity, carrier suppression, and output power-control range. Excessive coupling between stages may degrade stability.

### Exposed Pad RF/Thermal Considerations

The EP of the MAX2021's 36-pin thin QFN-EP package provides a low thermal-resistance path to the die. It is important that the PC board on which the IC is mounted be designed to conduct heat from this contact. In addition, the EP provides a low-inductance RF ground path for the device.

The exposed paddle (EP) **MUST** be soldered to a ground plane on the PC board either directly or through an array of plated via holes. An array of 9 vias, in a 3 x 3 array, is suggested. Soldering the pad to ground is critical for efficient heat transfer. Use a solid ground plane wherever possible.

# High-Dynamic-Range, Direct Up-/Downconversion 750MHz to 1200MHz Quadrature Mod/Demod

Table 2. Typical Performance Trade-Offs as a Function of Current Draw—Demodulator Mode

LO FREQ (MHz)	RF FREQ (MHz)	R1 (Ω)	R2 (Ω)	R3 (Ω)	I <sub>CC</sub> (mA)	CONVERSION LOSS (dB)	IIP3 (dBm)	57MHz IIP2 (dBm)
800	771	420	620	330	269	9.8	33.85	62.1
		453	665	360	254	9.83	33.98	62.9
		499	698	402	230	9.81	32.2	66.6
		549	806	464	207	9.84	31.1	66.86
		650	1000	550	173	9.95	29.87	65.25
900	871	420	620	330	269	9.21	33.1	68
		453	665	360	254	9.25	33.9	66.87
		499	698	402	230	9.36	34.77	66.7
		549	806	464	207	9.39	35.3	66.6
		650	1000	550	173	9.46	32	64.64
1000	971	420	620	330	269	9.47	34.9	> 77.7
		453	665	360	254	9.5	35.4	> 77.5
		499	698	402	230	9.53	34.58	> 76.5
		549	806	464	207	9.5	33.15	> 76.5
		650	1000	550	173	9.61	31.5	76

**Note:** Used on PC board 180° combiners and off PC board quadrature combiner with  $V_{CC} = 5V$ ,  $P_{RF} = -3dBm$ ,  $P_{LO} = 0dBm$ ,  $T_A = +25^{\circ}C$ ,  $IF1 = 28MHz$ ,  $IF2 = 29MHz$ .

# High-Dynamic-Range, Direct Up-/Downconversion 750MHz to 1200MHz Quadrature Mod/Demod

## Pin Configuration/Functional Diagram

**MAX2021**

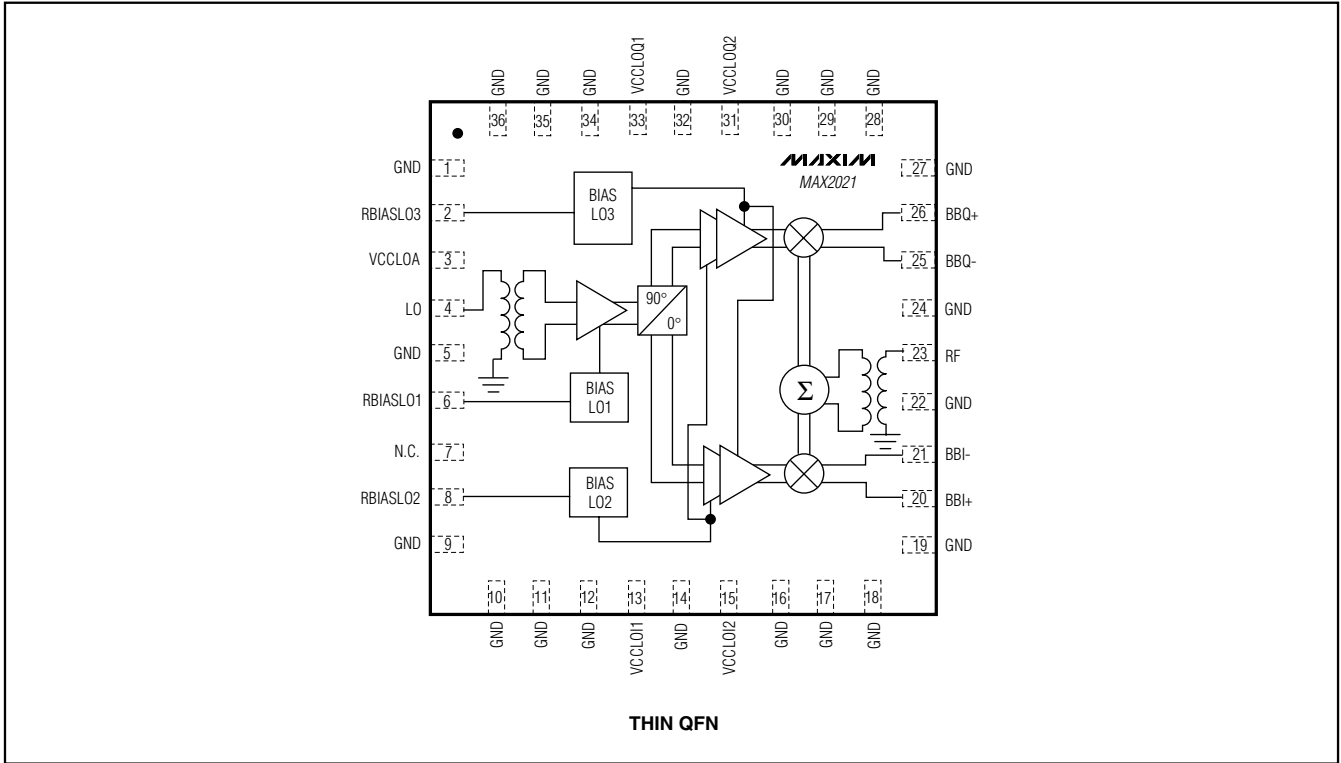

# High-Dynamic-Range, Direct Up-/Downconversion 750MHz to 1200MHz Quadrature Mod/Demod

## Typical Application Circuit

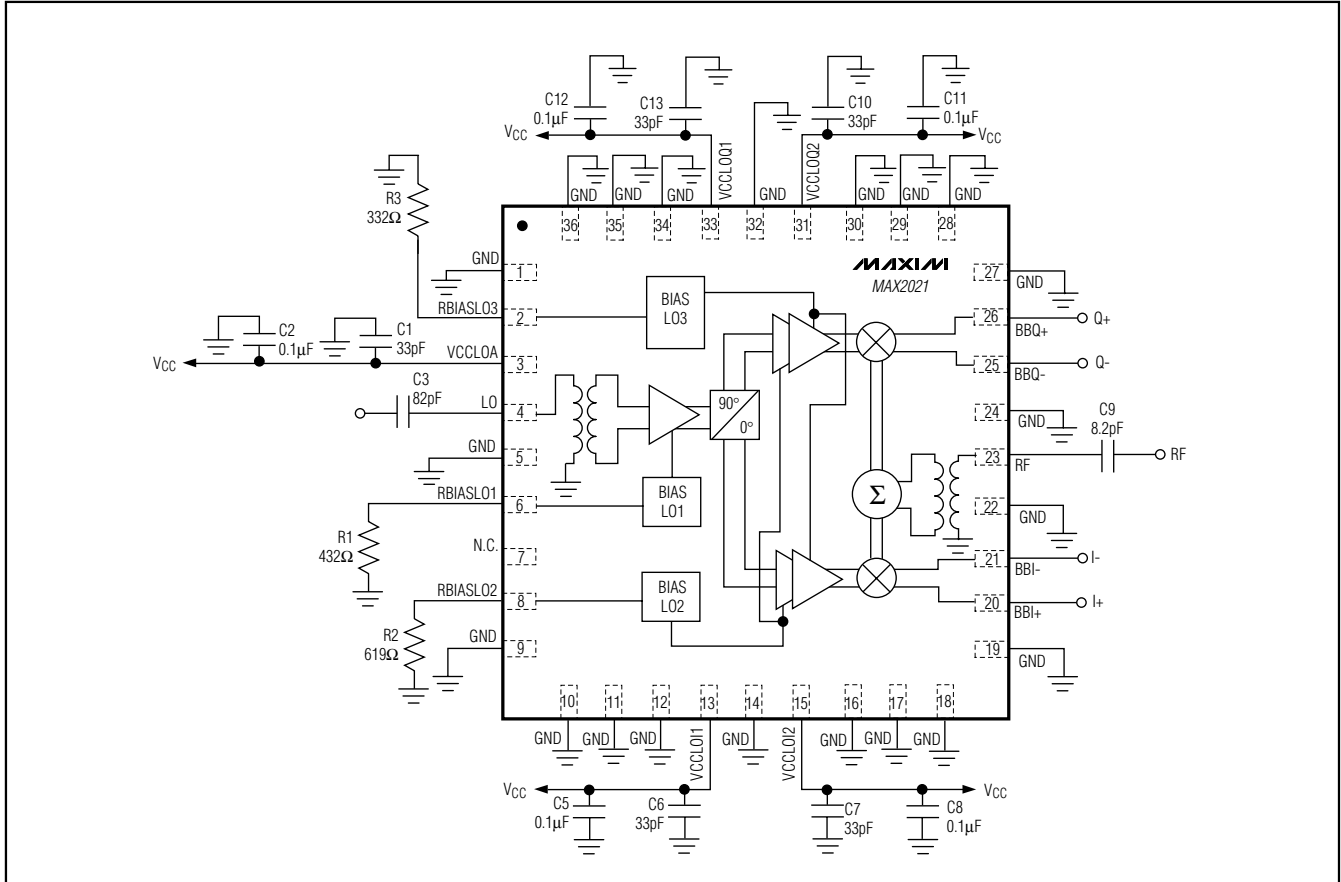

**Table 3. Component List Referring to the Typical Application Circuit**

COMPONENT	VALUE	DESCRIPTION
C1, C6, C7, C10, C13	33pF	33pF ±5%, 50V C0G ceramic capacitors (0402)
C2, C5, C8, C11, C12	0.1μF	0.1μF ±10%, 16V X7R ceramic capacitors (0603)
C3	82pF	82pF ±5%, 50V C0G ceramic capacitor (0402)
C9	8.2pF	8.2pF ±0.1pF, 50V C0G ceramic capacitor (0402)
R1	432Ω	432Ω ±1% resistor (0402)
R2	619Ω	619Ω ±1% resistor (0402)
R3	332Ω	332Ω ±1% resistor (0402)

### Chip Information

PROCESS: SiGe BiCMOS

### Package Information

For the latest package outline information, go to [www.maxim-ic.com/packages](http://www.maxim-ic.com/packages).

Maxim cannot assume responsibility for use of any circuitry other than circuitry entirely embodied in a Maxim product. No circuit patent licenses are implied. Maxim reserves the right to change the circuitry and specifications without notice at any time.

14 **Maxim Integrated Products, 120 San Gabriel Drive, Sunnyvale, CA 94086 408-737-7600**