

## Features

- Attenuation: 0.5 dB Steps to 15.5 dB
- Low DC Power Consumption
- Integral TTL Driver
- 50 ohm Impedance
- Test Boards are Available
- Tape and Reel Packaging Available
- Lead-Free SOW-16 Package
- 100% Matte Tin Plating over Copper
- Halogen-Free "Green" Mold Compound
- 260°C Reflow Compatible
- RoHS\* Compliant Version of AT65-0283

## Schematic with Off-Chip Components

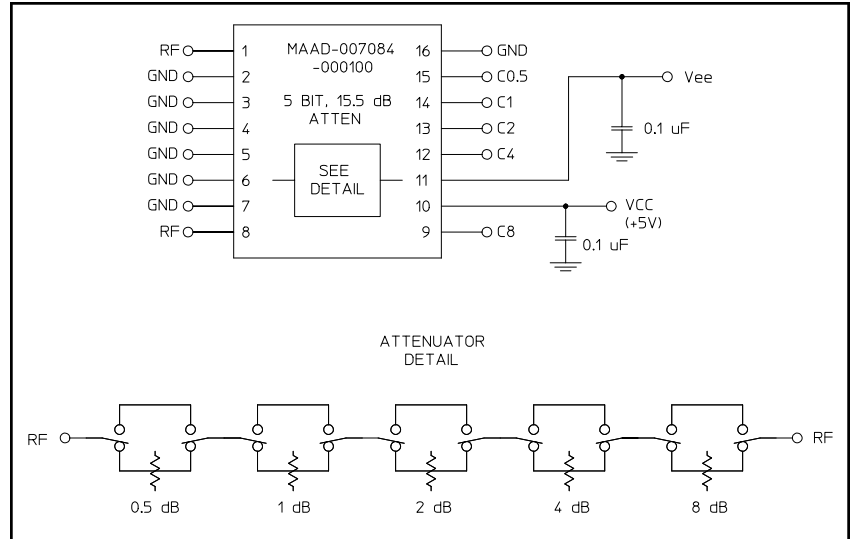

## Description

M/A-COM's MAAD-007084-000100 is a GaAs FET 5-bit digital attenuator with integral TTL driver. Step size is 0.5 dB providing a 15.5 dB total attenuation range. This device is in a SOW-16 plastic surface mount package. The MAAD-007084-000100 is ideally suited for use where accuracy, fast speed, very low power consumption and low costs are required.

## Pin Configuration

Pin No.	Function	Pin No.	Function
1	RF	9	C8
2	GND	10	Vcc
3	GND	11	Vee
4	GND	12	C4
5	GND	13	C2
6	GND	14	C1
7	GND	15	C0.5
8	RF	16	GND

## Ordering Information

Part Number	Package
MAAD-007084-000100	Bulk Packaging
MAAD-007084-0001TR	1000 piece reel
MAAD-007084-0001TB	Sample Test Board

Note: Reference Application Note M513 for reel size information.

Note: Die quantity varies.

## Truth Table (Digital Attenuator)

C8	C4	C2	C1	C0.5	Attenuation
0	0	0	0	0	Loss, Reference
0	0	0	0	1	0.5 dB
0	0	0	1	0	1.0 dB
0	0	1	0	0	2.0 dB
0	1	0	0	0	4.0 dB
1	0	0	0	0	8.0 dB
1	1	1	1	1	15.5 dB

0 = TTL Low; 1 = TTL High

\* Restrictions on Hazardous Substances, European Union Directive 2002/95/EC.

## Digital Attenuator 15.5 dB, 5-Bit, TTL Driver, DC-2.0 GHz

Rev. V2

### Electrical Specifications: $T_A = 25^\circ\text{C}$ , $Z_0 = 50\Omega$

Parameter	Test Conditions	Frequency	Units	Min	Typ	Max
Insertion Loss	—	DC - 1.0 GHz	dB	—	2.5	2.7
		DC - 2.0 GHz	dB	—	2.7	3.0
Attenuation Accuracy	Any Bit Any Combination of Bits	DC - 2.0 GHz	dB	—	—	$\pm(.3 + 4\% \text{ of atten})$
		DC -2.0 GHz	dB	—	—	$\pm (.3 + 6\% \text{ of atten})$
VSWR	Full Range	DC - 2.0 GHz	Ratio	—	1.5:1	2:1
Switching Speed <sup>1</sup>	50% Cntl to 90%/10% RF 10% to 90% or 90% to 10%	—	ns	—	75	150
		—	ns	—	20	50
1 dB Compression	—	50 MHz	dBm	—	+21	—
		0.5 - 2.0 GHz	dBm	—	+29	—
Input IP <sub>3</sub>	Two-tone inputs up to +5 dBm	50 MHz	dB	—	+35	—
		0.5-2.0 GHz	dB	—	+48	—
V <sub>CC</sub>	—	—	V	4.75	5.0	5.25
V <sub>EE</sub>	—	—	V	-8.0	-5.0	-4.75
V <sub>IL</sub> V <sub>IH</sub>	LOW-level input voltage HIGH-level input voltage	—	V	0.0	—	0.8
		—	V	2.0	—	5.0
I <sub>in</sub> (Input Leakage Current)	V <sub>in</sub> = V <sub>CC</sub> or GND	—	uA	-1.0	—	1.0
I <sub>CC</sub> (Quiescent Supply Current)	V <sub>cntrl</sub> = V <sub>CC</sub> or GND	—	uA	—	250	400
$\Delta I_{CC}^2$ (Additional Supply Current Per TTL Input Pin)	V <sub>CC</sub> = Max, V <sub>cntrl</sub> = V <sub>CC</sub> - 2.1 V	—	mA	—	—	1.0
I <sub>EE</sub>	V <sub>EE</sub> min to max, V <sub>in</sub> = V <sub>IL</sub> or V <sub>IH</sub>	—	mA	-1.0	-0.2	—

- Decoupling capacitors (.01  $\mu\text{F}$ ) are required on power supply lines.
- For calculating  $\Delta I_{CC}$ , the number of TTL input pins is 6.

### Absolute Maximum Ratings<sup>3,4</sup>

Parameter	Absolute Maximum
Max. Input Power 0.05 GHz 0.5 - 2.0 GHz	+27 dBm +34 dBm
V <sub>CC</sub>	$-0.5\text{V} \leq V_{CC} \leq +7.0\text{V}$
V <sub>EE</sub>	$-8.5\text{V} \leq V_{EE} \leq +0.5\text{V}$
V <sub>CC</sub> - V <sub>EE</sub>	$-0.5\text{V} \leq V_{CC} - V_{EE} \leq 14.5\text{V}$
V <sub>in</sub> <sup>5</sup>	$-0.5\text{V} \leq V_{in} \leq V_{CC} + 0.5\text{V}$
Operating Temperature	-40°C to +85°C
Storage Temperature	-65°C to +125°C

- Exceeding any one or combination of these limits may cause permanent damage to this device.
- M/A-COM does not recommend sustained operation near these survivability limits.
- Standard CMOS TTL interface, latch-up will occur if logic signal is applied prior to power supply.

### Handling Procedures

Please observe the following precautions to avoid damage:

### Static Sensitivity

Gallium Arsenide Integrated Circuits are sensitive to electrostatic discharge (ESD) and can be damaged by static electricity. Proper ESD control techniques should be used when handling these devices.

## Typical Performance Curves

### Insertion Loss

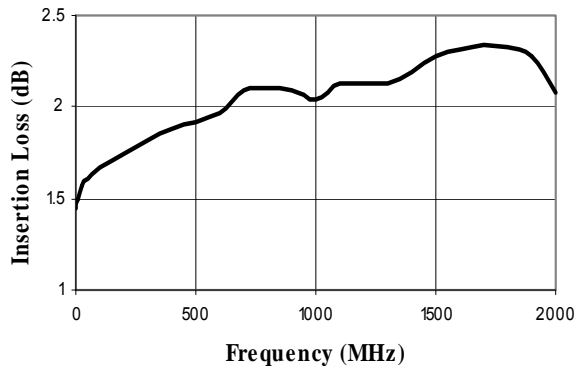

### Attenuation Accuracy 0.5, 1, 2, and 4 dB Bits

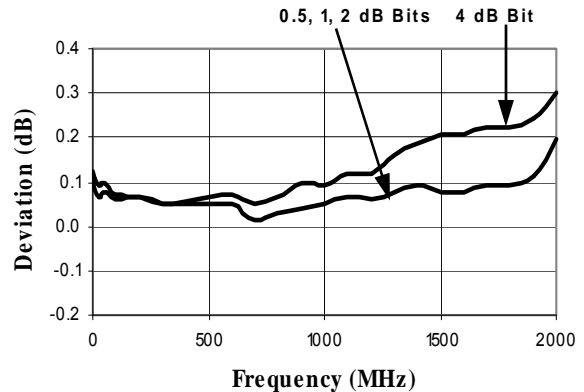

### Attenuation Accuracy 8 dB Bit and Max. Attenuation

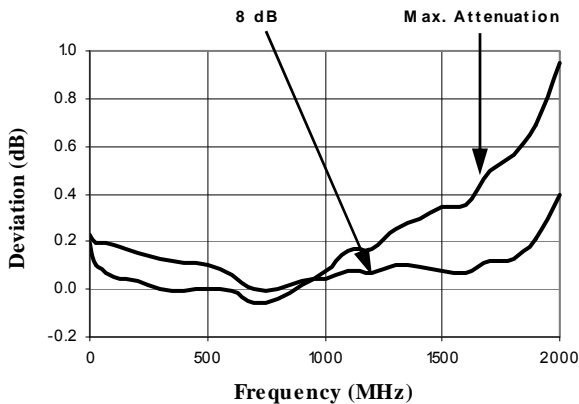

### VSWR @ Insertion Loss

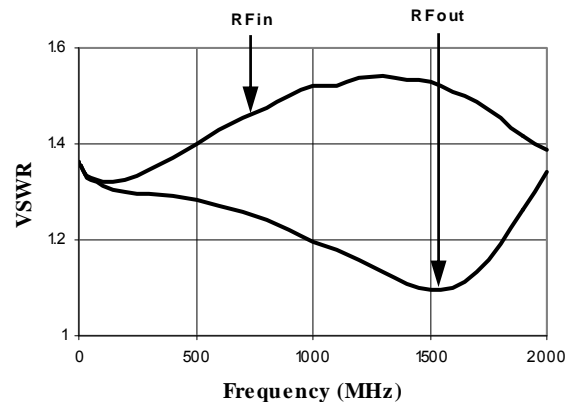

### VSWR RF OUT 0.5, 1, 2, and 4 dB Bits

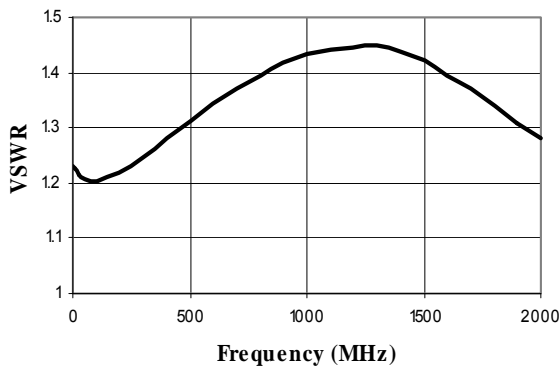

### VSWR RF IN 0.5, 1, 2, 4, 8 dB Bits and Max. Attenuation

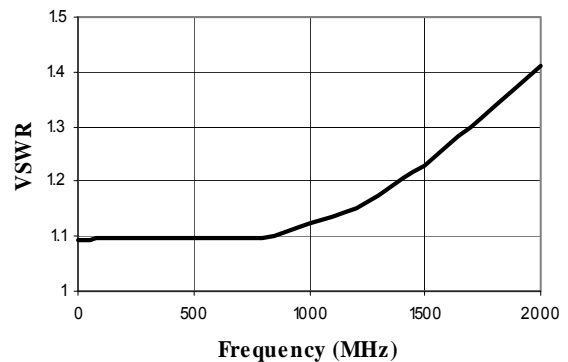

## Typical Performance Curves

### VSWR RF OUT 8 dB Bit and Max. Attenuation

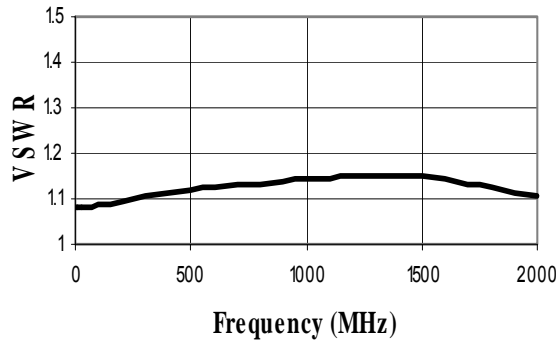

## Lead-Free, SOW-16†

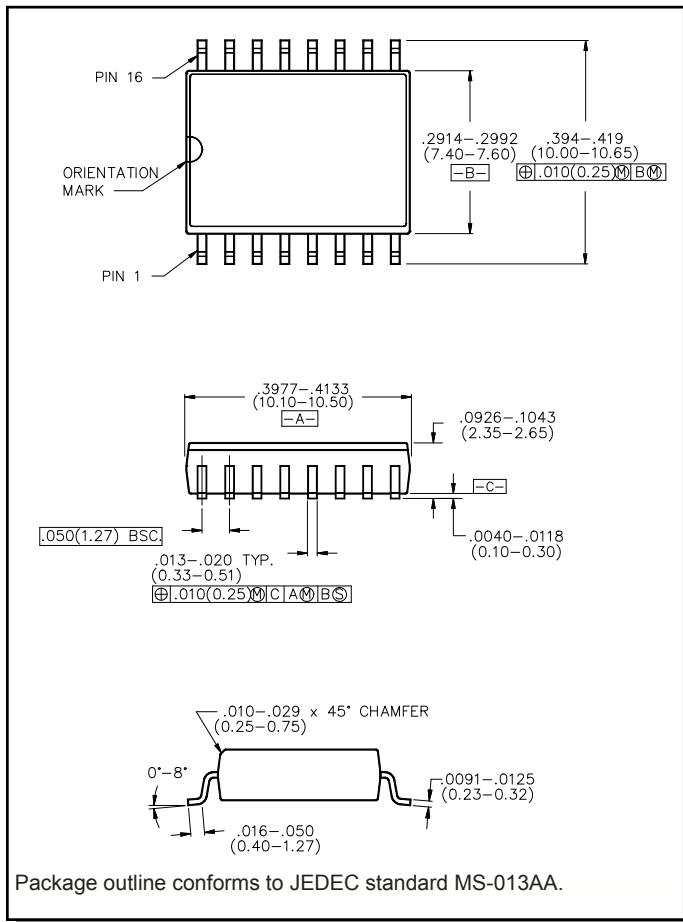

† Reference Application Note M538 for lead-free solder reflow recommendations.