

PLEASE CHECK WWW.MOLEX.COM FOR LATEST PART INFORMATION

Part Number: **0002062103**
Status: **Active**
Overview: [standard_062](#)
Description: 1.57mm (.062") Diameter, Standard .062" Pin and Socket Crimp Terminal, Series 1560, Male, with Tin (Sn) Plated Brass Contact, 18-24 AWG, Bag

Documents:

[Drawing \(PDF\)](#) [RoHS Certificate of Compliance \(PDF\)](#)

General

Product Family	Crimp Terminals
Series	1560
Crimp Quality Equipment	Yes
MolexKits	Yes
Overview	standard_062
Product Name	Standard .062"

Physical

Gender	Male
Material - Metal	Brass
Material - Plating Mating	Tin
Material - Plating Termination	Tin
Packaging Type	Bag
Plating min: Mating (µin)	20
Plating min: Mating (µm)	0.50
Plating min: Termination (µin)	20
Plating min: Termination (µm)	0.50
Termination Interface: Style	Crimp or Compression
Wire Insulation Diameter	1.52-3.05mm (.060-.120")
Wire Size AWG	18, 20, 22, 24
Wire Size mm ²	N/A

Material Info

Old Part Number 1560-(P901)L

Reference - Drawing Numbers

Sales Drawing SD-1560-*



image - Reference only

EU RoHS

**ELV and RoHS
Compliant**
**REACH SVHC
Contains SVHC: No**
**Halogen-Free
Status**

China RoHS



**Need more information on product
environmental compliance?**

Email productcompliance@molex.com
 For a multiple part number RoHS Certificate of Compliance, [click here](#)

Please visit the [Contact Us](#) section for any non-product compliance questions.

Search Parts in this Series

[1560Series](#)

Application Tooling | [FAQ](#)

Tooling specifications and manuals are found by selecting the products below. Crimp Height Specifications are then contained in the Application Tooling Specification document.

Global

Description	Product #
Hand Crimper - DISTRIBUTION ONLY	0638111000
Manual Extraction Tool	0011030002
Hand Crimp Tool for Standard .062" Pin and Socket Crimp Terminals, 18-24 AWG	0638191300

Japan

Description	Product #
Hand Insertion Tool	0011020001

This document was generated on 06/07/2010

PLEASE CHECK WWW.MOLEX.COM FOR LATEST PART INFORMATION

PART NO. ENG. NO.

02-06-2101	1560-(P901)
02-06-2103	1560-(P901)L
02-06-6101	1560-(561)
02-06-6102	1560-(561)L
02-06-6118	1560-(228)
02-06-6119	1560-(228)L
02-06-6116	1560-(231)
02-06-6112	1560-(231)L
02-06-6100	1560-(550)
02-06-6103	1560-(550)L
02-06-6105	1560-(591)
02-06-6104	1560-(591)L

LEGEND

1560-(****)*
 P=PREPLATE FORM
 BLANK=POSTPLATE BLANK=CHAIN
 FINISH CODE L=LOOSE

NOTES:

- MATERIAL: BRASS
- FINISHES:
 - 901 HOT TIN DIP (.00051)/.000020 MIN.
 - *228 SELECT GOLD PLATE (.00075)/.000030 MIN. IN CONTACT AREA, SELECT TIN (.00250)/.000100 MIN. IN CRIMP AREA OVER (.00125)/.000050 MIN. NICKEL OVERALL.
 - *231 SELECT GOLD PLATE (.00125)/.000050 MIN. IN CONTACT AREA, SELECT TIN (.00250)/.000100 MIN. IN CRIMP AREA OVER (.00125)/.000050 MIN. NICKEL OVERALL.
 - 561 SELECT GOLD PLATE (.00076)/.000030 MIN. IN CONTACT AREA, OVER (.00127)/.000050 MIN. NICKEL OVERALL.
 - 591 SELECT GOLD PLATE (.00127)/.000050 MIN. IN CONTACT AREA, OVER (.00127)/.000050 MIN. NICKEL OVERALL WITH (.000025)/.000010 MAX. GOLD FLASH OVERALL.
 - 550 SELECT GOLD PLATE (.00038)/.000015 MIN. IN CONTACT AREA, OVER (.00076)/.000030 MIN. NICKEL OVERALL WITH (.000025)/.000010 MAX. GOLD FLASH OVERALL.
 - * THE PRIMARY SHIPPING CARTON WILL BE LABELED, "COMPLIANT TO RoHS DIRECTIVE" 2002/95/EC AND ELV ANNEX II OF DIRECTIVE 2000/53/EC, AND CARTONS WITHOUT THIS LABEL MAY CONTAIN PRODUCT WITH TIN-LEAD.
- PRODUCT SPECIFICATION: PS-02-06
- PACKAGING INFORMATION: NOT AVAILABLE
- TERMINAL FOR USE WITH (157)/.062 DIA. SERIES HOUSINGS AND WILL ACCEPT 18 THRU 24 AWG WIRE.

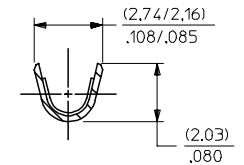
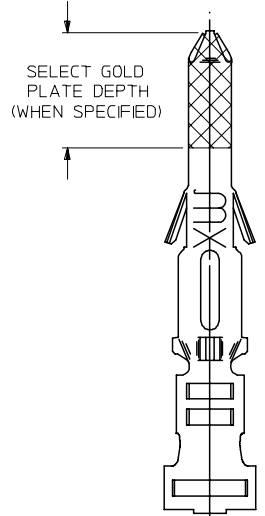
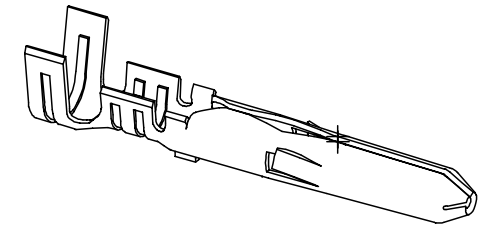
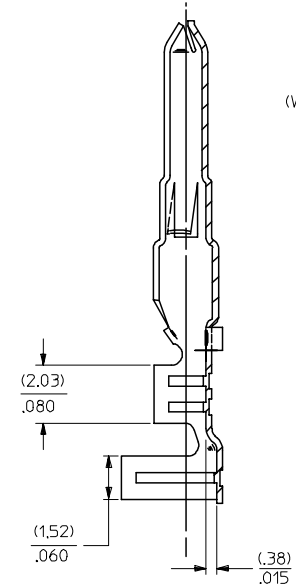
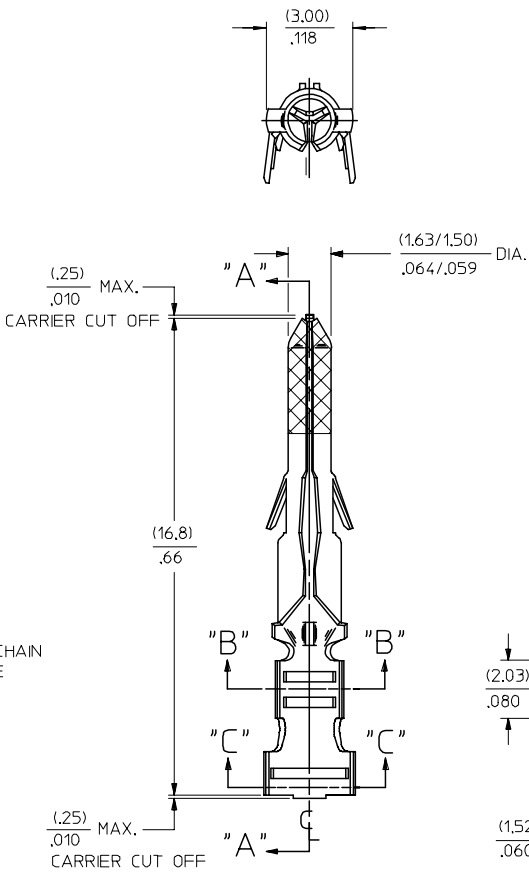

SECT. "B-B"
SCALE:10X

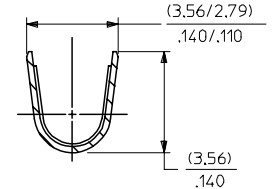

SECT. "C-C"
SCALE:10X

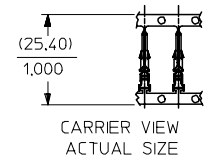

AP	REVSE Sn/Pb PLATE REDRAWN TO ME10 UCP2004-2097 RHOLTS 5/07/04
AO	REINSTATE 02066105 UCP2003-1827 ELHAG, 03/02/24
AN	OBSOLETE P/N UCR2002-0270 COMERC 01/9/25
AM1	ADDED ISO VIEW UCR1998-0228 WANG 98-05-21
AM	REV. & REDRAWN PER ECR 10372 GEP 8-19-87 RW

REFER TO REVISION BLOCK EC NO: 2002/06/2097 DRWNR:RHOLTS 2004/05/14 CHKD: 2004/05/14 APPR:FSMITH 2004/05/18	QUALITY SYMBOLS	GENERAL TOLERANCES (UNLESS SPECIFIED)	SCALE 8:1	DESIGN UNITS INCH	THIRD ANGLE PROJECTION	REVISE ON CAD ONLY
	DESCRIPTION	mm INCH	DIMENSION STYLE	TITLE	CRIMP TERMINAL, MALE .062 DIA. FOR 18-24 AWG WIRE	
AP	▽ = 0	4 PLACES ± --- ± ---	IN/MM	DRAWN BY GEP	DATE 1987/08/19	MOLEX INCORPORATED
	▽ = 0	3 PLACES ± --- ± .010		CHECKED BY RW	DATE 1987/08/19	
		2 PLACES ± 0.25 ± .014		APPROVED BY RAS	DATE 1987/08/19	MATERIAL NO. SEE CHART
		1 PLACE ± 0.35 ± ---				DOCUMENT NO. SD-1560-*
		ANGULAR ±1/2°				SHEET NO. 1 OF 1
		DRAFT WHERE APPLICABLE MUST REMAIN WITHIN DIMENSIONS				