



# PRODUCT SPECIFICATION

**Model No : CSLR-N502TG4-A0**

| Descriptions:    |                     |
|------------------|---------------------|
| ■ LED Type       | : Lighting LED Lamp |
| ■ LED Package    | : Round LED Lamp    |
| ■ Emitting Color | : Green             |
| ■ Viewing Angle  | : 15°               |
| ■ No Stopper     |                     |



| CUSTOMER APPROVED SIGNATURES | APPROVED BY | CHECKED BY | PREPARED BY |
|------------------------------|-------------|------------|-------------|
|                              |             |            |             |

**CHINA SEMICONDUCTOR CORPORATION**  
Address: 2FL. NO.909, Chung-Cheng Road,  
Chung-Ho City Taipei Hsien, Taiwan.

**OPTO PLUS TECHNOLOGIES CO.,LTD**  
Address: 696 Shun jiang Rd., Ji Shan St. Shaoxing,  
ZheJiang, China

Tel: 886-2-2223-9696  
Fax: 886-2-2223-9377

Tel: 86-0575-88623888  
Fax: 86-0575-88623112



|           |                  |
|-----------|------------------|
| Spec. No. | PS-LL-N502TG4-A0 |
| Rev.      | A                |

**Model No : CSLR-N502TG4-A0**

**Features -**

1. Low Power Consumption.
2. High Luminous Output
3. High Reliability and Solid Performance
4. Optimal Optical/Mechanical Design
5. Rohs Compliant

**Device Selection Guide -**

| Part No.        | Chip     |               | LED Lens          |
|-----------------|----------|---------------|-------------------|
|                 | Material | Emitted Color |                   |
| CSLR-N502TG4-A0 | InGaN    | Green         | Water Transparent |

**Package Outline Dimensions -**

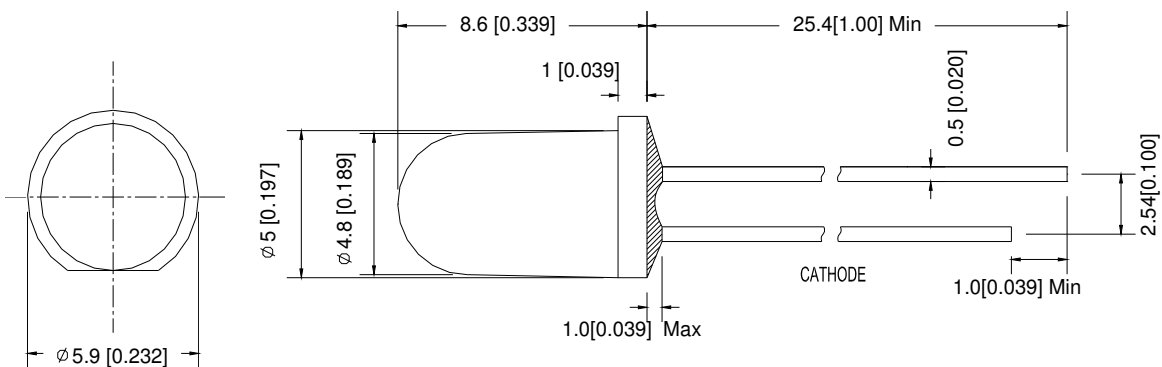

\* Tolerance :  $\pm \frac{0.01}{0.25}$  Unit :  $\pm \frac{\text{inch}}{\text{mm}}$



|           |                  |
|-----------|------------------|
| Spec. No. | PS-LL-N502TG4-A0 |
| Rev.      | A                |

Model No : CSLR-N502TG4-A0

■ Absolute Maximum Rating -

(Ta=25°C)

| Parameter                  | Symbol      | Rating   | Unit |
|----------------------------|-------------|--|------|
| Power Dissipation          | <b>Pd</b>   | 76   | mW   |
| Forward Current (DC)       | <b>IF</b>   | 30   | mA   |
| Peak Forward Current *     | <b>IFP</b>  | 100  | mA   |
| Reverse Voltage            | <b>VR</b>   | 5  | V    |
| Operating Temp.            | <b>Topr</b> | -30 ~ +80  | °C   |
| Storage Temp.              | <b>Tstg</b> | -40 ~ +100   | °C   |
| Lead Soldering Temperature | <b>Tsol</b> | Max. 260°C for 5 sec Max.<br>(3mm from the epoxy body) |      |

\* Pulse width  $\leq 0.1$  msec. duty  $\leq 1/10$

■ Electro-optical Characteristics

(Ta=25°C)

| Parameter           | Symbol                           | Min.  | Typ.  | Max.  | Unit    | Condition |
|---------------------|----------------------------------|-------|-------|-------|---------|-----------|
| Forward Voltage     | <b>VF</b>                        | ----- | 3.3   | 3.8   | V       | IF=20mA   |
| Luminous Intensity  | <b>Iv</b>                        | 14600 | 27000 | ----- | mcd     |           |
| Dominant Wavelength | <b><math>\lambda D</math></b>    | ----- | 525   | ----- | nm      |           |
| Viewing Angle       | <b>2 <math>\theta</math> 1/2</b> | ----- | 15    | ----- | deg     |           |
| Reverse Current     | <b>IR</b>                        | ----- | ----- | 50    | $\mu$ A | VR=5V     |



**Model No : CSLR-N502TG4-A0**

**■ Luminous Intensity Rank Limits (  $I_f = 20\text{mA}$  )**

unit : mcd

| Part No.<br>Code | CSLR-N502TG4-A0 |       |
|------------------|-----------------|-------|
|                  | min.            | max.  |
| Y                | 14600           | 19000 |
| Z                | 19000           | 24700 |
| Z1               | 24700           | 32100 |
| Z2               | 32100           | 41700 |

**■ Dominant Wavelength Rank Limits (  $I_f = 20\text{mA}$  )**

unit : nm

| Part No.<br>Code | CSLR-N502TG4-A0 |      |
|------------------|-----------------|------|
|                  | min.            | max. |
| TG2              | 520             | 525  |
| TG3              | 525             | 530  |
| TG4              | 530             | 535  |

**■ Forward Voltage Rank Limits (  $I_f = 20\text{mA}$  )**

unit : v

| Part No.<br>Code | CSLR-N502TG4-A0 |      |
|------------------|-----------------|------|
|                  | min.            | max. |
| H                | 2.8             | 3.0  |
| J                | 3.0             | 3.2  |
| K                | 3.2             | 3.4  |
| L                | 3.4             | 3.6  |
| M                | 3.6             | 3.8  |

Notes:

1. Tolerance of measurement of luminous intensity  $\pm 15\%$
2. Tolerance of measurement of Color Coordinates  $\pm 0.01$
3. Tolerance of measurement of forward voltage  $\pm 0.05\text{v}$
4. All data are measured by CSC's test equipment.
5. One delivery will include several color rank, VF rank and Iv ranks of the products.
6. The quantity-ratio of the ranks is decided by CSC.
7. Please confirm with CSC salesman, if your request different from standard specification.



|           |                  |
|-----------|------------------|
| Spec. No. | PS-LL-N502TG4-A0 |
| Rev.      | A                |

Model No : CSLR-N502TG4-A0

■ Typical Electrical / Optical Characteristics Curves -

(Ta = 25°C Unless Otherwise Noted)

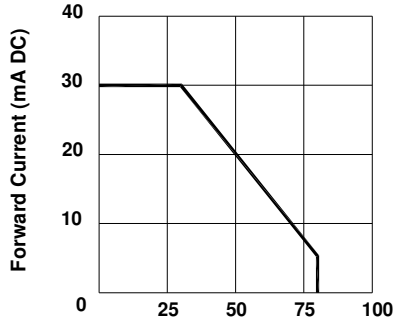

Ambient Temperature Ta (°C)  
Fig 1. Forward Current  
Vs. Ambient Temperature

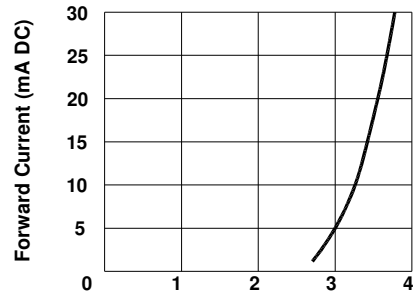

Forward Voltage VF (V)  
Fig 2. Forward Current  
Vs. Forward Voltage

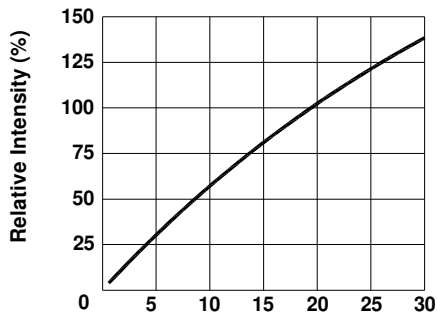

Forward Current IF (mA DC)  
Fig 3. Relative Intensity  
Vs. Forward Current

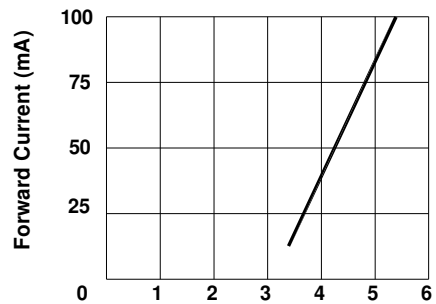

Forward Voltage (V)  
Fig 4. Peak Forward Voltage  
Vs. Forward Current  
(100us test pulse, 1% duty cycle)

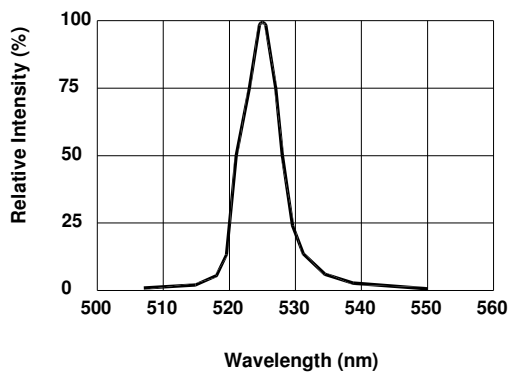

Fig 5. Relative Intensity Vs. Wavelength

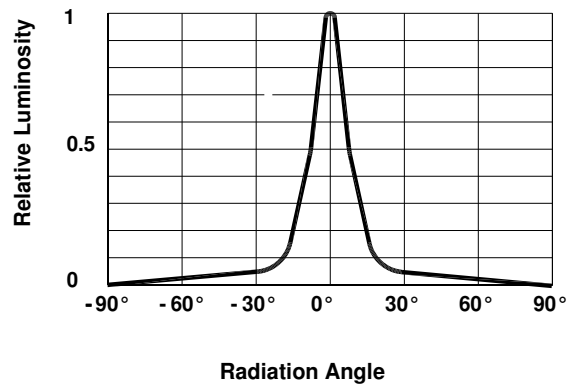

Fig 6. Relative Luminous Intensity vs. Radiation Angle



Model No : CSLR-N502TG4-A0

## ■ Precautions For Use -

### 1. Recommended Soldering conditions

#### Wave Soldering

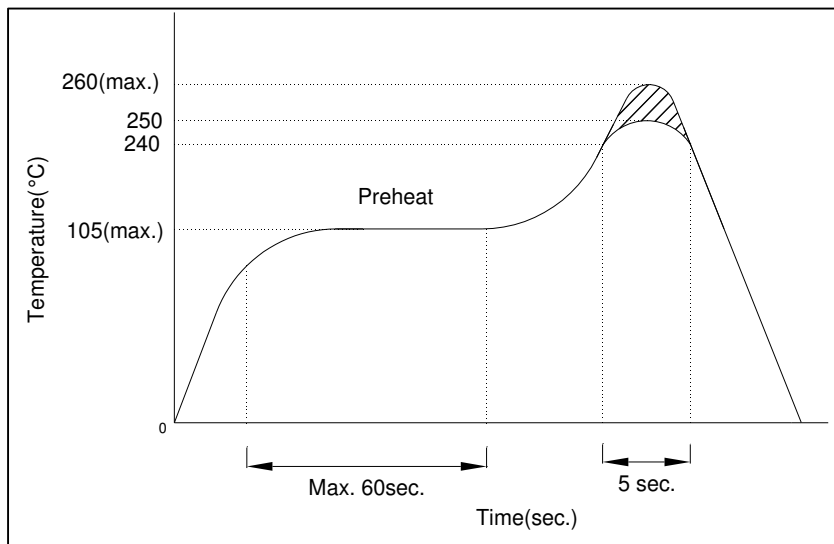

### 2. Soldering Iron

Basic SPEC. is  $\leq 5\text{sec.}$  When  $260^{\circ}\text{C}$ . If temperature is higher, time should be shorter ( $+10^{\circ}\text{C} \rightarrow -1\text{sec.}$ ). Power dissipation of iron should be smaller than 15W, and temperature should be controllable. Surface temperature of the device should be under  $230^{\circ}\text{C}$ .

### 3. Static Electricity

- a. Static electricity or surge voltage damages LEDs..

It is recommended that a wrist band or an anti-electrostatic glove be used when handling the LEDs.

- b. All devices, equipment and machinery must be properly grounded. It is recommended that measures be taken against surge voltage to the equipment that mounts the LEDs.

Note: The specifications are subject to change without notice. Please contact us for updated information.