



Features

- RoHS compliant*
- Halogen free**
- ESD protection
- Protects 2 lines
- Low leakage current
- Low capacitance

Applications

- Ethernet - 10/100/1000 Base T
- Firewire and USB
- Portable electronics
- Video/Graphic Cards

CD143A-SR2.8~3.3 – Steering/TVS Diode Array Series

General Information

The CD143A-SR2.8 and CD143A-SR3.3 devices provides ESD protection for the external ports of portable electronic devices such as cell phones, handheld electronics and personal computers.

The ESD protection provided by the component enables a data port to withstand a minimum ± 8 KV Contact / ± 15 KV Air Discharge per the ESD test method specified in IEC 61000-4-2. The device measures 2.80 mm x 1.20 mm and is available in a SOT-143 package intended to be mounted directly onto an FR4 printed circuit board.

The Bourns® device will meet IEC 61000-4-2 (ESD), IEC 61000-4-4 (EFT) and IEC 61000-4-5 (Surge) requirements.

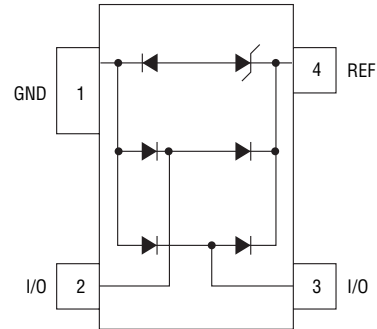

Absolute Maximum Ratings (@ T_A = 25 °C Unless Otherwise Noted)

Parameter	Symbol	Value	Unit
Peak Pulse Power ($t_p = 8/20 \mu s$) ¹	P _{PP}	200	W
Peak Pulse Current ($t_p = 8/20 \mu s$)	I _{PP}	12	A
Operating Supply Voltage (V _{dd} - Gnd)	V _{dc}	3.8	V
ESD per IEC 61000-4-2 (Air) (Contact)	V _{esd}	± 30	kV
DC Voltage at any I/O Pin	V _{io}	(Gnd - 0.50) to (V _{dd} + 0.5)	V
Operating Temperature	T _J	-55 °C to 125 °C	°C
Storage Temperature	T _{STG}	-55 °C to 150 °C	°C

Electrical and Thermal Characteristics (@ T_A = 25 °C Unless Otherwise Noted)

Parameter	Symbol	CD143A-SR2.8	CD143A-SR3.3	Unit
Breakdown Voltage Minimum @ 2 μA ²	V _{BR}	3.0	3.5	V
Working Peak Voltage ²	V _{WM}	2.8	3.3	V
Snap-Back Voltage Minimum @ 50 mA	V _{SB}	2.8	3.3	V
Clamping Voltage Maximum @ I _p = 1 A ^{2,3}	V _C	5.0	7.0	V
Clamping Voltage Maximum @ I _p ^{2,3}	V _C	8.5 @ 5 A	15 @ 10 A	V
Reverse Leakage Current Maximum @ V _{WM} ²	I _L	5.0		μA
Forward Voltage Maximum @ 15 mA	V _f	1.0		V
Leakage Current @ V _{WM} ⁴	I _D	1.0		μA
Capacitance Typical @ 0 V, 1 MHz ⁴	C _J	4.5		pF
ESD Protection per IEC 61000-4-2 Minimum Contact Discharge Minimum Air Discharge	ESD	+/-8 +/-15		kV
EFT Protection per IEC 61000-4-4 @ 5/50ns	EFT	40		A
Surge Protection per IEC 61000-4-5 @ 8/20 μs	Surge	12		A

Notes:

1. See Peak Pulse Power vs. Pulse Time.
2. From Pin 4 to Pin 1.
3. See Pulse Wave Form.
4. From Pin 1 to Pin 3, Pin 1 to Pin 2

* RoHS Directive 2002/95/EC Jan 27, 2003 including Annex.

** Bourns follows the prevailing definition of "halogen free" in the industry. Bourns considers a product to be "halogen free" if (a) the Bromine (Br) content is 900 ppm or less; (b) the Chlorine (Cl) content is 900 ppm or less; and (c) the total Bromine (Br) and Chlorine (Cl) content is 1500 ppm or less.

Specifications are subject to change without notice.

Customers should verify actual device performance in their specific applications.

CD143A-SR2.8~3.3 – Steering/TVS Diode Array Series



Product Dimensions

This is a molded JEDEC SOT-143 device. It weighs approximately 35 mg and has a flammability rating of UL 94V-0. The dimensions for the packaged device are shown below.

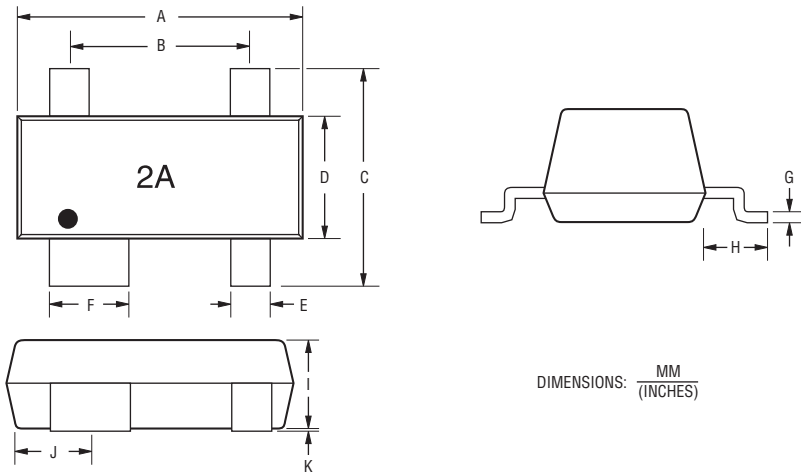

DIMENSIONS: $\frac{\text{MM}}{\text{(INCHES)}}$

Dimensions	
A	$\frac{2.80 - 3.04}{(0.110 - 0.12)}$
B	$\frac{1.78 - 2.03}{(0.070 - 0.080)}$
C	$\frac{2.11 - 2.48}{(0.083 - 0.098)}$
D	$\frac{1.20 - 1.39}{(0.047 - 0.055)}$
E	$\frac{0.39 - 0.50}{(0.015 - 0.020)}$
F	$\frac{0.79 - 0.93}{(0.031 - 0.037)}$
G	$\frac{0.08 - 0.15}{(0.003 - 0.006)}$
H	$\frac{0.46 - 0.60}{(0.018 - 0.024)}$
I	$\frac{0.84 - 1.14}{(0.033 - 0.045)}$
J	$\frac{0.72 - 0.83}{(0.028 - 0.033)}$
K	$\frac{0.013 - 0.10}{(0.0005 - 0.004)}$

Recommended Pad Layout

This is the footprint recommended for this SOT-143 device.

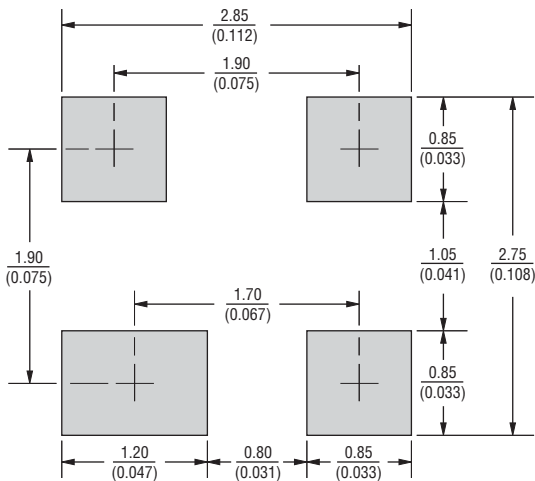

DIMENSIONS: $\frac{\text{MM}}{\text{(INCHES)}}$

Block Diagram

The device block diagram below includes the pin names and basic electrical connections associated with each channel.

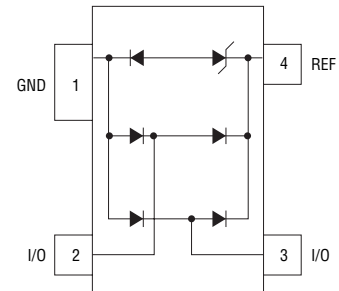

Typical Part Marking

CD143A-SR2.82A
 CD143A-SR3.33A

CD143A-SR2.8~3.3 – Steering/TVS Diode Array Series



Performance Graphs

Pulse Wave Form

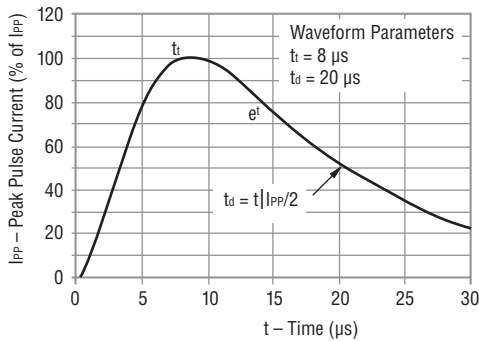

Clamping Voltage vs. Peak Pulse Current

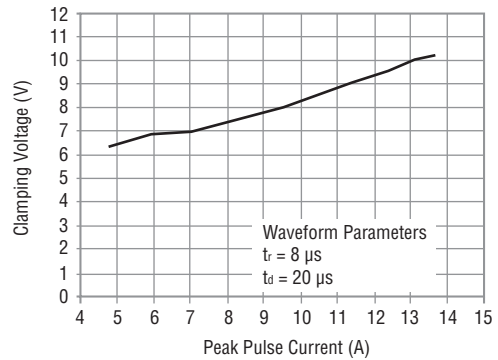

Forward Clamping Voltage vs. Peak Pulse Current

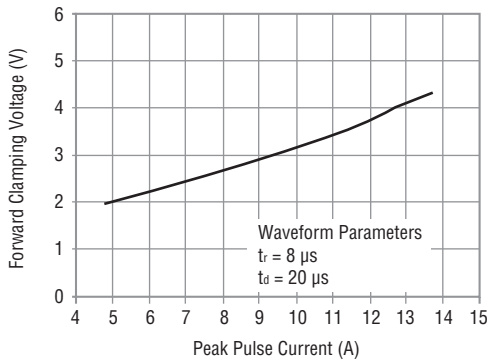

Typical Variation of C_IN vs. V_IN

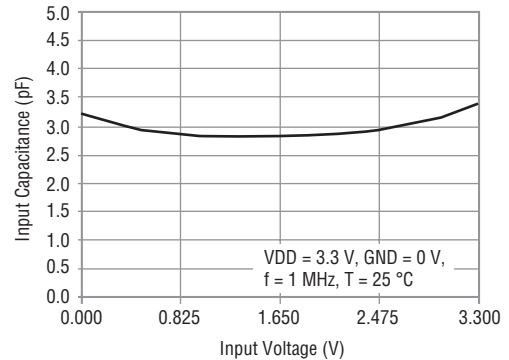

Typical Variation of C_I/O-to-I/O vs. V_IN

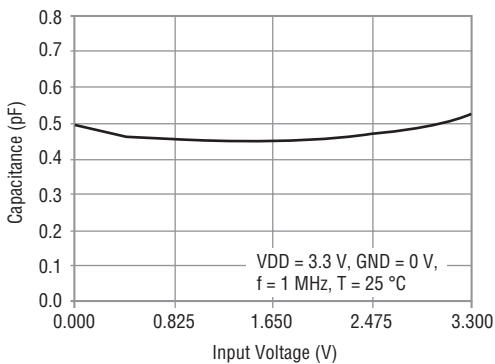

How To Order

CD 143A - SR 2.8

Common Code _____
 Chip Diode _____

Package _____
 • 143A = SOT-143

Model _____
 SR = Steering Diode Array

Repetitive Peak Reverse Voltage _____
 2.8 = 2.8 V_{RWM} (Volts)
 3.3 = 3.3 V_{RWM} (Volts)

CD143A-SR2.8~3.3 – Steering/TVS Diode Array Series

BOURNS®

Packaging Information

The surface mount product is packaged in an 8 mm x 4 mm tape and reel format per EIA-481 standard.

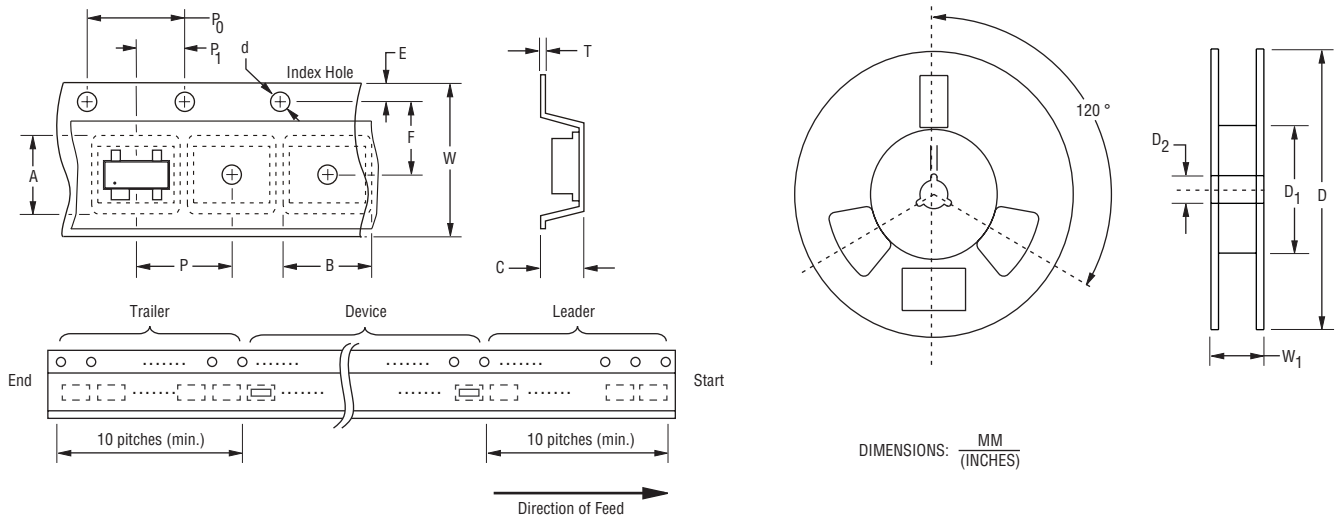

Item	Symbol	SOT-143
Carrier Width	A	$\frac{2.75 \pm 0.10}{(0.108 - 0.004)}$
Carrier Length	B	$\frac{3.30 \pm 0.10}{(0.130 - 0.004)}$
Carrier Depth	C	$\frac{1.25 \pm 0.10}{(0.049 - 0.004)}$
Sprocket Hole	d	$\frac{1.55 \pm 0.05}{(0.061 - 0.002)}$
Reel Outside Diameter	D	$\frac{178}{(7.008)}$
Reel Inner Diameter	D ₁	$\frac{50.0}{(1.969)}$ Min.
Feed Hole Diameter	D ₂	$\frac{13.0 \pm 0.20}{(0.512 - 0.008)}$
Sprocket Hole Position	E	$\frac{1.75 \pm 0.10}{(0.069 - 0.004)}$
Punch Hole Position	F	$\frac{3.50 \pm 0.05}{(0.138 - 0.002)}$
Punch Hole Pitch	P	$\frac{4.00 \pm 0.10}{(0.157 - 0.004)}$
Sprocket Hole Pitch	P ₀	$\frac{4.00 \pm 0.10}{(0.157 - 0.004)}$
Embossment Center	P ₁	$\frac{2.00 \pm 0.05}{(0.079 - 0.002)}$
Overall Tape Thickness	T	$\frac{0.20 \pm 0.10}{(0.008 - 0.004)}$
Tape Width	W	$\frac{8.00 \pm 0.20}{(0.315 - 0.008)}$
Reel Width	W ₁	$\frac{14.4}{(0.567)}$ Max.
Quantity per Reel	—	3,000

BOURNS®

Asia-Pacific:

Tel: +886-2 2562-4117 • Fax: +886-2 2562-4116

Europe:

Tel: +41-41 768 5555 • Fax: +41-41 768 5510

The Americas:

Tel: +1-951 781-5500 • Fax: +1-951 781-5700

www.bourns.com