

B7 LF Series

10 To 15 Watt Isolated DC-DC Converter

Single / Dual Output

1 . Features

- Wide 2 : 1 Input Range
- Low Ripple And Noise
- Input / Output Isolation 1.5K Vdc Or 3K Vdc
- 100% Burn-In
- Input Filter With Internal Capacitor
- Custom Design Available
- Net Weight : 24 g / 36.5 g Typical
- RoHS Converter Certified By SGS

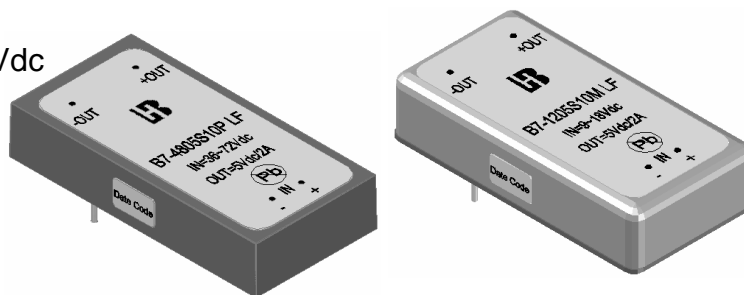

2 . Model Selection Guide

(Specifications typical at Ta= +25 , Nominal input voltage, Rated output current unless otherwise noted)

Model No.	Input Voltage (Vdc)	Output Voltage (Vdc)	Output Current (mA) Max	Input Current @No Load (mA) Typ.	Input Current @Max. Load (mA) Typ.	Output Ripple (mV) Max.	Load Regulation (%)Max.	Efficiency (%)Typ.
1) 10 W Single Output Series								
B7-123R3S10 LF	9~18	3.3	3000	20	1044	50	± 0.5	79
B7-1205S10 LF		5.0	2000	25	1042	50	± 0.5	80
B7-2405S10 LF	18~36	5	2000	13	514	50	± 0.5	81
B7-2412S10 LF		12	833	15	669	100	± 0.5	83
B7-4805S10 LF	36~72	5	2000	7	260	50	± 0.5	80
2) 15 W Single Output Series								
B7-1205S15 LF	9~18	5	3000	22	1582	50	± 0.5	79
B7-1212S15 LF		12	1250	30	1543	100	± 0.5	81
B7-2405S15 LF	18~36	5	3000	17	781	50	± 0.5	80
B7-2412S15 LF		12	1250	20	762	100	± 0.5	82
B7-4805S15 LF	36~72	5	3000	12	396	50	± 0.5	79
B7-4812S15 LF		12	1250	15	381	100	± 0.5	82
3) 10 W Dual Output Series								
B7-1205D10 LF	9~18	± 5	± 1000	27	1068	50	± 2	78
B7-2405D10 LF	18~36	± 5	± 1000	18	527	50	± 2	79
B7-2415D10 LF		± 15	± 333	20	661	120	± 2	82
B7-4805D10 LF	36~72	± 5	± 1000	12	260	50	± 2	80
B7-4815D10 LF		± 15	± 333	15	254	120	± 2	80
4) 15 W Dual Output Series								
B7-1205D15 LF	9~18	± 5	± 1500	27	1603	50	± 2	78
B7-1212D15 LF		± 12	± 625	32	1563	100	± 2	80



B7 LF Series

10 To 15 Watt Isolated DC-DC Converter

Single / Dual Output

B7-2405D15 LF	18~36	± 5	± 1500	20	791	50	± 2	79
B7-2412D15 LF		± 12	± 625	22	772	100	± 2	81
B7-4805D15 LF	36~72	± 5	± 1500	12	396	50	± 2	79
B7-4815D15 LF		± 15	± 500	15	381	120	± 2	82

Notes :

1. B7-xxxxSxx or B7-xxxxDxx is for customer design.
2. Load regulation is for output current change from 0% to 100% Max. load.

3 . Absolute Maximum Ratings

(Exceeding these values may damage the module. These are not continuous operating ratings)

Parameter	Condition	Min.	Typ.	Max.	Unit
Input Absolute Voltage Range	12V Input Model	-0.7	12	22.5	Vdc
	24V Input Model	-0.7	24	45	
	48V Input Model	-0.7	48	90	
Output Short Circuit Duration	Nominal Input Range	Indefinite & Auto-Restart			
Reverse Polarity Input Current Limit	---	---	---	1	A
Operation Temperature (Ambient Temperature)	Output Full Load	-25	---	+71	
Storage Temperature		-55	---	+105	

4 . Nominal Input/Output Electrical Specifications

(Specifications typical at Ta= +25 , Nominal input voltage, Rated output current unless otherwise noted)

Parameter	Condition	Min.	Typ.	Max.	Unit
Input Voltage Range	12V Input Model	9	12	18	Vdc
	24V Input Model	18	24	36	
	48V Input Model	36	48	72	
Line Regulation	Output Full Load	---	---	± 0.5	%
Load Regulation	Single Output Model	---	---	± 0.5	
	Dual Output Model	---	---	± 2	
Output Voltage Accuracy	Nominal Input	---	± 1.0	± 2.0	
Output Voltage Balance	Dual Output At Same Load	---	---	± 1.0	
Switching Frequency	Nominal Input	---	250	---	KHz
Temperature Coefficient		---	± 0.01	± 0.02	% /
Isolation Voltage	Standard Series	1500	---	---	Vdc
	High Isolation Series	3000	---	---	
Isolation Resistance	500 Vdc	1000	---	---	M
Isolation Capacitance	1KHz / 250mV rms	---	350	---	pF



5 . General Specification

Parameter	Specification	Condition
Isolation Voltage	1500 / 3000 Vdc	Test Duration 60 Seconds / 0.5 mA
Isolation Resistance	1000 M Min.	@ 500 Vdc
Operating Temperature (1)	-25 ~ +71	@ Ambient Temperature With Natural Convention
Operating Temperature (2)	-25 ~ +95	@ Case Surface Temperature
Storage Temperature	-55 ~ +105	---
Humidity	Up To 90 %	---
Cooling	Free Air Convection	---
Case Type	Plastic, Metal	---

6 . Ordering Information

7 . Power Derating Curve

Temperature derating graph

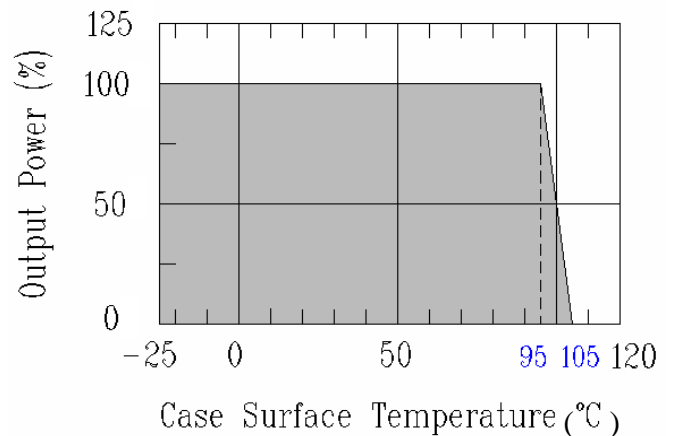
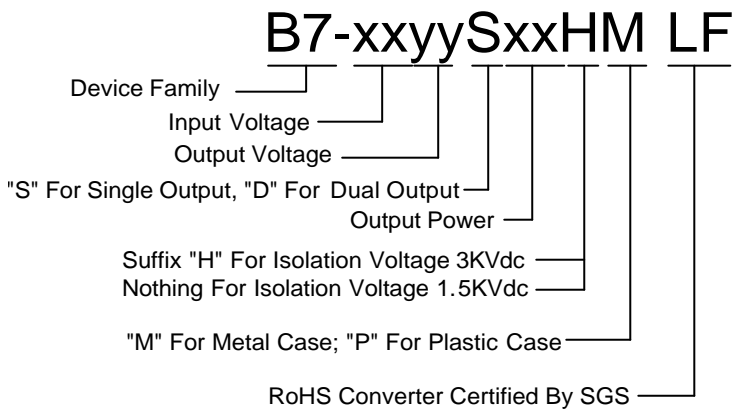

8 . Efficiency & Output Load Chart

Vout = 5 Vdc

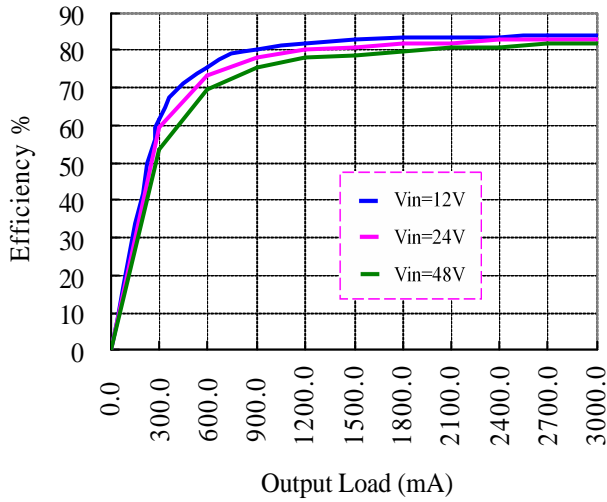

Vout = 12 Vdc

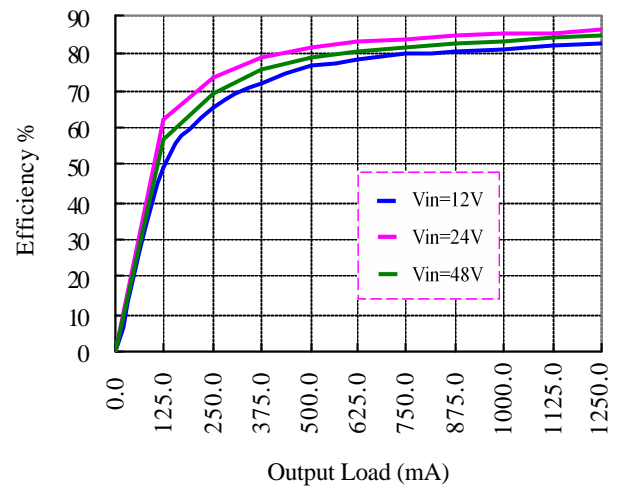

Vout = 15 Vdc

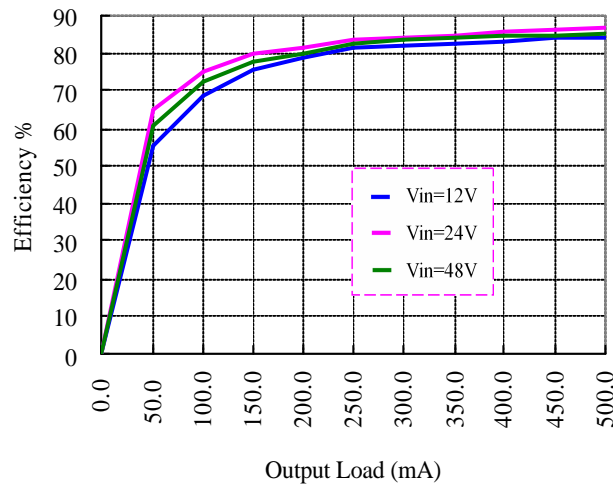

9 . Mechanical Dimension

Single Output Metal Case Model

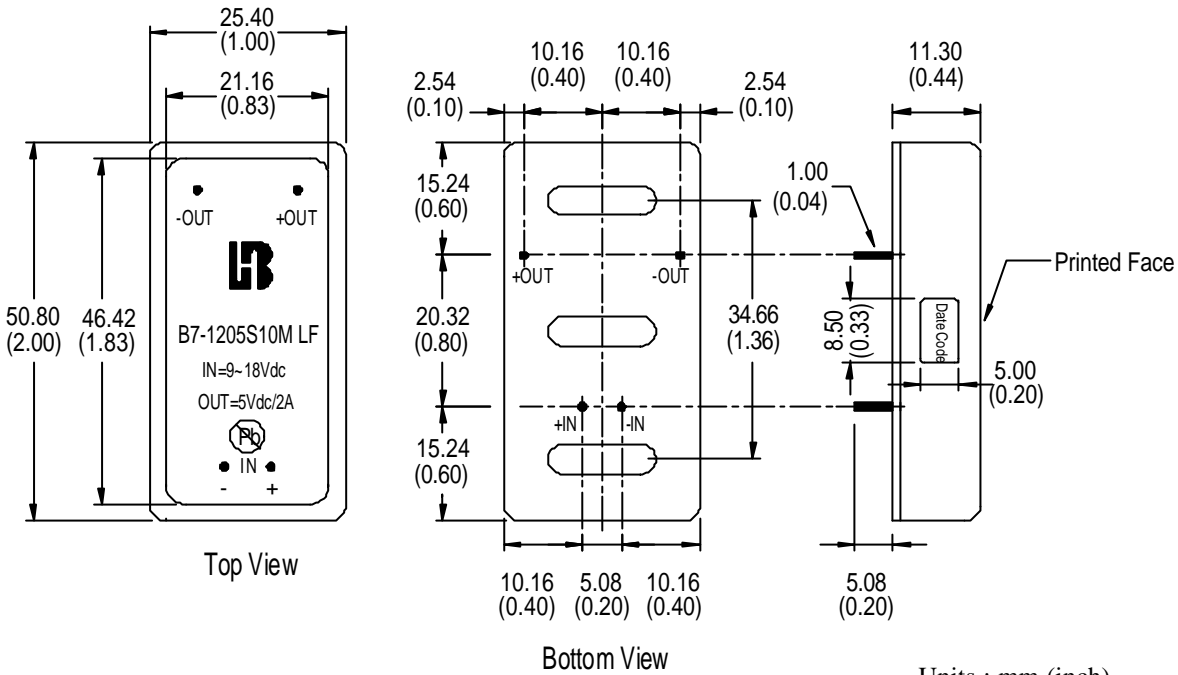

Units : mm (inch)
Tolerance : 0.xx ± 0.25 (0.xx ± 0.01)

Dual Output Metal Case Model

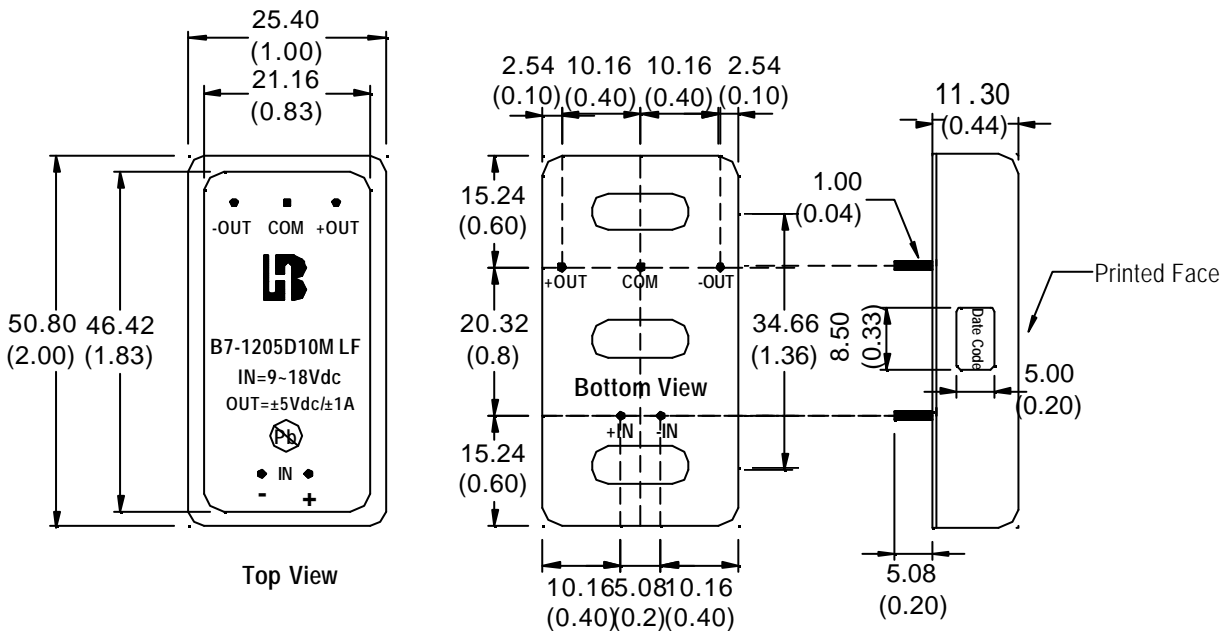

Units : mm (inch)
Tolerance : 0.xx ± 0.25 (0.xx ± 0.01)

Single Output Plastic Case Model

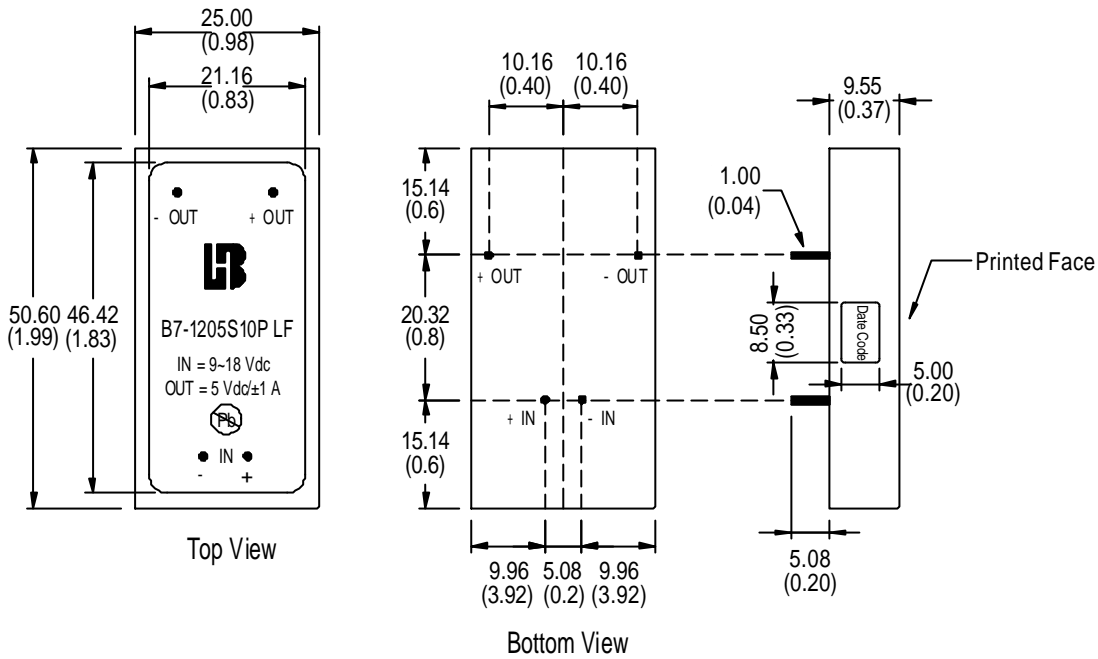

Units : mm (inch)

Tolerance : 0.xx ± 0.25 (0.xx ± 0.01)

Dual Output Plastic Case Model

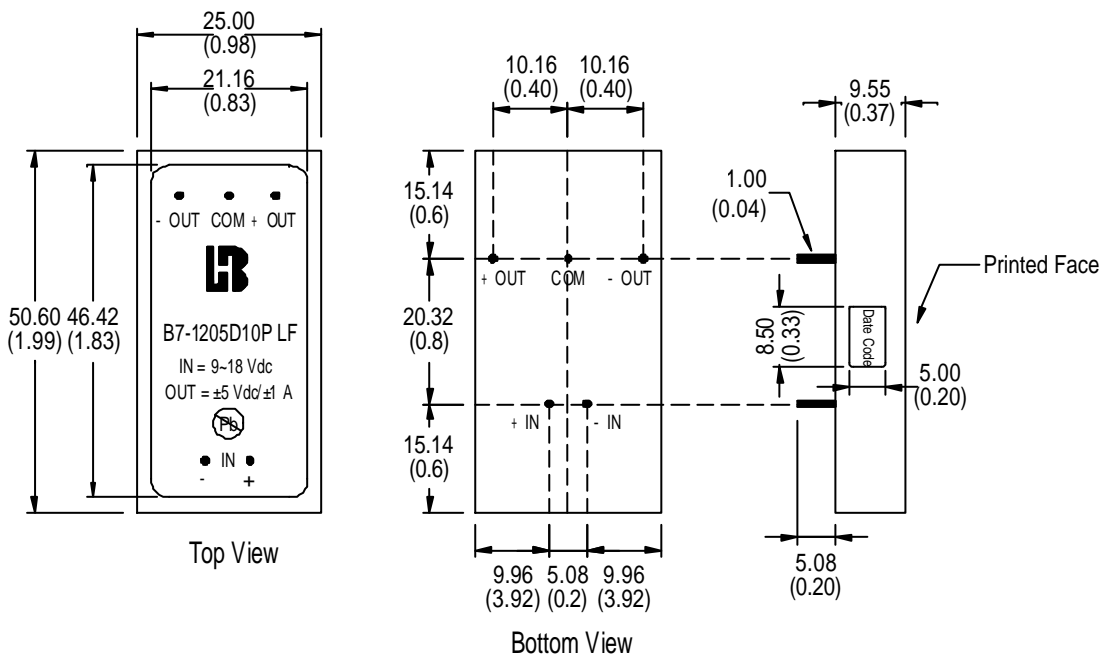

Units : mm (inch)

Tolerance : 0.xx ± 0.25 (0.xx ± 0.01)

10 . Recommended Footprint Details

Single Output Metal Case

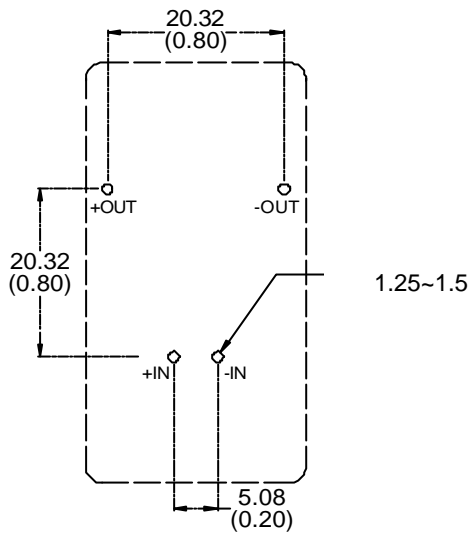

Dual Output Metal Case

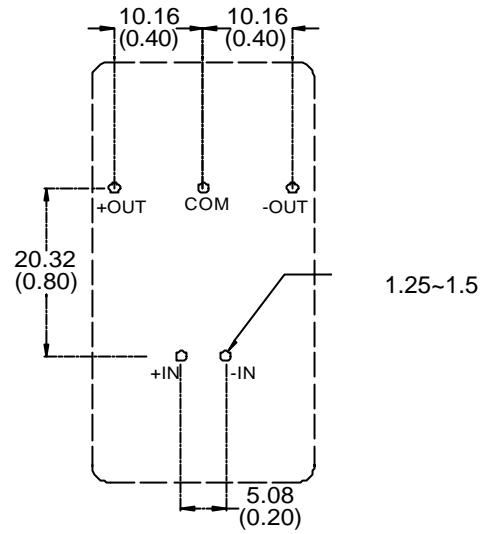

Units : mm (inch)
Tolerance : 0.xx ± 0.25 (0.xx ± 0.01)

Single Output Plastic Case

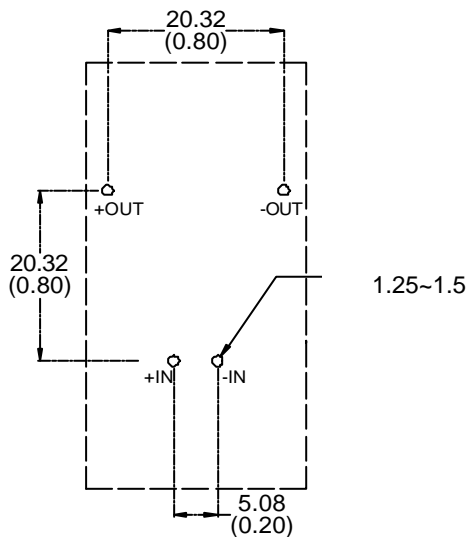

Dual Output Plastic Case

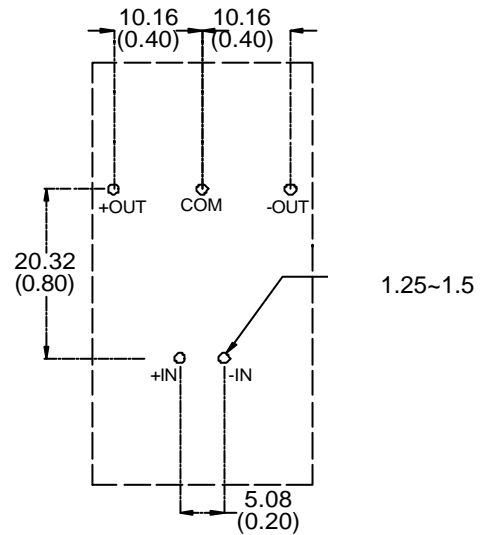

Units : mm (inch)
Tolerance : 0.xx ± 0.25 (0.xx ± 0.01)

11 . Package

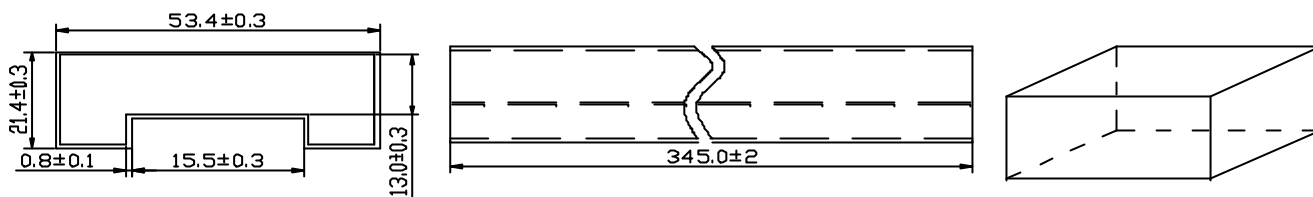

TUBE MECHANICAL DIMENSION

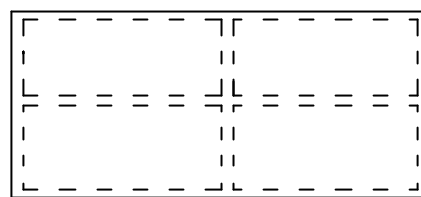
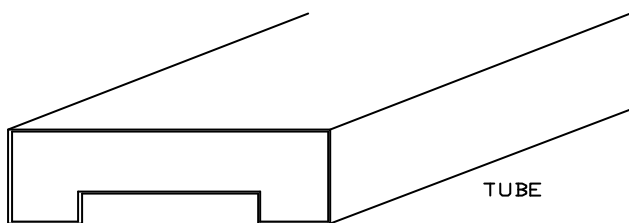

EXPORT CARTON:405*334*263

1. TUBE=12PCS
2. INNER CARTON=9 TUBE=9*12=108PCS
3. EXPORT CARTON= 4 INNER CARTON=4*108=432PCS