



82NXX

CMOS IC

VOLTAGE DETECTORS

DESCRIPTION

The UTC **82NXX** series are highly precise, low power consumption voltage detectors. Detect voltage is extremely accurate with minimal temperature drift. N-channel open drain output configurations are available.

FEATURES

- * High-accuracy detection voltage : $\pm 2\%$
- * Detect voltage range : 0.9V to 6.0V in 0.1V increments
- * Detect voltage temperature characteristics: TYP. $\pm 100\text{ppm}/^\circ\text{C}$
- * Wide operating voltage range : 0.7V to 10.0V
- * Low current consumption : TYP 0.7 μA (at $V_{\text{IN}}=1.5\text{V}$)

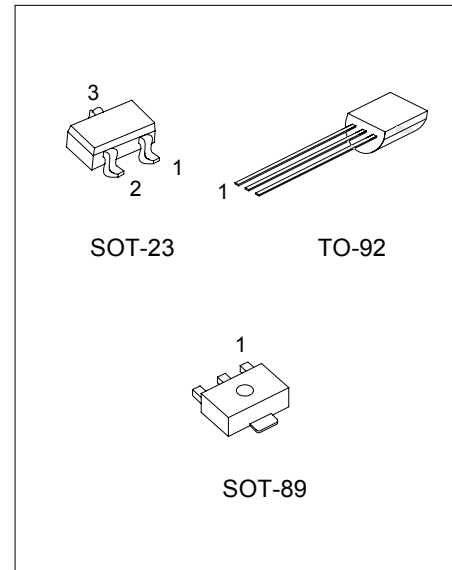

*Pb-free plating product number: 82NXXL

ORDERING INFORMATION

Order Number		Package	Pin assignment			Packing
Normal	Lead Free Plating		1	2	3	
82Nxx-AB3-D-R	82NxxL-AB3-D-R	SOT-89	I	G	O	Tape Reel
82Nxx-AB3-E-R	82NxxL-AB3-E-R	SOT-89	O	I	G	Tape Reel
82Nxx-AE3-5-R	82NxxL-AE3-5-R	SOT-23	G	O	I	Tape Reel
82Nxx-T92-D-B	82NxxL-T92-D-B	TO-92	I	G	O	Tape Box
82Nxx-T92-D-K	82NxxL-T92-D-K	TO-92	I	G	O	Bulk
82Nxx-T92-E-B	82NxxL-T92-E-B	TO-92	O	I	G	Tape Box
82Nxx-T92-E-K	82NxxL-T92-E-K	TO-92	O	I	G	Bulk

Note: 1. Pin assignment: I:Vin O:Vout G:Vss
 2.xx: Output Voltage, refer to Marking Information

<p>82NxxL-AB3-D-R</p>	<p>(1)Packing Type (2)Pin Assignment (3)Package Type (4)Lead Plating (5)Output Voltage Code</p>	<p>(1) B: Tape Box, K: Bulk, R: Tape Reel (2) refer to Pin Assignment (3) AB3: SOT-89, AE3: SOT-23, T92: TO-92 (4) L: Lead Free Plating, Blank: Pb/Sn (5) xx: refer to Marking Information</p>
-----------------------	---	--

MARKING INFORMATION

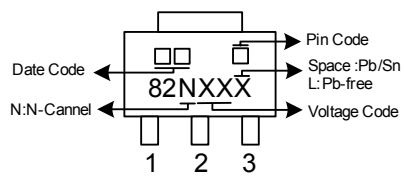
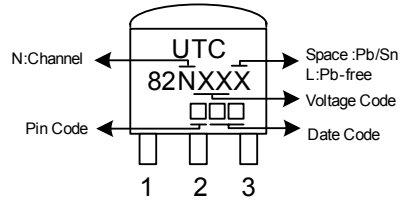
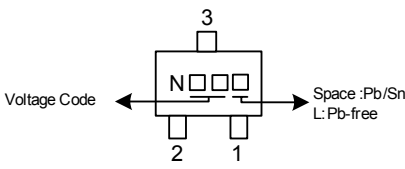
PACKAGE	VOLTAGE CODE		MARKING		
SOT-89	09:0.9V	27:2.7V			
	10:1.0V	28:2.8V			
	11:1.1V	29:2.9V			
	12:1.2V	30:3.0V			
	13:1.3V	31:3.1V			
	14:1.4V	32:3.2V			
	15:1.5V	33:3.3V			
	16:1.6V	34:3.4V			
	17:1.7V	35:3.5V			
	18:1.8V	36:3.6V			
	19:1.9V	37:3.7V			
	20:2.0V	38:3.8V			
	21:2.1V	39:3.9V			
	TO-92	22:2.2V		40:4.0V	
23:2.3V		41:4.1V			
24:2.4V		42:4.2V			
25:2.5V		43:4.3V			
26:2.6V		44:4.4V			
45:4.5V					
SOT-23					

MARKING CODE FOR SOT-23

PART NUMBER	DETECT VOLATGE		MARKING CODE	PART NUMBER	DETECT VOLATGE		MARKING CODE
	VOLTAGE	CODE			VOLTAGE	CODE	
82N09	0.9V	09	N09	82N30	3.0V	30	N30
82N10	1.0V	10	N10	82N31	3.1V	31	N31
82N11	1.1V	11	N11	82N32	3.2V	32	N32
82N12	1.2V	12	N12	82N33	3.3V	33	N33
82N13	1.3V	13	N13	82N34	3.4V	34	N34
82N14	1.4V	14	N14	82N35	3.5V	35	N35
82N15	1.5V	15	N15	82N36	3.6V	36	N36
82N16	1.6V	16	N16	82N37	3.7V	37	N37
82N17	1.7V	17	N17	82N38	3.8V	38	N38
82N18	1.8V	18	N18	82N39	3.9V	39	N39
82N19	1.9V	19	N19	82N40	4.0V	40	N40
82N20	2.0V	20	N20	82N41	4.1V	41	N41
82N21	2.1V	21	N21	82N42	4.2V	42	N42
82N22	2.2V	22	N22	82N43	4.3V	43	N43
82N23	2.3V	23	N23	82N44	4.4V	44	N44
82N24	2.4V	24	N24	82N45	4.5V	45	N45
82N25	2.5V	25	N25				
82N26	2.6V	26	N26				
82N27	2.7V	27	N27				
82N28	2.8V	28	N28				
82N29	2.9V	29	N29				

■ BLOCK DIAGRAM

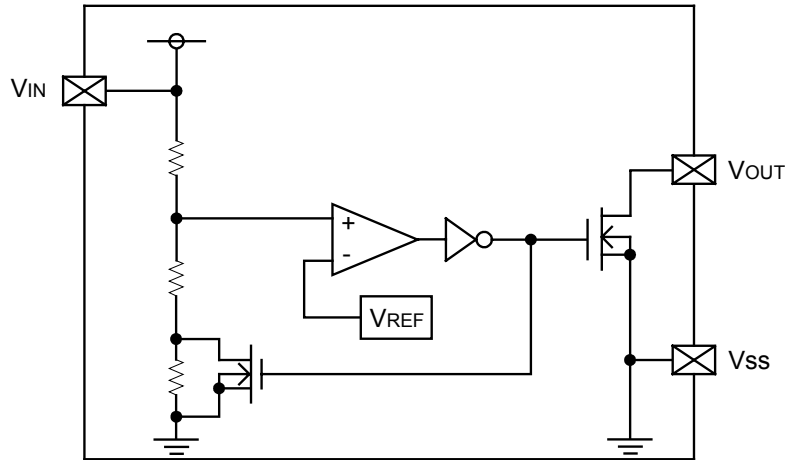

■ TYPICAL APPLICATION CIRCUIT

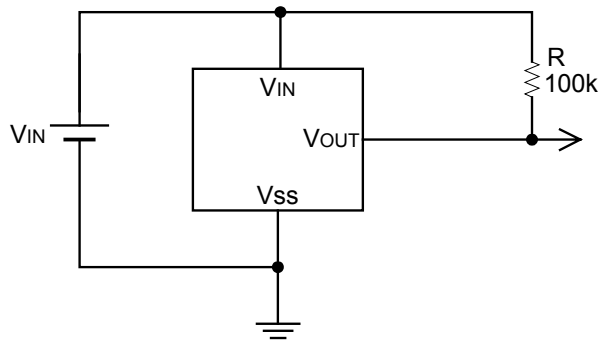

■ ABSOLUTE MAXIMUM RATINGS (Ta=25 , unless otherwise specified)

PARAMETER	SYMBOL	RATINGS	UNIT
Input Voltage	V _{IN}	12	V
Output Current	I _{OUT}	50	mA
Output Voltage	V _{OUT}	V _{SS} -0.3 ~ V _{IN} +0.3	V
Power Dissipation	SOT-23	150	mW
	SOT-89	500	
	TO-92	300	
Operating Temperature	T _{OPR}	-40 ~ +85	
Storage Temperature	T _{STG}	-40 ~ +150	

Note: 1. Absolute maximum ratings are those values beyond which the device which the device could be permanently damaged. Absolute maximum ratings are stress ratings only and functional device operation is not implied.

2. The device is guaranteed to meet performance specification within 0 ~ +70 operating temperature range and assured by design from -40 ~ +85 , characteristic and correlation with static process control.

■ ELECTRICAL CHARACTERISTICS (Ta=25 , unless otherwise specified.)

Detection voltage (0.9V)

PARAMETER	SYMBOL	CIRCUIT	TEST CONDITONS	MIN	TYP	MAX.	UNIT
Detect Voltage (Note1)	V _{DF}	1		V _{DF} ×0.98	V _{DF} (note2)	V _{DF} ×1.02	V
Hysteresis Range	V _{HYS}	1		V _{DF} ×0.02	V _{DF} ×0.05	V _{DF} ×0.08	V
Supply Current	I _{SS}	2	V _{IN} =1.5V		0.7	2.3	μA
			V _{IN} =5V		1.1	3.6	μA
Operating Voltage	V _{IN}	1		0.7		6.0	V
Output Current	I _{OUT}	3	V _{DS} =0.5V, V _{IN} =0.7V	0.1	0.8		mA
Temperature Characteristics	$\frac{V_{DF}}{T_{OPR} \cdot V_{DF}}$		-40 ≤ T _{OPR} ≤ 85		±100		ppm/
Transient Delay Time	t _{DLY}	4				0.2	ms

Detection voltage (1.0V ~ 1.5V)

PARAMETER	SYMBOL	CIRCUIT	TEST CONDITONS	MIN	TYP	MAX.	UNIT
Detect Voltage (Note1)	V _{DF}	1		V _{DF} ×0.98	V _{DF} (note2)	V _{DF} ×1.02	V
Hysteresis Range	V _{HYS}	1		V _{DF} ×0.02	V _{DF} ×0.05	V _{DF} ×0.08	V
Supply Current	I _{SS}	2	V _{IN} =1.5V		0.7	2.3	μA
			V _{IN} =5V		1.1	3.6	μA
Operating Voltage	V _{IN}	1		0.7		6.0	V
Output Current	I _{OUT}	3	V _{DS} =0.5V, V _{IN} =1.0V	0.85	2.7		mA
Temperature Characteristics	$\frac{V_{DF}}{T_{OPR} \cdot V_{DF}}$		-40 ≤ T _{OPR} ≤ 85		±100		ppm/
Transient Delay Time	t _{DLY}	4				0.2	ms

Detection voltage (1.6V ~ 1.9V)

PARAMETER	SYMBOL	CIRCUIT	TEST CONDITONS	MIN	TYP	MAX.	UNIT
Detect Voltage(Note1)	V _{DF}	1		V _{DF} ×0.98	V _{DF} (note2)	V _{DF} ×1.02	V
Hysteresis Range	V _{HYS}	1		V _{DF} ×0.02	V _{DF} ×0.05	V _{DF} ×0.08	V
Supply Current	I _{SS}	2	V _{IN} =1.5V		0.7	2.3	μA
			V _{IN} =5V		1.1	3.6	μA
Operating Voltage	V _{IN}	1		0.7		10	V
Output Current	I _{OUT}	3	V _{DS} =0.5V, V _{IN} =1.0V	1.0	2.2		mA
Temperature Characteristics	$\frac{V_{DF}}{T_{OPR} \cdot V_{DF}}$		-40 ≤ T _{OPR} ≤ 85		±100		ppm/
Transient Delay Time	t _{DLY}	4				0.2	ms

■ ELECTRICAL CHARACTERISTICS(Cont.)

Detection voltage (2.0V ~ 2.4V)

PARAMETER	SYMBOL	CIRCUIT	TEST CONDITONS	MIN	TYP	MAX.	UNIT
Detect Voltage(Note1)	V_{DF}	1		$V_{DF} \times 0.98$	V_{DF} (note2)	$V_{DF} \times 1.02$	V
Hysteresis Range	V_{HYS}	1		$V_{DF} \times 0.02$	$V_{DF} \times 0.05$	$V_{DF} \times 0.08$	V
Supply Current	I_{SS}	2	$V_{IN} = 2.0V$		0.8	2.7	μA
			$V_{IN} = 5.0V$		1.1	3.6	μA
Operating Voltage	V_{IN}	1		0.7		10	V
Output Current	I_{OUT}	3	$V_{DS} = 0.5V, V_{IN} = 2.0V$	3.0	7.7		mA
Temperature Characteristics	$\frac{V_{DF}}{T_{OPR} \cdot V_{DF}}$		$-40 \leq T_{OPR} \leq 85$		± 100		ppm/
Transient Delay Time	t_{DLY}	4				0.2	ms

Detection voltage (2.5V ~ 2.9V)

PARAMETER	SYMBOL	CIRCUIT	TEST CONDITONS	MIN	TYP	MAX.	UNIT
Detect Voltage(Note1)	V_{DF}	1		$V_{DF} \times 0.98$	V_{DF} (note2)	$V_{DF} \times 1.02$	V
Hysteresis Range	V_{HYS}	1		$V_{DF} \times 0.02$	$V_{DF} \times 0.05$	$V_{DF} \times 0.08$	V
Supply Current	I_{SS}	2	$V_{IN} = 2.0V$		0.8	2.7	μA
			$V_{IN} = 5.0V$		1.1	3.6	μA
Operating Voltage	V_{IN}	1		0.7		10	V
Output Current	I_{OUT}	3	$V_{DS} = 0.5V, V_{IN} = 2.0V$	3.0	7.7		mA
Temperature Characteristics	$\frac{V_{DF}}{T_{OPR} \cdot V_{DF}}$		$-40 \leq T_{OPR} \leq 85$		± 100		ppm/
Transient Delay Time	t_{DLY}	4				0.2	ms

Detection voltage (3.0V ~ 3.4V)

PARAMETER	SYMBOL	CIRCUIT	TEST CONDITONS	MIN	TYP	MAX.	UNIT
Detect Voltage(Note1)	V_{DF}	1		$V_{DF} \times 0.98$	V_{DF} (note2)	$V_{DF} \times 1.02$	V
Hysteresis Range	V_{HYS}	1		$V_{DF} \times 0.02$	$V_{DF} \times 0.05$	$V_{DF} \times 0.08$	V
Supply Current	I_{SS}	2	$V_{IN} = 3.0V$		0.9	3.0	μA
			$V_{IN} = 5.0V$		1.1	3.6	μA
Operating Voltage	V_{IN}	1		0.7		10	V
Output Current	I_{OUT}	3	$V_{DS} = 0.5V, V_{IN} = 3.0V$	5.0	10.1		mA
Temperature Characteristics	$\frac{V_{DF}}{T_{OPR} \cdot V_{DF}}$		$-40 \leq T_{OPR} \leq 85$		± 100		ppm/
Transient Delay Time	t_{DLY}	4				0.2	ms

Detection voltage (3.5V ~ 3.9V)

PARAMETER	SYMBOL	CIRCUIT	TEST CONDITONS	MIN	TYP	MAX.	UNIT
Detect Voltage(Note1)	V_{DF}	1		$V_{DF} \times 0.98$	V_{DF} (note2)	$V_{DF} \times 1.02$	V
Hysteresis Range	V_{HYS}	1		$V_{DF} \times 0.02$	$V_{DF} \times 0.05$	$V_{DF} \times 0.08$	V
Supply Current	I_{SS}	2	$V_{IN} = 3.0V$		0.9	3.0	μA
			$V_{IN} = 5.0V$		1.1	3.6	μA
Operating Voltage	V_{IN}	1		0.7		10	V
Output Current	I_{OUT}	3	$V_{DS} = 0.5V, V_{IN} = 3.0V$	5.0	10.1		mA
Temperature Characteristics	$\frac{V_{DF}}{T_{OPR} \cdot V_{DF}}$		$-40 \leq T_{OPR} \leq 85$		± 100		ppm/
Transient Delay Time	t_{DLY}	4				0.2	ms

■ ELECTRICAL CHARACTERISTICS(Cont.)

Detection voltage (4.0V ~ 4.5V)

PARAMETER	SYMBOL	CIRCUIT	TEST CONDITONS	MIN	TYP	MAX.	UNIT
Detect Voltage(Note1)	V_{DF}	1		$V_{DF} \times 0.98$	V_{DF} (note2)	$V_{DF} \times 1.02$	V
Hysteresis Range	V_{HYS}	1		$V_{DF} \times 0.02$	$V_{DF} \times 0.05$	$V_{DF} \times 0.08$	V
Supply Current	I_{SS}	2	$V_{IN} = 4.0V$		1.0	3.2	μA
			$V_{IN} = 5.0V$		1.1	3.6	μA
Operating Voltage	V_{IN}	1		0.7		10	V
Output Current	I_{OUT}	3	$V_{DS} = 0.5V, V_{IN} = 4.0V$	6.0	11.5		mA
Temperature Characteristics	$\frac{V_{DF}}{T_{OPR} \cdot V_{DF}}$		$-40 \leq T_{OPR} \leq 85$		± 100		ppm/
Transient Delay Time	t_{DLY}	4				0.2	ms

Note 1. Detect voltage of $\pm 1\%$ tolerance is also available per customer's request.

2. $V_{DF(T)}$: Established Detect Voltage Value

■ TEST CIRCUITS

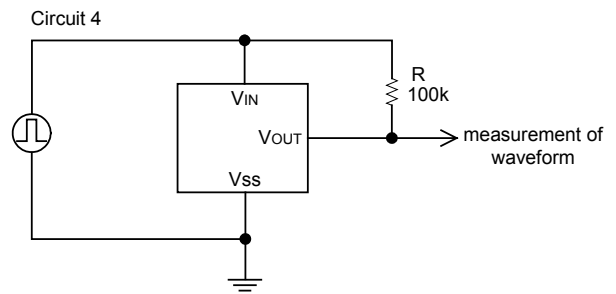
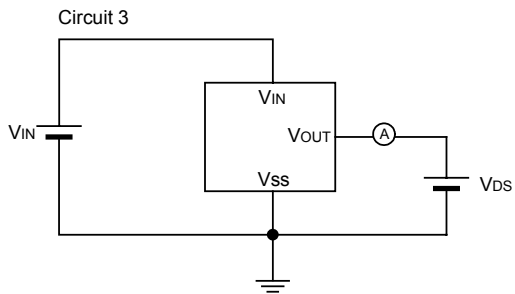
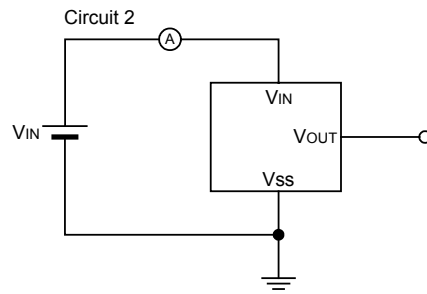
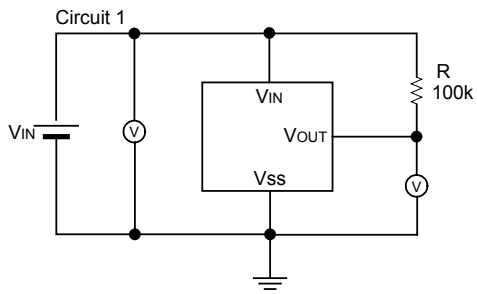

■ TIMING CHART FUNCTIONAL DESCRIPTION

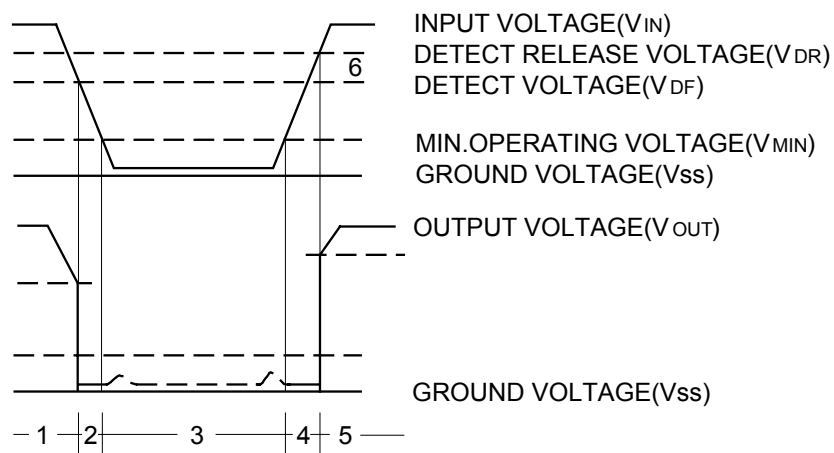

1. When input voltage (V_{IN}) rises above detect voltage (V_{DF}), output voltage (V_{OUT}) will be equal to V_{IN} .
2. When input voltage (V_{IN}) falls below detect voltage (V_{DF}), output voltage (V_{OUT}) will be equal to the ground voltage (V_{SS}) level.
3. When input voltage (V_{IN}) falls to a level below that of the minimum operating voltage (V_{MIN}), output will become unstable. In this condition, V_{IN} will equal the pulled-up output (should output be pulled-up.)
4. When input voltage (V_{IN}) rises above the ground voltage (V_{SS}) level, output will be unstable at levels below the minimum operating voltage (V_{MIN}). Between the V_{MIN} and detect release voltage (V_{DR}) levels, the ground voltage (V_{SS}) level will be maintained.
5. When input voltage (V_{IN}) rises above detect release voltage (V_{DR}), output voltage (V_{OUT}) will be equal to V_{IN} .
6. The difference between V_{DR} and V_{DF} represents the hysteresis range.

■ TYPICAL PERFORMANCE CHARACTERISTICS
 (1) DETECT, RELEASE VOLTAGE vs. AMBIENT TEMPERATURE

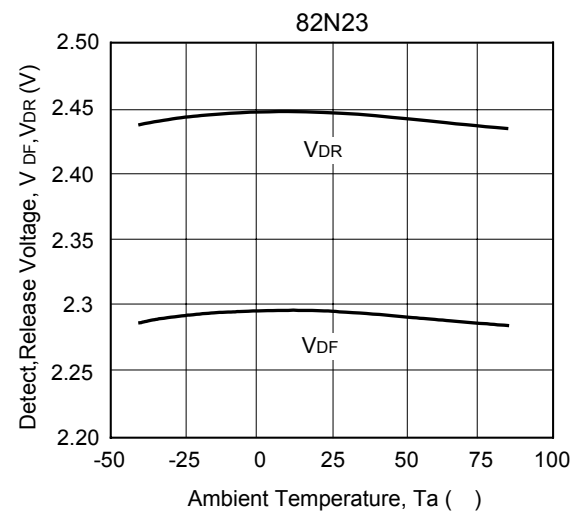
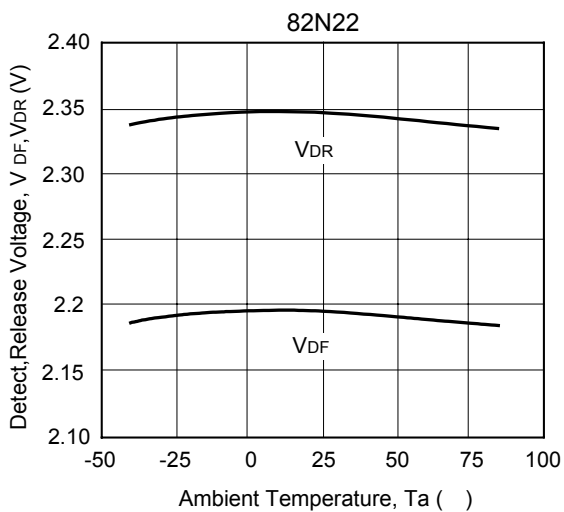
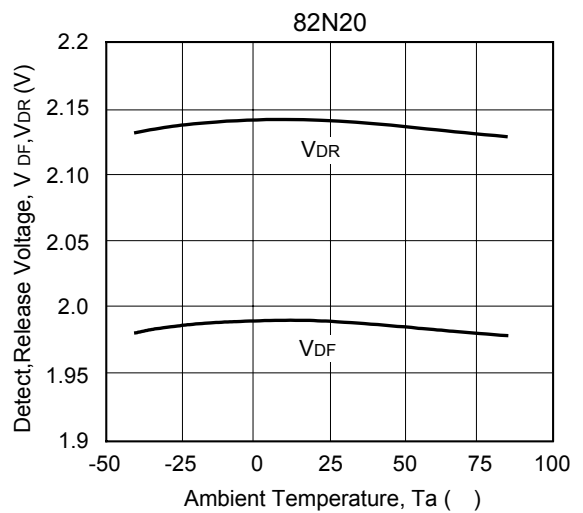
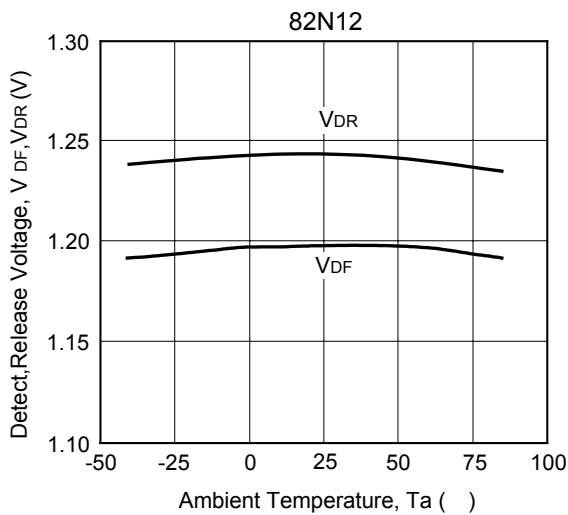
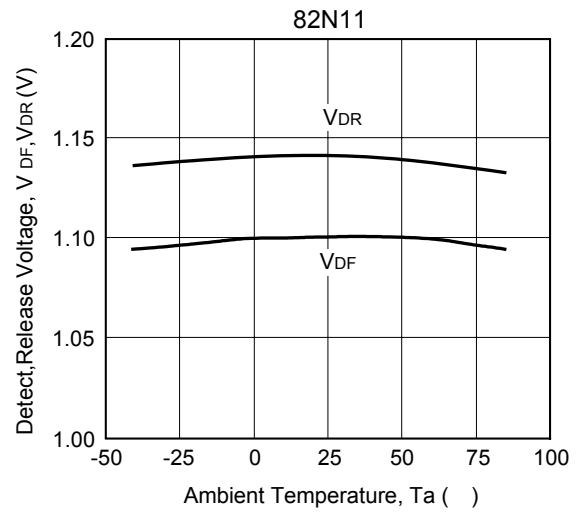
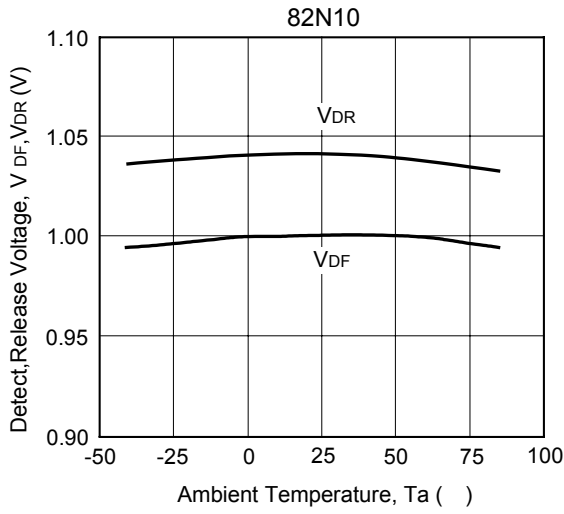

■ TYPICAL PERFORMANCE CHARACTERISTICS (Cont.)

(1) DETECT, RELEASE VOLTAGE vs. AMBIENT TEMPERATURE(Cont.)

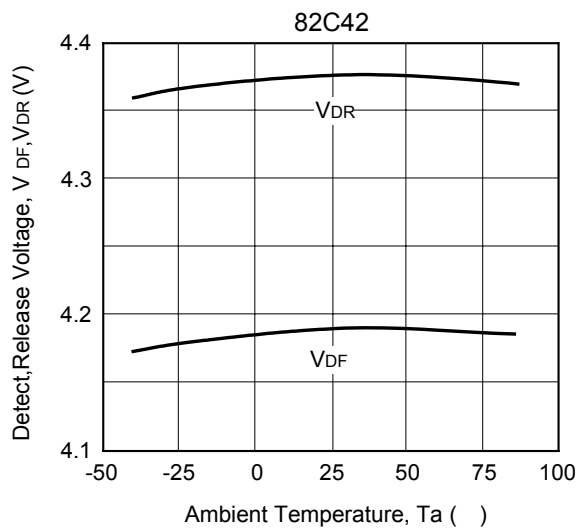
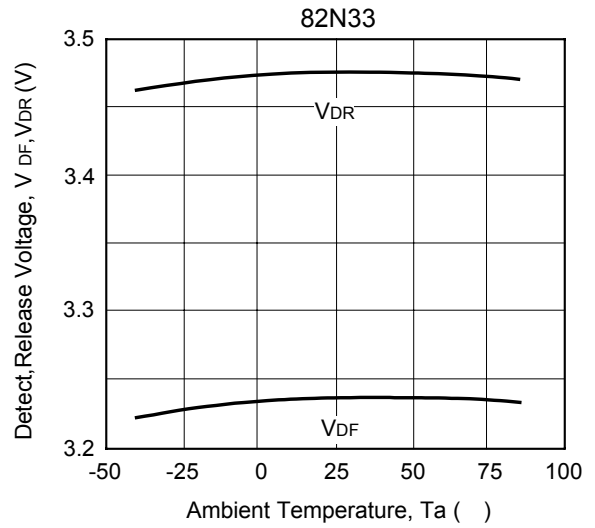
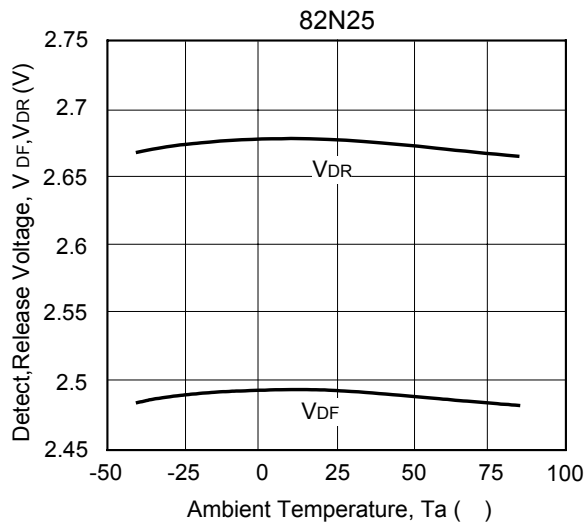

■ TYPICAL PERFORMANCE CHARACTERISTICS (Cont.)
 (2) SUPPLY CURRENT vs. INPUT VOLTAGE

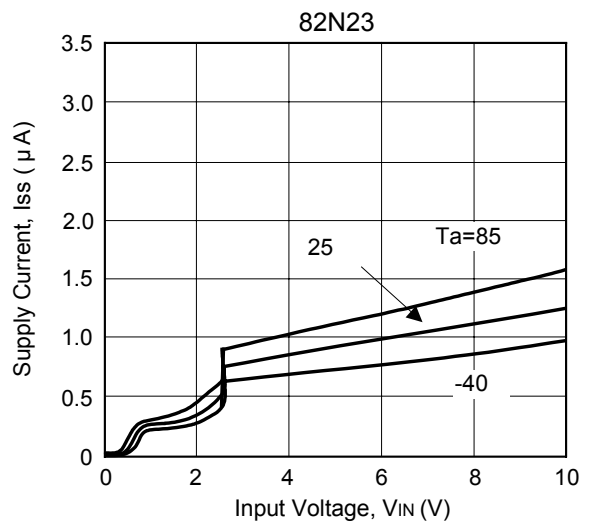
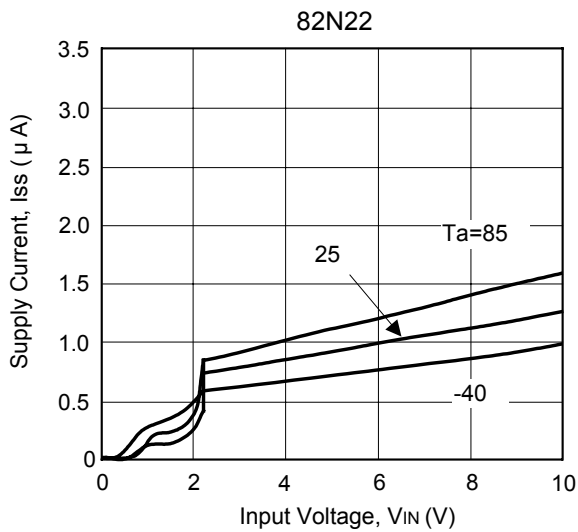
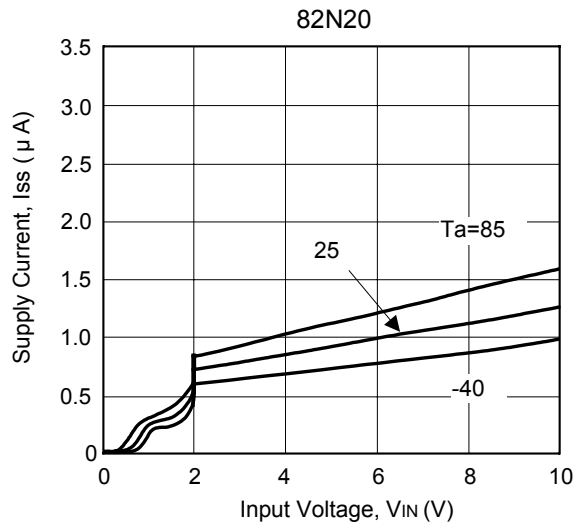
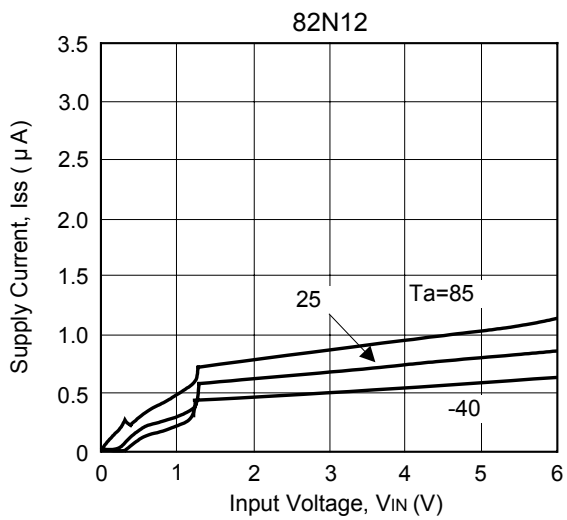
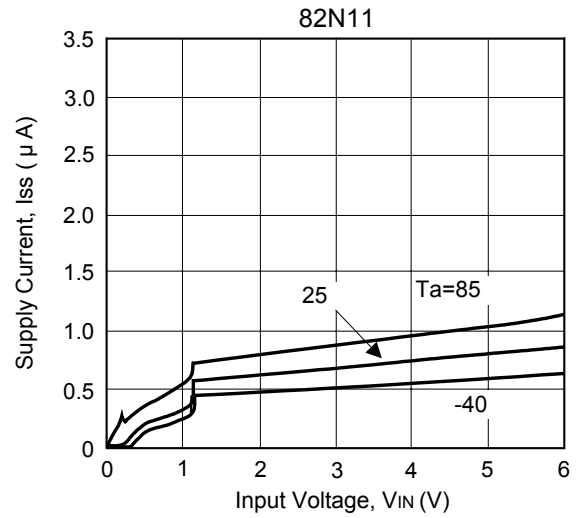
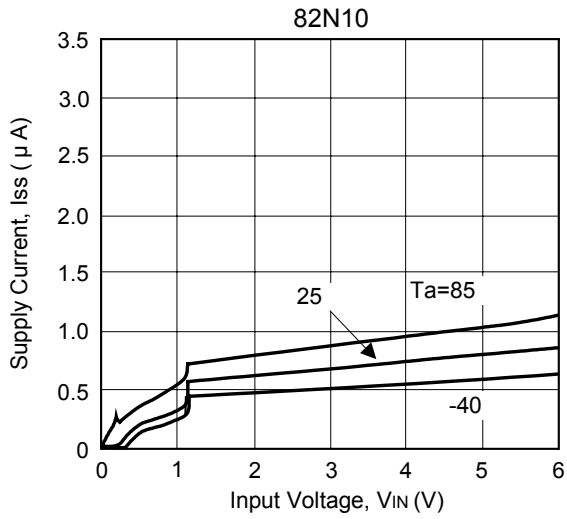

■ TYPICAL PERFORMANCE CHARACTERISTICS (Cont.)
 (2) SUPPLY CURRENT vs. INPUT VOLTAGE(Cont.)

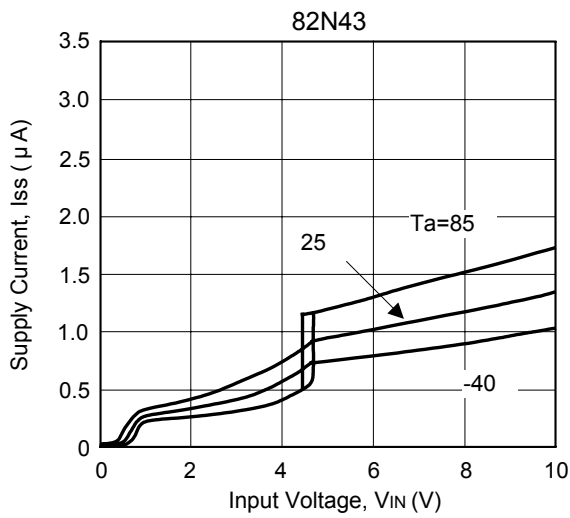
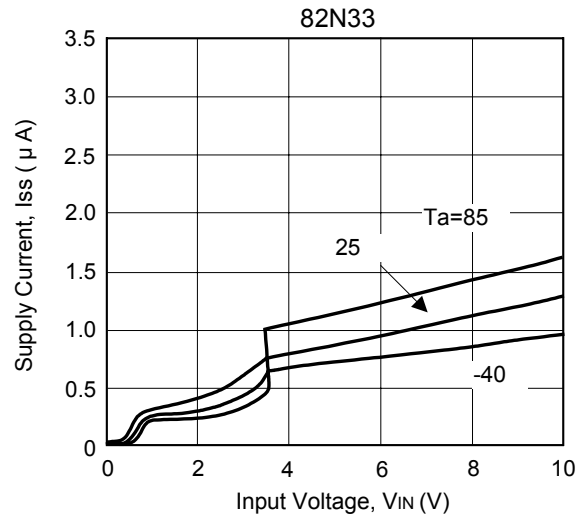
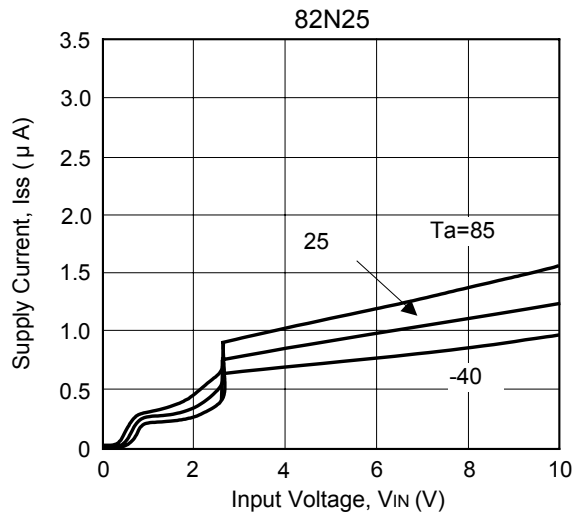

■ TYPICAL PERFORMANCE CHARACTERISTICS (Cont.) (3) DRIVER OUTPUT CURRENT vs. INPUT VOLTAGE

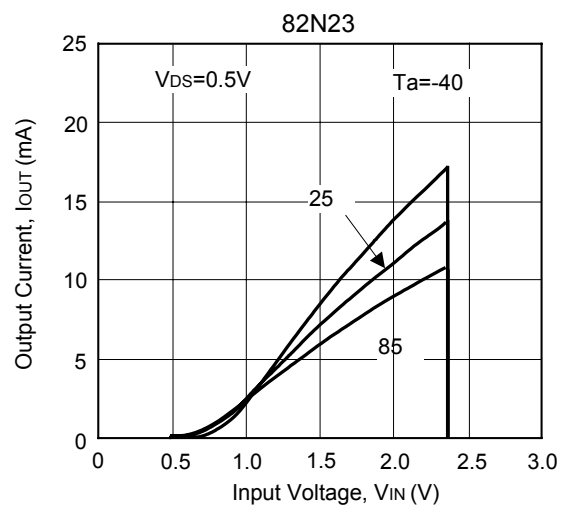
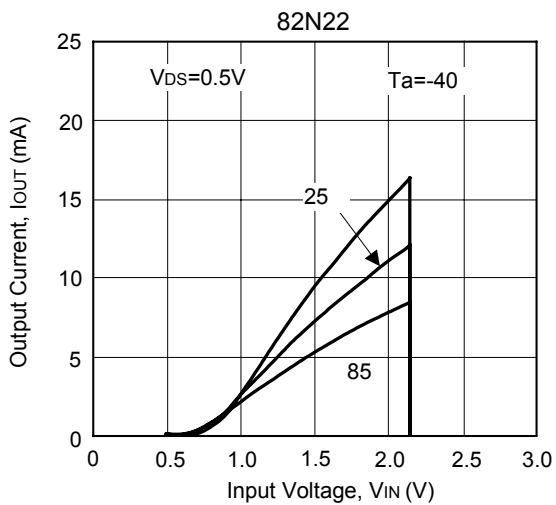
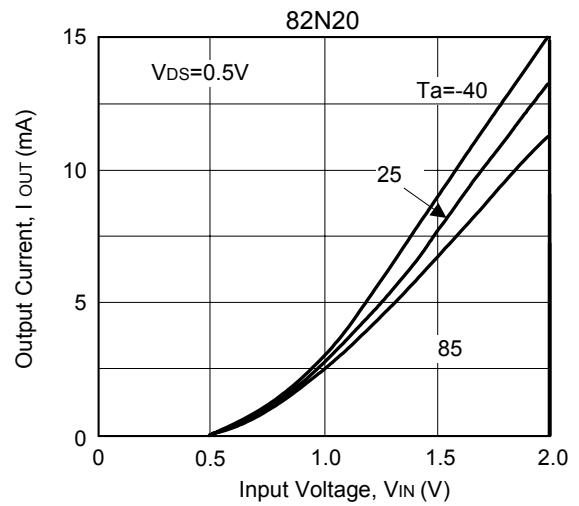
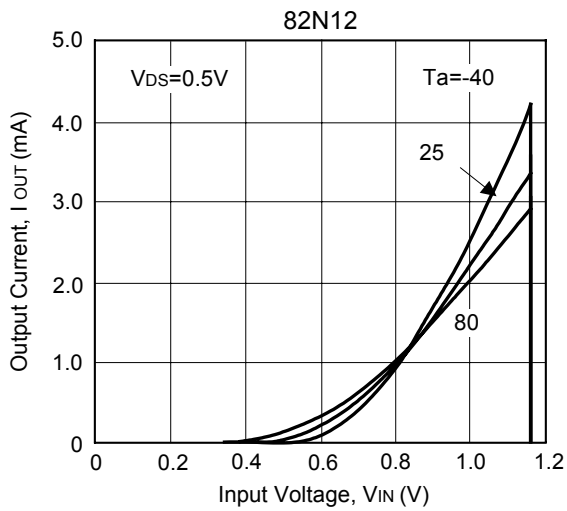
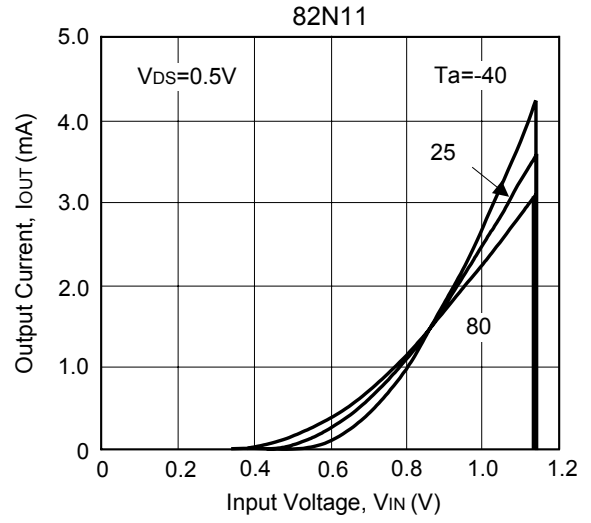
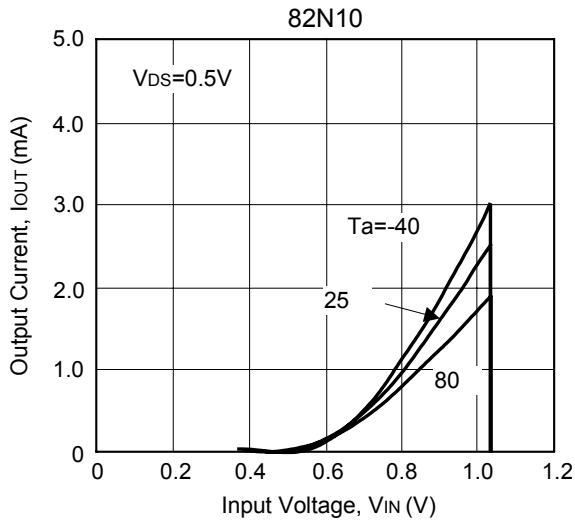

■ TYPICAL PERFORMANCE CHARACTERISTICS (Cont.)
 (3) DRIVER OUTPUT CURRENT vs. INPUT VOLTAGE(Cont.)

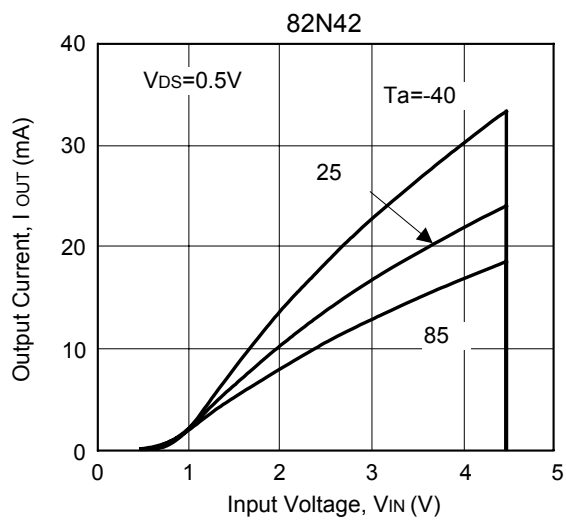
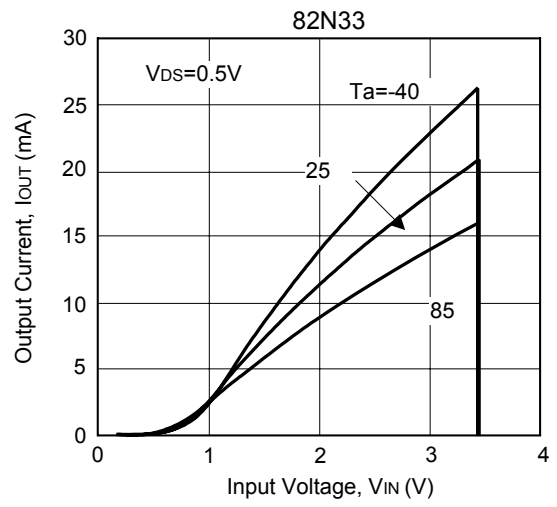
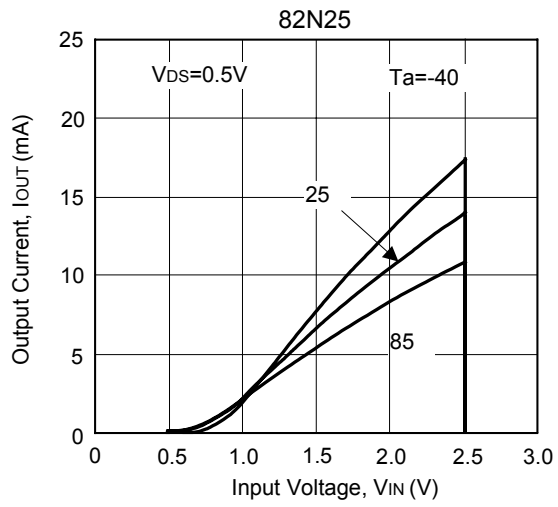

■ TYPICAL PERFORMANCE CHARACTERISTICS (Cont.)
(4) DRIVER OUTPUT CURRENT vs. V_{DS}

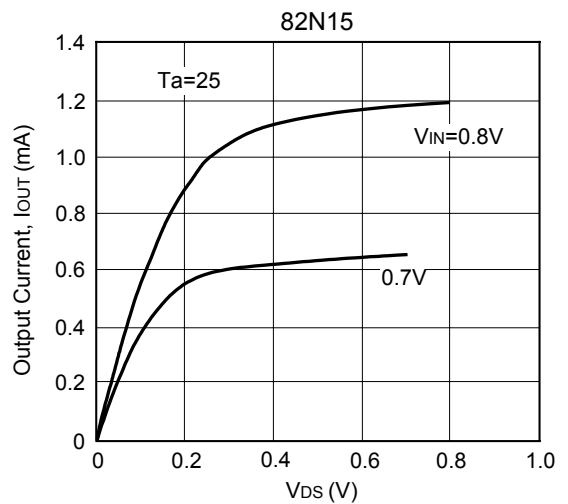
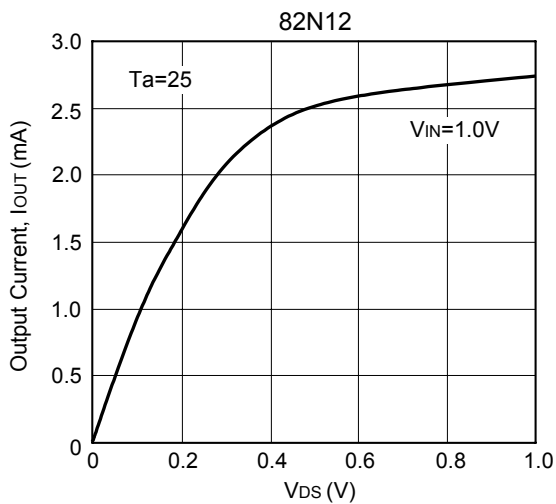
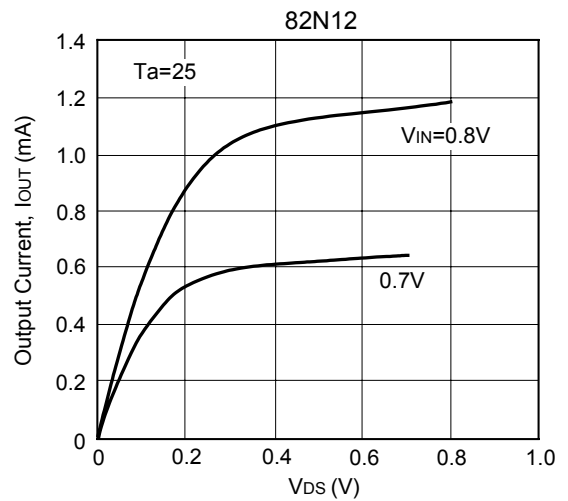
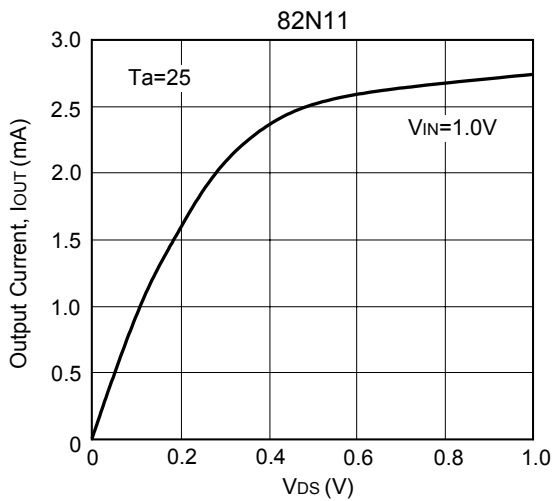
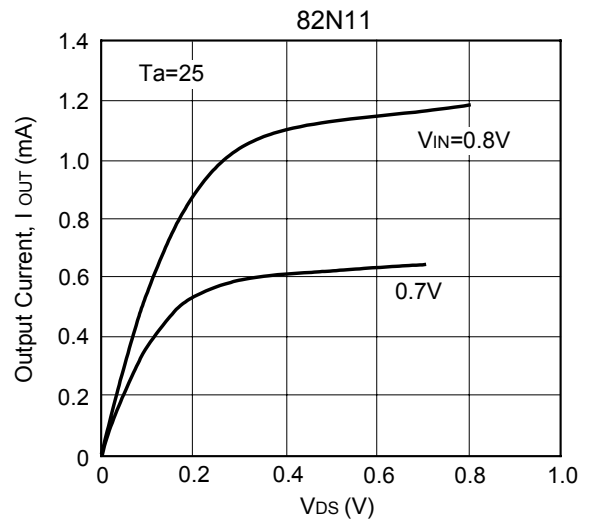
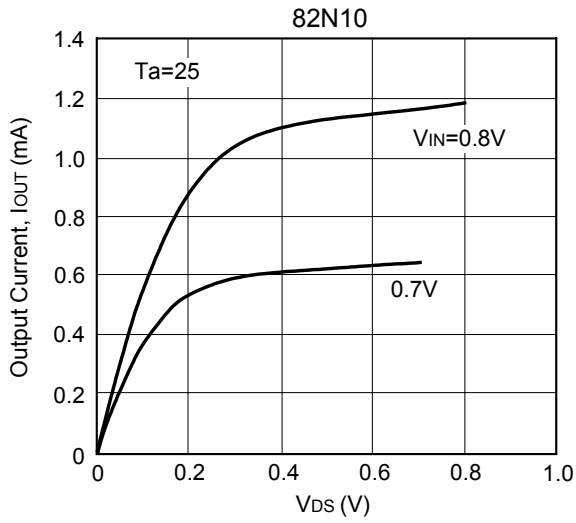

■ TYPICAL PERFORMANCE CHARACTERISTICS (Cont.)
 (3) DRIVER OUTPUT CURRENT vs. V_{DS} (Cont.)

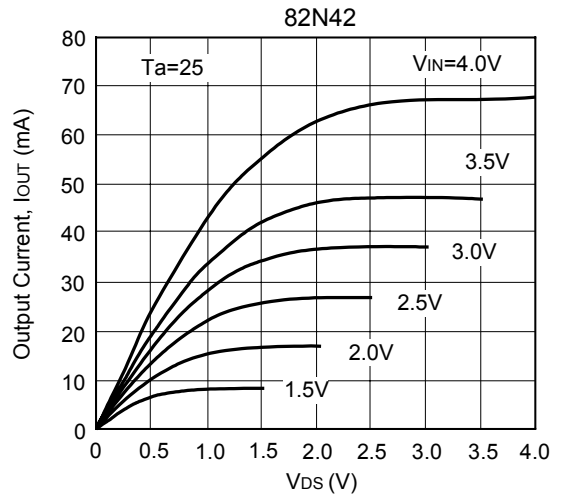
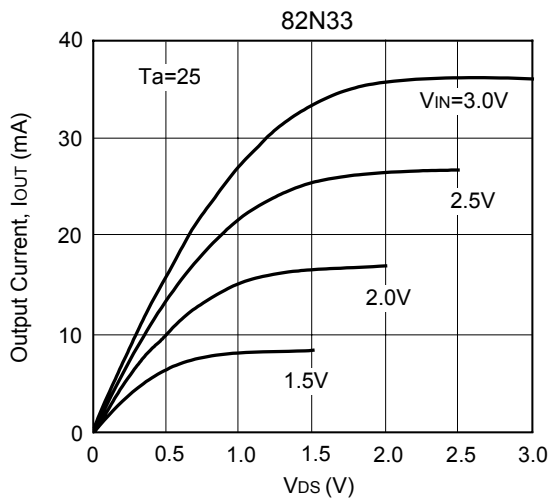
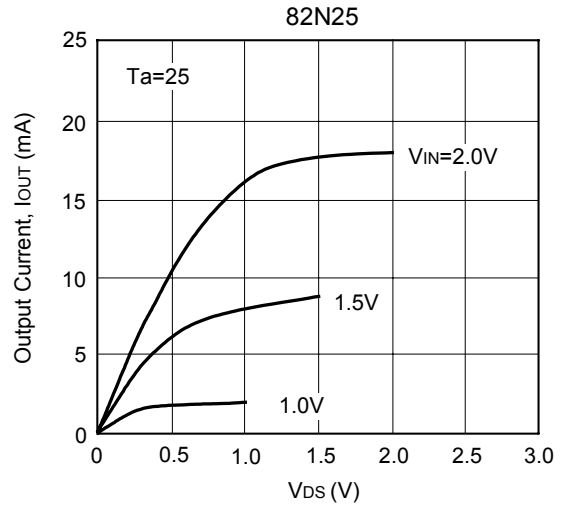
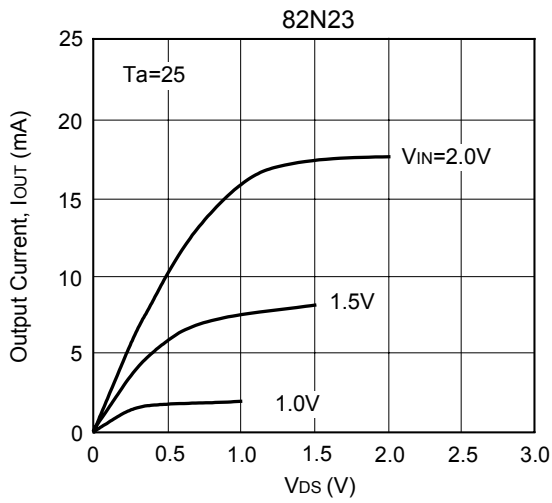
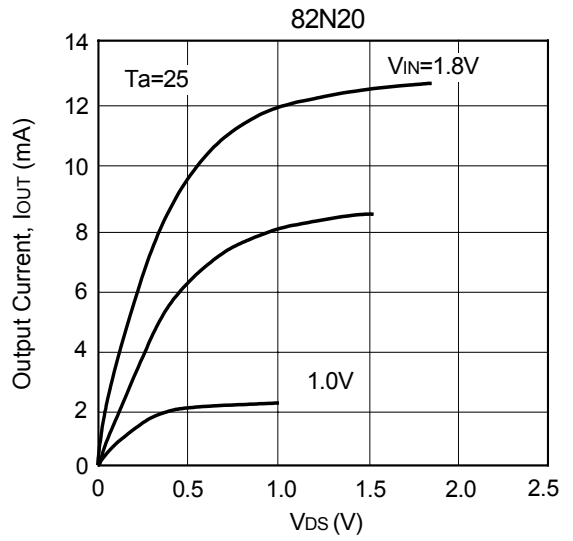
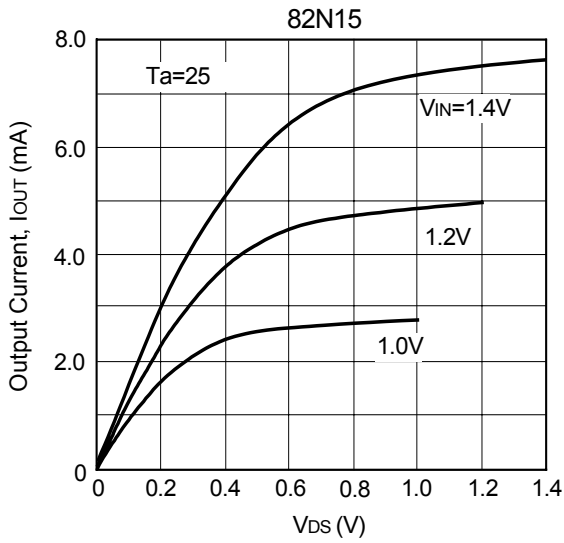

UTC assumes no responsibility for equipment failures that result from using products at values that exceed, even momentarily, rated values (such as maximum ratings, operating condition ranges, or other parameters) listed in products specifications of any and all UTC products described or contained herein. UTC products are not designed for use in life support appliances, devices or systems where malfunction of these products can be reasonably expected to result in personal injury. Reproduction in whole or in part is prohibited without the prior written consent of the copyright owner. The information presented in this document does not form part of any quotation or contract, is believed to be accurate and reliable and may be changed without notice.