



# AN-9067

## Analysis of MOSFET Failure Modes in LLC Resonant Converter

### Abstract

The trend in power converters is towards increasing power densities. To achieve this goal, it is necessary to reduce power losses, overall system size, and weight by increasing the switching frequency. High reliability is also very important for today's switched-mode power supplies (SMPS). The zero-voltage-switching (ZVS) or zero-current-switching (ZCS) topologies that allow for high-frequency switching while minimizing the switching losses are of interest. The ZVS topology operating at high frequency can improve the efficiency as well as reduce the size of the application. It also reduces the stress on power switches and therefore improves the reliability. LLC resonant half-bridge converters are becoming a popular topology because they can provide these benefits. It has become widely accepted for applications from high-end servers to flat-panel display power supplies, but the ZVS bridge topologies including LLC resonant half bridge require a MOSFET with fast reverse-recovery body diode for better reliability. This application note discusses potential failure mode and mechanism in LLC resonant converters and provides a simple and cost-effective solution to prevent failures.

### Introduction

Increasing power density and achieving higher efficiency are the most challenging issues in power conversion market, especially in the telecom/server power supply application. The most popular approach for increased power density is increasing the switching frequency, which reduces the size of passive components. The zero-voltage-switching (ZVS) topologies that enable high-frequency switching are growing popular thanks to extremely low switching losses, low devices stress, and low profile<sup>[1][2]</sup>. These resonant converters process power in a sinusoidal manner and the switching devices are softly commutated; therefore, the switching losses and noise can be dramatically reduced. Among many topologies, the phase-shifted ZVS full-bridge is widely used for medium- or high-power application since it allows all switches to operate at ZVS by effective output capacitance of power MOSFET and leakage inductance of transformer without an additional auxiliary switch. However, the ZVS range is very narrow and the freewheeling current consumes high circulating energy. Recently, power MOSFET failures have been issued in the phase-shifted ZVS full-bridge topology<sup>[3]</sup>. The primary cause of failure is slow reverse recovery of the MOSFET

body diode under low reverse voltage. Another cause of failure is due to the  $C_{dv}/dt$  shoot-through at no- or light-load conditions<sup>[4]</sup>. In LLC resonant converters, a potential failure mode can be associated with shoot-through current due to poor reverse recovery characteristics of the body diode<sup>[5][6]</sup>. Even though voltage and current of power MOSFETs are within safe operating area, some unexpected failures associated with shoot-through current, reverse recovery  $dv/dt$ , and breakdown  $dv/dt$  occur in conditions such as startup, overload, and output short circuit.

### LLC Resonant Half-Bridge Converter

An LLC resonant converter has many advantages over conventional resonant converters, as shown below.<sup>[7]</sup>

- Wide output regulation range with a narrow switching frequency range
- Guaranteed ZVS, even at no load
- Utilization of all essential parasitic elements to achieve ZVS.

An LLC resonant converter can overcome the limitations of conventional resonant converters. For these reasons, LLC resonant converters are widely used in the power supply market. LLC resonant half-bridge converter topology is shown in Figure 1 with its typical waveforms shown in Figure 2. In Figure 1, the resonant tank consists of a capacitor,  $C_r$ , in series with two inductors  $L_r$  and  $L_m$ . One of these inductors,  $L_m$ , represents the magnetizing inductor of the transformer and creates one resonating point, together with resonant inductor,  $L_r$  and resonant capacitor,  $C_r$ .  $L_m$  is fully shorted by a reflected load,  $R_{LOAD}$  at heavy load or will remain in a series with the resonant inductor  $L_r$  at light load. As a result, the operation frequency depends on the loading conditions.  $L_r$  and  $C_r$  determine the resonant frequency,  $f_{r1}$ , and  $C_r$  and two inductors,  $L_r$  and  $L_m$ , determine the second resonant frequency,  $f_{r2}$ . It shifts to higher frequency as load gets heavier. The resonant frequency moves between a minimum and a maximum by the transformer and the resonant capacitance  $C_r$ , as shown by Equations 1 and 2.

$$f_{r1} = \frac{1}{2\pi\sqrt{L_r \cdot C_r}} \quad (1)$$

$$f_{r2} = \frac{1}{2\pi\sqrt{(L_r + L_m) \cdot C_r}} \quad (2)$$

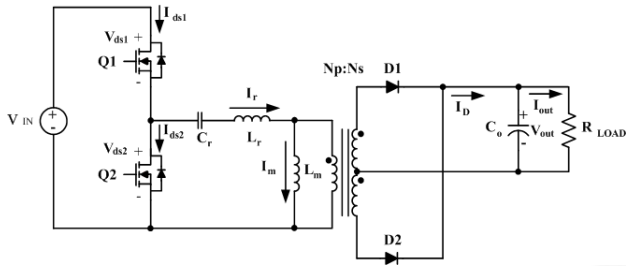


Figure 1. LLC Resonant Converter

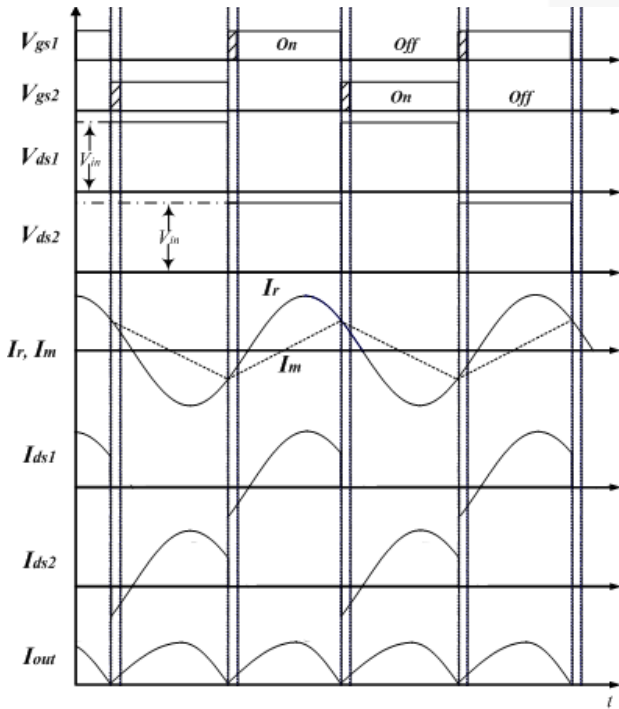


Figure 2. Typical Waveforms of LLC Resonant Converter

## Failure Modes in LLC Resonant Converter

### Startup Failure Mode

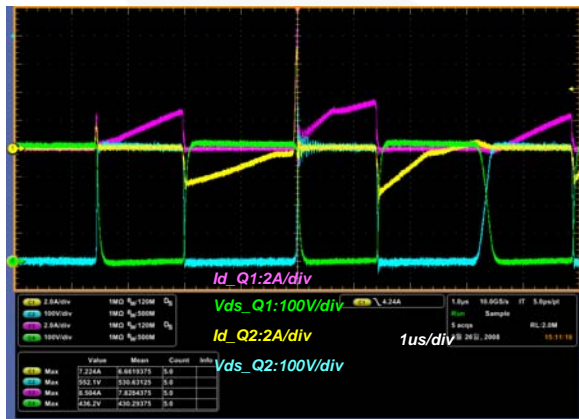


Figure 3. Measured Waveforms of Power MOSFETs at Startup

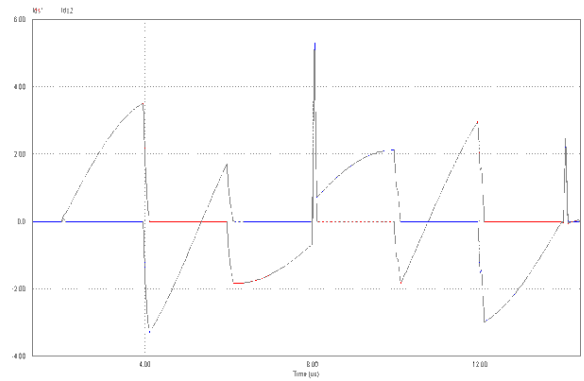


Figure 4. Simulated Waveforms of Power MOSFETs at Startup

Figure 3 and Figure 4 show the first five switching waveforms of the power MOSFET at startup. Just before startup of the converter, resonant capacitance and output capacitance are completely discharged. These empty capacitances cause further conduction of the body diode of low-side switch, Q2, during startup compared to normal operation conditions. As a result, reverse recovery current, which flows through body diode of switch Q2, is much higher, and is enough to make shoot-through problems when the high-side switch Q1 is turned on. The potential failure of the power MOSFET may occur during body diode reverse recovery at startup state. Figure 5 shows simplified waveforms of a LLC resonant half-bridge converter during startup.

Figure 6 shows operation modes that may cause potential device failure. During  $t_0 \sim t_1$ , resonant inductor current,  $I_r$ , becomes positive. Since MOSFET Q1 is on state, resonant inductor current flows through the channel of MOSFET Q1. As  $I_r$  begins to rise, the secondary diode, D1, conducts. Therefore, the rising slope of resonant inductor current  $I_r$  can be represented by Equation 3. Since the  $v_c(t)$  and  $v_o(t)$  is zero at startup, all the input voltage is applied to resonant inductor  $L_r$ . This causes sharp increase of resonant current.

$$di_r = \frac{V_{in} - v_L(t) - v_o(t) \cdot \frac{N_p}{N_s}}{L_r} dt \quad (3)$$

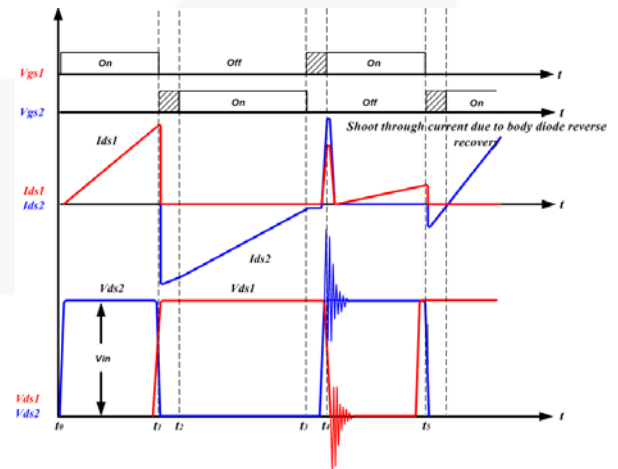


Figure 5. Simplified Waveforms for Potential Failure Mode at Startup State

During  $t_1 \sim t_2$ , gate drive signal of MOSFET Q1 is turned off and resonant inductor current starts flowing through body diode of MOSFET Q2, which creates a ZVS condition for MOSFET Q2. Gate signal of MOSFET Q2 should be applied during this mode. Due to sharply increased resonant current, body diode of MOSFET Q2 sees larger current than normal operation. This results in more stored charges in P-N junction of MOSFET Q2.

During  $t_2 \sim t_3$ , MOSFET Q2 gate signal is applied and the highly increased resonant current during  $t_0 \sim t_1$  flows through channel of MOSFET Q2. Since output diode D1 is still conducting, the voltage  $v_L(t) + v_o(t) \cdot \frac{N_p}{N_s}$  is applied to resonant inductor during this period. This voltage decreases the resonant current  $i_r(t)$ . However, since the voltage  $v_L(t) + v_o(t) \cdot \frac{N_p}{N_s}$  is small and not enough to reverse the current direction during this period, MOSFET Q2 current still flows from source to drain at  $t_3$ . In addition, body diode of MOSFET Q2 cannot recover because there is no reverse voltage between drain and source. Rising slope of resonant inductor current  $I_r$  can be represented by:

$$di_r = \frac{v_L(t) + v_o(t) \cdot \frac{N_p}{N_s}}{L_r} dt \tag{4}$$

During  $t_3 \sim t_4$ , resonant inductor current continuously flows through the body diode of MOSFET Q2 only. This current adds more stored charge in the junction of MOSFET Q2 although current level is not high.

During  $t_4 \sim t_5$ , the MOSFET Q1 channel turns on and a large shoot-through current flows due to reverse-recovery current of the body diode of MOSFET Q2. This is not accidental shoot-through because gate signals for high-side and low-side MOSFETs are normally applied; but it affects the switching power supply just like shoot-through current. It makes a high reverse recovery  $dv/dt$  and sometimes breaks down the MOSFET Q2. This can cause the failure of MOSFET and the failure mechanism can be more severe when using a MOSFET with poor reverse-recovery characteristic of body diode.

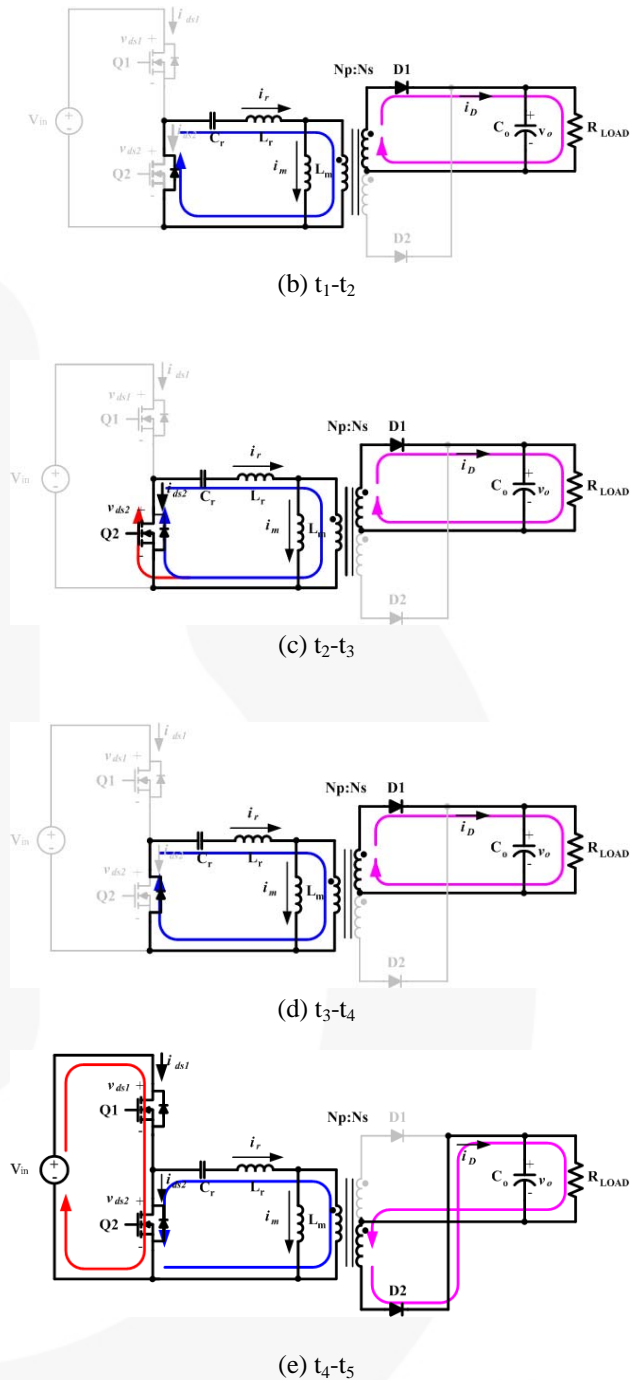
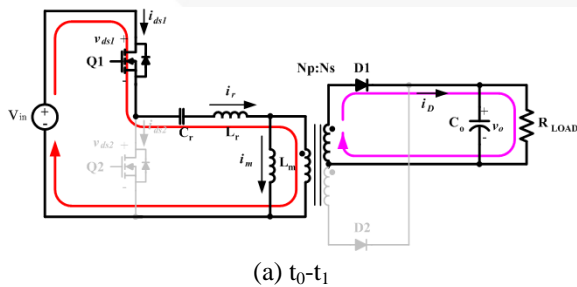


Figure 6. Potential Failure Operation Mode of LLC Resonant Half-Bridge Converter



### Overload Failure Mode

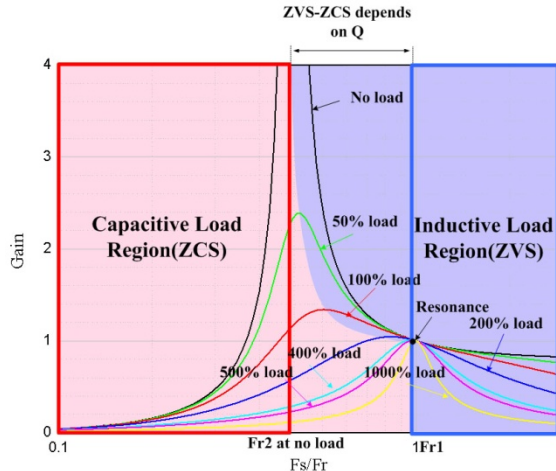
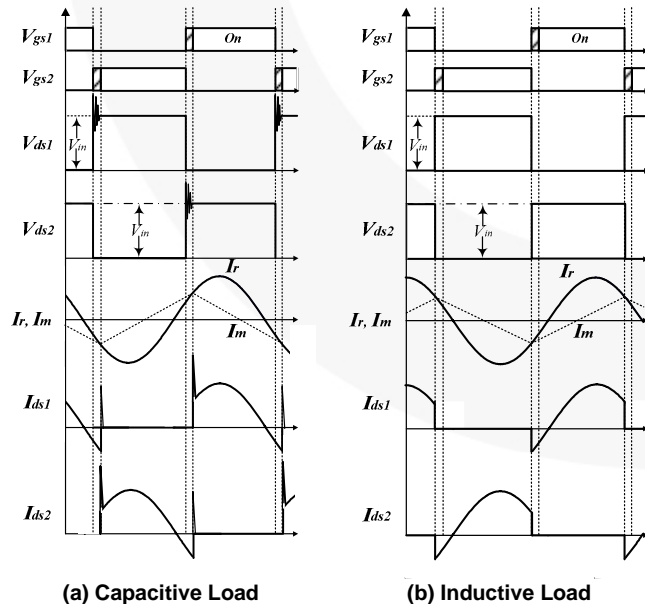


Figure 7. DC Gain of LLC Resonant Converter

The DC gain characteristics of an LLC resonant converter at different loads are shown in Figure 7. They are classified into three regions according to different operating frequency and load condition. The right side (blue box) of resonant frequency,  $f_{r1}$ , is the ZVS region and the left side (red box) of minimum second resonant frequency,  $f_{r2}$  at no load, is the ZCS region. The region between  $f_{r1}$  and  $f_{r2}$  can be either ZVS or ZCS region, according to load condition. Therefore, the purple region represents inductive load region and the pink region represents capacitive load region. Simplified waveforms at inductive load and capacitive load are shown in Figure 8. For switching frequency,  $f_s < f_{r2}$ , the input impedance of the resonant tank represents a capacitive load. Therefore, the current through the resonant circuit leads the fundamental component of the voltage applied to the MOSFET; therefore, the MOSFET current is positive after MOSFET turn-on and is negative before turn-off.



(a) Capacitive Load (b) Inductive Load

Figure 8. Simplified Waveforms at Capacitive Load (a) and Inductive Load (b)

The MOSFET switches are turned off at zero current. Prior to the MOSFET turn-on, the current flows through the body diode of the other MOSFET. When the MOSFET switch turns on, reverse-recovery stress of the other MOSFET's body diode is very severe. This high reverse-recovery current spike flows through the other MOSFET switch because it cannot flow through resonant circuit. It creates large switching losses and its current and voltage spike can cause device failure. Therefore, the converter should avoid operating in this region.

For  $f_s > f_{r1}$ , input impedance of the resonant tank is an inductive load. The MOSFET current is negative after turn-on and positive before turn-off. The MOSFET switches are turn on at zero voltage (ZVS). Therefore, the turn-on switching loss is minimized because Miller's effect is absent; MOSFET input capacitance is not increased by Miller's effect. Also, the body diode reverse-recovery current is a fraction of a sine wave and becomes a part of the switch current when switch current is positive. Therefore, ZVS is usually preferred to ZCS because it can eliminate the major switching losses and stress due to reverse-recovery current and the discharging of its junction capacitance.

Figure 9 shows how an operating point moves during overload condition. The converter operates with ZVS in normal operation, but the operating point moves to the ZCS region under overload condition and the characteristics of series resonant converter become dominant. During overload condition, the switch current is increased and ZVS is lost.  $L_m$  is fully shorted by a reflected load,  $R_{LOAD}$ , at overload condition. This condition usually results in ZCS operation. The most severe drawback of ZCS operation (below resonance) is hard switching at turn-on lead to the diode reverse-recovery stress. Furthermore, switching loss increases at turn on and noise or EMI is generated.

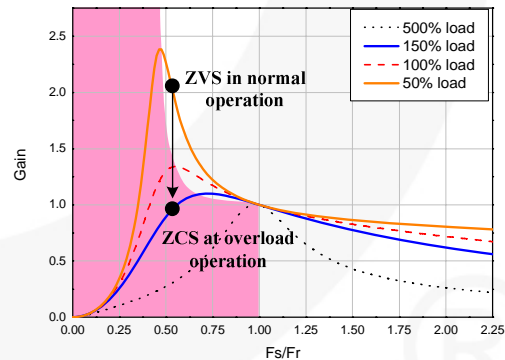


Figure 9. Operating Points of LLC Resonant Converter According to Load Condition

The diode turns off at a very large  $dv/dt$  and, therefore, at a very large  $di/dt$ , generates a high reverse-recovery current spike. These spikes can be over ten times higher than the magnitude of the steady-state switch current. This high current causes considerable increase in losses and heats up the MOSFET. Then, an increase in junction temperature degrades  $dv/dt$  capability of MOSFET. In extreme cases, it may destroy the MOSFET and cause system failure. In

specific applications, load conditions are suddenly changed from no load to overload, and more rugged operating is required for system reliability.

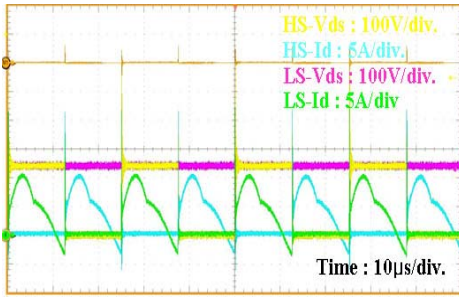


Figure 10. Measured Waveforms of Power MOSFETs at Overload Condition

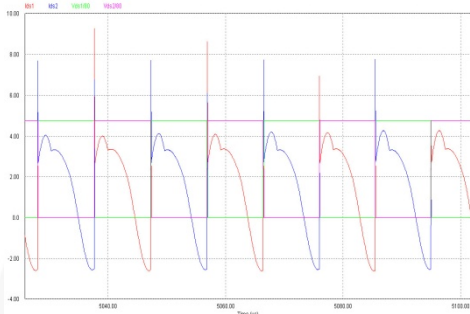


Figure 11. Simulated Waveforms of Power MOSFETs at Overload Condition

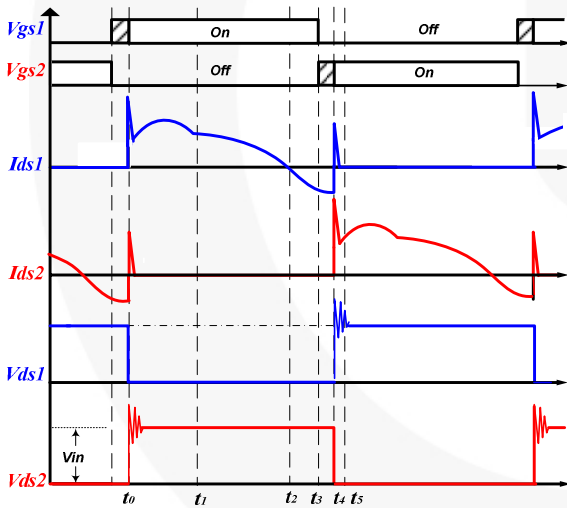


Figure 12. Simplified Waveforms for Potential Failure Mode at Overload Condition

Figure 10 and Figure 11 show the switching waveforms of the power MOSFETs at overload condition. The current spike occurs in both turn-on and turn-off transitions. It can be regarded as a “temporary shoot-through.” Figure 12 shows simplified waveforms of LLC resonant converter during overload condition and Figure 13 shows operation modes that may cause potential device failure.

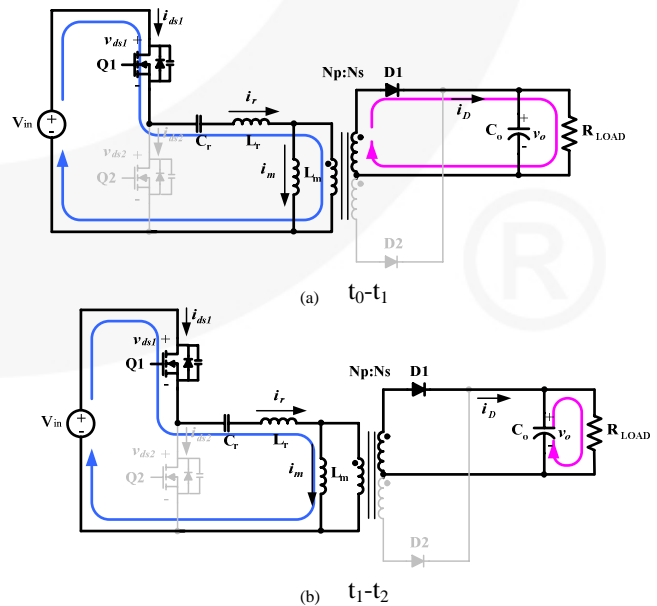
During  $t_0 \sim t_1$ , resonant inductor current  $I_r$  is already positive as Q1 is switched on. Since MOSFET Q1 is ON state, resonant current flows through the channel of MOSFET Q1 and secondary diode D1 conducts.  $L_m$  is not participating in resonance and  $C_r$  resonates with  $L_r$ . Energy is transferred from input to output.

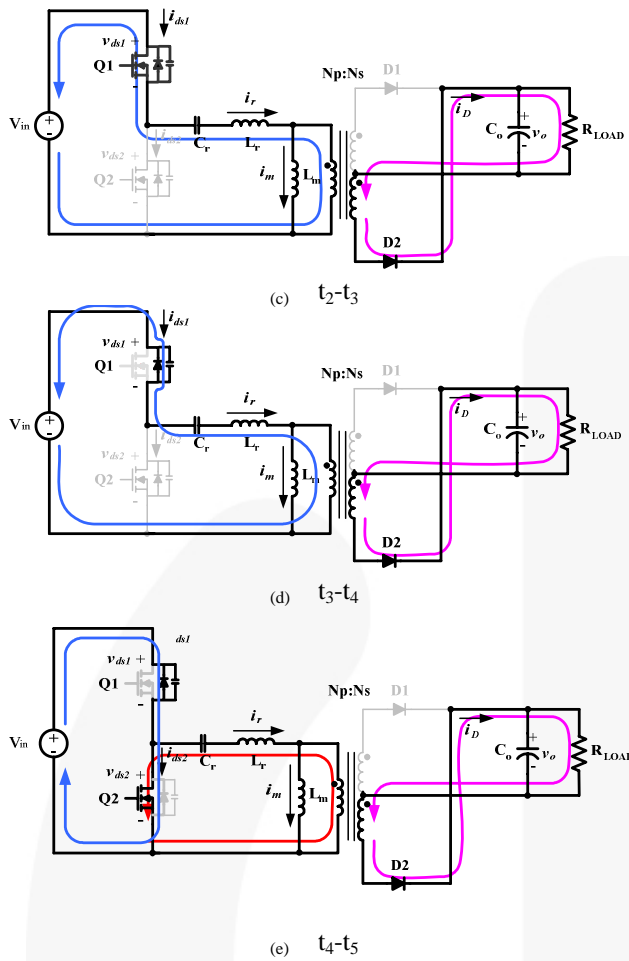
During  $t_1 \sim t_2$ , the gate drive signal of Q1 is turned on and Q2 is turned off, output current reaches zero at  $t_1$ , and the two inductors' current,  $I_r$  and  $I_m$ , is equal. Secondary diodes are not conducting and both output diodes are reverse biased. Energy is no longer transferred from input, but it comes from the output capacitor. Since output is separated from the transformer,  $L_m$  participates to resonance as in series to  $L_r$ .

During  $t_2 \sim t_3$ , the MOSFET Q1 gate signal is still applied, Q2 is turned off, and resonant inductor current direction is changed during this period. The current flows from source to drain of MOSFET Q2. D2 starts conducting while D1 is reverse biased and output current begin to increase. Energy is re-circulating into input.

During  $t_3 \sim t_4$ , gate signals for MOSFETs Q1 and Q2 are turned off and resonant inductor current starts flowing through the body diode of MOSFET Q2, which creates a ZCS condition for MOSFET Q1.

During  $t_4 \sim t_5$ , MOSFET Q2 channel turns on and a large shoot-through current flows due to reverse-recovery current of the body diode of MOSFET Q1. This is not accidental shoot-through because gate signals for high-side and low-side MOSFETs are normally applied, but it affects the switching power supply just like shoot-through current. It makes a high reverse recovery current and sometimes breaks down the MOSFET Q1. This can cause the failure of MOSFET and the failure mechanism can be more severe when using a MOSFET with poor reverse-recovery characteristics of the body diode.

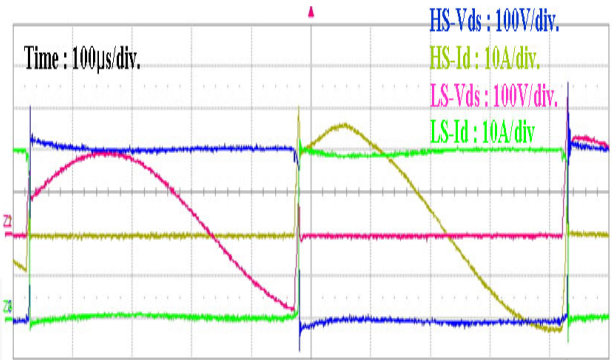




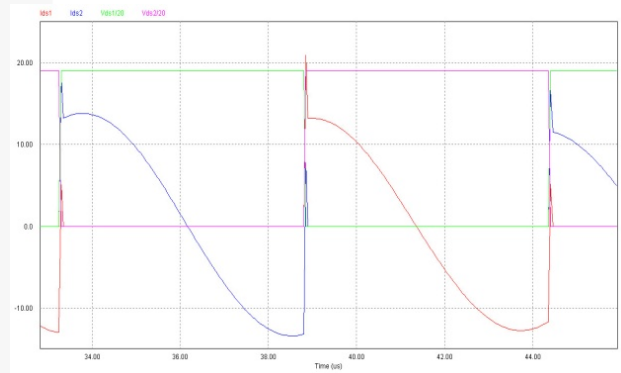
**Figure 13. Potential Failure Operation Mode of LLC Resonant Half-Bridge Converter at Overload Condition**

### Short-Circuit Failure Mode

The worst case is a short-circuit condition. During short circuit, the MOSFET conducts extremely high (theoretically unlimited) current and frequency is reduced. When short circuit occurs,  $L_m$  is shunted in resonance. LLC resonant converter can be simplified as a series resonant tank by  $C_r$  and  $L_r$  because  $C_r$  resonates with only  $L_r$ . Therefore, the period,  $t_1 \sim t_2$  in Figure 12 is absent and secondary diodes are continuously conducting in CCM mode at short circuit. Operation mode during short circuit is almost same as overload condition, but short-circuit condition is worse because reverse-recovery current, which flows through the body diode of the switch, is much higher.



**Figure 14. Measured Waveforms of Power MOSFETs at Short-Circuit Condition**



**Figure 15. Simulated Waveforms of Power MOSFETs at Short-Circuit Condition**

Figure 14 and Figure 15 show the switching waveforms of the power MOSFETs at short circuit condition. Waveforms during short circuit are similar with those during overload condition, but the current level during short-circuit condition is much higher and can lead to increased junction temperature of MOSFETs and make it easier to fail.

## Power MOSFET Failure Mechanisms

### Body Diode Reverse Recovery $dv/dt$

The switching process of the diode from on state to reverse blocking state is called reverse recovery. Figure 16 shows reverse recovery waveforms of MOSFET body diode. Firstly, the body diode was forward-conducted for a while. During this period, charges are stored in the P-N junction of the diode. When reverse voltage is applied across the diode, stored charge should be removed to go back to blocking state. The removal of the stored charge occurs via two phenomena: the flow of a large reverse current and recombination. A large reverse-recovery current occurs in the diode during the process. This reverse-recovery current flows through the body diode of MOSFET because the channel is already closed. Some of reverse recovery current flows right underneath N+ source.

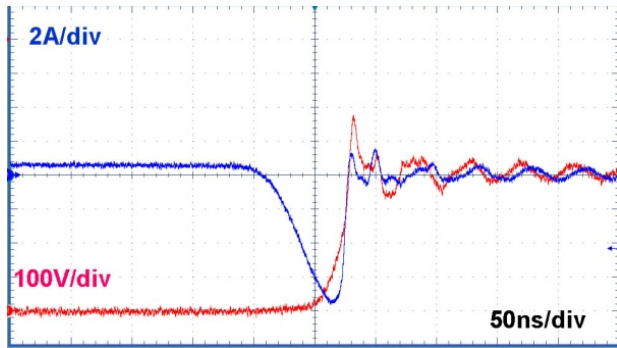


Figure 16. Voltage and Current Waveforms During Reverse Recovery of Body Diode

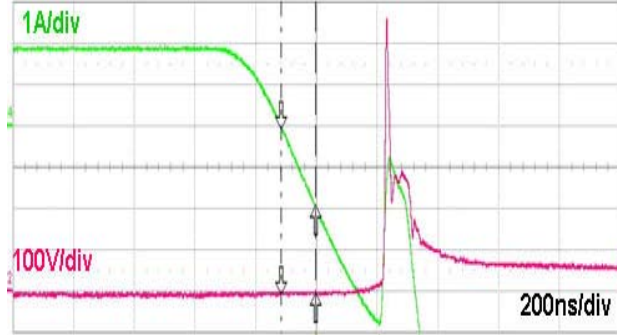


Figure 17. Voltage and Current Waveforms During Reverse Recovery of Body Diode Failing

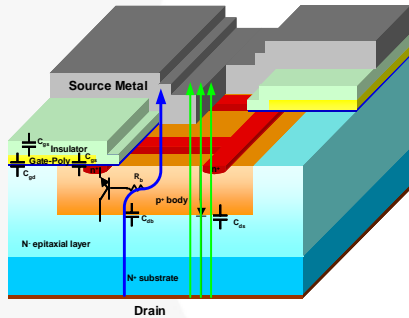


Figure 18. MOSFET Vertical Structure and Parasitic Elements

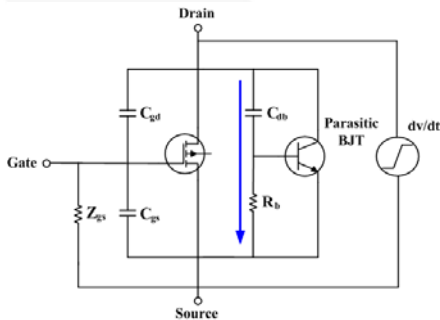


Figure 19. MOSFET Equivalent Circuit

As shown in Figure 18 and Figure 19, there is a little resistance described as  $R_b$ . Basically, base and emitter of parasitic BJT are shorted together by source metal. Therefore, the parasitic BJT should not be activated. In practice, however, the small resistance works as base resistance. When large current flows through  $R_b$ , a voltage

across  $R_b$  that acts as base-emitter forward bias becomes high enough to trigger the parasitic BJT. Once the parasitic BJT turns on, a hot spot is formed and more current crowds into it. More current flows through it due to negative temperature coefficient of the BJT. Finally, the device fails. Figure 17 shows MOSFET failing waveforms during body diode reverse recovery. Failure happens right after the current level reaches  $I_{rm}$ , peak reverse-recovery current. It means the peak current triggered parasitic BJT. Figure 20 and Figure 21 show burn marks on chips failed by body diode reverse recovery. The burnt point is the weakest point in the chip; easy to form hot spot or more charges to be recovered. It depends on chip design, so varies by design technology.

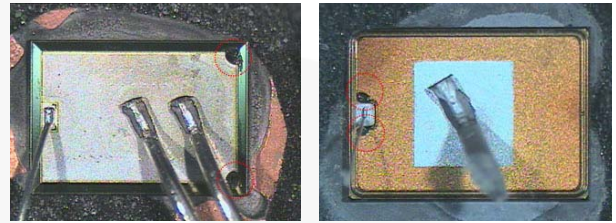


Figure 20. Different Technologies, Same  $R_{DS(ON)}$  Burn Mark on Corner (Left) and Burn Mark Near Gate Pad (Right)

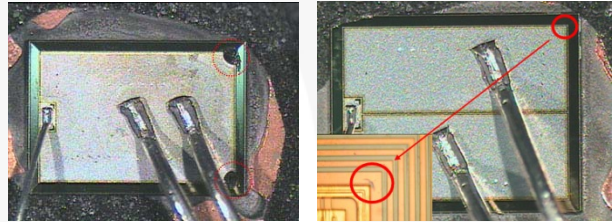


Figure 21. Same Technologies, Different  $R_{DS(ON)}$  Burn Mark on Corner in Both

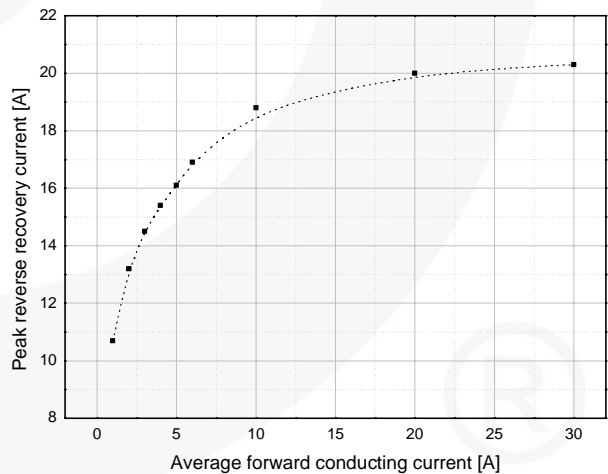


Figure 22. Peak Reverse-Recovery Current vs. Forward Current at 400A/μs

If P-N junction temperature is higher than room temperature before the process begins, it is easier to form a hot spot. So the current level and starting junction temperature are the most important factors for device failure. Major factors that affect peak reverse-recovery current are temperature, forward current, and di/dt. Figure 22 shows the increase of

peak reverse-recovery current according to the forward current level. As shown in Figure 22, body diode conduction should be minimized to lower peak reverse-recovery current. As the  $di/dt$  becomes bigger, peak reverse-recovery current goes up as well. In the LLC resonant converter, the  $di/dt$  of one power MOSFET body diode is related to turn-on speed of the other complementary power switch. So, slowing down the turn-on also lowers the  $di/dt$ .

## Breakdown $dv/dt$

Another failure mode is breakdown  $dv/dt$ . It is a combination of breakdown and static  $dv/dt$ . A device undergoes avalanche current and displacement current at same time. In the case of extremely fast transition, drain-source voltage may exceed the maximum rating of a device during body diode reverse-recovery process. For an example, maximum drain-source voltage in Figure 16 is over 570V even though the device is 500V-rated MOSFET. Because of high-voltage spike, the MOSFET enters the breakdown mode and commutating current flows through the P-N junction. It is exactly the same mechanism as avalanche breakdown. In addition to this process, high  $dv/dt$  affects the failure point of the device. More displacement current is built up with greater  $dv/dt$ . The displacement current is added to avalanche current and the device becomes more vulnerable to failure. Basically, the root cause of failure is parasitic BJT turn-on due to high current and temperature, but the primary cause is body diode reverse recovery or breakdown. In practice, these two failure modes occur randomly and sometimes combined.

## Solution

There are several methods for over-current protection during startup, overload, or short-circuit condition:<sup>[8]</sup>

- Increasing switching frequency
- Variable frequency control plus PWM control
- Using splitting cap and clamping diodes

Implementing these methods in an LLC resonant converter requires additional devices, modified control circuits, or new thermal designs that increase system cost. There could be a simpler and cost effective way. Since the body diode plays important role in LLC resonant converter and it is critical to failure mechanism, focusing on body diode characteristics at the device level is good approach to solve the problem. As more and more applications use an embedded body diode as the critical system component, many advances in body diode characteristics have been accomplished. Among them, gold or platinum diffusion and electron irradiation are known as very effective solutions. These processes control the carrier lifetime to reduce reverse-recovery charge and reverse-recovery time. As reverse-recovery charge is reduced, it results in much smaller peak reverse current and less possibility of triggering parasitic BJT. Therefore, new power MOSFETs with improved body diode can provide greater ruggedness

and better protection in over-current situations such as overload and short-circuit condition.



**Figure 23. Comparisons of Reverse Recovery Characteristics Between FRFET® and Conventional MOSFET**

Replacing a conventional power MOSFET with a FRFET® is very simple to implement and additional circuits or devices are not necessary. There are, however, drawbacks due to the processes. More lifetime control results in the further increase of MOSFET on-resistance. This adds more power losses and is critical to the overall system efficiency. Another negative effect is the increase of drain-source leakage current. To avoid these problems, finding an optimum point is very important. Figure 23 shows an improvement of reverse recovery characteristics of a FRFET® compared to a conventional MOSFET. Process parameters used for the device in Figure 23 are determined by considering both minimizing negative effects and fulfilling application requirements. This new power MOSFET with fast recovery body diode, FRFET®, fits in an LLC resonant converter perfectly. Its peak reverse recovery current has been reduced to the level that does not cause device failure, while maximum on-resistance has changed only slightly. It can withstand more than double the current stress during breakdown  $dv/dt$  mode. With all of these improved characteristics, the FRFET® provides enhanced reliability in the LLC resonant half-bridge converter.

## Experimental Results at Startup State

To verify the benefit of the FRFET® at startup state, a 240W LLC resonant half-bridge converter was designed. An input voltage is 110-220V<sub>AC</sub> and output voltage and current have set to 12V and 20A, respectively. Comparisons of critical characteristic of DUTs are listed in Table 1.

**Table 1. Comparisons of Critical Specification Comparison of DUTs**

Devices	$R_{DS(ON)}$ Max. [ $\Omega$ ]	$t_{rr}$ [ns]	$I_{rr}$ [A]	$Q_{rr}$ [ $\mu$ C]
FQPF13N50C	0.48	390.9	21.7	4.241
FQPF13N50CF	0.54	99.9	5.91	0.295

### Note:

1. Test Condition:  $V_{GS}=0V$ ,  $I_S=13A$ ,  $di/dt=100A/\mu s$ ,  $T_C=25^\circ C$ .



Table 1 shows the comparisons of  $R_{DS(on)}$ , reverse recovery time ( $t_{rr}$ ), reverse recovery current ( $I_{rr}$ ), and reverse recovery charge ( $Q_{rr}$ ). The reverse recovery charge ( $Q_{rr}$ ) of the fast-recovery body diode MOSFET, called FRFET<sup>®</sup>, is dramatically reduced almost by a factor of 14 compared to a conventional MOSFET. Waveforms of a FRFET<sup>®</sup> (FQPF13N50CF) and a conventional MOSFET (FQPF13N50C) are compared at startup state in the LLC resonant half bridge converter. Figure 20 presents key waveforms comparing reverse recovery characteristics at startup between the conventional MOSFET and the FRFET<sup>®</sup>. A peak drain-source voltage of the conventional MOSFET exceeded rated voltage (500V) and a high level of shoot-through current is induced. On the contrary, no voltage spike occurred with the FRFET<sup>®</sup>.

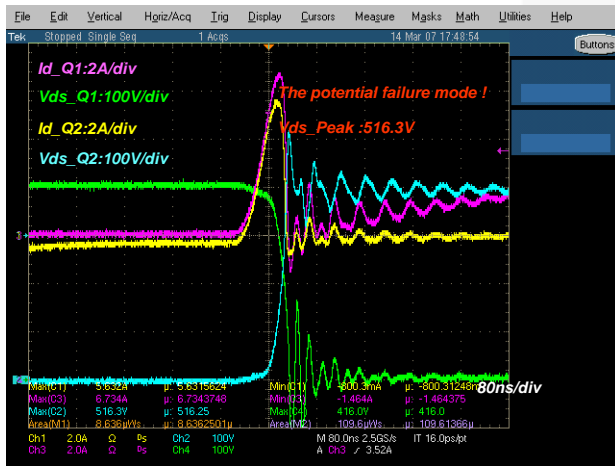


Figure 24. Shoot-Through Current with Conventional MOSFET Technology

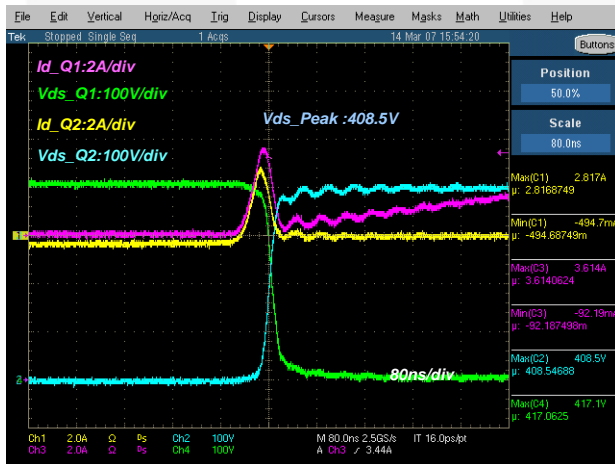


Figure 25. Shoot-Through Current Improvement with FRFET<sup>®</sup> Technology

In addition, a peak current level of the conventional MOSFET is almost double that of the FRFET<sup>®</sup>. These negative behaviors of the conventional MOSFET may result in device failure as mentioned; reverse recovery  $dv/dt$ , and breakdown  $dv/dt$ . Finally, the FRFET<sup>®</sup> can effectively minimize shoot-through current, peak drain-source voltage, and reverse recovery  $dv/dt$  - potential causes of failure in startup state.

### Experimental Results at Short Circuit

Waveforms of a fast-recovery body diode MOSFET and a conventional MOSFET are compared in the 520W LLC resonant half-bridge converter under shorted output condition.

Table 2. Comparisons of Critical Specifications Comparison of DUTs

Devices	$R_{DS(on)}$ Max. [ $\Omega$ ]	$t_{rr}$ [ns]	$I_{rr}$ [A]	$Q_{rr}$ [ $\mu$ C]
FDP20N50	0.23	507	28.40	7.2
FDP20N50F	0.26	154	6.49	0.5

**Note:**

- Test Condition:  $V_{GS}=0V$ ,  $I_S=13A$ ,  $di/dt=100A/\mu s$ ,  $T_C=25^\circ C$ .

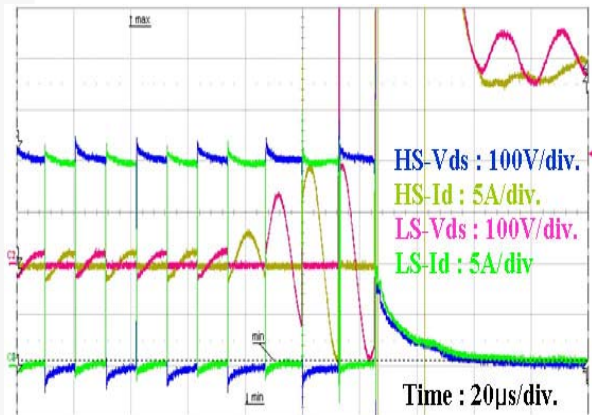


Figure 26. Waveforms of Conventional Power MOSFET at Short-Circuit Condition

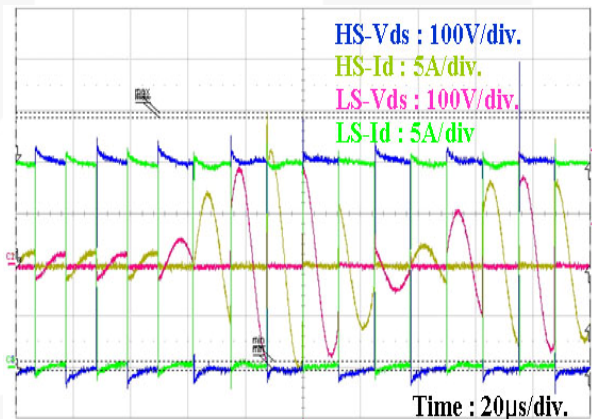


Figure 27. Waveforms of FRFET<sup>®</sup> Power MOSFETs at Short-Circuit Condition

Table 2 shows the comparisons of  $R_{DS(on)}$ , reverse recovery time ( $t_{rr}$ ), reverse recovery current ( $I_{rr}$ ), and reverse recovery charge ( $Q_{rr}$ ). The reverse-recovery charge ( $Q_{rr}$ ) of the fast-recovery type MOSFET is significantly smaller. Figure 26 and Figure 27 show the drain-source voltage and drain current waveforms of the conventional MOSFET and the FRFET<sup>®</sup> under output-short condition. Operation mode is changed from ZVS to ZCS after output short. Switching frequency is reduced and high current flows through the MOSFETs at short circuit. The current spike of a conventional MOSFET is several tens of ampere current

during short circuit. The MOSFET to be switched on carries the reverse-recovery current of the other MOSFET. Finally, the conventional MOSFET failed due to reverse-recovery  $dv/dt$  and breakdown  $dv/dt$ . The FRFET<sup>®</sup>, which has better ruggedness of reverse recovery  $dv/dt$ , survived the same condition. The  $R_{DS(ON)}$  of FRFET<sup>®</sup> is slightly higher than the conventional MOSFET, as shown in Table 2. The calculated efficiency drop due to  $R_{DS(ON)}$  gap between the normal MOSFET and the fast-recovery body diode MOSFET is just 0.024% on 520W LLC resonant converter.

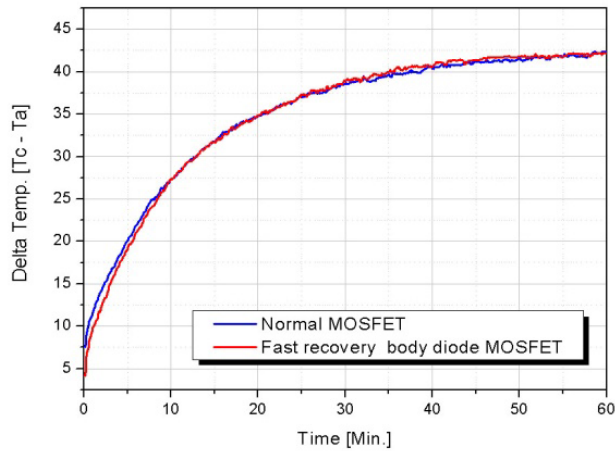


Figure 28. Temperature Comparison

The case temperatures of the two devices were almost the same, as shown in Figure 28. Finally, the FRFET<sup>®</sup> can effectively minimize shoot-through current, peak drain-source voltage, and reverse recovery  $dv/dt$ ; all of which can be potential causes of failure at overload or output short condition, without losing system efficiency.

## Conclusion

In this application note, failure modes and mechanisms are analyzed in LLC resonant converter. A new MOSFET with improved recovery body diode and better ruggedness, FRFET<sup>®</sup>, is optimized to solve the design challenges in the LLC resonant half-bridge converter. The electrical characteristics of FRFET<sup>®</sup> have been analyzed in the target application. Experimental results show that it is very effective to resolve the potential reliability problems in the system, while not affecting the total efficiency and the other system operations. The FRFET<sup>®</sup> provides enhanced system reliability in the LLC resonant half-bridge converter.

**Table 3. 500V, 600V FRFET® Line-up**

Part Number	$BV_{DSS}$	$R_{DS(ON).max} [\Omega]$ @ $V_{GS} = 10V$	$Q_{g.typ} [nC]$ @ $V_{GS} = 10V$	$I_D [A]$	$Q_{RR.typ} [nC]$ @ $di_F/dt=100A/\mu s$	Package
FQPF5N50CF	500	1.550	18	5.00	110	TO-220F
FQPF9N50CF	500	0.850	28	9.00	300	TO-220F
FQPF10N50CF	500	0.610	43	10.00	100	TO-220F
FQPF11N50CF	500	0.550	43	11.00	150	TO-220F
FQPF13N50CF	500	0.540	43	13.00	350	TO-220F
FQA13N50CF	500	0.480	43	15.00	400	TO-3PN
FQA24N50F	500	0.200	90	24.00	1100	TO-3PN
FQA28N50F	500	0.160	110	28.40	1200	TO-3PN
FQL40N50F	500	0.110	155	40.00	1300	TO-264
FDD5N50F	500	1.550	11	3.50	120	TO-252(DPAK)
FDPF5N50FT	500	1.550	8	4.50	120	TO-220F
FDD6N50F	500	1.150	15	5.50	150	TO-252(DPAK)
FDPF7N50FT	500	1.150	15	6.00	150	TO-220F
FDPF10N50FT	500	0.850	18	9.00	200	TO-220F
FDPF12N50FT	500	0.700	21	11.50	370	TO-220F
FDB12N50F	500	0.700	21	11.50	370	TO-263(D2PAK)
FDPF13N50FT	500	0.540	30	12.00	450	TO-220F
FDP20N50F	500	0.260	50	20.00	500	TO-220
FDPF20N50FT	500	0.260	50	20.00	500	TO-220F
FDA20N50F	500	0.260	50	22.00	500	TO-3PN
FDH45N50F	500	0.120	105	45.00	640	TO-247
FQPF8N60CF	600	1.500	28	6.26	242	TO-220F
FQP10N60CF	600	0.800	44	9.00	300	TO-220
FQPF10N60CF	600	0.800	44	9.00	300	TO-220F
FCP11N60F	600	0.380	40	11.00	800	TO-220
FCA20N60F	600	0.190	75	20.00	1100	TO-3PN
FCB20N60F	600	0.190	75	20.00	1100	TO-263(D2PAK)
FCA47N60F	600	0.073	210	47.00	2040	TO-3PN
FCH47N60F	600	0.073	210	47.00	2040	TO-247

## References

- [1] *N. Mohan, T. M. Undeland and W. P. Robbins, "Power Electronics, Converters, Applications, and Design," John Wiley & Son, Inc., New York 1995, 2nd Edition.*
- [2] *R. Farrington, M. M. Jovanovic, and F. C. Lee, "Analysis of Reactive Power in Resonant Converters," Proc. IEEE PESC '92, 1992.*
- [3] *Hubert Aigner. Et al., "Improving the Full-Bridge Phase-shift ZVT Converter for Failure-Free Operation Under Extream Conditions in Welding and Similar Applications," IEEE Proceedings of Industrial Application Society Annual Meeting. St. Luis, 1998.*
- [4] *Sampat Shekhawat, Mark Rinehimer, Bob Brokway, "FCS Fast Body Diode MOSFET for Phase-Shifted ZVS Full Bridge DC/DC Converter," Fairchild Application Note AN-7536.*
- [5] *Wonsuk Choi and Sungmo Young, "Improving System Reliability Using FRFET® in LLC Resonant Converters," PESC 2008, June 2008.*
- [6] *Wonsuk Choi, Sungmo Young, Dongwook Kim, "Analysis of MOSFET Failure Modes in LLC Resonant Converter," INTELEC 2009, October 2009.*
- [7] *Hangseok Choi, "Analysis and Design of LLC Resonant Converter with Integrated Transformer," APEC 2007, Feb. 2007.*
- [8] *Bo Yang, F. C. Lee, and Concannon, "Over-Current Protection Methods for LLC Resonant Converter," APEC 2003, Feb. 2003.*

## Author

**Won-suk Choi and Sungmo Young, Application Engineering**

**HV PCIA PSS Team / Fairchild Semiconductor**

**Phone +82-32-680-1839**

**Fax +82-32-680-1823**

**Email [wonsuk.choi@fairchildsemi.com](mailto:wonsuk.choi@fairchildsemi.com)**

---

### DISCLAIMER

FAIRCHILD SEMICONDUCTOR RESERVES THE RIGHT TO MAKE CHANGES WITHOUT FURTHER NOTICE TO ANY PRODUCTS HEREIN TO IMPROVE RELIABILITY, FUNCTION, OR DESIGN. FAIRCHILD DOES NOT ASSUME ANY LIABILITY ARISING OUT OF THE APPLICATION OR USE OF ANY PRODUCT OR CIRCUIT DESCRIBED HEREIN; NEITHER DOES IT CONVEY ANY LICENSE UNDER ITS PATENT RIGHTS, NOR THE RIGHTS OF OTHERS.

### LIFE SUPPORT POLICY

FAIRCHILD'S PRODUCTS ARE NOT AUTHORIZED FOR USE AS CRITICAL COMPONENTS IN LIFE SUPPORT DEVICES OR SYSTEMS WITHOUT THE EXPRESS WRITTEN APPROVAL OF THE PRESIDENT OF FAIRCHILD SEMICONDUCTOR CORPORATION.

As used herein:

1. Life support devices or systems are devices or systems which, (a) are intended for surgical implant into the body, or (b) support or sustain life, or (c) whose failure to perform when properly used in accordance with instructions for use provided in the labeling, can be reasonably expected to result in significant injury to the user.
2. A critical component is any component of a life support device or system whose failure to perform can be reasonably expected to cause the failure of the life support device or system, or to affect its safety or effectiveness.