

# Data Sheet

## PD220U06-170

Power Divider/Combiner

4-Way 0° 50Ω 1.70-2.70 GHz



### Features

- Small Size (3×3mm QFN package)
- Passive RF IC, no need external DC power supply
- No need external 100 Ω resistor
- Very Low Loss
- Tight Amplitude Balance
- High Isolation
- Low VSWR
- Good Repeatability
- Tape & Reel
- Operating Temperature -40°C~85°C
- Power handling
  - 2 Watts as a divider
  - 0.5 Watts as a combiner

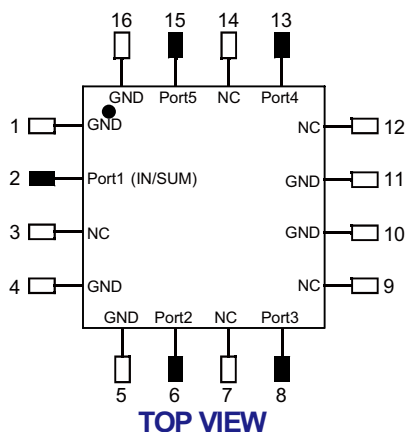
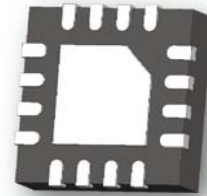

### Applications

- Wireless communications
- WLAN / WiMax
- SAT Radio
- ISM band instrument
- Information System for Automotive Safety

#### Notes:

1. Require to add Capacitors of DC Blocker between Pins(with black color) and external circuit to prevent DC signal entry to guranteeparts normal work.
2. This part has passed through 100% RF test.

### Electrical Specifications at 25° C

Parameter	Symbol	Min	Typ	Max	Unit
Frequency Range	F	1700		2700	MHz
Insertion Loss (Above 6dB)	$I_L$	0.35	0.55	0.75	dB
Isolation	$I_{sol}$	11		48	dB
Phase balance	$\varnothing_{bal}$		3		deg
Amplitude balance	$A_{bal}$		0.4~0.9		dB
Input VSWR			1.15~1.8		:1
Output VSWR			1.15~1.7		:1

### Yantel Corporation

A3.0

Add: 3F, Building 3, Southern District 2 of Zhongguan Honghualing Industrial Park, Xili, Nanshan, Shenzhen, China  
Tel: 86-755-8355-1886 Fax: 86-755-8355-2533

For detailed performance specs & shopping online see Yantel web site : [www.yantel-corp.com](http://www.yantel-corp.com)

# Data Sheet

## PD2200U06-170

Power Divider/Combiner  
4-Way 0° 50Ω 1.70-2.70 GHz

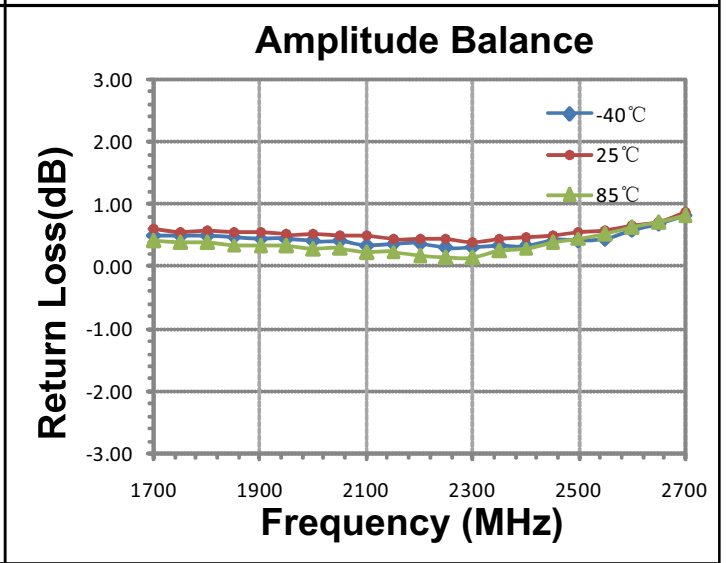
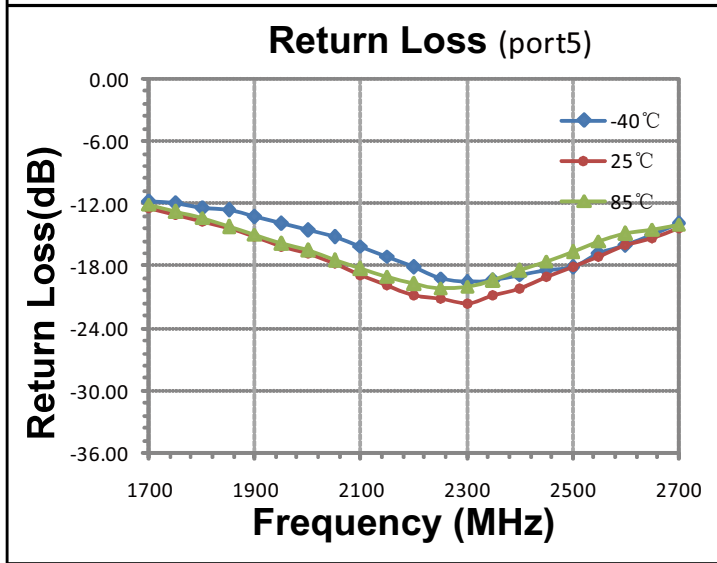
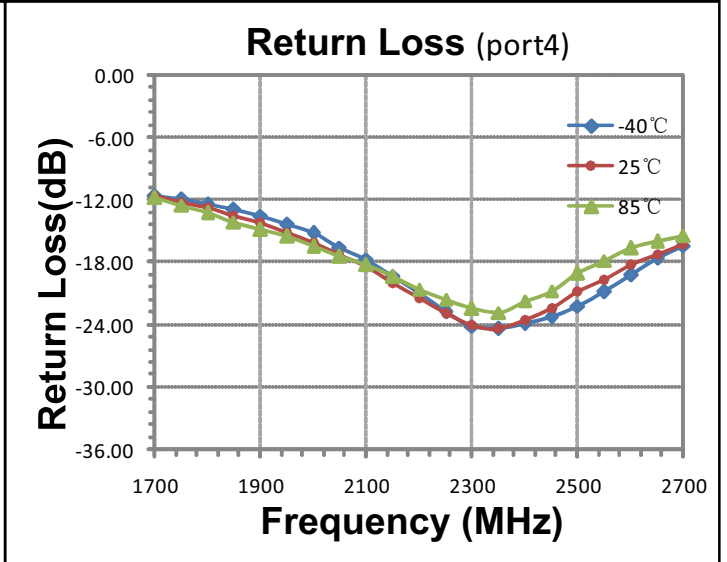
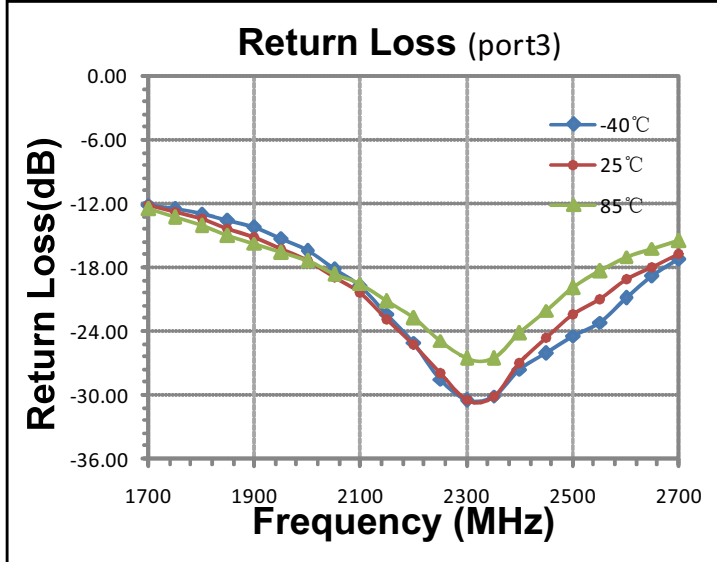
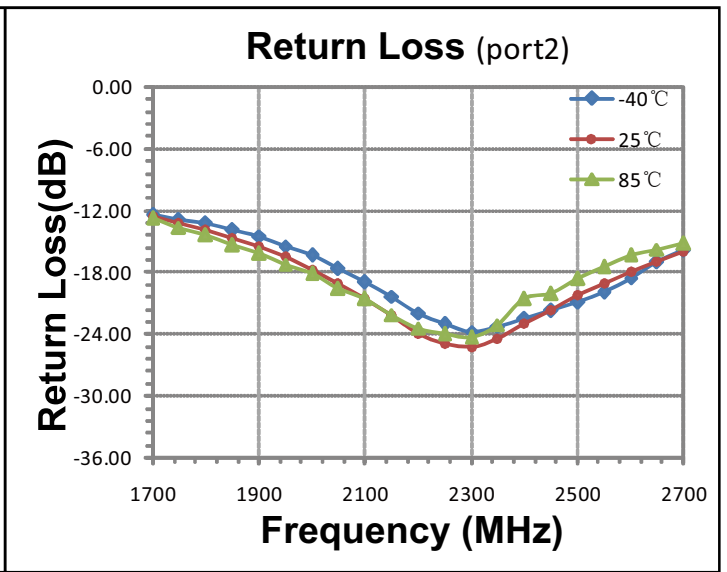
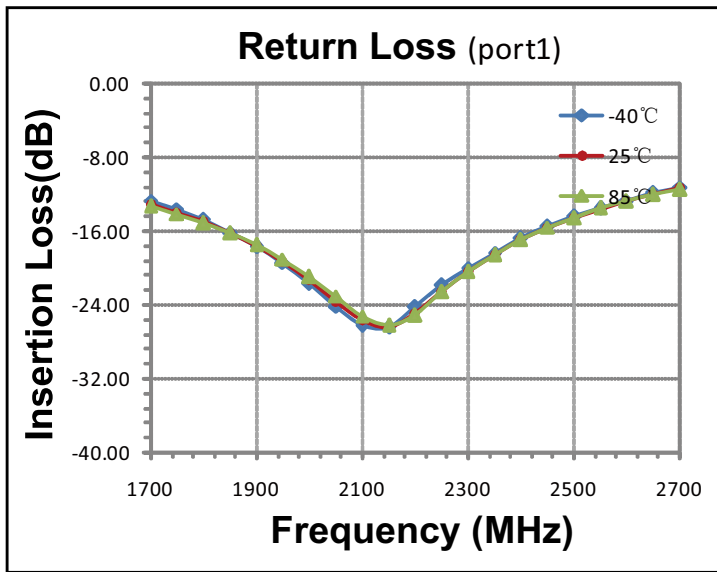

### Yantel Corporation

A3.0

Add: 3F, Building 3, Southern District 2 of Zhongguan Honghualing Industrial Park, Xili, Nanshan, Shenzhen, China

Tel: 86-755-8355-1886 Fax: 86-755-8355-2533

For detailed performance specs & shopping online see Yantel web site : [www.yantel-corp.com](http://www.yantel-corp.com)

# Data Sheet

## PD2200U06-170

Power Divider/Combiner  
4-Way 0° 50Ω 1.70-2.70 GHz

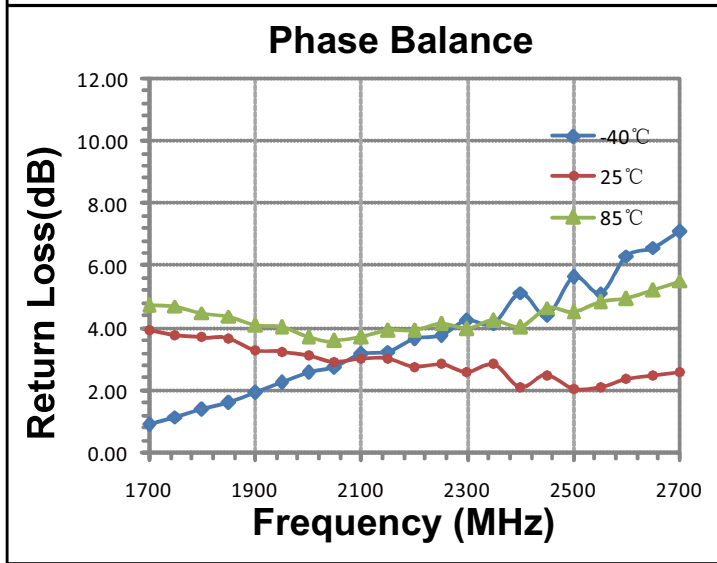
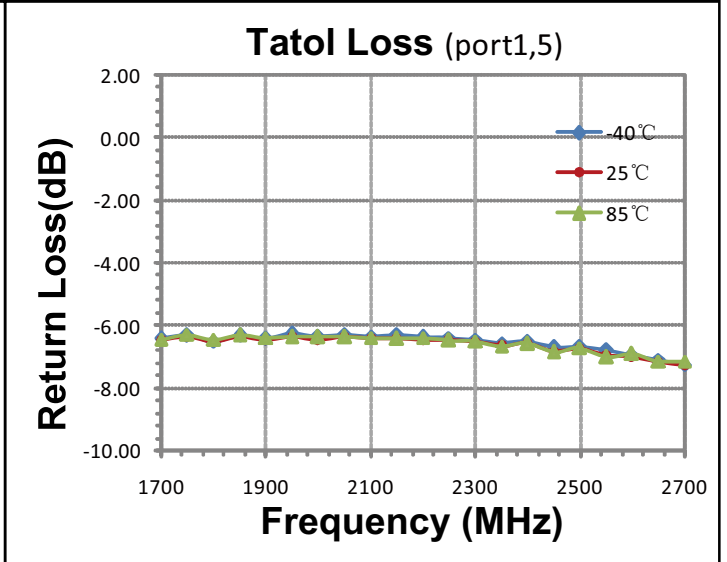
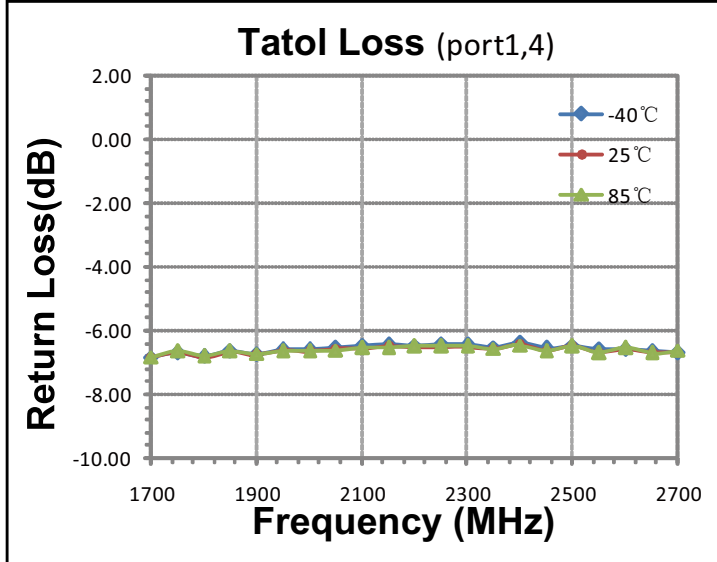
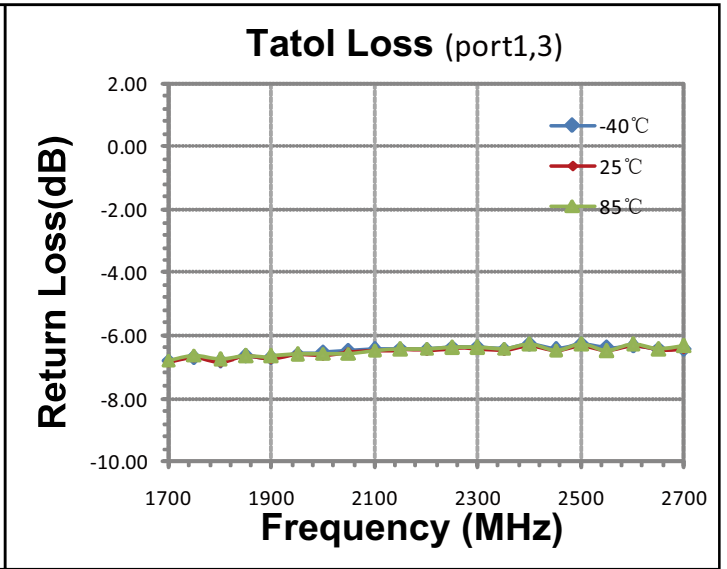
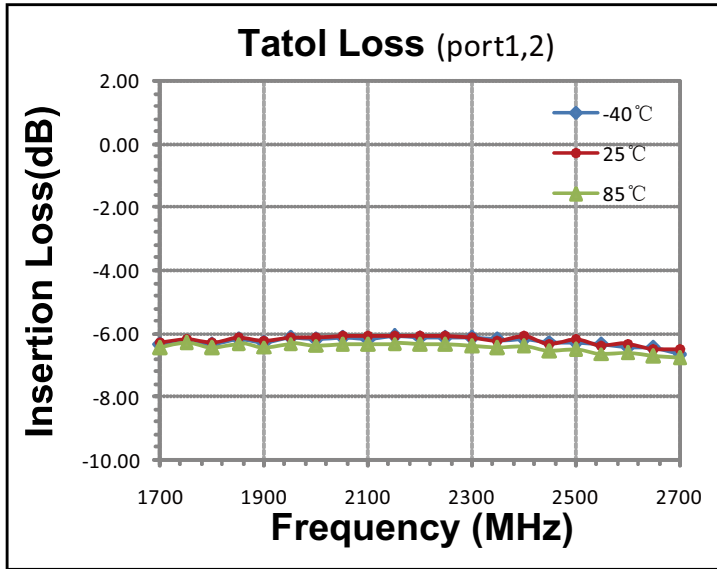

### Yantel Corporation

# Data Sheet

## PD2200U06-170

Power Divider/Combiner  
4-Way 0° 50Ω 1.70-2.70 GHz

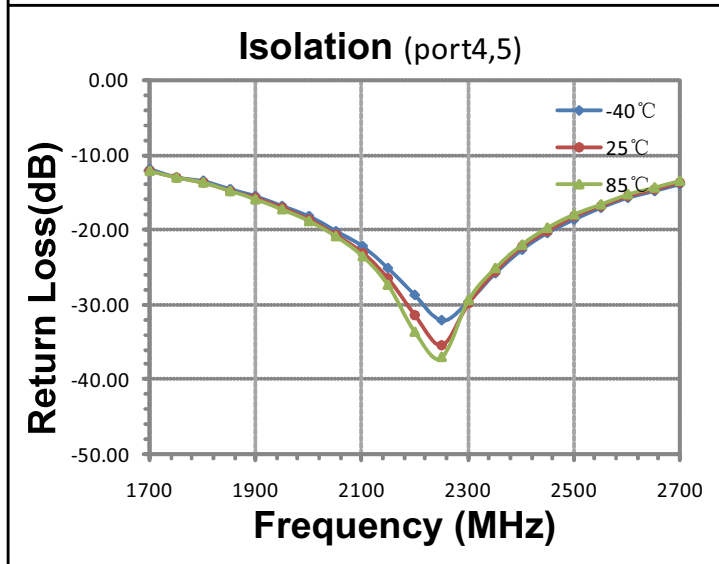
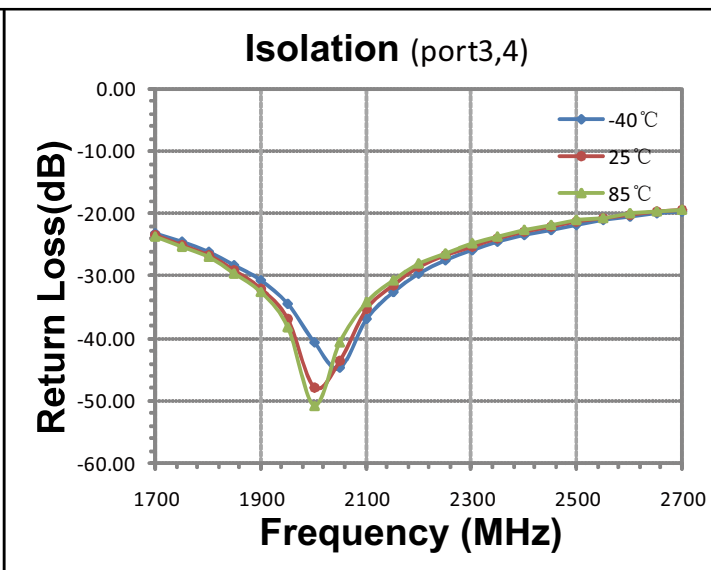
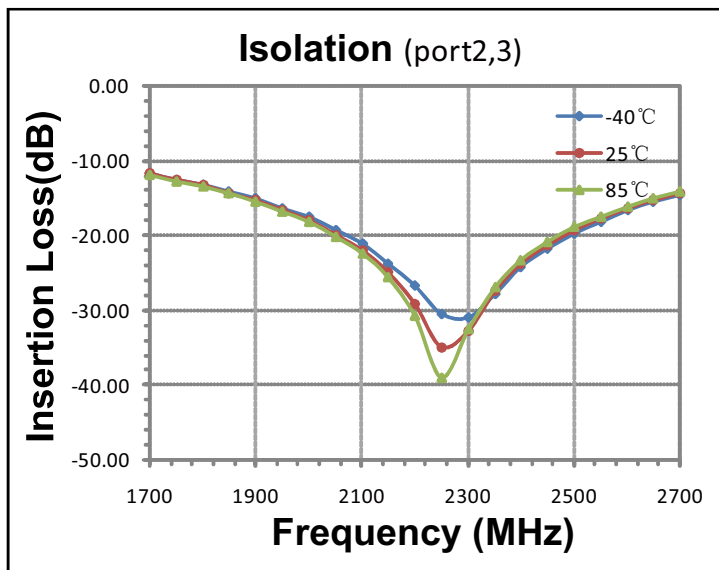

### Yantel Corporation

A3.0

Add: 3F, Building 3, Southern District 2 of Zhongguan Honghualing Industrial Park, Xili, Nanshan, Shenzhen, China

Tel: 86-755-8355-1886 Fax: 86-755-8355-2533

For detailed performance specs & shopping online see Yantel web site : [www.yantel-corp.com](http://www.yantel-corp.com)

# Data Sheet

## PD220U06-170

### Power Divider/Combiner

#### 4-Way 0° 50Ω 1.70-2.70 GHz



### Outline Drawing

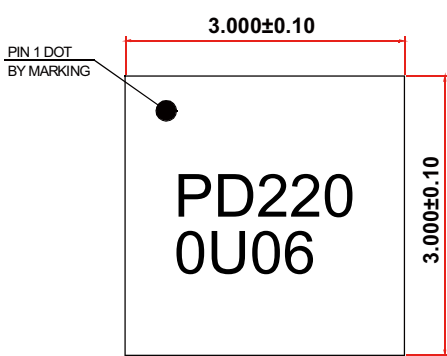

TOP VIEW

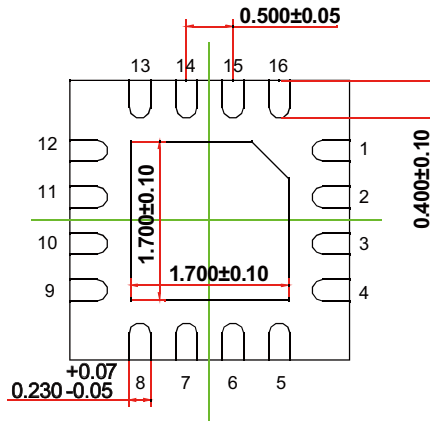

BOTTOM VIEW

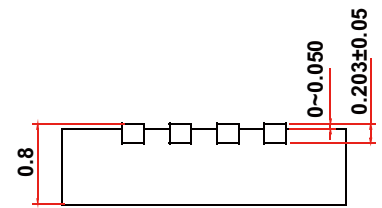

SIDE VIEW

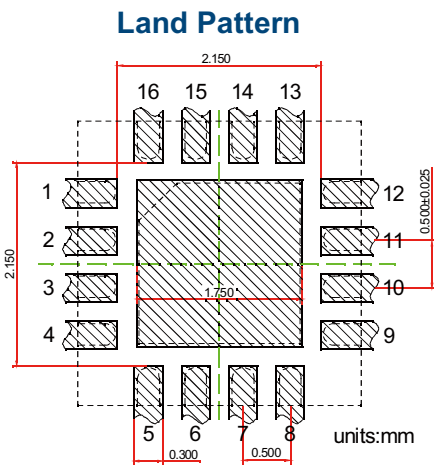

Recommended Land Pattern  
Top View

Notes: All dimensions show in millimeters

### Pin Out

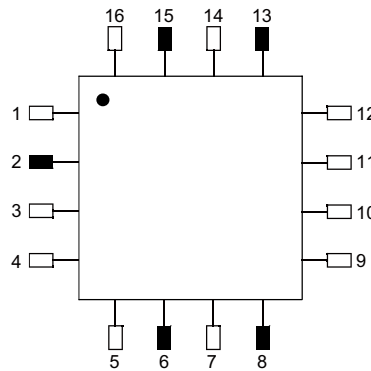

TOP VIEW

Notes:

1. Require to add Capacitors of DC Blocker between Pins (with black color) and external circuit to prevent DC signal entry to guarantee normal work.
2. This part has passed through 100% RF test.

Pin #	Connection
1	GND
2	PORT 1 (IN/SUM)
3	NC
4	GND
5	GND
6	PORT 2
7	NC
8	PORT 3
9	NC
10	GND
11	GND
12	NC
13	PORT 4
14	NC
15	PORT 5
16	GND
Center Pad	GND

### Yantel Corporation

A3.0 Add: 3F, Building 3, Southern District 2 of Zhongguan Honghualing Industrial Park, Xili, Nanshan, Shenzhen, China  
Tel: 86-755-8355-1886 Fax: 86-755-8355-2533

For detailed performance specs & shopping online see Yantel web site : [www.yantel-corp.com](http://www.yantel-corp.com)