

15W, wide input, isolated & regulated DC/DC converter

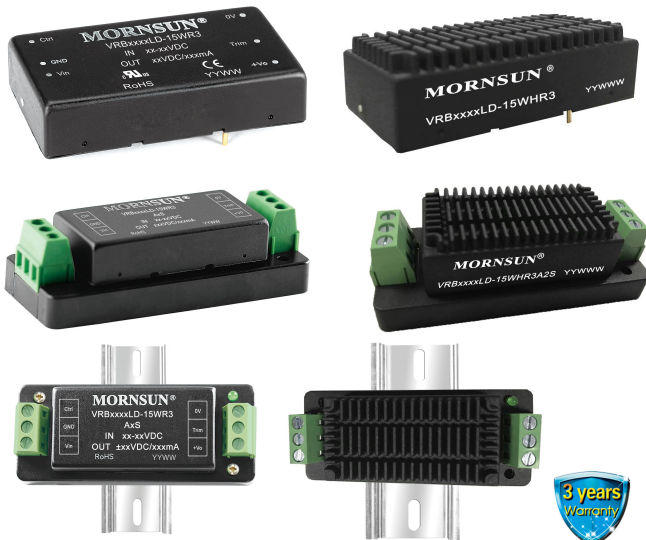

UL **CE** **CB** Patent Protection **RoHS**

FEATURES

- Wide input voltage range (2:1)
- High efficiency up to 90%
- No-load power consumption as low as 0.12W
- Isolation Voltage :1.5K VDC
- Input under-voltage protection, output short circuit, over-current, over-voltage protection
- Operating temperature range: -40°C to +85°C
- Meet CISPR32/EN55032 CLASS A, without external components
- Six-sided metal shielding package
- Reverse voltage protection available with A2S(Chassis mounting) or A4S(35mm DIN-Rail mounting)
- IEC60950, UL60950, EN60950 approval

VRB_LD-15WR3 series are isolated 15W DC-DC products with 2:1 input voltage. They feature efficiency up to 90%, 1500VDC isolation, operating temperature of -40°C to +85°C, Input under-voltage protection, output short circuit protection, over-voltage protection, over-current protection and EMI meets CISPR32/EN55032 CLASS A, which make them widely applied in data transmission device, battery power supplies, Tele-communication device, distributed power supply system, remote control system, industrial robot system fields. And extension package A2S and A4S also enable them with reverse voltage protection.

Selection Guide

Certification	Part No. ①	Input Voltage (VDC)		Output		Efficiency ^③ (%.Min./Typ.) @ Full Load	Max. Capacitive Load(μF)
		Nominal (Range)	Max. ②	Output Voltage (VDC)	Output Current (mA)(Max./Min.)		
UL/CE/CB	VRB2405LD-15WR3	24 (18-36)	40	5	3000/0	87/89	4700
	VRB2412LD-15WR3			12	1250/0	87/89	1000
	VRB2415LD-15WR3			15	1000/0	87/89	820
	VRB2424LD-15WR3			24	625/0	88/90	270
--	VRB4803LD-15WR3	48 (36-75)	80	3.3	4000/0	81/83	4700
UL/CE/CB	VRB4805LD-15WR3			5	3000/0	86/88	4700
	VRB4812LD-15WR3			12	1250/0	86/88	1000
	VRB4815LD-15WR3			15	1000/0	87/89	820
	VRB4824LD-15WR3			24	625/0	87/89	270

Notes: ①Series with suffix "H" are heat sink mounting; series with suffix "A2S" are chassis mounting, with suffix "A4S" are DIN-Rail mounting, for example VRB2405LD-15WHR3A2S is of chassis mounting package with heat sink,VRB2405LD-15WR3A4S is of DIN-Rail mounting without heat sink; If the application has a higher requirement for heat dissipation, we recommend modules with heat sink;
 ②Absolute maximum rating without damage on the converter, but it isn't recommended;
 ③Efficiency is measured in nominal input voltage and rated output load;A2S (wiring) and A4S (rail) Model due to input reverse polarity protection, minimum efficiency greater than Min.-2 is qualified.

Input Specifications

Item	Operating Conditions		Min.	Typ.	Max.	Unit
Input Current (full load / no-load)	24VDC input	5V output	--	702/30	718/75	mA
		Others	--	702/5	718/10	
	48VDC input	3.3V/5V output	--	355/20	363/30	
		Others	--	351/5	363/10	
Reflected Ripple Current	24VDC input		--	30	--	
	48VDC input		--	30	--	
Surge Voltage (1sec. max.)	24VDC input		-0.7	--	50	VDC
	48VDC input		-0.7	--	100	

Starting Voltage	24VDC input	--	--	18	VDC
	48VDC input	--	--	36	
Shutdown Voltage	24VDC input	12	15.5	--	
	48VDC input	26	30	--	
Starting Time	Nominal input voltage & constant resistance load	--	10	--	ms
Input Filter		Pi filter			
Ctrl*	Module switched on	Ctrl pin suspended or connected to TTL high level (3.5-12VDC)			
	Module switched off	Ctrl pin connected to GND or low level (0-1.2VDC)			
	Input current when switched off	--	4	7	mA
Hot Plug		Unavailable			

Note: *The voltage of Ctrl pin is relative to input pin GND.

Output Specifications

Item	Operating Conditions	Min.	Typ.	Max.	Unit	
Output Voltage Accuracy	0% -100% load	--	±1	±3	%	
Line Regulation	Full load, the input voltage is from low voltage to high	--	±0.2	±0.5		
Load Regulation	Nominal input voltage	--	±0.5	±1		
Transient Recovery Time		--	300	500	μs	
Transient Response Deviation	25% load step change, Nominal input voltage	3.3V output	--	±5	±8	%
		Others	--	±3	±5	
Temperature Coefficient	Full load	--	--	±0.03	%/°C	
Ripple & Noise*	20MHz bandwidth, 5% -100% load	--	50	100	mVp-p	
Trim	Input voltage range	90	--	110	%Vo	
Over-voltage Protection		110	--	160		
Over-current Protection		110	--	190	%Io	
Short circuit Protection		Hiccup, Continuous, self-recovery				

Note: *Ripple and noise are measured by "parallel cable" method, please see DC-DC Converter Application Notes for specific operation.
0%-5% load ripple&Noise is no more than 5%Vo.

General Specifications

Item	Operating Conditions	Min.	Typ.	Max.	Unit	
Isolation Voltage	Input-output, with the test time of 1 minute and the leak current lower than 1mA	1500	--	--	VDC	
Insulation Resistance	Input-output, insulation voltage 500VDC	1000	--	--	MΩ	
Isolation Capacitance	Input-output, 100KHz/0.1V	VRB2424LD-15W(H)R3(A2S/A4S) VRB4824LD-15W(H)R3(A2S/A4S)	--	2050	--	pF
		Others	--	1050	--	
Operating Temperature	see Fig. 1	-40	--	+85	°C	
Storage Temperature		-55	--	+125		
Storage Humidity	Non-condensing	5	--	95	%RH	
Pin Welding Resistance Temperature	Welding spot is 1.5mm away from the casing, 10 seconds	--	--	300	°C	
Vibration		10-55Hz, 10G, 30 Min. along X, Y and Z				
Switching Frequency *	PWM mode	--	270	--	KHz	
MTBF	MIL-HDBK-217F@25°C	1000	--	--	K hours	

Note: * This series of products employ the technique of lower frequency, the switching frequency is tested with full load, When the load is being reduced to below 50%, the switching frequency decreases accordingly.

Physical Specifications

Casing Material		Aluminum alloy
Package Dimensions	Horizontal package(without heat sink)	50.80*25.40*11.80 mm
	Horizontal package(with heat sink)	51.40*26.20*16.50 mm
	A2S wiring package (without heat sink)	76.00*31.50*21.20 mm
	A2S wiring package(with heat sink)	76.00*31.50*25.30 mm
	A4S rail package(without heat sink)	76.00*31.50*25.80 mm
	A4S rail package(with heat sink)	76.00*31.50*29.90 mm
Weight	without heat sink	Horizontal package/A2S wiring package/A4S rail package 26g/48g/68g(Typ.)
	with heat sink	Horizontal package/A2S wiring package/A4S rail package 34g/56g/76g(Typ.)
Cooling Method		Free air convection

EMC Specifications

EMI	CE	Others	CISPR32/EN55032 CLASS A (without external components)/ CLASS B (see Fig.3-② for recommended circuit)
		3.3V output	CISPR32/EN55032 CLASS B (see Fig.3-② for recommended circuit)
	RE	Others	CISPR32/EN55032 CLASS A (without external components)/ CLASS B (see Fig.3-② for recommended circuit)
		3.3V output	CISPR32/EN55032 CLASS B (see Fig.3-② for recommended circuit)
EMS	ESD		IEC/EN61000-4-2 Contact $\pm 4KV$ perf. Criteria B
	RS		IEC/EN61000-4-3 10V/m perf. Criteria A
	EFT		IEC/EN61000-4-4 $\pm 2KV$ (see Fig.3-① for recommended circuit) perf. Criteria B
	Surge		IEC/EN61000-4-5 line to line $\pm 2KV$ (see Fig.3-① for recommended circuit) perf. Criteria B
	CS		IEC/EN61000-4-6 3 Vr.m.s perf. Criteria A
	Immunities of voltage dip, drop and short interruption		IEC/EN61000-4-29 0%, 70% perf. Criteria B

Product Characteristic Curve

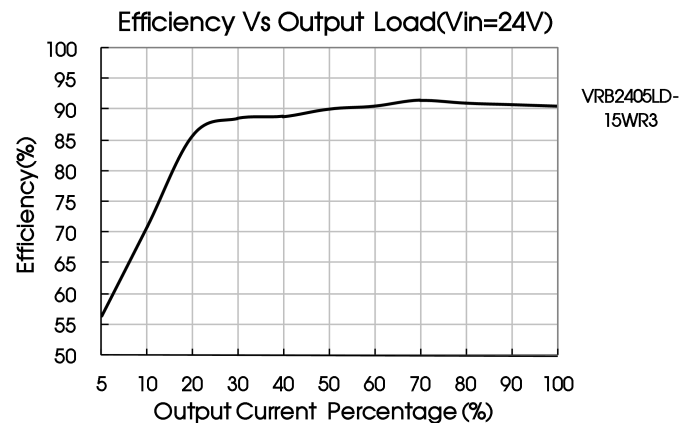
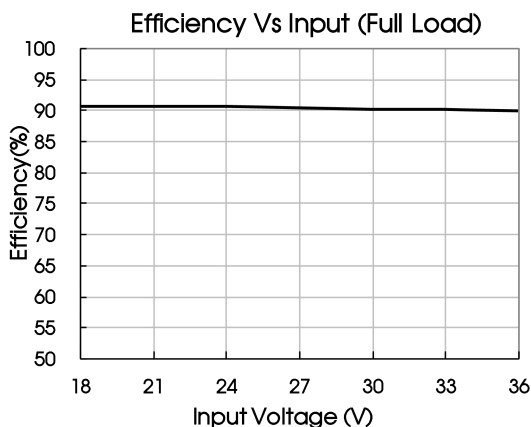
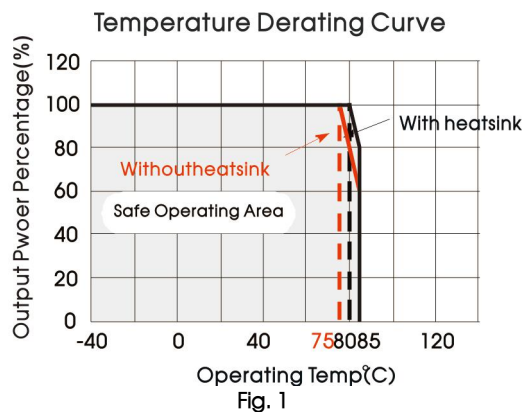

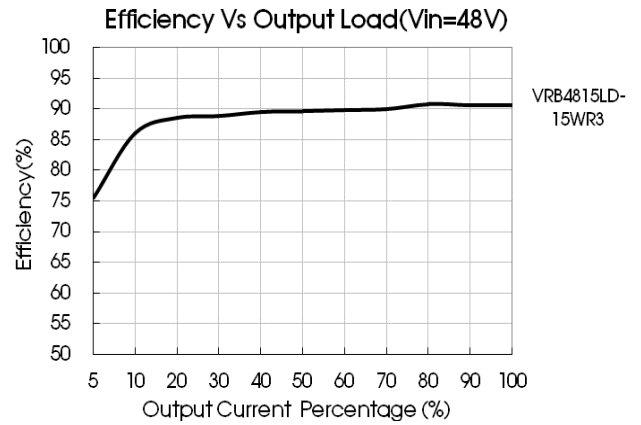
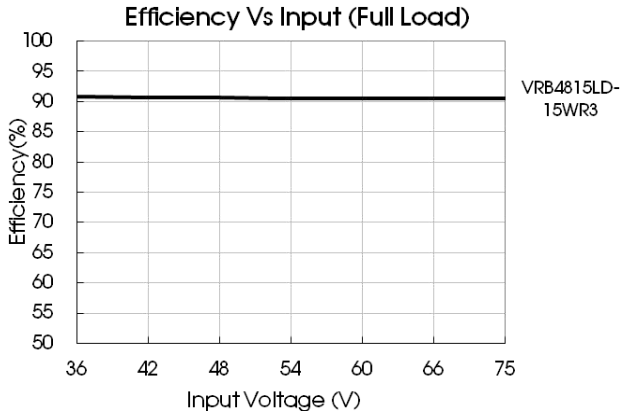

Design Reference

1. Typical application

All the DC/DC converters of this series are tested according to the recommended circuit (see Fig. 2) before delivery. If it is required to further reduce input and output ripple, properly increase the input & output of additional capacitors Cin and Cout or select capacitors of low equivalent impedance provided that the capacitance is no larger than the max. capacitive load of the product.

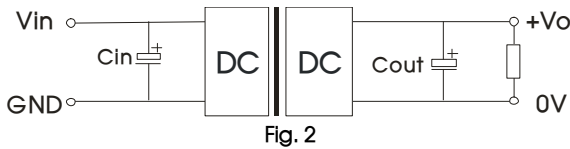

Vout (VDC)	Cout (μF)	Cin (μF)
3.3/5	470	100
12/15	220	
24	100	

2. EMC solution-recommended circuit

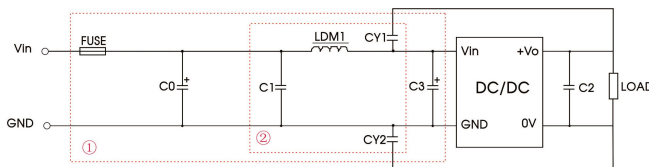

Fig. 3

Notes: Part ① in the Fig. 3 is used for EMS test and part ② for EMI filtering; selected based on needs.

Parameter description

Model	Vin:24V	Vin:48V
FUSE	Choose according to actual input current	
C0/C3	330μF/50V	330μF/100V
C1	1μF/50V	4.7μF/100V
C2	Refer to the Cout in Fig.2	
LDM1	4.7μH/2.2A	
CY1/CY2	1nF/2KV	

3. Application of Trim and the calculation of Trim resistance

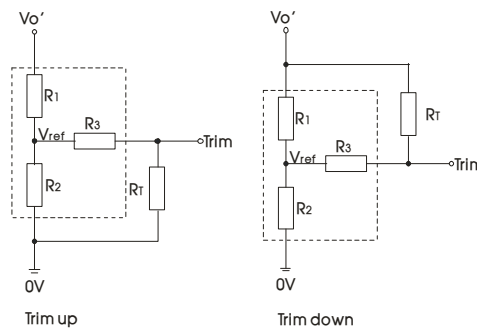

Applied circuits of Trim (Part in broken line is the interior of models)

Calculation formula of Trim resistance:

$$\begin{aligned} \text{up: } R_T &= \frac{\alpha R_2}{R_2 - \alpha} - R_3 & \alpha &= \frac{V_{ref}}{V_o' - V_{ref}} \cdot R_1 \\ \text{down: } R_T &= \frac{\alpha R_1}{R_1 - \alpha} - R_3 & \alpha &= \frac{V_o' - V_{ref}}{V_{ref}} \cdot R_2 \end{aligned}$$

R_T is Trim resistance
α is a self-defined parameter, with no real meaning.

Vout(V)	R1(KΩ)	R2(KΩ)	R3(KΩ)	Vref(V)
3.3	4.801	2.87	12.4	1.24
5	2.883	2.87	10	2.5
12	11.000	2.87	15	2.5
15	14.494	2.87	15	2.5
24	24.872	2.87	17.8	2.5

- It is not allowed to connect modules output in parallel to enlarge the power
- For more information please find DC-DC converter application notes on www.mornsun.com

Horizontal Package (without heat sink) Dimensions and Recommended Layout

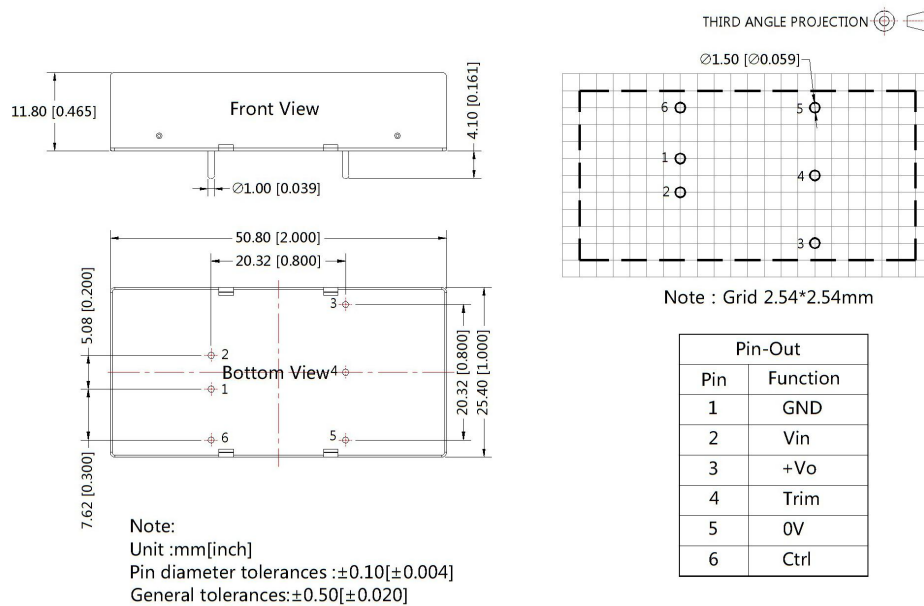

Horizontal Package (with heat sink) Dimensions

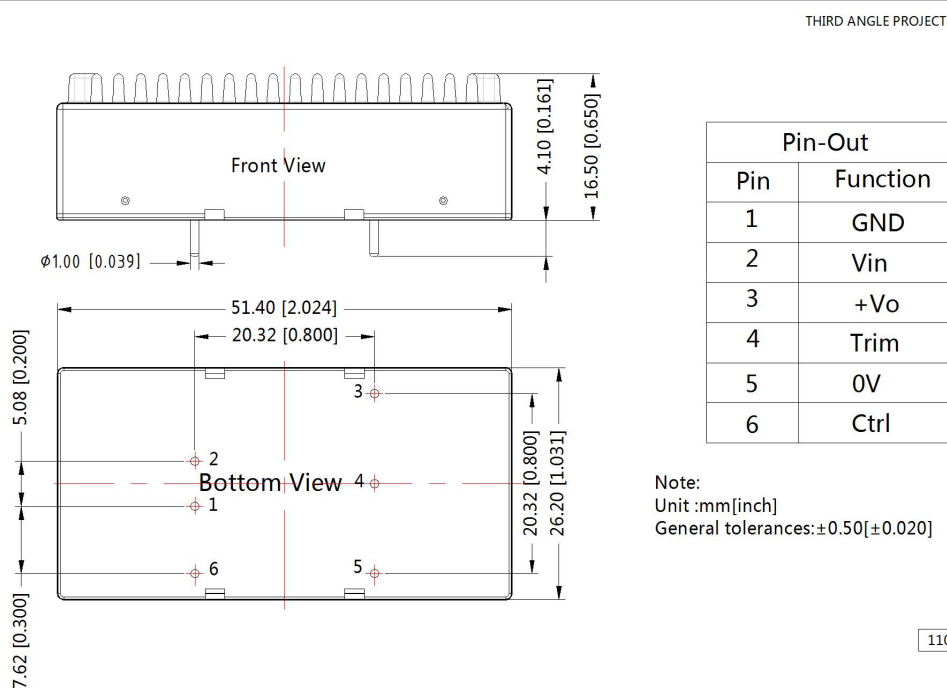

VRB_LD-15WR3A2S(without heat sink) Dimensions

THIRD ANGLE PROJECTION 

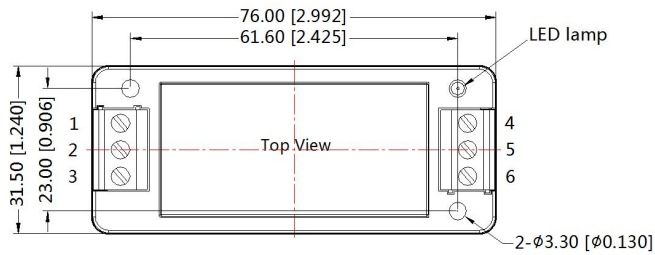

Pin-Out						
Pin	1	2	3	4	5	6
Dual	Ctrl	GND	Vin	-Vo	0V	+Vo
Single	Ctrl	GND	Vin	0V	Trim	+Vo

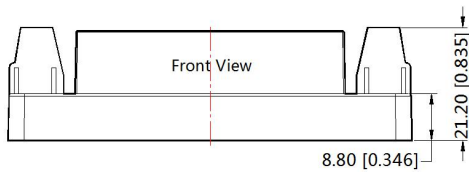

Note:
Unit: mm[inch]
Wire range: 24-12 AWG
Tightening torque: Max 0.4 N·m
General tolerances: ±0.50[±0.020]

VRB_LD-15WHR3A2S(with heat sink) Dimensions

THIRD ANGLE PROJECTION 

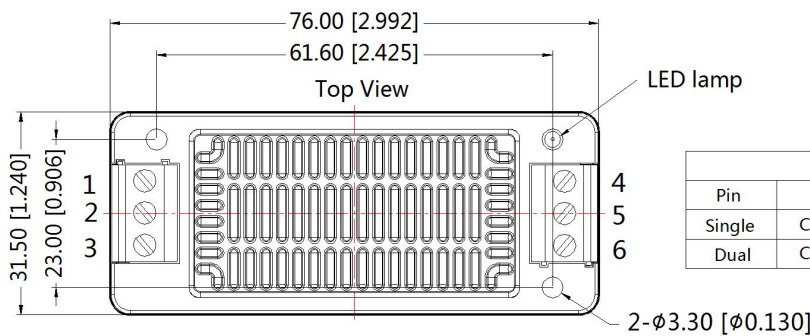

Pin-Out						
Pin	1	2	3	4	5	6
Single	Ctrl	GND	Vin	0V	Trim	+Vo
Dual	Ctrl	GND	Vin	-Vo	0V	+Vo

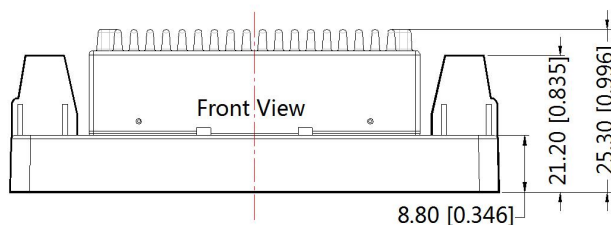

Note:
Unit: mm[inch]
Wire range: 24-12 AWG
Tightening torque: Max 0.4 N·m
General tolerances: ±0.50[±0.020]

VRB_LD-15WR3A4S(without heat sink) Dimensions

THIRD ANGLE PROJECTION 

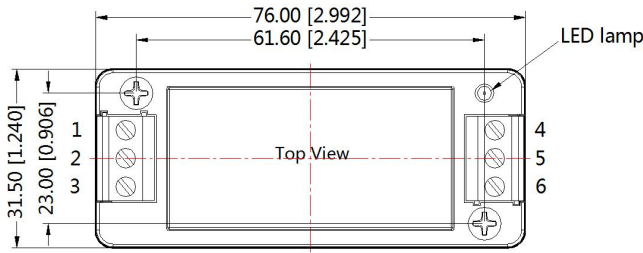

Pin-Out						
Pin	1	2	3	4	5	6
Dual	Ctrl	GND	Vin	-Vo	0V	+Vo
Single	Ctrl	GND	Vin	0V	Trim	+Vo

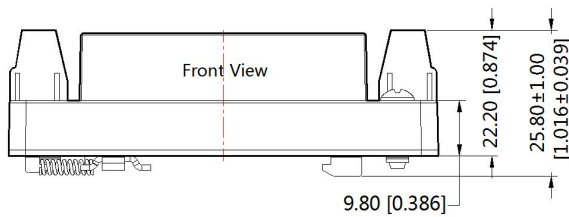

Note:
Unit: mm[inch]
Wire range: 24-12 AWG
Tightening torque: Max 0.4 N·m
General tolerances: ±1.00[±0.039]

VRB_LD-15WHR3A4S(with heat sink) Dimensions

THIRD ANGLE PROJECTION 

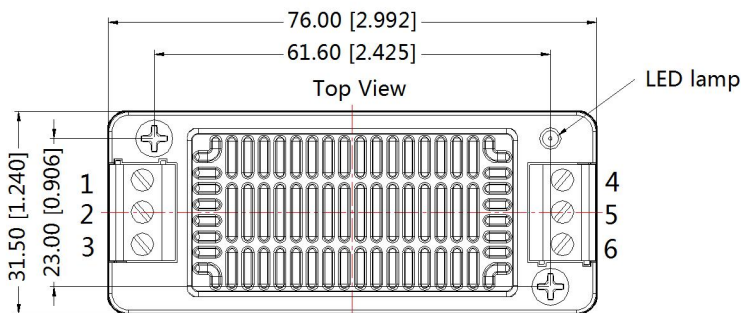

Pin-Out						
Pin	1	2	3	4	5	6
Single	Ctrl	GND	Vin	0V	Trim	+Vo
Dual	Ctrl	GND	Vin	-Vo	0V	+Vo

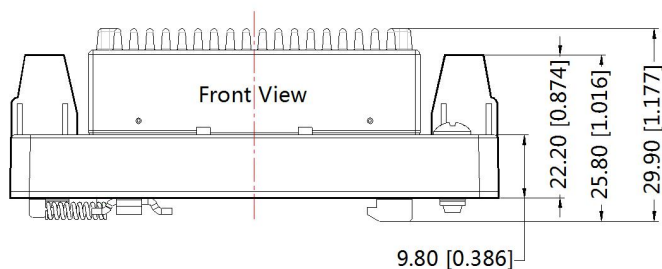

Note:
Unit: mm[inch]
Mounting rail: TS35
Wire range: 24-12 AWG
Tightening torque: Max 0.4 N·m
General tolerances: ±1.00[±0.039]

Notes:

1. Packing information please refer to Product Packing Information which can be downloaded from www.mornsun-power.com. The Packing bag number of Horizontal package :58200035(without heat sink), 58200051(with heat sink), A2S/ A4S package number: 58220022;
2. The maximum capacitive load offered were tested at input voltage range and full load;
3. Unless otherwise specified, parameters in this datasheet were measured under the conditions of Ta=25°C, humidity<75%RH with nominal input voltage and rated output load;
4. All index testing methods in this datasheet are based on Company's corporate standards;
5. We can provide product customization service, please contact our technicians directly for specific information;
6. Products are related to laws and regulations: see "Features" and "EMC";
7. Our products shall be classified according to ISO14001 and related environmental laws and regulations, and shall be handled by qualified units.

Mornsun Guangzhou Science & Technology Co., Ltd.

Address: No. 5, Kehui St. 1, Kehui Development Center, Science Ave., Guangzhou Science City, Luogang District, Guangzhou, P. R. China
Tel: 86-20-38601850-8801 Fax: 86-20-38601272 E-mail: info@mornsun.cn