

# Amphenol® Tri-Start™ Subminiature Cylindrical Connectors

12-092-14

**MIL-DTL-38999, Series III**

- Aluminum
- Stainless Steel/Firewall
- Composite
- Clutch-Lok® High Vibration

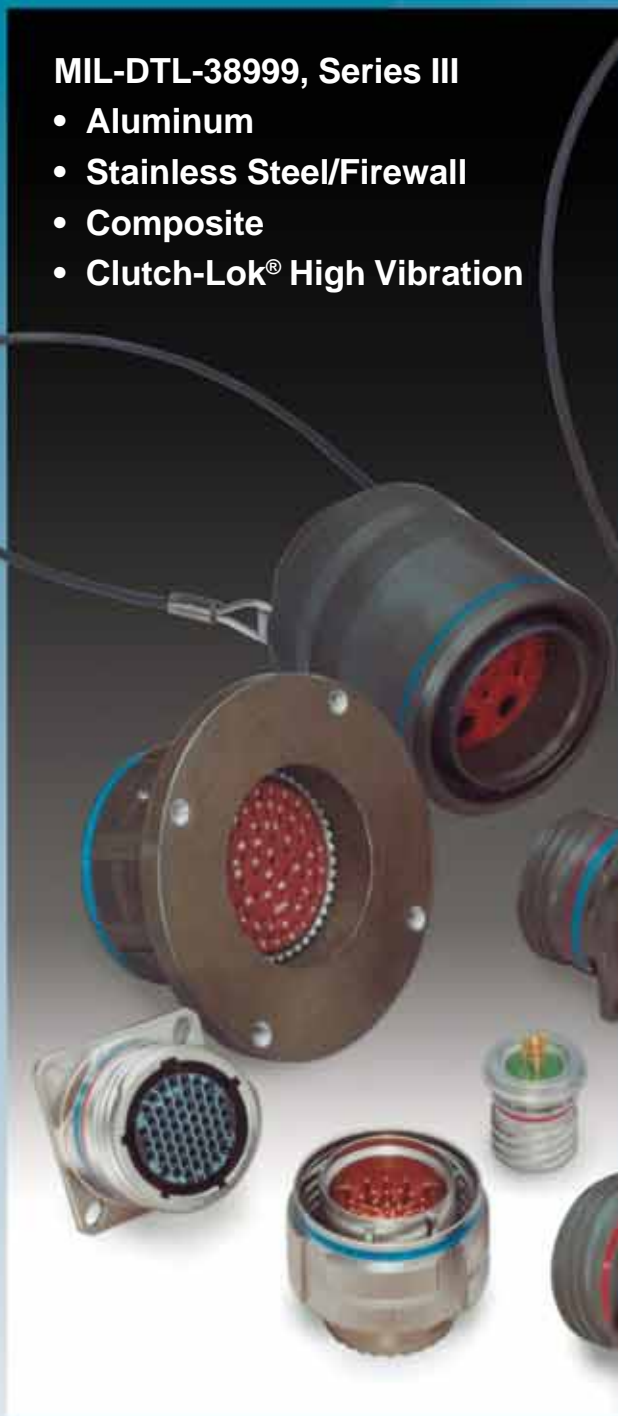

**Amphenol**

| <b>Table of Contents</b>  | <b>Page No.</b> |
|---|-----------------|
| Series III - The Highest Performance MIL-DTL-38999 Connector .....  | 1               |
| Tri-Start Series III Versatility and Options .....  | 2               |
| Shell Styles and Key Design Features .....  | 3               |
| Test Data .....   | 4               |
| Specifications .....  | 5               |
| Insert Availability and Identification .....  | 6, 7            |
| Alternate Positioning .....   | 8               |
| Insert Arrangements .....   | 9-15            |
| <b>Crimp</b>  |                 |
| TVP00R/CTVP00R Wall Mounting Receptacle .....   | 16              |
| TVP02R/CTVP02R Box Mounting Receptacle .....  | 17              |
| TV06R/CTV06R Straight Plug .....  | 18              |
| TV26/MTV26 CLUTCH-LOK® Straight Plug .....  | 19              |
| TV07R/CTV07R Jam Nut Receptacle .....   | 20              |
| TV01R/CTV01R Line Receptacle .....  | 21              |
| TV09R Flange Mounting Plug .....  | 22              |
| <b>Hermetic</b>   |                 |
| TVPS02Y Box Mounting Receptacle .....   | 23              |
| TVS07Y Jam Nut Receptacle .....   | 24              |
| TVSIY Solder Mounting Receptacle .....  | 25              |
| TVSHIY Weld Mounting Receptacle .....   | 26              |
| <b>Fail Safe, Lanyard Release</b>   |                 |
| Design Features, Types .....  | 27              |
| D38999/29, D38999/30 Lanyard Release Plug .....   | 28-30           |
| D38999/31 TV Fail Safe Lanyard Release Plug for MIL-STD-1760 .....  | 31, 32          |
| Accessories for Lanyard Release Connectors .....  | 33              |
| <b>Accessories</b>  |                 |
| Receptacle Protection Caps .....  | 34              |
| Plug Protection Caps .....  | 35              |
| Dummy Receptacles .....   | 36              |
| Cable Clamps .....  | 37              |
| Universal Header Assembly for Flex Print or PC Board Connectors .....   | 38, 39          |
| <b>Contacts, Sealing Plugs, Plastic/Metal Protection Caps .....</b>   | <b>40</b>       |
| <b>Contacts (Printed Circuit Board, Wire wrap) .....</b>  | <b>41</b>       |
| <b>Application Tools .....</b>  | <b>42</b>       |
| <b>How to Order</b>   |                 |
| Amphenol® TV, Metal and Amphenol® TV26 CLUTCH-LOK® .....  | 43              |
| D38999, TV Military, Metal and MTV26 CLUTCH-LOK® .....  | 44              |
| Amphenol® CTV, Composite .....  | 45              |
| D38999, CTV Military, Composite .....   | 46              |
| <b>Composite Weight Comparisons .....</b>   | <b>47</b>       |
| <b>Specials (Fiber Optics, Filter Protection, Flex Assemblies, PCB Applications) .....</b>  | <b>48</b>       |
| <b>Specials (Coax, Twinax, Triax Contacts, Ground Plane Connectors, Press Fit Connectors) .....</b>   | <b>49</b>       |
| <b>Specials (Quadrax Contacts) .....</b>  | <b>50</b>       |
| <b>Specials (Deep Reach Shells, Stand-off Flange Shells, Connectors with Integral Strain Reliefs, ESD Protection, RJ Field Connectors .....</b> | <b>51</b>       |
| <b>Sales Office and Distributor Listing .....</b>   | <b>52</b>       |

For additional information concerning Amphenol Tri-Start Connectors, or if there are special application requirements, contact your local sales office or

Amphenol Aerospace  
40-60 Delaware Ave.  
Sidney, New York 13838-1395  
Phone: 607-563-5011 Fax: 607-563-5157  
[www.amphenol-aerospace.com](http://www.amphenol-aerospace.com)

**Amphenol Aerospace is a Certified ISO9001 Manufacturer.**



# Amphenol® Tri-Start Series III - the highest performance MIL-DTL-38999 connector



**Tri-Start™ MIL-DTL-38999 Series III  
with Metal Shells - Aluminum, Stainless Steel, Class K Firewall**

Amphenol® Tri-Start MIL-DTL-38999\* Series III Connectors offer the highest performance capabilities for both general duty and severe environment applications. Meeting or exceeding MIL-DTL-38999 Series III requirements, the Tri-Start connector with standard metal shells (aluminum or stainless steel with several finish options) offers these features:

- **EMI Shielding** - solid metal to metal coupling, grounding fingers, electroless nickel plating, and thicker wall sections provide superior EMI shielding capability of 65dB minimum at 10 GHz
- **Contact Protection** - recessed pins in this 100% scoop-proof connector minimize potential contact damage
- **Moisture Resistance** - improved interfacial seal design helps prevent electrolytic erosion of contacts
- **Corrosion Resistance** - shells of stainless steel or cadmium over nickel plating withstand a 500 hour salt spray exposure
- **Vibration/Shock** - operates under severe high temperature vibration, through 200°C
- **Firewall Capability** - available in a stainless steel shell, class RK, RS
- **Lockwiring Eliminated** - unique, self-locking, quick coupling connector eliminates lockwiring
- **Quick Coupling** - completely mates and self-locks in a 360° turn of the coupling nut
- **Inventory Support Commonality** - uses standard MIL-DTL-38999 contacts, application tools, insert arrangements
- **Electrostatic Discharge Protection (ESD)** - protection for sensitive circuitry without diodes, varistors, etc., with the use of the Faraday Cage principal which shunts high voltage, high current discharge events (see page 51)
- **Ground Plane Connectors** - with metallic insert for common grounding of coax, triax or twinax contact outer shield (see page 49)
- **Hermetic**- air leakage limited to  $1 \times 10^{-7}$  cm<sup>3</sup> per second optional

\* MIL-DTL-38999 Series III supersedes MIL-C-38999 Series III.



**Composite Tri-Start,  
Qualified to MIL-DTL-38999, Rev. J**

MIL-Qualified to MIL-DTL-38999, Rev. K, the Amphenol® Composite Tri-Start Connector offers a lightweight, corrosion resistant connector with the same high performance features as its metal counterpart. The Composite Tri-Start Connector also includes the following features:

- **Lightweight** - 17% – 70% weight savings (17–40% weight savings vs. aluminum) (60–70% weight savings vs. stainless steel) See Composite weight comparison chart, pg. 47.
- **Corrosion Resistance** - available in standard MIL-DTL-38999 olive drab cadmium (175°C) and electroless nickel plating (200°C), both withstanding 2000 hours of salt spray exposure. The base material is able to withstand an indefinite exposure to salt spray.
- **Durability** - 1500 couplings minimum (in reference to connector couplings, not contacts)
- **Extended Life Contact** - Mil-approved plating process which provides 1500 couplings minimum



**CLUTCH-LOK™ MIL-DTL-38999 Series III  
High Vibration Connector**

The latest offering from Amphenol in MIL-DTL-38999, the CLUTCH-LOK connector offers:

All advantages of stainless steel/Class K firewall Tri-Start connectors plus a unique clutch design that actually tightens itself under vibration.

Features include:

- High degree of differential torque
- No settling back to the next ratchet tooth
- Completely intermateable with all existing MIL-DTL-38999 Series III connectors
- Offers advantage in inaccessible, hard to reach areas where mating torque is difficult to apply and complete coupling is not verifiable by inspection See page 19 for description, 43 and 44 for ordering.

# Amphenol® Tri-Start

offers more versatility & options  
than any other interconnection family

**The Tri-Start Connector is the high performance choice in the D38999 Family.**

Originally designed in order to increase the performance levels of MIL-DTL-38999 Series I and II, the Series III was created to meet high performance connector criteria.

Dynamic features for performance and reliability that were needed for military, aerospace and ground vehicle applications were designed into the Series III that include:

- Rapid coupling via a triple-start thread
- Shell-to-shell or metal-to-metal bottoming
- Improved EMI shielding

The Tri-Start Family of connectors has grown and expanded since its original addition to the 38999 series in order to meet ever-evolving interconnection product needs. Today, the Tri-Start family has styles and options that cover a very wide range to meet not only the highest performance needs of space applications, but also general duty connector needs.

**The Tri-Start Connector Series is second to none in terms of versatility and customer options.**

The broad portfolio includes Tri-Starts with:

- Aluminum and nickel plated stainless steel shells
- Class K Firewalls
- Composite shells
- Clutch-Lok® high vibration design
- Fiber Optics
- Fail-Safe Lanyard Release connectors
- Variety of contact options: shielded, coax, matched impedance coax, triax, twinax, quadrax, thermocouple, PCB tail and wire wrap
- Ground plane versions and Press-fit® with compliant pins
- ESD (Electrostatic Discharge) protection
- Filter/Transient protection
- Hermetic versions
- Long reach receptacle styles
- Numerous shell geometries, finishes and accessories

See more on Tri-Start specials on pages 48-51.



Fiber Optic Multi-Channel D38999



MIL-DTL-38999 with Shielded Coax Contacts



D38999 Ground Plane with Metallic Insert, Power Contacts and Shielded Twinax Contacts



Filter/Transient Protection MIL-DTL-38999 Series III



D38999 with Flex Termination for Attachment to PCB Boards



Hermetic Tri-Start MIL-DTL-38999 Series III



MIL-DTL-38999 Lanyard "Breakaway" Connector Qualified for MIL-STD-1760



D38999 with PC Tail Coax Contacts and Alignment Disc

# Amphenol® Tri-Start shell styles and key design features



## Designed for Performance

Numerous advantages in performance capability are designed into the Amphenol Tri-Start Connector. A positive metal to metal coupling design, grounding fingers, and electroless nickel plating provide superior EMI shielding capability of 65 dB minimum at 10 GHz.

Acme threads provide coupling durability. Thicker wall sections and a greater coupling surface area improve strength and shock resistance. Blunting of the thread on both the coupling nut and receptacle eliminates cross coupling. The connector quickly mates and self locks in a 360° turn of the coupling nut.

Elongated mounting holes permit the Tri-Start Connector to intermount with various existing MIL-spec box or wall mount receptacles, giving it a design replacement advantage.

Shells of stainless steel, or cadmium over nickel plating prevent severe corrosion. Resistance is tested through exposure to a 500 hour salt spray. Composite versions provide protection from salt spray exposure for 2000 hours. Other finish options are available; see how to order Tri-Start metal and Tri-Start Composite.

Recessed pins minimize potential contact damage in this 100% scoop-proof connector. In a blind mating application, mating shells cannot “scoop” the pins and cause a shorting or bending of contacts.

The design of the Amphenol Tri-Start interfacial seal meets the MIL-DTL-38999 Series III requirements for electrolytic erosion resistance.

A rigid dielectric insert with excellent electrical characteristics provides durable protection to the contacts. The socket contacts are probe proof, and all contacts are rear removable. They are plated in the standard 50 micro inches minimum gold, with 100 micro inches as an option and are available in standard Tri-Start insert arrangements and special Pyle® insert arrangements in sizes 10 power, 12, 16, 20 and 22D contacts. Special insert patterns are also available with larger contacts in sizes 4 and 0.

### Applicable Patents:

Tri-Start™ Connector Patent 4,109,990.

Composite Connector Patents:

4,268,103; 4,648,670; 4,682,832; 4,703,987.

Clutch-Lok® Patent 6,152,753.

# Tri-Start test data

**TRI-START, SERIES III**  
**TYPICAL SHIELDING EFFECTIVENESS TEST DATA**  
EMI/EMP SHIELDING EFFECTIVENESS dB  
TESTING BY TRIAXIAL METHOD



**TRI-START, SERIES III**  
**TYPICAL SHIELDING EFFECTIVENESS TEST DATA**  
EMI/EMP SHIELDING EFFECTIVENESS dB  
TESTING BY MODE STIRRING METHOD



Amphenol® Tri-Start connectors provide EMI/EMP shielding capability which exceeds MIL-DTL-38999 Series III requirements.

The TV and CTV Series III connector with standard solid metal to metal coupling, EMI grounding fingers and conductive finishes has proven to be the ultimate in EMI/EMP shielding effectiveness. The charts illustrate shielding effectiveness data which is typical of Tri-Start connectors tested with the nickel finish (Class F-metal, Class M-composite) over a wide frequency range.

The vibration capability of the Tri-Start Series is shown in the chart below. This illustrates the most severe vibration envelope of any qualified connector available today.

These capabilities along with a 200°C temperature rating and superior moisture sealing protection provide the user with a connector that can withstand the most rigorous application.

**TRI-START**  
**VIBRATION CRITERIA**



\* Dependant on shell finish

Test data beyond 2GHz is subject to equipment variation.

NOTE: for test data information on the new Clutch-Lok Tri-Start, high vibration connectors, consult Amphenol Aerospace.

# Tri-Start specifications

## CONTACT RATING

| Contact Size | Test Current (Amps) |          | Maximum Millivolt Drop Crimp* | Maximum Millivolt Drop Hermetic* |
|--------------|---------------------|----------|-------------------------------|----------------------------------|
|              | Crimp               | Hermetic |                               |                                  |
| 22D          | 5                   | 3        | 73                            | 85                               |
| 20           | 7.5                 | 5        | 55                            | 60                               |
| 16           | 13                  | 10       | 49                            | 85                               |
| 12           | 23                  | 17       | 42                            | 85                               |
| 10 (Power)   | 33                  | NA       | 33                            | NA                               |
| 8 (Power)    | 46                  | NA       | 26                            | NA                               |
| 4            | 80                  | NA       | 23                            | NA                               |
| 0            | 150                 | NA       | 21                            | NA                               |

\* When using silver plated wire.

| Contact Size | Crimp Well Data |                    | Hermetic Data       |                 |
|--------------|-----------------|--------------------|---------------------|-----------------|
|              | Well Diameter   | Nominal Well Depth | Well Diameter       | Min. Well Depth |
| 22D          | .0345 ± .0010   | .141               | .036 +.004<br>-.000 | .094            |
| 20           | .047 ± .001     | .209               | .044 +.004<br>-.000 | .125            |
| 16           | .067 ± .001     | .209               | .078 +.004<br>-.002 | .141            |
| 12           | .100 ± .002     | .209               | .116 +.004<br>-.002 | .141            |
| 10 (Power)   | .137 ± .002     | .355               | NA                  | NA              |
| 8            | .181 ± .002     | .490               | NA                  | NA              |
| 4            | .281 ± .002     | .490               | NA                  | NA              |
| 0            | .453 ± .002     | .585               | NA                  | NA              |

## SERVICE RATING

| Service Rating | Suggested Oper. Voltage (Sea Level) |      | Test Voltage (Sea Level) | Test Voltage 50,000 Ft. | Test Voltage 70,000 Ft. | Test Voltage 110,000 Ft. |
|----------------|-------------------------------------|------|--------------------------|-------------------------|-------------------------|--------------------------|
|                | AC (RMS)                            | DC   |                          |                         |                         |                          |
| M              | 400                                 | 550  | 1300 VRMS                | 550 VRMS                | 350 VRMS                | 200 VRMS                 |
| N              | 300                                 | 450  | 1000 VRMS                | 400 VRMS                | 260 VRMS                | 200 VRMS                 |
| I              | 600                                 | 850  | 1800 VRMS                | 600 VRMS                | 400 VRMS                | 200 VRMS                 |
| II             | 900                                 | 1250 | 2300 VRMS                | 800 VRMS                | 500 VRMS                | 200 VRMS                 |

Please note that the establishment of electrical safety factors is left entirely in the designer's hands, since he is in the best position to know what peak voltage, switching surges, transients, etc. can be expected in a particular circuit.

## FINISH DATA

| Non-Hermetic Shell Components        |               |             |
|--------------------------------------|---------------|-------------|
| Finish                               | Service Class |             |
|                                      | Military      | Proprietary |
| Anodic Coating (Non-Conductive)      | C             | RX**        |
| Electroless Nickel                   | F (Metal)     | RF          |
|                                      | M (Composite) |             |
| Olive Drab Cadmium Plate Nickel Base | W (Metal)     | RW          |
|                                      | J (Composite) |             |
| Stainless Steel with Nickel Plate    | S             | RS          |
| Stainless Steel                      | K             | RK          |

\*\* Add Suffix (005) to part number.

| Hermetic Shell Components         |               |             |
|-----------------------------------|---------------|-------------|
| Material / Finish                 | Service Class |             |
|                                   | Military      | Proprietary |
| Stainless Steel                   | Y             | Y           |
| Stainless Steel with Nickel Plate | N             | YN          |

# Tri-Start

## insert availability and identification

### AMPHENOL TRI-START INSERT ARRANGEMENTS

| Shell Size/Arrg. | Military Shell | Crimp | Hermetics* | Service Rating | Total Contacts | Contact Size |    |     |    |           |            |          |              |   |
|------------------|----------------|-------|------------|----------------|----------------|--------------|----|-----|----|-----------|------------|----------|--------------|---|
|                  |                |       |            |                |                | 22D          | 20 | 16  | 12 | 12 (Coax) | 10 (Power) | 8 (Coax) | 8†† (Twinax) |   |
| 9-5★■            | A              |       |            | Grounded       | 1              |              |    |     |    |           |            |          |              | 1 |
| 9-35             | A              | X     | P          | M              | 6              | 6            |    |     |    |           |            |          |              |   |
| 9-94■            | A              | ◆     |            | M              | 2              |              | 2  |     |    |           |            |          |              |   |
| 9-98             | A              | X     | P          | I              | 3              |              | 3  |     |    |           |            |          |              |   |
| 11-2★            | B              | ◆     |            | I              | 2              |              |    | 2   |    |           |            |          |              |   |
| 11-5             | B              | ◆     | P          | I              | 5              |              | 5  |     |    |           |            |          |              |   |
| 11-35            | B              | X     | P          | M              | 13             | 13           |    |     |    |           |            |          |              |   |
| 11-54■           | B              | X     |            | II             | 4              | 4            |    |     |    |           |            |          |              |   |
| 11-98            | B              | X     | P          | I              | 6              |              | 6  |     |    |           |            |          |              |   |
| 11-99            | B              | X     |            | I              | 7              |              | 7  |     |    |           |            |          |              |   |
| 13-4★            | C              | X     | P          | I              | 4              |              |    | 4   |    |           |            |          |              |   |
| 13-8             | C              | X     | P          | I              | 8              |              | 8  |     |    |           |            |          |              |   |
| 13-13■           | C              |       |            | I, Fiber Optic | 4              |              |    | 2** | 2  |           |            |          |              |   |
| 13-35            | C              | X     | P          | M              | 22             | 22           |    |     |    |           |            |          |              |   |
| 13-98            | C              | X     | P          | I              | 10             |              | 10 |     |    |           |            |          |              |   |
| 15-4■            | D              | ◆     |            | I              | 4              |              |    |     | 4  |           |            |          |              |   |
| 15-5★            | D              | X     | P          | II             | 5              |              |    | 5   |    |           |            |          |              |   |
| 15-15            | D              | X     | P          | I              | 15             |              | 14 | 1   |    |           |            |          |              |   |
| 15-18            | D              | X     | P          | I              | 18             |              | 18 |     |    |           |            |          |              |   |
| 15-19            | D              | ◆     | P          | I              | 19             |              | 19 |     |    |           |            |          |              |   |
| 15-35            | D              | X     | P          | M              | 37             | 37           |    |     |    |           |            |          |              |   |
| 15-97            | D              | X     | P          | I              | 12             |              | 8  | 4   |    |           |            |          |              |   |
| 17-2             | E              | X     |            | M              | 39             | 38           |    |     |    |           |            |          |              | 1 |
| 17-6             | E              | X     | P          | I              | 6              |              |    |     | 6  |           |            |          |              |   |
| 17-8★            | E              | X     | P          | II             | 8              |              |    | 8   |    |           |            |          |              |   |
| 17-22★■          | E              | ◆     |            | Coax           | 4              |              |    |     |    | 2         |            | 2        |              |   |
| 17-26            | E              | X     | P          | I              | 26             |              | 26 |     |    |           |            |          |              |   |
| 17-35            | E              | X     | P          | M              | 55             | 55           |    |     |    |           |            |          |              |   |
| 17-99            | E              | X     |            | I              | 23             |              | 21 | 2   |    |           |            |          |              |   |
| 19-11★           | F              | X     | P          | II             | 11             |              |    | 11  |    |           |            |          |              |   |
| 19-18            | F              | X     |            | M              | 18             | 14           |    |     |    |           |            |          |              | 4 |
| 19-28            | F              | X     |            | I              | 28             |              | 26 | 2   |    |           |            |          |              |   |
| 19-31■           | F              | ◆     |            | M              | 15             | 12           |    |     | 1  |           |            | 2        |              |   |
| 19-32            | F              | X     | P          | I              | 32             |              | 32 |     |    |           |            |          |              |   |
| 19-35            | F              | X     | P          | M              | 66             | 66           |    |     |    |           |            |          |              |   |
| 21-11★           | G              | X     |            | I              | 11             |              |    |     | 11 |           |            |          |              |   |
| 21-16★           | G              | X     | P          | II             | 16             |              |    | 16  |    |           |            |          |              |   |
| 21-29■           | G              | X     |            | I              | 27             |              | 19 | 4   | 4  |           |            |          |              |   |
| 21-35            | G              | X     | P          | M              | 79             | 79           |    |     |    |           |            |          |              |   |
| 21-39            | G              | X     | P          | I              | 39             |              | 37 | 2   |    |           |            |          |              |   |
| 21-41            | G              | X     | P          | I              | 41             |              | 41 |     |    |           |            |          |              |   |
| 21-75★◇          | G              | X     |            | M              | 4              |              |    |     |    |           |            | 4        | (See note)   |   |
| 21-79■           | G              | X     |            | II             | 19             | 17           |    |     |    |           |            | 2        |              |   |
| 23-6★■           | H              | P     |            | M              | 6              |              |    |     |    |           |            |          |              | 6 |
| 23-14■           | H              | ◆     |            | I              | 14             |              |    |     | 14 |           |            |          |              |   |
| 23-21★           | H              | X     | P          | II             | 21             |              |    | 21  |    |           |            |          |              |   |

- X Completely tooled.
  - Majority of tooling is completed (contact Amphenol Aerospace for availability).
  - ◆ Not tooled for 02-R.
  - P Pin inserts only (contact Amphenol Aerospace for socket availability).
  - ★ Ground plane proprietary option available. Arrg. 9-5 is exclusively ground plane type. See pg. 49 for further information on ground plane connectors.
  - Not Mil-Qualified.
  - ◇ 21-75 is Mil-Qualified with twinax contacts only.
- Note: MS connector 21-75 is supplied with size 8 twinax.  
Proprietary connector 21-75 is supplied with size 8 coax.

- \* Hermetic inserts - solder termination standard. (Contact Amphenol Aerospace for optional PCB or eyelet termination).
- \*\* Two size 16 contacts dedicated to fiber optics. Consult Amphenol Aerospace catalog 12-352 for fiber optic information.
- \*\*\* For use in MIL-STD-1760 applications (see pages 31 & 32).
- † For RG 180/U and RG 195/U cables only.
- †† Size 8 Coax and Twinax are interchangeable.



# Tri-Start and Specials

## insert availability and identification

### TRI-START ARRANGEMENTS, CONT.

| Shell Size/Arrg. | Military Shell | Crimp | Hermetics* | Service Rating | Total Contacts | Contact Size |    |    |    |           |            |          |              |
|------------------|----------------|-------|------------|----------------|----------------|--------------|----|----|----|-----------|------------|----------|--------------|
|                  |                |       |            |                |                | 22D          | 20 | 16 | 12 | 12 (Coax) | 10 (Power) | 8 (Coax) | 8†† (Twinax) |
| 23-35            | H              | X     | P          | M              | 100            | 100          |    |    |    |           |            |          |              |
| 23-53            | H              | X     | P          | I              | 53             |              | 53 |    |    |           |            |          |              |
| 23-54 ■          | H              | ◆     |            | M              | 53             | 40           |    | 9  | 4  |           |            |          |              |
| 23-55            | H              | ◆     | P          | I              | 55             |              | 55 |    |    |           |            |          |              |
| 25-4             | J              | X     | P          | I              | 56             |              | 48 | 8  |    |           |            |          |              |
| 25-7             | J              | ◆     |            | Twinax         | 99             | 97           |    |    |    |           |            |          | 2            |
| 25-8★            | J              | ◆     |            | Twinax         | 8              |              |    |    |    |           |            |          | 8            |
| 25-11***         | J              | ◆     |            | N              | 11             |              | 2  |    |    |           | 9          |          |              |
| 25-17 ■          | J              | ◆     |            | M              | 42             | 36           |    |    |    |           |            |          | 6            |
| 25-19★           | J              | X     | P          | I              | 19             |              |    |    | 19 |           |            |          |              |
| 25-20***         | J              | ◆     |            | N              | 30             |              | 10 | 13 |    | 4         |            |          | 3            |
| 25-24★           | J              | X     | P          | I              | 24             |              |    | 12 | 12 |           |            |          |              |
| 25-26 ■          | J              | ◆     |            | I              | 25             |              | 16 |    | 5  |           |            | 4        |              |
| 25-29★           | J              | X     |            | I              | 29             |              |    | 29 |    |           |            |          |              |
| 25-35            | J              | X     | P          | M              | 128            | 128          |    |    |    |           |            |          |              |
| 25-37★■          | J              | ◆     |            | I              | 37             |              |    | 37 |    |           |            |          |              |
| 25-41 ■          | J              | X     |            | N/Inst.        | 41             | 22           | 3  | 11 |    | 2         |            |          | 3            |
| 25-43            | J              | ◆     |            | I              | 43             |              | 23 | 20 |    |           |            |          |              |
| 25-46            | J              | ◆     |            | I              | 46             |              | 40 | 4  |    |           |            | 2†       |              |
| 25-61            | J              | X     | P          | I              | 61             |              | 61 |    |    |           |            |          |              |
| 25-90            | J              | X     |            | I              | 46             |              | 40 | 4  |    |           |            |          | 2            |
| 25-F4 ■          | J              | ◆     |            | M/I            | 66             | 49           |    | 13 | 4  |           |            |          |              |

### SPECIAL ARRANGEMENTS (Not Mil-Spec Qualified)

| Shell Size/Arrg. | Military Shell | Crimp | Hermetics* | Service Rating | Total Contacts | Comments         | Contact Size |    |    |    |              |  |  |
|------------------|----------------|-------|------------|----------------|----------------|------------------|--------------|----|----|----|--------------|--|--|
|                  |                |       |            |                |                |                  | 22D          | 20 | 16 | 12 | 8†† (Twinax) |  |  |
| 9-2              | A              | X     |            | I              | 2              | formerly Pyle    |              | 2  |    |    |              |  |  |
| 15-4             | D              | X     |            | II             | 4              | formerly Pyle    |              |    | 4  |    |              |  |  |
| 15-25            | D              | X     |            | M              | 25             | formerly Pyle    | 22           |    | 3  |    |              |  |  |
| 17-20            | E              | X     |            | M              | 20             | formerly Pyle    | 16           |    |    |    | 4            |  |  |
| 21-12            | G              | X     |            | I              | 12             | formerly Pyle    |              | 3  |    |    | 9            |  |  |
| 21-21            | G              | X     |            | M/Inst.        | 41             | improved sealing | 32           |    |    |    | 9            |  |  |
| 21-99            | G              | X     |            | M              | 16             | formerly Pyle    | 5            |    |    |    | 11           |  |  |
| 25-92            | J              | X     |            | M              | 101            | formerly Pyle    | 92           |    |    | 9  |              |  |  |
| 25-97            | J              | X     |            | M              | 42             | formerly Pyle    | 26           |    |    | 3  | 13           |  |  |

### SPECIAL ARRANGEMENTS (Not Mil-Spec Qualified) (insert arrangements requiring non-standard shells or larger contacts)

| Shell Size/Arrg. | Crimp | Hermetics* | Service Rating | Total Contacts | Contact Size |    |   |   |   |
|------------------|-------|------------|----------------|----------------|--------------|----|---|---|---|
|                  |       |            |                |                | 22D          | 20 | 8 | 4 | 0 |
| 25-16            | X     |            | M              | 8              |              | 6  |   | 2 |   |
| 25L-3            | X     |            | II             | 3              |              |    | 1 |   | 2 |
| 25L-7            | X     |            | II             | 7              |              |    | 7 |   |   |
| 33-3             | X     |            | II             | 3              |              |    |   | 1 | 2 |
| 33-5             | X     |            | II             | 5              |              |    |   | 5 |   |
| 33-6             | X     |            | II             | 6              |              |    | 2 |   | 4 |
| 37-5             | X     |            | II             | 4              |              |    |   |   | 4 |

- X Completely tooled.
  - Majority of tooling is completed (contact Amphenol Aerospace for availability).
  - ◆ Not tooled for 02-R.
  - P Pin inserts only (contact Amphenol Aerospace for socket availability).
  - ★ Ground plane proprietary option available. Arrangement 9-5 is exclusively ground plane type.
  - Not Mil-Qualified.
  - \* Hermetic inserts - solder termination standard. (Contact Amphenol Aerospace for optional PCB or eyelet termination).
  - \*\* Two size 16 contacts dedicated to fiber optics. Consult Amphenol Aerospace catalog 12-352 for fiber optic information.
  - \*\*\* For use in MIL-STD-1760 applications (pgs. 31 & 32).
  - † For RG 180/U and RG 195/U cables only.
  - †† Size 8 Coax and Twinax are interchangeable.
- Note: 25L-3 and 25L-7 require longer shells.

# Tri-Start

## alternate positioning

### Master Key/Keyway Position

| Shell Size      | Key & keyway arrangement identification letter | AR° or AP° BSC | BR° or BP° BSC | CR° or CP° BSC | DR° or DP° BSC |
|-----------------|--|----------------|----------------|----------------|----------------|
| 9               | N  | 105            | 140            | 215            | 265            |
|                 | A  | 102            | 132            | 248            | 320            |
|                 | B  | 80             | 118            | 230            | 312            |
|                 | C  | 35             | 140            | 205            | 275            |
|                 | D  | 64             | 155            | 234            | 304            |
| 11, 13, and 15  | N  | 95             | 141            | 208            | 236            |
|                 | A  | 113            | 156            | 182            | 292            |
|                 | B  | 90             | 145            | 195            | 252            |
|                 | C  | 53             | 156            | 220            | 255            |
|                 | D  | 119            | 146            | 176            | 298            |
| 17 and 19       | N  | 80             | 142            | 196            | 293            |
|                 | A  | 135            | 170            | 200            | 310            |
|                 | B  | 49             | 169            | 200            | 244            |
|                 | C  | 66             | 140            | 200            | 257            |
|                 | D  | 62             | 145            | 180            | 280            |
| 21, 23, and 25  | N  | 80             | 142            | 196            | 293            |
|                 | A  | 135            | 170            | 200            | 310            |
|                 | B  | 49             | 169            | 200            | 244            |
|                 | C  | 66             | 140            | 200            | 257            |
|                 | D  | 62             | 145            | 180            | 280            |
| 25L, 33, and 37 | N  | 80             | 142            | 188            | 293            |
|                 | A  | 135            | 170            | 188            | 310            |
|                 | B  | 49             | 169            | 188            | 244            |
|                 | C  | 66             | 140            | 188            | 257            |
|                 | D  | 62             | 145            | 188            | 280            |
|                 | E  | 79             | 153            | 188            | 272            |

A plug with a given rotation letter will mate with a receptacle with the same rotation letter. The angles for a given connector are the same whether it contains pins or sockets. Inserts are not rotated in conjunction with the master key/keyway.



# Tri-Start

## insert arrangements

front face of pin inserts illustrated

|                           |          |      |      |      |      |      |       |       |
|---------------------------|----------|------|------|------|------|------|-------|-------|
|                           |          |      |      |      |      |      |       |       |
| <b>Insert Arrangement</b> | 9-5      | 9-35 | 9-94 | 9-98 | 11-2 | 11-5 | 11-35 | 11-54 |
| <b>Service Rating</b>     | Grounded | M    | M    | I    | I    | I    | M     | II    |
| <b>Number of Contacts</b> | 1        | 6    | 2    | 3    | 2    | 5    | 13    | 4     |
| <b>Contact Size</b>       | 8 Twinax | 22D  | 20   | 20   | 16   | 20   | 22D   | 22D   |

|                           |       |       |      |      |                |       |       |      |
|---------------------------|-------|-------|------|------|----------------|-------|-------|------|
|                           |       |       |      |      |                |       |       |      |
| <b>Insert Arrangement</b> | 11-98 | 11-99 | 13-4 | 13-8 | 13-13          | 13-35 | 13-98 | 15-4 |
| <b>Service Rating</b>     | I     | I     | I    | I    | I, Fiber Optic | M     | I     | I    |
| <b>Number of Contacts</b> | 6     | 7     | 4    | 8    | 2 2            | 22    | 10    | 4    |
| <b>Contact Size</b>       | 20    | 20    | 16   | 20   | 16 12          | 22D   | 20    | 12   |

Dedicated to  
Fiber Optics

|                           |      |       |       |       |       |       |
|---------------------------|------|-------|-------|-------|-------|-------|
|                           |      |       |       |       |       |       |
| <b>Insert Arrangement</b> | 15-5 | 15-15 | 15-18 | 15-19 | 15-35 | 15-97 |
| <b>Service Rating</b>     | II   | I     | I     | I     | M     | I     |
| <b>Number of Contacts</b> | 5    | 14 1  | 18    | 19    | 37    | 8 4   |
| <b>Contact Size</b>       | 16   | 20 16 | 20    | 20    | 22D   | 20 16 |

|                           |              |      |      |                |       |
|---------------------------|--------------|------|------|----------------|-------|
|                           |              |      |      |                |       |
| <b>Insert Arrangement</b> | 17-2         | 17-6 | 17-8 | 17-22          | 17-26 |
| <b>Service Rating</b>     | M            | I    | II   | Coax           | I     |
| <b>Number of Contacts</b> | 38 1         | 6    | 8    | 2 2            | 26    |
| <b>Contact Size</b>       | 22D 8 Twinax | 12   | 16   | 12 Coax 8 Coax | 20    |



# Tri-Start

## insert arrangements

front face of pin inserts illustrated



**17-35**

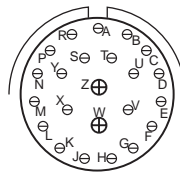

**17-99**

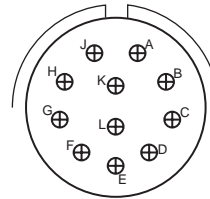

**19-11**

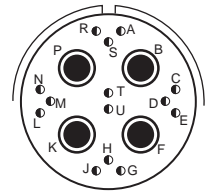

**19-18**

**Insert Arrangement**  
**Service Rating**  
**Number of Contacts**  
**Contact Size**

**M**  
**55**  
**22D**

**I**  
**21 2**  
**20 16**

**II**  
**11**  
**16**

**M**  
**14 4**  
**22D 8 Twinax**

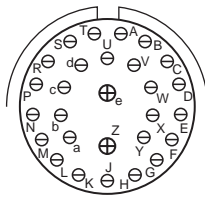

**19-28**

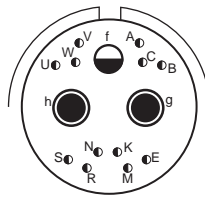

**19-31**

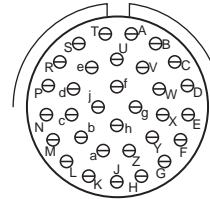

**19-32**

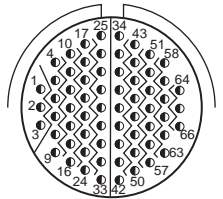

**19-35**

**Insert Arrangement**  
**Service Rating**  
**Number of Contacts**  
**Contact Size**

**I**  
**26 2**  
**20 16**

**M**  
**2 1 12**  
**8 Coax 12 22D**

**I**  
**32**  
**20**

**M**  
**66**  
**22D**

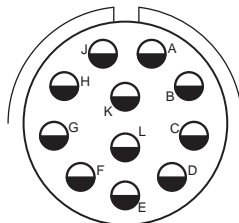

**21-11**

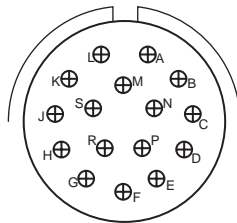

**21-16**

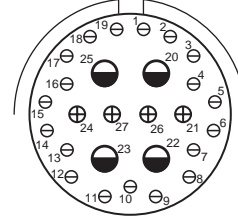

**21-29**

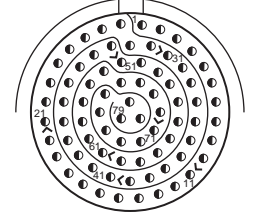

**21-35**

**Insert Arrangement**  
**Service Rating**  
**Number of Contacts**  
**Contact Size**

**I**  
**11**  
**12**

**II**  
**16**  
**16**

**I**  
**19 4 4**  
**20 16 12**

**M**  
**79**  
**22D**



**CONTACT LEGEND**

**8 10 12 16 20 22D**

# Tri-Start

## insert arrangements

front face of pin inserts illustrated



|                           |              |           |              |  |                 |  |              |               |
|---------------------------|--------------|-----------|--------------|--|-----------------|--|--------------|---------------|
| <b>Insert Arrangement</b> | <b>21-39</b> |           | <b>21-41</b> |  | <b>21-75</b>    |  | <b>21-79</b> |               |
| <b>Service Rating</b>     | <b>I</b>     |           | <b>I</b>     |  | <b>M</b>        |  | <b>II</b>    |               |
| <b>Number of Contacts</b> | <b>37</b>    | <b>2</b>  | <b>41</b>    |  | <b>4</b>        |  | <b>17</b>    | <b>2</b>      |
| <b>Contact Size</b>       | <b>20</b>    | <b>16</b> | <b>20</b>    |  | <b>8 Twinax</b> |  | <b>22D</b>   | <b>8 Coax</b> |



|                           |                 |  |              |  |              |  |              |  |
|---------------------------|-----------------|--|--------------|--|--------------|--|--------------|--|
| <b>Insert Arrangement</b> | <b>23-6</b>     |  | <b>23-14</b> |  | <b>23-21</b> |  | <b>23-35</b> |  |
| <b>Service Rating</b>     | <b>M</b>        |  | <b>I</b>     |  | <b>II</b>    |  | <b>M</b>     |  |
| <b>Number of Contacts</b> | <b>6</b>        |  | <b>14</b>    |  | <b>21</b>    |  | <b>100</b>   |  |
| <b>Contact Size</b>       | <b>8 Twinax</b> |  | <b>12</b>    |  | <b>16</b>    |  | <b>22D</b>   |  |

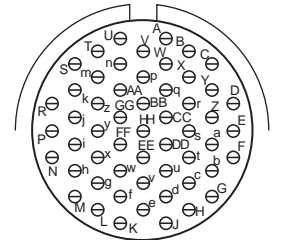
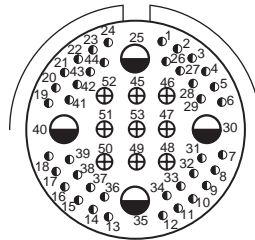
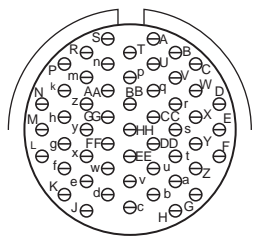

|                           |              |  |              |           |              |           |
|---------------------------|--------------|--|--------------|-----------|--------------|-----------|
| <b>Insert Arrangement</b> | <b>23-53</b> |  | <b>23-54</b> |           | <b>23-55</b> |           |
| <b>Service Rating</b>     | <b>I</b>     |  | <b>M</b>     |           | <b>I</b>     |           |
| <b>Number of Contacts</b> | <b>53</b>    |  | <b>40</b>    | <b>9</b>  | <b>4</b>     | <b>55</b> |
| <b>Contact Size</b>       | <b>20</b>    |  | <b>22D</b>   | <b>16</b> | <b>12</b>    | <b>20</b> |



# Tri-Start insert arrangements

front face of pin inserts illustrated



|                    |      |    |        |          |          |  |
|--------------------|------|----|--------|----------|----------|--|
| Insert Arrangement | 25-4 |    | 25-7   |          | 25-8     |  |
| Service Rating     | I    |    | Twinax |          | Twinax   |  |
| Number of Contacts | 48   | 8  | 97     | 2        | 8        |  |
| Contact Size       | 20   | 16 | 22D    | 8 Twinax | 8 Twinax |  |



|                    |          |          |       |          |       |  |
|--------------------|----------|----------|-------|----------|-------|--|
| Insert Arrangement | 25-11*** |          | 25-17 |          | 25-19 |  |
| Service Rating     | N        |          | M     |          | I     |  |
| Number of Contacts | 2        | 9        | 36    | 6        | 19    |  |
| Contact Size       | 20       | 10 Power | 22D   | 8 Twinax | 12    |  |



|                    |          |    |          |         |       |    |       |    |        |
|--------------------|----------|----|----------|---------|-------|----|-------|----|--------|
| Insert Arrangement | 25-20*** |    |          |         | 25-24 |    | 25-26 |    |        |
| Service Rating     | N        |    |          |         | I     |    | I     |    |        |
| Number of Contacts | 10       | 13 | 3        | 4       | 12    | 12 | 16    | 5  | 4      |
| Contact Size       | 20       | 16 | 8 Twinax | 12 Coax | 16    | 12 | 20    | 12 | 8 Coax |

(With Matched Impedance)

\*\*\* For use in MIL-STD-1760 applications (see pages 31 and 32).



# Tri-Start insert arrangements

front face of pin inserts illustrated



**Insert Arrangement**  
**Service Rating**  
**Number of Contacts**  
**Contact Size**

**25-29**  
**I**  
**29**  
**16**

**25-35**  
**M**  
**128**  
**22D**

**25-37**  
**I**  
**37**  
**16**



**Insert Arrangement**  
**Service Rating**  
**Number of Contacts**  
**Contact Size**

**25-41**  
**N/Inst.**  
**22**   **3**   **11**   **2**   **3**  
**22D**   **20**   **16**   **12 Coax**   **8 Twinax**

**25-43**  
**I**  
**23**   **20**  
**20**   **16**

**25-46**  
**I**  
**40**   **4**   **2**  
**20**   **16**   **8 Coax†**



**Insert Arrangement**  
**Service Rating**  
**Number of Contacts**  
**Contact Size**

**25-61**  
**I**  
**61**  
**20**

**25-90**  
**I**  
**40**   **4**   **2**  
**20**   **16**   **8 Twinax**

**25-F4**  
**Size 22D = M, Balance = I**  
**49**   **13**   **4**  
**22D**   **16**   **12**

† Coax contacts for RG180/U or RG195/U cable.



# Special insert arrangements

front face of pin inserts illustrated

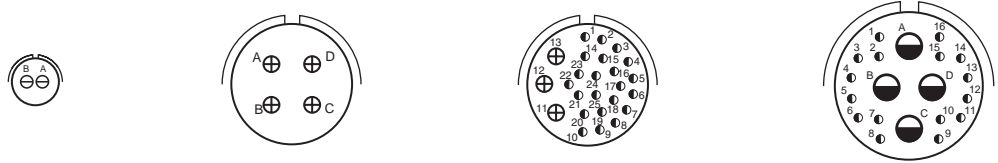

|                           |            |              |               |               |
|---------------------------|------------|--------------|---------------|---------------|
| <b>Insert Arrangement</b> | <b>9-2</b> | <b>15-4*</b> | <b>15-25</b>  | <b>17-20</b>  |
| <b>Service Rating</b>     | <b>I</b>   | <b>II</b>    | <b>M</b>      | <b>M</b>      |
| <b>Number of Contacts</b> | <b>2</b>   | <b>4</b>     | <b>22 3</b>   | <b>16 4</b>   |
| <b>Contact Size</b>       | <b>20</b>  | <b>16</b>    | <b>22D 16</b> | <b>22D 12</b> |

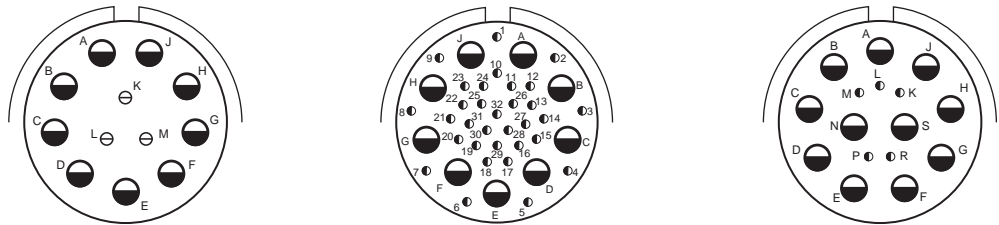

|                           |              |                |               |
|---------------------------|--------------|----------------|---------------|
| <b>Insert Arrangement</b> | <b>21-12</b> | <b>21-21</b>   | <b>21-99</b>  |
| <b>Service Rating</b>     | <b>I</b>     | <b>M/Inst.</b> | <b>M</b>      |
| <b>Number of Contacts</b> | <b>3 9</b>   | <b>32 9</b>    | <b>5 11</b>   |
| <b>Contact Size</b>       | <b>20 12</b> | <b>22D 12</b>  | <b>22D 12</b> |



|                           |               |                  |
|---------------------------|---------------|------------------|
| <b>Insert Arrangement</b> | <b>25-92</b>  | <b>25-97</b>     |
| <b>Service Rating</b>     | <b>M</b>      | <b>M</b>         |
| <b>Number of Contacts</b> | <b>92 9</b>   | <b>26 3 13</b>   |
| <b>Contact Size</b>       | <b>22D 16</b> | <b>22D 16 12</b> |

NOTE: Some specials shown here were formerly known as Pyle arrangements. Consult Amphenol for how to order information for connectors with these inserts.

For further information on special arrangements consult Amphenol Aerospace, Sidney NY.

\* Pyle 15-4 does not mate with Amphenol Tri-Start 15-4 insert.





# Special

## insert arrangements requiring non-standard shells or larger contacts

front face of pin inserts illustrated



Insert Arrangement  
Service Rating  
Number of Contacts  
Contact Size

**25-16**  
**M**  
**6 2**  
**20 4**

**25L-3**  
**II**  
**1 2**  
**8 4**

**25L-7**  
**II**  
**7**  
**8**

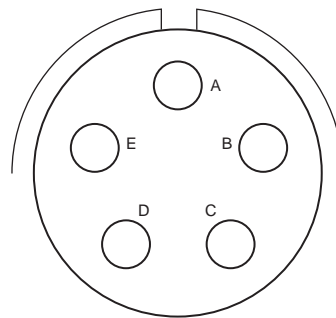

Insert Arrangement  
Service Rating  
Number of Contacts  
Contact Size

**33-3**  
**II**  
**1 2**  
**4 0**

**33-5**  
**II**  
**5**  
**4**

**33-6**  
**II**  
**2 4**  
**8 4**



Insert Arrangement  
Service Rating  
Number of Contacts  
Contact Size

**37-5**  
**II**  
**4**  
**0**

NOTE: Some specials shown here were formerly known as Pyle arrangements. Consult Amphenol for how to order information for connectors with these inserts.

Consult Amphenol Aerospace for longer shell drawings.

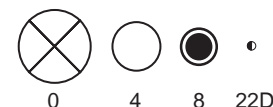

# TVP00R (D38999/20) – crimp, metal CTVP00R (D38999/20) – crimp, composite wall mounting receptacle

Part number reference.  
See how to order, pages 43-46  
to complete.  
TVP00RW-XX-XXX  
TVPS00RK-XX-XXX  
TVPS00RF-XX-XXX  
TVPS00RS-XX-XXX  
CTVP00RW-XX-XXX  
CTVPS00RF-XX-XXX  
D38999/20



VIEW D  
FOR SIZE 8 COAXIAL ONLY,  
RELATIVE TO -A-



VIEW D  
FOR SIZE 8 TWINAX ONLY,  
RELATIVE TO -A-



PANEL HOLE  
DIMENSIONS



BACK PANEL  
MOUNTING



FRONT PANEL  
MOUNTING

† Red band indicates fully mated  
†† Blue band indicates rear release contact retention system

Inches

| Shell Size | MS Shell Size Code | B Thread Class 2A 0.1P-0.3L-TS (Plated) | L Max. (TV) | L <sup>1</sup> Max. (CTV) | M +.000 (TV) | M <sup>1</sup> +.000 - .005 (CTV) | R <sup>1</sup> | R <sup>2</sup> | S Max. | T ±.008 | Z Max. (TV) | Z <sup>1</sup> Max. (CTV) | A <sup>1</sup> Dia. Back Panel Mount | A <sup>2</sup> Dia. Front Panel Mount | AA Max. Panel Thickness | LL +.006 - .000 (TV) | LL <sup>1</sup> ±.005 (CTV) | TT ±.008 |
|------------|--------------------|---|-------------|---------------------------|--------------|-----------------------------------|----------------|----------------|--------|---------|-------------|---------------------------|--------------------------------------|---------------------------------------|-------------------------|----------------------|-----------------------------|----------|
| 9          | A                  | .6250                                   | .469        | .514                      | .820         | .773                              | .719           | .594           | .948   | .128    | .153        | .198                      | .650                                 | .510                                  | .234                    | .905                 | .908                        | .216     |
| 11         | B                  | .7500                                   | .469        | .514                      | .820         | .773                              | .812           | .719           | 1.043  | .128    | .153        | .198                      | .800                                 | .620                                  | .234                    | .905                 | .908                        | .194     |
| 13         | C                  | .8750                                   | .469        | .514                      | .820         | .773                              | .906           | .812           | 1.137  | .128    | .153        | .198                      | .910                                 | .740                                  | .234                    | .905                 | .908                        | .194     |
| 15         | D                  | 1.0000                                  | .469        | .514                      | .820         | .773                              | .969           | .906           | 1.232  | .128    | .153        | .198                      | 1.040                                | .900                                  | .234                    | .905                 | .908                        | .173     |
| 17         | E                  | 1.1875                                  | .469        | .514                      | .820         | .773                              | 1.062          | .969           | 1.323  | .128    | .153        | .198                      | 1.210                                | 1.010                                 | .234                    | .905                 | .908                        | .194     |
| 19         | F                  | 1.2500                                  | .469        | .514                      | .820         | .773                              | 1.156          | 1.062          | 1.449  | .128    | .153        | .198                      | 1.280                                | 1.130                                 | .234                    | .905                 | .908                        | .194     |
| 21         | G                  | 1.3750                                  | .500        | .545                      | .790         | .741                              | 1.250          | 1.156          | 1.575  | .128    | .183        | .228                      | 1.410                                | 1.250                                 | .204                    | .905                 | .904                        | .194     |
| 23         | H                  | 1.5000                                  | .500        | .545                      | .790         | .741                              | 1.375          | 1.250          | 1.701  | .154    | .183        | .228                      | 1.530                                | 1.360                                 | .204                    | .905                 | .904                        | .242     |
| 25         | J                  | 1.6250                                  | .500        | .545                      | .790         | .741                              | 1.500          | 1.375          | 1.823  | .154    | .183        | .228                      | 1.660                                | 1.470                                 | .204                    | .905                 | .904                        | .242     |

Millimeters

| Shell Size | MS Shell Size Code | L Max. (TV) | L <sup>1</sup> Max. (CTV) | M +.00 - .13 (TV) | M <sup>1</sup> +.00 - .13 (CTV) | R <sup>1</sup> | R <sup>2</sup> | S Max | T ±.20 | V Thread Metric | Z Max. (TV) | Z <sup>1</sup> Max. (CTV) | A <sup>1</sup> Dia. Back Panel Mount | A <sup>2</sup> Dia. Front Panel Mount | AA Max. | LL +.15 - .00 (TV) | LL <sup>1</sup> ±.13 (CTV) | TT ±.20 |
|------------|--------------------|-------------|---------------------------|-------------------|---------------------------------|----------------|----------------|-------|--------|-----------------|-------------|---------------------------|--------------------------------------|---------------------------------------|---------|--------------------|----------------------------|---------|
| 9          | A                  | 11.91       | 13.06                     | 20.83             | 19.63                           | 18.26          | 15.09          | 24.1  | 3.25   | M12X1-6g        | 3.89        | 5.03                      | 16.66                                | 13.11                                 | 5.94    | 22.99              | 23.06                      | 5.49    |
| 11         | B                  | 11.91       | 13.06                     | 20.83             | 19.63                           | 20.62          | 18.26          | 26.5  | 3.25   | M15X1-6g        | 3.89        | 5.03                      | 20.22                                | 15.88                                 | 5.94    | 22.99              | 23.06                      | 4.93    |
| 13         | C                  | 11.91       | 13.06                     | 20.83             | 19.63                           | 23.01          | 20.62          | 28.9  | 3.25   | M18X1-6g        | 3.89        | 5.03                      | 23.42                                | 19.05                                 | 5.94    | 22.99              | 23.06                      | 4.93    |
| 15         | D                  | 11.91       | 13.06                     | 20.83             | 19.63                           | 24.61          | 23.01          | 31.3  | 3.25   | M22X1-6g        | 3.89        | 5.03                      | 26.59                                | 23.01                                 | 5.94    | 22.99              | 23.06                      | 4.39    |
| 17         | E                  | 11.91       | 13.06                     | 20.83             | 19.63                           | 26.97          | 24.61          | 33.7  | 3.25   | M25X1-6g        | 3.89        | 5.03                      | 30.96                                | 25.81                                 | 5.94    | 22.99              | 23.06                      | 4.93    |
| 19         | F                  | 11.91       | 13.06                     | 20.83             | 19.63                           | 29.36          | 26.97          | 36.9  | 3.25   | M28X1-6g        | 3.89        | 5.03                      | 32.94                                | 28.98                                 | 5.94    | 22.99              | 23.06                      | 4.93    |
| 21         | G                  | 12.70       | 13.84                     | 20.07             | 18.82                           | 31.75          | 29.36          | 40.1  | 3.25   | M31X1-6g        | 4.65        | 5.79                      | 36.12                                | 32.16                                 | 5.18    | 22.99              | 22.96                      | 4.93    |
| 23         | H                  | 12.70       | 13.84                     | 20.07             | 18.82                           | 34.93          | 31.75          | 43.3  | 3.91   | M34X1-6g        | 4.65        | 5.79                      | 39.29                                | 34.93                                 | 5.18    | 22.99              | 22.96                      | 6.15    |
| 25         | J                  | 12.70       | 13.84                     | 20.07             | 18.82                           | 38.10          | 34.93          | 46.4  | 3.91   | M37X1-6g        | 4.65        | 5.79                      | 42.47                                | 37.69                                 | 5.18    | 22.99              | 22.96                      | 6.15    |

All dimensions for reference only

□ Designates true position dimensioning

# TVP02R – crimp, metal CTVP02R – crimp, composite box mounting receptacle

Part number reference.  
See how to order, pages 43-46 to complete.  
TVP02RW-XX-XXX  
TVPS02RK-XX-XXX  
TVPS02RF-XX-XXX  
TVPS02RS-XX-XXX  
CTVP02RW-XX-XXX  
CTVPS02RF-XX-XXX



† Red band indicates fully mated  
†† Blue band indicates rear release contact retention system  
Consult Amphenol Aerospace for availability of composite box mount receptacles.

Inches

| Shell Size | MS Shell Size Code | B Thread Class 2A 0.1P-0.3L-TS (Plated) | L Max. (TV) | L <sup>1</sup> Max. (CTV) | M +.000 - .005 (TV) | M <sup>1</sup> +.000 - .005 (CTV) | R <sup>1</sup> | R <sup>2</sup> | S Max. | T ±.008 | Z Max. (TV) | Z <sup>1</sup> Max. (CTV) | A <sup>1</sup> Back Panel Mount | A <sup>2</sup> Front Panel Mount | AA Max. Panel Thickness | LL +.006 - .000 (TV) | LL <sup>1</sup> ±.005 (CTV) | TT ±.008 |
|------------|--------------------|---|-------------|---------------------------|---------------------|-----------------------------------|----------------|----------------|--------|---------|-------------|---------------------------|---------------------------------|----------------------------------|-------------------------|----------------------|-----------------------------|----------|
| 9          | A                  | .6250                                   | .205        | .250                      | .820                | .773                              | .719           | .594           | .948   | .128    | .153        | .198                      | .650                            | .510                             | .234                    | .905                 | .908                        | .216     |
| 11         | B                  | .7500                                   | .205        | .250                      | .820                | .773                              | .812           | .719           | 1.043  | .128    | .153        | .198                      | .800                            | .620                             | .234                    | .905                 | .908                        | .194     |
| 13         | C                  | .8750                                   | .205        | .250                      | .820                | .773                              | .906           | .812           | 1.137  | .128    | .153        | .198                      | .910                            | .740                             | .234                    | .905                 | .908                        | .194     |
| 15         | D                  | 1.0000                                  | .205        | .250                      | .820                | .773                              | .969           | .906           | 1.232  | .128    | .153        | .198                      | 1.040                           | .900                             | .234                    | .905                 | .908                        | .173     |
| 17         | E                  | 1.1875                                  | .205        | .250                      | .820                | .773                              | 1.062          | .969           | 1.323  | .128    | .153        | .198                      | 1.210                           | 1.010                            | .234                    | .905                 | .908                        | .194     |
| 19         | F                  | 1.2500                                  | .205        | .250                      | .820                | .773                              | 1.156          | 1.062          | 1.449  | .128    | .153        | .198                      | 1.280                           | 1.130                            | .234                    | .905                 | .908                        | .194     |
| 21         | G                  | 1.3750                                  | .235        | .280                      | .790                | .741                              | 1.250          | 1.156          | 1.575  | .128    | .183        | .228                      | 1.410                           | 1.250                            | .204                    | .905                 | .904                        | .194     |
| 23         | H                  | 1.5000                                  | .235        | .280                      | .790                | .741                              | 1.375          | 1.250          | 1.701  | .154    | .183        | .228                      | 1.530                           | 1.360                            | .204                    | .905                 | .904                        | .242     |
| 25         | J                  | 1.6250                                  | .235        | .280                      | .790                | .741                              | 1.500          | 1.375          | 1.823  | .154    | .183        | .228                      | 1.660                           | 1.470                            | .204                    | .905                 | .904                        | .242     |

Millimeters

| Shell Size | MS Shell Size Code | L Max. (TV) | L <sup>1</sup> Max. (CTV) | M +.00 - .13 (TV) | M <sup>1</sup> +.00 - .13 (CTV) | R <sup>1</sup> | R <sup>2</sup> | S Max. | T ±.20 | Z Max. (TV) | Z <sup>1</sup> Max. (CTV) | A <sup>1</sup> Back Panel Mount | A <sup>2</sup> Front Panel Mount | AA Max. | LL +.15 - .00 (TV) | LL <sup>1</sup> ±.13 (CTV) | TT ±.20 |
|------------|--------------------|-------------|---------------------------|-------------------|---------------------------------|----------------|----------------|--------|--------|-------------|---------------------------|---------------------------------|----------------------------------|---------|--------------------|----------------------------|---------|
| 9          | A                  | 5.21        | 6.35                      | 20.83             | 19.63                           | 18.26          | 15.09          | 24.1   | 3.25   | 3.89        | 5.03                      | 16.66                           | 13.11                            | 5.94    | 22.99              | 23.06                      | 5.49    |
| 11         | B                  | 5.21        | 6.35                      | 20.83             | 19.63                           | 20.62          | 18.26          | 26.5   | 3.25   | 3.89        | 5.03                      | 20.22                           | 15.88                            | 5.94    | 22.99              | 23.06                      | 4.93    |
| 13         | C                  | 5.21        | 6.35                      | 20.83             | 19.63                           | 23.01          | 20.62          | 28.9   | 3.25   | 3.89        | 5.03                      | 23.42                           | 19.05                            | 5.94    | 22.99              | 23.06                      | 4.93    |
| 15         | D                  | 5.21        | 6.35                      | 20.83             | 19.63                           | 24.61          | 23.01          | 31.3   | 3.25   | 3.89        | 5.03                      | 26.59                           | 23.01                            | 5.94    | 22.99              | 23.06                      | 4.39    |
| 17         | E                  | 5.21        | 6.35                      | 20.83             | 19.63                           | 26.97          | 24.61          | 33.7   | 3.25   | 3.89        | 5.03                      | 30.96                           | 25.81                            | 5.94    | 22.99              | 23.06                      | 4.93    |
| 19         | F                  | 5.21        | 6.35                      | 20.83             | 19.63                           | 29.36          | 26.97          | 36.9   | 3.25   | 3.89        | 5.03                      | 32.94                           | 28.98                            | 5.94    | 22.99              | 23.06                      | 4.93    |
| 21         | G                  | 5.97        | 7.11                      | 20.07             | 18.82                           | 31.75          | 29.36          | 40.1   | 3.25   | 4.65        | 5.79                      | 36.12                           | 32.16                            | 5.18    | 22.99              | 22.96                      | 4.93    |
| 23         | H                  | 5.97        | 7.11                      | 20.07             | 18.82                           | 34.92          | 31.75          | 43.3   | 3.91   | 4.65        | 5.79                      | 39.29                           | 34.93                            | 5.18    | 22.99              | 22.96                      | 6.15    |
| 25         | J                  | 5.97        | 7.11                      | 20.07             | 18.82                           | 38.10          | 34.92          | 46.4   | 3.91   | 4.65        | 5.79                      | 42.47                           | 37.69                            | 5.18    | 22.99              | 22.96                      | 6.15    |

All dimensions for reference only

Designates true position dimensioning

# TV06R (D38999/26) – crimp, metal CTV06R (D38999/26) – crimp, composite straight plug

Part number reference.  
See how to order, pages 43-46  
to complete.  
TV06RW-XX-XXX  
TVS06RK-XX-XXX  
TVS06RF-XX-XXX  
TVS06RS-XX-XXX  
CTV06RW-XX-XXX  
CTVS06RF-XX-XXX  
D38999/26

## METAL



VIEW D  
FOR SIZE 8 COAXIAL ONLY,  
RELATIVE TO  $\square$ -A-

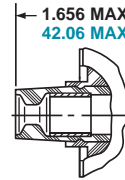

VIEW D  
FOR SIZE 8 TWINAX ONLY,  
RELATIVE TO  $\square$ -A-

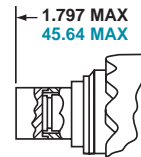

## COMPOSITE

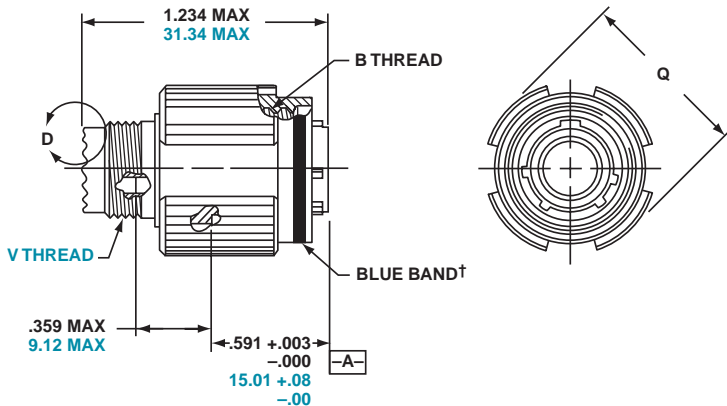

† Blue band indicates rear release contact retention system

Inches

| Shell Size | MS Shell Size Code | B Thread 0.1P-0.3L-TS-2B (Plated) | Q Dia. Max. |
|------------|--------------------|-----------------------------------|-------------|
| 9          | A                  | .6250                             | .858        |
| 11         | B                  | .7500                             | .984        |
| 13         | C                  | .8750                             | 1.157       |
| 15         | D                  | 1.0000                            | 1.280       |
| 17         | E                  | 1.1875                            | 1.406       |
| 19         | F                  | 1.2500                            | 1.516       |
| 21         | G                  | 1.3750                            | 1.642       |
| 23         | H                  | 1.5000                            | 1.768       |
| 25         | J                  | 1.6250                            | 1.890       |

Millimeters

| Shell Size | MS Shell Size Code | Q Max. | V Thread Metric |
|------------|--------------------|--------|-----------------|
| 9          | A                  | 21.8   | M12X1-6g        |
| 11         | B                  | 25.0   | M15X1-6g        |
| 13         | C                  | 29.4   | M18X1-6g        |
| 15         | D                  | 32.5   | M22X1-6g        |
| 17         | E                  | 35.7   | M25X1-6g        |
| 19         | F                  | 38.5   | M28X1-6g        |
| 21         | G                  | 41.7   | M31X1-6g        |
| 23         | H                  | 44.9   | M34X1-6g        |
| 25         | J                  | 48.0   | M37X1-6g        |

All dimensions for reference only.

# TV26/MTV26 – crimp, metal CLUTCH-LOK<sup>®</sup> straight plug for high vibration and harsh environment applications

Part number reference.  
See how to order, pages 43, 44  
to complete.

TV26RKXXXXX  
TV26RSXXXXX

For parts with MS Stamping  
use MTV26( ) part number as  
follow:

MTV26RKXXXXX  
MTV26RSXXXXX

The latest in MIL-DTL-38999, Series III Connector Technology is the CLUTCH-LOK. Designed for high vibration and harsh environments such as aircraft gas turbine engines, it is also an ideal choice for demanding applications such as aircraft, space and military ground vehicles. The unique clutch design of the Amphenol CLUTCH-LOK means that you don't have to compromise the need for quick, smooth mating of plugs and receptacles in order to get increased uncoupling torque.

The CLUTCH-LOK has proven to not only remain mated and pass all the Series III specification requirements - it also has proven to actually tighten itself under vibration. This is a powerful advantage over the traditionally high vibration application connectors. The CLUTCH-LOK is also a tremendous advantage in inaccessible, hard to reach areas where mating torque is difficult to apply and complete coupling is not verifiable by inspection.

CLUTCH-LOK features and benefits:

- High degree of differential torque
- Infinite free coupling and positive metal-to-metal bottoming with each mating
- No settling back to the next ratchet tooth
- Available with stainless steel shells and Class K firewall inserts
- All the advantages of MIL-DTL-38999 Series III including EMI/RFI shielding, electrolytic erosion resistance and contact protection with recessed pins
- Enhanced connector performance at affordable prices
- Completely intermateable with all existing MIL-DTL-38999 Series III connectors
- Fully QPL'd

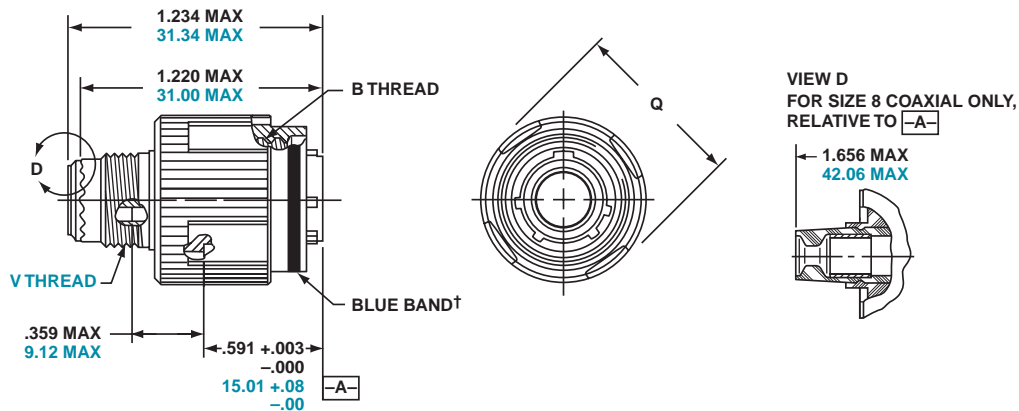

† Blue band indicates rear release contact retention system

Inches

| Shell Size | MS Shell Size Code | B Thread<br>0.1P-0.3L-TS-2B<br>(Plated) | Q<br>Dia.<br>Max. |
|------------|--------------------|---|-------------------|
| 9          | A                  | .6250                                   | .858              |
| 11         | B                  | .7500                                   | .984              |
| 13         | C                  | .8750                                   | 1.157             |
| 15         | D                  | 1.0000                                  | 1.280             |
| 17         | E                  | 1.1875                                  | 1.406             |
| 19         | F                  | 1.2500                                  | 1.516             |
| 21         | G                  | 1.3750                                  | 1.642             |
| 23         | H                  | 1.5000                                  | 1.768             |
| 25         | J                  | 1.6250                                  | 1.890             |

Millimeters

| Shell Size | MS Shell Size Code | Q<br>Max. | V<br>Thread<br>Metric |
|------------|--------------------|-----------|-----------------------|
| 9          | A                  | 21.8      | M12X1-6g              |
| 11         | B                  | 25.0      | M15X1-6g              |
| 13         | C                  | 29.4      | M18X1-6g              |
| 15         | D                  | 32.5      | M22X1-6g              |
| 17         | E                  | 35.7      | M25X1-6g              |
| 19         | F                  | 38.5      | M28X1-6g              |
| 21         | G                  | 41.7      | M31X1-6g              |
| 23         | H                  | 44.9      | M34X1-6g              |
| 25         | J                  | 48.0      | M37X1-6g              |

All dimensions for reference only.

# TV07R (D38999/24) – crimp, metal CTV07R (D38999/24) – crimp, composite jam nut receptacle

Part number reference.  
See how to order, pages 43-46  
to complete.  
TV07RW-XX-XXX  
TVS07RK-XX-XXX  
TVS07RF-XX-XXX  
TVS07RS-XX-XXX  
CTV07RW-XX-XXX  
CTVS07RF-XX-XXX  
D38999/24



† Red band indicates fully mated  
†† Blue band indicates rear release contact retention system  
★ .059 dia min.  
1.5 dia min. 3 lockwire holes  
Formed lockwire hole design (6 holes) is optional

Inches

| Shell Size | MS Shell Size Code | A*<br>+.000<br>-.010 | B Thread Class 2A<br>0.1P-0.3L-TS<br>(Plated) | C<br>Max. | D <sup>1</sup><br>+.010<br>-.000 | D <sup>2</sup><br>+.000<br>-.010 | H Hex<br>+.017<br>-.016 | S<br>±.010 | T*<br>+.010<br>-.000 |
|------------|--------------------|----------------------|---|-----------|----------------------------------|----------------------------------|-------------------------|------------|----------------------|
| 9          | A                  | .669                 | .6250   | 1.199     | .700                             | .670                             | .875                    | 1.062      | .697                 |
| 11         | B                  | .769                 | .7500   | 1.386     | .825                             | .770                             | 1.000                   | 1.250      | .822                 |
| 13         | C                  | .955                 | .8750   | 1.511     | 1.010                            | .955                             | 1.188                   | 1.375      | 1.007                |
| 15         | D                  | 1.084                | 1.0000  | 1.636     | 1.135                            | 1.085                            | 1.312                   | 1.500      | 1.134                |
| 17         | E                  | 1.208                | 1.1875  | 1.761     | 1.260                            | 1.210                            | 1.438                   | 1.625      | 1.259                |
| 19         | F                  | 1.333                | 1.2500  | 1.949     | 1.385                            | 1.335                            | 1.562                   | 1.812      | 1.384                |
| 21         | G                  | 1.459                | 1.3750  | 2.073     | 1.510                            | 1.460                            | 1.688                   | 1.938      | 1.507                |
| 23         | H                  | 1.575                | 1.5000  | 2.199     | 1.635                            | 1.585                            | 1.812                   | 2.062      | 1.634                |
| 25         | J                  | 1.709                | 1.6250  | 2.323     | 1.760                            | 1.710                            | 2.000                   | 2.188      | 1.759                |

Millimeters

| Shell Size | MS Shell Size Code | A*<br>+.00<br>-.25 | C<br>Max. | D <sup>1</sup><br>+.25<br>-.00 | D <sup>2</sup><br>+.00<br>-.25 | H Hex<br>+.43<br>-.41 | S<br>±.25 | T*<br>+.25<br>-.00 | V Thread Metric |
|------------|--------------------|--------------------|-----------|--------------------------------|--------------------------------|-----------------------|-----------|--------------------|-----------------|
| 9          | A                  | 16.99              | 30.45     | 17.78                          | 17.02                          | 22.23                 | 26.97     | 17.70              | M12X1-6g        |
| 11         | B                  | 19.53              | 35.20     | 20.96                          | 19.59                          | 25.40                 | 31.75     | 20.88              | M15X1-6g        |
| 13         | C                  | 24.26              | 38.38     | 25.65                          | 24.26                          | 30.18                 | 34.93     | 25.58              | M18X1-6g        |
| 15         | D                  | 27.53              | 41.55     | 28.83                          | 27.56                          | 33.32                 | 38.10     | 28.80              | M22X1-6g        |
| 17         | E                  | 30.68              | 44.73     | 32.01                          | 30.73                          | 36.53                 | 41.28     | 31.98              | M25X1-6g        |
| 19         | F                  | 33.86              | 49.50     | 35.18                          | 33.91                          | 39.67                 | 46.02     | 35.15              | M28X1-6g        |
| 21         | G                  | 37.06              | 52.65     | 38.35                          | 37.08                          | 42.80                 | 49.23     | 38.28              | M31X1-6g        |
| 23         | H                  | 40.01              | 55.85     | 41.53                          | 40.26                          | 46.02                 | 52.37     | 41.50              | M34X1-6g        |
| 25         | J                  | 43.41              | 59.00     | 44.70                          | 43.43                          | 50.80                 | 55.58     | 44.68              | M37X1-6g        |

All dimensions for reference only  
NOTE: Deep reach receptacles are available for panel thicknesses up to .750 max.  
• D shaped panel cut-out dimensions

# TV01R – crimp, metal CTV01R – crimp, composite line receptacle

Part number reference.  
See how to order, 43-45 to  
complete.

TV01RW-XX-XXX  
TVS01RF-XX-XXX  
CTV01RW-XX-XXX  
CTVS01RF-XX-XXX



† Red band indicates fully mated

†† Blue band indicates rear release contact retention system

Inches

| Shell Size | MS Shell Size Code | B Thread<br>0.1P-0.3L-TS-2A<br>(Plated) | M<br>+.000<br>-.005<br>(TV) | M'<br>+.000<br>-.005<br>(CTV) | L<br>Max.<br>(TV) | L'<br>Max.<br>(CTV) | S<br>±.010<br>(TV) | S'<br>±.010<br>(CTV) | Z<br>Max.<br>(TV) | Z'<br>Max.<br>(CTV) | GG<br>±.010<br>(TV) | GG'<br>±.010<br>(CTV) | LL<br>+.006<br>-.000<br>(TV) | LL'<br>±.005<br>(CTV) |
|------------|--------------------|---|-----------------------------|-------------------------------|-------------------|---------------------|--------------------|----------------------|-------------------|---------------------|---------------------|-----------------------|------------------------------|-----------------------|
| 9          | A                  | .6250                                   | .820                        | .773                          | .469              | .514                | .675               | .635                 | .153              | .198                | .812                | .699                  | .905                         | .908                  |
| 11         | B                  | .7500                                   | .820                        | .773                          | .469              | .514                | .800               | .765                 | .153              | .198                | .905                | .875                  | .905                         | .908                  |
| 13         | C                  | .8750                                   | .820                        | .773                          | .469              | .514                | .925               | .885                 | .153              | .198                | 1.093               | 1.007                 | .905                         | .908                  |
| 15         | D                  | 1.0000                                  | .820                        | .773                          | .469              | .514                | 1.050              | 1.100                | .153              | .198                | 1.219               | 1.140                 | .905                         | .908                  |
| 17         | E                  | 1.1875                                  | .820                        | .773                          | .469              | .514                | 1.238              | 1.197                | .153              | .198                | 1.375               | 1.229                 | .905                         | .908                  |
| 19         | F                  | 1.2500                                  | .820                        | .773                          | .469              | .514                | 1.300              | 1.260                | .153              | .198                | 1.469               | 1.380                 | .905                         | .908                  |
| 21         | G                  | 1.3750                                  | .790                        | .741                          | .500              | .545                | 1.425              | 1.385                | .183              | .228                | 1.625               | 1.493                 | .905                         | .904                  |
| 23         | H                  | 1.5000                                  | .790                        | .741                          | .500              | .545                | 1.550              | 1.510                | .183              | .228                | 1.750               | 1.626                 | .905                         | .904                  |
| 25         | J                  | 1.6250                                  | .790                        | .741                          | .500              | .545                | 1.675              | 1.635                | .183              | .228                | 1.875               | 1.777                 | .905                         | .904                  |

Millimeters

| Shell Size | MS Shell Size Coded | M<br>+.00<br>-.13<br>(TV) | M'<br>+.00<br>-.13<br>(CTV) | L<br>Max<br>(TV) | L'<br>Max<br>(CTV) | S<br>±.25<br>(TV) | S'<br>±.25<br>(CTV) | V<br>Thread<br>Metric | Z<br>Max<br>(TV) | Z'<br>Max<br>(CTV) | GG<br>±.25<br>(TV) | GG'<br>±.25<br>(CTV) | LL<br>+.15<br>-.00<br>(TV) | LL'<br>±.13<br>(CTV) |
|------------|---------------------|---------------------------|-----------------------------|------------------|--------------------|-------------------|---------------------|-----------------------|------------------|--------------------|--------------------|----------------------|----------------------------|----------------------|
| 9          | A                   | 20.83                     | 19.63                       | 11.91            | 13.06              | 17.15             | 16.13               | M12X1-6g              | 3.89             | 5.03               | 20.62              | 17.75                | 22.99                      | 23.06                |
| 11         | B                   | 20.83                     | 19.63                       | 11.91            | 13.06              | 20.32             | 19.43               | M15X1-6g              | 3.89             | 5.03               | 22.99              | 22.22                | 22.99                      | 23.06                |
| 13         | C                   | 20.83                     | 19.63                       | 11.91            | 13.06              | 23.50             | 22.47               | M18X1-6g              | 3.89             | 5.03               | 27.76              | 25.57                | 22.99                      | 23.06                |
| 15         | D                   | 20.83                     | 19.63                       | 11.91            | 13.06              | 26.67             | 27.94               | M22X1-6g              | 3.89             | 5.03               | 30.96              | 28.95                | 22.99                      | 23.06                |
| 17         | E                   | 20.83                     | 19.63                       | 11.91            | 13.06              | 31.45             | 30.40               | M25X1-6g              | 3.89             | 5.03               | 34.93              | 31.21                | 22.99                      | 23.06                |
| 19         | F                   | 20.83                     | 19.63                       | 11.91            | 13.06              | 33.02             | 32.00               | M28X1-6g              | 3.89             | 5.03               | 37.31              | 35.05                | 22.99                      | 23.06                |
| 21         | G                   | 20.07                     | 18.82                       | 12.70            | 13.84              | 36.20             | 35.18               | M31X1-6g              | 4.65             | 5.79               | 41.28              | 37.92                | 22.99                      | 22.96                |
| 23         | H                   | 20.07                     | 18.82                       | 12.70            | 13.84              | 39.37             | 38.35               | M34X1-6g              | 4.65             | 5.79               | 44.45              | 41.30                | 22.99                      | 22.96                |
| 25         | J                   | 20.07                     | 18.82                       | 12.70            | 13.84              | 42.55             | 41.53               | M37X1-6g              | 4.65             | 5.79               | 47.63              | 45.13                | 22.99                      | 22.96                |

All dimensions for reference only

# TV09R – crimp, metal flange mounting plug

Part number reference.  
See how to order, page 43 to complete.  
TV09RW-XX-XXX  
TVS09RF-XX-XXX



† Blue band indicates rear release contact retention system

Inches

| Shell Size | MS Shell Size Coded | B Thread 0.1P-0.3L-TS-2A (Plated) | G ±.060 | Q Dia. Max | R     | GG Dia. ±.005 |
|------------|---------------------|-----------------------------------|---------|------------|-------|---------------|
| 9**        | A                   | .6250                             | 1.106   | .859       | 1.038 | 1.838         |
| 11         | B                   | .7500                             | 1.106   | .969       | 1.115 | 1.948         |
| 13**       | C                   | .8750                             | 1.106   | 1.141      | 1.240 | 2.124         |
| 15         | D                   | 1.0000                            | 1.106   | 1.266      | 1.327 | 2.248         |
| 17         | E                   | 1.1875                            | 1.106   | 1.391      | 1.417 | 2.375         |
| 19         | F                   | 1.2500                            | 1.356   | 1.500      | 1.557 | 2.495         |
| 21         | G                   | 1.3750                            | 1.356   | 1.625      | 1.624 | 2.568         |
| 23         | H                   | 1.5000                            | 1.356   | 1.750      | 1.713 | 2.723         |
| 25         | J                   | 1.6250                            | 1.356   | 1.875      | 1.801 | 2.848         |

Millimeters

| Shell Size | MS Shell Size Code | G ±1.52 | Q Dia. Max | R     | GG Dia. ±.13 |
|------------|--------------------|---------|------------|-------|--------------|
| 9**        | A                  | 28.09   | 21.82      | 26.37 | 46.69        |
| 11         | B                  | 28.09   | 24.62      | 28.32 | 49.48        |
| 13**       | C                  | 28.09   | 28.98      | 31.50 | 53.95        |
| 15         | D                  | 28.09   | 32.16      | 33.71 | 57.10        |
| 17         | E                  | 28.09   | 35.33      | 35.99 | 60.33        |
| 19         | F                  | 34.44   | 38.10      | 39.55 | 63.37        |
| 21         | G                  | 34.44   | 41.28      | 41.25 | 65.23        |
| 23         | H                  | 34.44   | 44.45      | 43.51 | 69.16        |
| 25         | J                  | 34.44   | 47.63      | 45.75 | 72.34        |

All dimensions for reference only

\*\* Partially tooled. Consult Amphenol Aerospace for availability



Designates true position dimensioning



# TVPS02Y (D38999/21) – hermetic, metal box mounting receptacle

Part number reference.  
See how to order, pages 43, 44 to complete.  
TVPS02Y-XX-XXX  
TVPS02YN-XX-XXX  
D38999/21



† Red band indicates fully mated

NOTE: Consult Amphenol Aerospace for availability of non-glass-sealed versions with printed circuit tail contacts.

Inches

| Shell Size | MS Shell Size Code | B Thread Class 2A 0.1P-0.3L-TS (Plated) | R1    | R2    | S ±.010 | T ±.008 | TT ±.008 |
|------------|--------------------|---|-------|-------|---------|---------|----------|
| 9          | A                  | .6250                                   | .719  | .594  | .938    | .128    | .216     |
| 11         | B                  | .7500                                   | .812  | .719  | 1.031   | .128    | .194     |
| 13         | C                  | .8750                                   | .906  | .812  | 1.125   | .128    | .194     |
| 15         | D                  | 1.0000                                  | .969  | .906  | 1.219   | .128    | .173     |
| 17         | E                  | 1.1875                                  | 1.062 | .969  | 1.312   | .128    | .194     |
| 19         | F                  | 1.2500                                  | 1.156 | 1.062 | 1.438   | .128    | .194     |
| 21         | G                  | 1.3750                                  | 1.250 | 1.156 | 1.562   | .128    | .194     |
| 23         | H                  | 1.5000                                  | 1.375 | 1.250 | 1.688   | .154    | .242     |
| 25         | J                  | 1.6250                                  | 1.500 | 1.375 | 1.812   | .154    | .242     |

Millimeters

| Shell Size | MS Shell Size Code | R1    | R2    | S ±.25 | T ±.20 | TT ±.20 |
|------------|--------------------|-------|-------|--------|--------|---------|
| 9          | A                  | 18.26 | 15.09 | 23.83  | 3.25   | 5.49    |
| 11         | B                  | 20.62 | 18.26 | 26.19  | 3.25   | 4.93    |
| 13         | C                  | 23.01 | 20.62 | 28.58  | 3.25   | 4.93    |
| 15         | D                  | 24.61 | 23.01 | 30.96  | 3.25   | 4.39    |
| 17         | E                  | 26.97 | 24.61 | 33.32  | 3.25   | 4.93    |
| 19         | F                  | 29.36 | 26.97 | 36.53  | 3.25   | 4.93    |
| 21         | G                  | 31.75 | 29.36 | 39.67  | 3.25   | 4.93    |
| 23         | H                  | 34.93 | 31.75 | 42.88  | 3.91   | 6.15    |
| 25         | J                  | 38.10 | 34.93 | 46.02  | 3.91   | 6.15    |

All dimensions for reference only

□ Designates true position dimensioning

# TVS07Y (D38999/23) – hermetic, metal jam nut receptacle

Part number reference.  
See how to order, pages 43, 44 to complete.  
TVS07Y-XX-XXX  
TVS07YN-XX-XXX  
D38999/23



† Red band indicates fully mated  
★ .059 dia min. 3 lockwire holes  
1.5 dia min. Formed lockwire hole design (6 holes) is optional.

Inches

| Shell Size | MS Shell Size Code | A*<br>+.000<br>-.010 | B Thread Class 2A<br>0.1P-0.3L-TS<br>(Plated) | C<br>Max | D1<br>+.010<br>-.000 | D2<br>+.000<br>-.010 | H Hex<br>+.017<br>-.016 | L<br>Max | S<br>±.010 | T*<br>+.010<br>-.000 | KK<br>+.011<br>-.000 |
|------------|--------------------|----------------------|---|----------|----------------------|----------------------|-------------------------|----------|------------|----------------------|----------------------|
| 9          | A                  | .669                 | .6250   | 1.199    | .700                 | .670                 | .875                    | .357     | 1.062      | .697                 | .642                 |
| 11         | B                  | .769                 | .7500   | 1.386    | .825                 | .770                 | 1.000                   | .357     | 1.250      | .822                 | .766                 |
| 13         | C                  | .955                 | .8750   | 1.511    | 1.010                | .955                 | 1.188                   | .357     | 1.375      | 1.007                | .892                 |
| 15         | D                  | 1.084                | 1.0000  | 1.636    | 1.135                | 1.085                | 1.312                   | .357     | 1.500      | 1.134                | 1.018                |
| 17         | E                  | 1.208                | 1.1875  | 1.761    | 1.260                | 1.210                | 1.438                   | .357     | 1.625      | 1.259                | 1.142                |
| 19         | F                  | 1.333                | 1.2500  | 1.949    | 1.385                | 1.335                | 1.562                   | .381     | 1.182      | 1.384                | 1.268                |
| 21         | G                  | 1.459                | 1.3750  | 2.073    | 1.510                | 1.460                | 1.688                   | .381     | 1.938      | 1.507                | 1.392                |
| 23         | H                  | 1.575                | 1.5000  | 2.199    | 1.635                | 1.585                | 1.812                   | .381     | 2.062      | 1.634                | 1.518                |
| 25         | J                  | 1.709                | 1.6250  | 2.323    | 1.760                | 1.710                | 2.000                   | .381     | 2.188      | 1.759                | 1.642                |

Millimeters

| Shell Size | MS Shell Size Code | A*<br>+.00<br>-.25 | C<br>Max | D1<br>+.25<br>-.00 | D2<br>+.00<br>-.25 | H Hex<br>+.43<br>-.41 | L<br>Max | S<br>±.25 | T*<br>+.25<br>-.00 | KK<br>+.28<br>-.00 |
|------------|--------------------|--------------------|----------|--------------------|--------------------|-----------------------|----------|-----------|--------------------|--------------------|
| 9          | A                  | 16.99              | 30.45    | 17.78              | 17.02              | 22.23                 | 9.07     | 26.97     | 17.70              | 16.31              |
| 11         | B                  | 19.53              | 35.20    | 20.96              | 19.59              | 25.40                 | 9.07     | 31.75     | 20.88              | 19.46              |
| 13         | C                  | 24.26              | 38.38    | 25.65              | 24.26              | 30.18                 | 9.07     | 34.93     | 25.58              | 22.66              |
| 15         | D                  | 27.53              | 41.55    | 28.83              | 27.56              | 33.32                 | 9.07     | 38.10     | 28.80              | 25.86              |
| 17         | E                  | 30.68              | 44.73    | 32.01              | 30.73              | 36.53                 | 9.07     | 41.28     | 31.98              | 29.01              |
| 19         | F                  | 33.86              | 49.50    | 35.18              | 33.91              | 39.67                 | 9.68     | 46.02     | 35.15              | 32.21              |
| 21         | G                  | 37.06              | 52.65    | 38.35              | 37.08              | 42.80                 | 9.68     | 49.23     | 38.28              | 35.36              |
| 23         | H                  | 40.01              | 55.85    | 41.53              | 40.26              | 46.02                 | 9.68     | 52.37     | 41.50              | 38.56              |
| 25         | J                  | 43.41              | 59.00    | 44.70              | 43.43              | 50.80                 | 9.68     | 55.58     | 44.68              | 41.71              |

All dimensions for reference only

• D shaped panel cut-out dimensions

# TVSIY (D38999/25) – hermetic, metal solder mounting receptacle

Part number reference.  
See how to order, pages 43, 44 to complete.  
TVSIY-XX-XXX  
TVSIYN-XX-XXX  
D38999/25

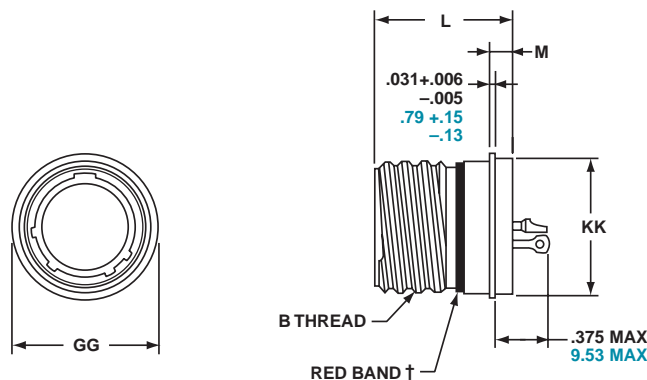

† Red band indicates fully mated

Inches

| Shell Size | MS Shell Size Code | B Thread Class 2A 0.1P-0.3L-TS (Plated) | L<br>+.011<br>-.005 | M<br>+.006<br>-.005 | GG Dia.<br>+.011<br>-.010 | KK Dia.<br>+.001<br>-.005 |
|------------|--------------------|---|---------------------|---------------------|---------------------------|---------------------------|
| 9          | A                  | .6250                                   | .806                | .125                | .750                      | .672                      |
| 11         | B                  | .7500                                   | .806                | .125                | .844                      | .781                      |
| 13         | C                  | .8750                                   | .806                | .125                | .969                      | .906                      |
| 15         | D                  | 1.0000                                  | .806                | .125                | 1.094                     | 1.031                     |
| 17         | E                  | 1.1875                                  | .806                | .125                | 1.218                     | 1.156                     |
| 19         | F                  | 1.2500                                  | .806                | .125                | 1.312                     | 1.250                     |
| 21         | G                  | 1.3750                                  | .806                | .125                | 1.438                     | 1.375                     |
| 23         | H                  | 1.5000                                  | .838                | .156                | 1.563                     | 1.500                     |
| 25         | J                  | 1.6250                                  | .838                | .156                | 1.688                     | 1.625                     |

Millimeters

| Shell Size | MS Shell Size Code | L<br>+.28<br>-.00 | M<br>+.15<br>-.13 | GG Dia.<br>+.28<br>-.25 | KK Dia.<br>+.03<br>-.13 |
|------------|--------------------|-------------------|-------------------|-------------------------|-------------------------|
| 9          | A                  | 20.47             | 3.18              | 19.05                   | 17.07                   |
| 11         | B                  | 20.47             | 3.18              | 21.44                   | 19.84                   |
| 13         | C                  | 20.47             | 3.18              | 24.61                   | 23.01                   |
| 15         | D                  | 20.47             | 3.18              | 27.79                   | 26.19                   |
| 17         | E                  | 20.47             | 3.18              | 30.94                   | 29.36                   |
| 19         | F                  | 20.47             | 3.18              | 33.32                   | 31.75                   |
| 21         | G                  | 20.47             | 3.18              | 36.53                   | 34.93                   |
| 23         | H                  | 21.29             | 3.96              | 39.70                   | 38.10                   |
| 25         | J                  | 21.29             | 3.96              | 42.88                   | 41.28                   |

All dimensions for reference only

# TVSHIY (D38999/27) – hermetic, metal weld mounting receptacle

Part number reference.  
See how to order, pages 43, 44 to complete.  
TVSHIY-XX-XXX  
TVSHIYN-XX-XXX  
D38999/27



† Red band indicates fully mated

Inches

| Shell Size | MS Shell Size Code | B Thread Class 2A 0.1P-0.3L-TS (Plated) | L<br>+.011<br>-.000 | M<br>+.006<br>-.005 | GG Dia.<br>+.010<br>-.000 |
|------------|--------------------|---|---------------------|---------------------|---------------------------|
| 9          | A                  | .6250                                   | .806                | .125                | .973                      |
| 11         | B                  | .7500                                   | .806                | .125                | 1.095                     |
| 13         | C                  | .8750                                   | .806                | .125                | 1.221                     |
| 15         | D                  | 1.0000                                  | .806                | .125                | 1.347                     |
| 17         | E                  | 1.1875                                  | .806                | .125                | 1.434                     |
| 19         | F                  | 1.2500                                  | .806                | .125                | 1.579                     |
| 21         | G                  | 1.3750                                  | .806                | .125                | 1.721                     |
| 23         | H                  | 1.5000                                  | .838                | .156                | 1.886                     |
| 25         | J                  | 1.6250                                  | .838                | .156                | 1.973                     |

Millimeters

| Shell Size | MS Shell Size Code | L<br>+.28<br>-.00 | M<br>+.15<br>-.13 | GG Dia.<br>+.25<br>-.00 |
|------------|--------------------|-------------------|-------------------|-------------------------|
| 9          | A                  | 20.47             | 3.18              | 24.71                   |
| 11         | B                  | 20.47             | 3.18              | 27.81                   |
| 13         | C                  | 20.47             | 3.18              | 31.01                   |
| 15         | D                  | 20.47             | 3.18              | 34.21                   |
| 17         | E                  | 20.47             | 3.18              | 36.42                   |
| 19         | F                  | 20.47             | 3.18              | 40.11                   |
| 21         | G                  | 20.47             | 3.18              | 43.71                   |
| 23         | H                  | 21.29             | 3.96              | 47.90                   |
| 25         | J                  | 21.29             | 3.96              | 50.11                   |

All dimensions for reference only

# TV Breakaway Fail Safe Connectors

## quick-disconnect with an axial pull of lanyard

**Amphenol Tri-Start Breakaway Fail Safe Connectors provide unequalled performance in environments requiring instant disengagement.**

Designed to provide quick disconnect of a connector plug and receptacle with an axial pull on the lanyard, the “Breakaway” Fail Safe connector family offers a wide range of electrical and mechanical features:

- Instant decoupling and damage free separation
- Completely intermateable with standard receptacles (D38999/20 and /24)
- Inventory support commonality through the use of standard insert arrangements and contacts

Breakaway un-mating is initiated by applying a pull force to the lanyard which causes the operating sleeve on the plug to move away from the receptacle. Coupling segments on the plug then move away from the mating receptacle while expanding, thus releasing the receptacle. After completion of the un-mating sequence, spring compression returns the sleeve and segments to their original positions. Un-mating of the plug may also be accomplished by normal rotation of the coupling ring without affecting the breakaway capability.

**The Tri-Start Breakaway Fail Safe connector features which provide EMI/EMP shielding in excess of MIL-DTL-38999 Series III requirements:**

- Solid metal-to-metal coupling
- EMI grounding fingers
- Conductive finishes

**Amphenol Breakaway Fail Safe connectors are qualified to MIL-DTL-38999/29, /30 and /31 (for MIL-STD-1760 Stores Management applications). In fact, Amphenol offers more qualified Breakaway shell size and insert combinations than any other QPL supplier.**

In addition to standard Breakaway connectors, Amphenol also manufactures custom breakaway connectors including those with:

- Highly durable non-metallic operating sleeves in a variety of lengths and diameters
- Increased pull-force capability
- Low-profile designs
- Custom lanyard lengths and backshells
- Low force separation capabilities
- Low insertion/separation force contacts
- Non-cadmium finishes

Whether you need a standard Breakaway, one of our custom Breakaways or, a unique Breakaway design, please contact your local Amphenol representative.

Contact Amphenol Aerospace for more information on breakaway, quick-disconnect connectors. Other Amphenol cylindrical families (MIL-DTL-38999 Series I & II, MIL-C-26482, MIL-C-83723) also offer breakaway quick-disconnect connectors.

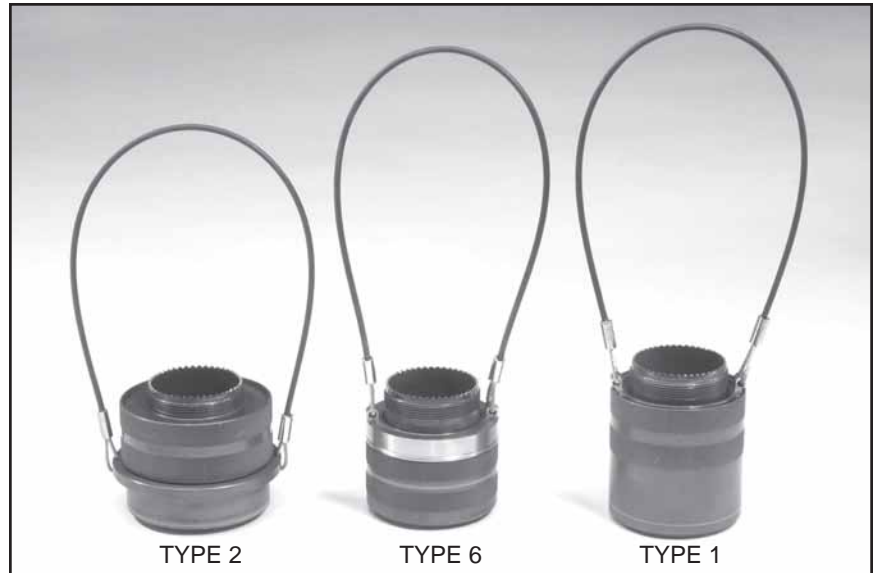

**Amphenol offers a variety of lanyard plug styles including MIL-STD-1760 types 1, 2 and 6 for Stores Management applications.**



**Breakaway with Coax Contacts**



**Special configuration Fail Safe used on space telescope application.** Lanyard is replaced by a swivel ring for remote disconnect and “wing arms” have been added for manual actuation accessibility by gloved astronauts.

# D38999/29 & D38999/30 TV Breakaway Fail Safe – crimp, metal lanyard release plug

Part number reference.  
See how to order, pages 29, 30  
to complete.  
D38999/29 (Pins Only)  
D38999/30 (Sockets Only)  
88-5565XX-XX  
91-5565XX-XX



† Blue band indicates rear release contact retention system

Inches

| Shell Size | MS Shell Size Code | B Max | D Max Accessory Dia. |
|------------|--------------------|-------|----------------------|
| 11         | B                  | 1.846 | 1.109                |
| 13         | C                  | 1.972 | 1.250                |
| 15         | D                  | 2.079 | 1.375                |
| 17         | E                  | 2.205 | 1.500                |
| 19         | F                  | 2.301 | 1.625                |
| 21         | G                  | 2.472 | 1.750                |
| 23         | H                  | 2.594 | 1.875                |
| 25         | J                  | 2.705 | 2.000                |

Millimeters

| Shell Size | MS Shell Size Code | B Max | D Max Accessory Dia. | V Thread Metric |
|------------|--------------------|-------|----------------------|-----------------|
| 11         | B                  | 46.89 | 28.17                | M15X1.0-6g      |
| 13         | C                  | 50.09 | 31.75                | M18X1.0-6g      |
| 15         | D                  | 52.81 | 34.93                | M22X1.0-6g      |
| 17         | E                  | 56.01 | 38.10                | M25X1.0-6g      |
| 19         | F                  | 58.45 | 41.28                | M28X1.0-6g      |
| 21         | G                  | 62.79 | 44.45                | M31X1.0-6g      |
| 23         | H                  | 65.89 | 47.63                | M34X1.0-6g      |
| 25         | J                  | 68.71 | 50.08                | M37X1.0-6g      |

All dimensions for reference only

# D38999/29 & D38999/30 TV Breakaway Fail Safe lanyard release plug insert availability, how to order

## INSERT AVAILABILITY

| Insert Arrangement | Service Rating | Total Contacts | Contact Size |    |    |    |         |         |          |
|--------------------|----------------|----------------|--------------|----|----|----|---------|---------|----------|
|                    |                |                | 22D          | 20 | 16 | 12 | 12 Coax | 8 Coax* | 8 Twinax |
| 11-2               | I              | 2              |              |    | 2  |    |         |         |          |
| 11-35              | M              | 13             | 13           |    |    |    |         |         |          |
| 11-98              | I              | 6              |              | 6  |    |    |         |         |          |
| 13-4               | I              | 4              |              |    | 4  |    |         |         |          |
| 13-8               | I              | 8              |              | 8  |    |    |         |         |          |
| 13-35              | M              | 22             | 22           |    |    |    |         |         |          |
| 13-98              | I              | 10             |              | 10 |    |    |         |         |          |
| 15-5               | II             | 5              |              |    | 5  |    |         |         |          |
| 15-15              | I              | 15             |              | 14 | 1  |    |         |         |          |
| 15-18              | I              | 18             |              | 18 |    |    |         |         |          |
| 15-19              | I              | 19             |              | 19 |    |    |         |         |          |
| 15-35              | M              | 37             | 37           |    |    |    |         |         |          |
| 15-97              | I              | 12             |              | 8  | 4  |    |         |         |          |
| 17-6               | I              | 6              |              |    |    | 6  |         |         |          |
| 17-8               | II             | 8              |              |    | 8  |    |         |         |          |
| 17-26              | I              | 26             |              | 26 |    |    |         |         |          |
| 17-35              | M              | 55             | 55           |    |    |    |         |         |          |
| 17-99              | I              | 23             |              | 21 | 2  |    |         |         |          |
| 19-11              | II             | 11             |              |    | 11 |    |         |         |          |
| 19-32              | I              | 32             |              | 32 |    |    |         |         |          |
| 19-35              | M              | 66             | 66           |    |    |    |         |         |          |
| 21-11              | I              | 11             |              |    |    | 11 |         |         |          |
| 21-16              | II             | 16             |              |    | 16 |    |         |         |          |
| 21-35              | M              | 79             | 79           |    |    |    |         |         |          |
| 21-39              | I              | 39             |              | 37 | 2  |    |         |         |          |
| 21-41              | I              | 41             |              | 41 |    |    |         |         |          |
| 23-21              | II             | 21             |              |    | 21 |    |         |         |          |
| 23-35              | M              | 100            | 100          |    |    |    |         |         |          |
| 23-53              | I              | 53             |              | 53 |    |    |         |         |          |
| 23-54              | M              | 53             | 40           |    | 9  | 4  |         |         |          |
| 23-55              | I              | 55             |              | 55 |    |    |         |         |          |
| 25-4               | I              | 56             |              | 48 | 8  |    |         |         |          |
| 25-19              | I              | 19             |              |    |    | 19 |         |         |          |
| 25-20              | N              | 30             |              | 10 | 13 |    | 4       |         | 3        |
| 25-24              | I              | 24             |              |    | 12 | 12 |         |         |          |
| 25-29              | I              | 29             |              |    | 29 |    |         |         |          |
| 25-35              | M              | 128            | 128          |    |    |    |         |         |          |
| 25-43              | I              | 43             |              | 23 | 20 |    |         |         |          |
| 25-46              | I              | 46             |              | 40 | 4  |    |         | 2*      |          |
| 25-61              | I              | 61             |              | 61 |    |    |         |         |          |

| Tri-Start Lanyard Separation Forces |                           |                            |
|-------------------------------------|---------------------------|----------------------------|
| Shell Size                          | Straight Pull (lbs. max.) | 15 Degree Pull (lbs. max.) |
| 11<br>13<br>15                      | 45                        | 55                         |
| 17<br>19<br>21<br>23<br>25          | 90                        | 100                        |

\* For RG 180/U and RG 195/U cables only. (Check Amphenol, Sidney, NY for other cable applications. For availability of other insert arrangements consult Amphenol, Sidney, NY. For accessories for lanyard release plugs see page 33.

TABLE I  
INSERT ARRANGEMENT CODE

| Basic Part Number | MIL-DTL-38999 Insert Arrangement |
|-------------------|----------------------------------|
| 88/91-556508      | 11-2                             |
| 06                | 11-35                            |
| 07                | 11-98                            |
| 10                | 13-4                             |
| 11                | 13-8                             |
| 13                | 13-98                            |
| 14                | 13-35                            |
| 18                | 15-5                             |
| 23                | 15-15                            |
| 22                | 15-18                            |
| 19                | 15-19                            |
| 20                | 15-35                            |
| 27                | 17-6                             |
| 28                | 17-8                             |
| 29                | 17-26                            |
| 30                | 17-35                            |
| 31                | 17-99                            |
| 37                | 19-11                            |
| 39                | 19-32                            |
| 40                | 19-35                            |
| 47                | 21-11                            |
| 48                | 21-16                            |
| 49                | 21-35                            |
| 50                | 21-41                            |
| 51                | 21-39                            |
| 57                | 23-21                            |
| 58                | 23-35                            |
| 59                | 23-53                            |
| 61                | 23-54                            |
| 60                | 23-55                            |
| 66                | 25-19                            |
| 74                | 25-20                            |
| 67                | 25-29                            |
| 68                | 25-35                            |
| 69                | 25-43                            |
| 70                | 25-61                            |
| 71                | 25-4                             |
| 72                | 25-24                            |

TABLE II  
LANYARD LENGTH CODES

| Lanyard Length (in.) ± .236 | Lanyard Length (mm) ± 6.0 | Lanyard Length Code For Part Number |
|-----------------------------|---------------------------|-------------------------------------|
| 4.016                       | 102                       | A                                   |
| 4.528                       | 115                       | B                                   |
| 5.000                       | 127                       | C                                   |
| 5.512                       | 140                       | D                                   |
| 6.024                       | 153                       | E                                   |
| 6.535                       | 166                       | F                                   |
| 7.008                       | 178                       | G                                   |
| 7.520                       | 191                       | H                                   |
| 7.992                       | 203                       | I                                   |
| 8.503                       | 216                       | J                                   |
| 9.016                       | 229                       | K                                   |
| 9.528                       | 242                       | L                                   |
| 10.000                      | 254                       | M                                   |
| 10.512                      | 267                       | N                                   |
| 11.024                      | 280                       | P                                   |
| 11.535                      | 293                       | R                                   |
| 12.008                      | 305                       | S                                   |
| 12.520                      | 318                       | T                                   |
| 13.031                      | 331                       | U                                   |
| 14.016                      | 356                       | V                                   |
| 15.000                      | 381                       | W                                   |
| 16.024                      | 407                       | X                                   |
| 17.008                      | 432                       | Y                                   |
| 18.031                      | 458                       | Z                                   |

# D38999/29 & D38999/30

## TV Breakaway Fail Safe

### lanyard release plug – how to order, cont.

#### HOW TO ORDER - BY MILITARY PART NUMBER

##### FAIL SAFE D38999/29 & D38999/30

Ordering procedure for example part number D38999/29FB35EN is shown below:

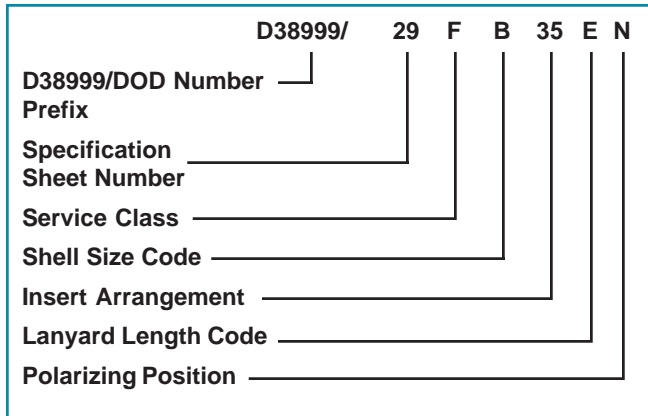

#### DOD Number Prefix

D38999/ designates MIL-DTL-38999, Series III Tri-Start Connectors

#### Specification Sheet Number

29 designates Lanyard Release Plug with pin contacts  
30 designates Lanyard Release Plug with socket contacts

#### Service Class

F designates electroless nickel plated aluminum, optimum EMI shielding effectiveness –65dB @ 10 GHz specification min., 48 hour salt spray, 200°C  
W designates corrosion resistant olive drab cadmium plate aluminum, 500 hour extended salt spray, EMI –50dB @ 10 GHz specification min., 175°C

#### Shell Size Code

MIL-DTL-38999, Sizes 11 thru 25

| A* | B  | C  | D  | E  | F  | G  | H  | J  | MIL Shell Size      |
|----|----|----|----|----|----|----|----|----|---------------------|
| 9* | 11 | 13 | 15 | 17 | 19 | 21 | 23 | 25 | Amphenol Shell Size |

\* Shell size 9 not available

#### Insert Arrangement

MIL-DTL-38999, see insert availability chart on page 29.

#### Lanyard Length Code

See Table II (page 29) for lanyard length code number.

#### Polarizing Position

For alternate positions of connector (to prevent cross-mating) see alternate positioning on page 8. (N indicates normal)

#### HOW TO ORDER - BY PROPRIETARY PART NUMBER

##### FAIL SAFE 88-5565( ) & 91-5565( )

Ordering procedure for example part number 88-556529-EP is shown below:

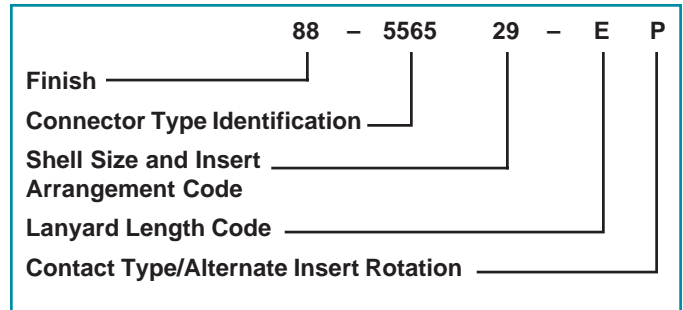

#### Finish

88 designates corrosion resistant olive drab cadmium plate over nickel, 500 hour extended salt spray, EMI –50dB @ 10 GHz specification min., 175°C

91 designates electroless nickel plated aluminum, optimum EMI shielding effectiveness –65dB @ 10 GHz specification min., 48 hour salt spray, 200°C

These are standard finishes. Consult Amphenol Aerospace, Sidney, NY for variations.

#### Connector Type Identification

88/91-5565 designates MIL-DTL-38999, Series III Tri-Start Lanyard Release Plug

#### Shell Size and Insert Arrangement Code

Shell sizes are MIL-DTL-38999, Series III from 11 thru 25. The basic part number selected specifies the insert arrangement. See Table I (page 29) for coded part number that correlates to insert arrangement.

#### Lanyard Length Code

See Table II (page 29) for lanyard length code number.

#### Contact Type/Alternate Rotations

P designates pin, S designates socket for normal positioning of contacts. When an alternate position of the connector is required to prevent cross-mating, a different letter (other than P or S) is used. See alternate positioning on page 8, then convert to Amphenol proprietary coding by the following chart.

| Pin Contacts |                 | Socket Contacts |                 |
|--------------|-----------------|-----------------|-----------------|
| MS Letter    | Amphenol Letter | MS Letter       | Amphenol Letter |
| PN           | P (normal)      | SN              | S (normal)      |
| PA           | G               | SA              | H               |
| PB           | I               | SB              | J               |
| PC           | K               | SC              | L               |
| PD           | M               | SD              | N               |
| PE           | R               | SE              | T               |



# D38999/31 for MIL-STD-1760 TV Breakaway Fail Safe – crimp, metal lanyard release plug

PIN CONTACTS ONLY,  
SHELL SIZE 25 ONLY

Part number reference.  
See how to order, page 32 to  
complete.

D38999/31

88-555875/76 } Type 6  
91-555875/76 }

88-558518/19 } Type 2  
91-558518/19 }

T3W-16B25-XXXX — Type 1



TYPE 6

TYPE 2

| Tri-Start Lanyard Separation Forces |                           |                            |
|-------------------------------------|---------------------------|----------------------------|
| Shell Size                          | Straight Pull (lbs. max.) | 15 Degree Pull (lbs. max.) |
| 25                                  | 90                        | 100                        |



TYPE 1 (LONGER SHELL)

† Blue band indicates rear release contact retention system  
\*\* Lanyard pulled taut against a .500 ± .13 dia. mandrel  
All dimensions for reference only

### Pin Contact Data for MIL-STD-1760

| Insert Arrangement | Service Rating | Total Contacts | Contact |    |           |            |
|--------------------|----------------|----------------|---------|----|-----------|------------|
|                    |                |                | 20      | 16 | 12 (coax) | 8 (twinax) |
| 25-20              | N              | 30             | 10      | 13 | 4         | 3          |

### Contacts for 25-20 Pattern

| Shell Size | Arrangement Number | Number of Contacts | Size Contacts                | Service Rating | Contact Location                      | Standard Contact |                |
|------------|--------------------|--------------------|------------------------------|----------------|---------------------------------------|------------------|----------------|
|            |                    |                    |                              |                |                                       | Pin              | Socket         |
| 25         | -20                | 3                  | 8                            | Twinax         | A, H, K                               | M39029/90-529    | M39029/91-530  |
|            |                    | 4                  | 12                           | Coax           | 2, 3                                  | M39029/28-211    | M39029/75-416  |
|            |                    |                    |                              |                | W, 5                                  | M39029/102-558   | M39029/103-559 |
|            |                    | 13                 | 16                           | N              | C, D, E, F, J, M, N, P, R, T, U, Y, Z | M39029/58-364    | M39029/56-352  |
| 10         | 20                 | N                  | B, G, L, S, V, X, 1, 4, 6, 7 | M39029/58-363  | M39029/56-351                         |                  |                |

| Insert Arrangement | Service Rating | Total Contacts | Contact Size |            |
|--------------------|----------------|----------------|--------------|------------|
|                    |                |                | 20           | 10 (power) |
| 25-11              | N              | 11             | 2            | 9          |

### INSERT AVAILABILITY FAIL SAFE D38999/31 FOR MIL-STD-1760

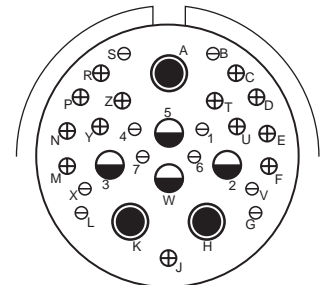

25-20

Primary Interface Signal Set

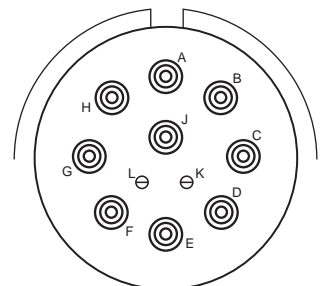

25-11

Auxillary Power Signal Set

Contact Legend

|            |            |           |    |    |
|------------|------------|-----------|----|----|
|            |            |           |    |    |
| 8 (twinax) | 10 (power) | 12 (coax) | 16 | 20 |

# D38999/31 for MIL-STD-1760 TV Breakaway Fail Safe for Stores Management applications lanyard release plug – how to order

## HOW TO ORDER - BY MILITARY PART NUMBER FAIL SAFE D38999/31

Ordering procedure for example part number D38999/31WE20PN1 is shown below:



### DOD Number Prefix

D38999/ designates MIL-DTL-38999, Series III Tri-Start Connectors

### Specification Sheet Number

31 designates Lanyard Release Plug for MIL-STD-1760 with pin contacts

### Service Class

F designates electroless nickel plated aluminum, optimum EMI shielding effectiveness –65dB @ 10 GHz specification min., 48 hour salt spray, 200°C

W designates corrosion resistant olive drab cadmium plate aluminum, 500 hour extended salt spray, EMI –50dB @ 10 GHz specification min., 175°C

### Lanyard Length Code

See Table III for lanyard length code number.

### Insert Arrangement

Only 11 or 20 are available contact arrangement numbers. See page 31.

### Contact Style

Only P and A are valid contact style options. P replaces the “no designation” option in the PIN on revision C and earlier revisions of the Mil-Spec. A designates supplied less contacts.

### Polarizing Positions

N is required for normal position.

### Type Number

Type 1, 2 or 6. See drawings on page 31.

For accessories for lanyard release plugs see page 33.

**TABLE III  
LANYARD LENGTH CODES**

| Lanyard Length (in.)<br>± .236 | Lanyard Length (mm.)<br>± 6.0 | Lanyard Length Code For Part Number |
|--------------------------------|-------------------------------|-------------------------------------|
| 6.024                          | 153.0                         | E                                   |
| 6.535                          | 166.0                         | F                                   |
| 7.008                          | 178.0                         | G                                   |
| 7.520                          | 191.0                         | H                                   |
| 7.992                          | 203.0                         | I                                   |
| 8.504                          | 216.0                         | J                                   |
| 9.016                          | 229.0                         | K                                   |
| 9.528                          | 242.0                         | L                                   |

# TV Breakaway Fail Safe – accessories backshells, dummy contacts, wire combs

Amphenol offers a full range of accessories that are designed to enhance the performance of Amphenol Breakaway connectors.

**Low Profile Backshells in shell size 25 with the following features:**

- Olive drab cadmium finish
- 90 degree termination
- Low profile design with three heights ranging from 1.010 to 1.660
- Rear access covers to help ease harness assembly and repairability
- Amphenol part numbers:  
10-640000-XXX and 10-559672-XXX



Backshells are offered for use with Breakaway Fail Safe Connectors in three heights.

## Dummy Contacts

- Available in size 12 and size 8
- Provide a cost effective alternative for sealing unused contact cavities
- Size 8 part number: T3-4008-59P
- Size 12 part number: T3-4012-59P

## Wire Combs

- Available for the 25-20 insert pattern to help to stabilize and prevent contact side loading
- Amphenol part number: 21-33626-XXX

For information on how to order these accessory products for Breakaway Fail Safe connectors consult Amphenol Aerospace.



Accessory products for Breakaway Connectors:  
Dummy Contacts and Wire Combs

# Tri-Start – accessories

## receptacle protection cap



\* To complete order number, add shell size and suffix number.  
For example, shell size 11 with olive drab cadmium nickel base, 10-552943-119

| Shell Size | A Thread Class 2B<br>0.1P-0.3L-TS | B Dia. Max | D Dia.<br>+.010<br>-.000 |
|------------|-----------------------------------|------------|--------------------------|
| 9          | .6250                             | .875       | .703                     |
| 11         | .7500                             | 1.000      | .844                     |
| 13         | .8750                             | 1.125      | 1.016                    |
| 15         | 1.0000                            | 1.250      | 1.141                    |
| 17         | 1.1875                            | 1.438      | 1.266                    |
| 19         | 1.2500                            | 1.500      | 1.391                    |
| 21         | 1.3750                            | 1.625      | 1.516                    |
| 23         | 1.5000                            | 1.750      | 1.641                    |
| 25         | 1.6250                            | 1.875      | 1.766                    |

| Finish                           | 10-No Suffix |
|----------------------------------|--------------|
| Olive drab, cadmium, nickel base | -XX9         |
| Electroless nickel               | -XXG         |

Consult Amphenol Aerospace for availability of stainless steel protection caps.

All dimensions for reference only.  
For MS protection caps, see page 40.

| Shell Size | MS Shell Size Code | B Dia. Max | D Dia.<br>+.25<br>-.00 |
|------------|--------------------|------------|------------------------|
| 9          | A                  | 22.23      | 17.86                  |
| 11         | B                  | 25.40      | 21.44                  |
| 13         | C                  | 28.58      | 25.81                  |
| 15         | D                  | 31.75      | 28.98                  |
| 17         | E                  | 36.53      | 32.16                  |
| 19         | F                  | 38.10      | 35.33                  |
| 21         | G                  | 41.28      | 38.51                  |
| 23         | H                  | 44.45      | 41.68                  |
| 25         | J                  | 47.63      | 44.86                  |

# Tri-Start - accessories

## plug protection cap

\*10-552944-XXX



\*10-553998-XXX



\* To complete order number, add shell size and suffix number.  
For example, shell size 11 with olive drab cadmium nickel base, 10-552944-119

Inches

| Shell Size | A Thread Class 2B<br>0.1P-0.3L-TS | D Dia.<br>+.010<br>-.000 | N Dia.<br>Max |
|------------|-----------------------------------|--------------------------|---------------|
| 9          | .6250                             | .516                     | .895          |
| 11         | .7500                             | .641                     | 1.000         |
| 13         | .8750                             | .766                     | 1.171         |
| 15         | 1.0000                            | .891                     | 1.299         |
| 17         | 1.1875                            | 1.016                    | 1.436         |
| 19         | 1.2500                            | 1.141                    | 1.543         |
| 21         | 1.3750                            | 1.266                    | 1.670         |
| 23         | 1.5000                            | 1.343                    | 1.787         |
| 25         | 1.6250                            | 1.516                    | 1.914         |

Millimeters

| Finish                           | 10-No Suffix |
|----------------------------------|--------------|
| Olive drab, cadmium, nickel base | -XX9         |
| Electroless nickel               | -XXG         |

| Shell Size | MS Shell Size Code | D Dia.<br>+.25<br>-.00 | N Dia.<br>Max |
|------------|--------------------|------------------------|---------------|
| 9          | A                  | 13.11                  | 22.73         |
| 11         | B                  | 16.28                  | 25.40         |
| 13         | C                  | 19.46                  | 29.74         |
| 15         | D                  | 22.63                  | 32.99         |
| 17         | E                  | 25.81                  | 36.47         |
| 19         | F                  | 28.98                  | 39.19         |
| 21         | G                  | 32.16                  | 42.42         |
| 23         | H                  | 34.11                  | 45.39         |
| 25         | J                  | 38.51                  | 48.62         |

Consult Amphenol Aerospace for availability of stainless steel protection caps.

All dimensions for reference only.  
For MS protection caps, see page 40.

# Tri-Start – accessories dummy receptacle

Part number reference.  
See note below to complete.

\* 10-553974-XXX



\* To complete order number, add shell size and suffix number.  
For example, shell size 11 with olive drab cadmium nickel base, 10-553974-119

| Finish                           | 10-No Suffix |
|----------------------------------|--------------|
| Olive drab, cadmium, nickel base | -XX9         |
| Electroless nickel               | -XXG         |

| Shell Size | MS Shell Size Coded | B Thread Class 2A 0.1P-0.3L-TS (Plated) | M<br>+.020<br>-.000 | Inches         |                | S<br>±.010 | T<br>+.008<br>-.006 | W<br>±.010 | TT<br>+.008<br>-.006 |
|------------|---------------------|---|---------------------|----------------|----------------|------------|---------------------|------------|----------------------|
|            |                     |   |                     | R <sup>1</sup> | R <sup>2</sup> |            |                     |            |                      |
| 9          | A                   | .6250                                   | .822                | .719           | .594           | .938       | .128                | .098       | .216                 |
| 11         | B                   | .7500                                   | .822                | .812           | .719           | 1.031      | .128                | .098       | .194                 |
| 13         | C                   | .8750                                   | .822                | .906           | .812           | 1.125      | .128                | .098       | .194                 |
| 15         | D                   | 1.0000                                  | .822                | .969           | .906           | 1.219      | .128                | .098       | .173                 |
| 17         | E                   | 1.1875                                  | .822                | 1.062          | .969           | 1.312      | .128                | .098       | .194                 |
| 19         | F                   | 1.2500                                  | .822                | 1.156          | 1.062          | 1.438      | .128                | .098       | .194                 |
| 21         | G                   | 1.3750                                  | .791                | 1.250          | 1.156          | 1.562      | .128                | .125       | .194                 |
| 23         | H                   | 1.5000                                  | .791                | 1.375          | 1.250          | 1.688      | .154                | .125       | .242                 |
| 25         | J                   | 1.6250                                  | .791                | 1.500          | 1.375          | 1.812      | .154                | .125       | .242                 |

| Shell Size | MS Shell Size Code | M<br>+.51<br>-.00 | Millimeters    |                | S<br>±.25 | T<br>+.20<br>-.15 | W<br>±.25 | TT<br>+.20<br>-.15 |
|------------|--------------------|-------------------|----------------|----------------|-----------|-------------------|-----------|--------------------|
|            |                    |                   | R <sup>1</sup> | R <sup>2</sup> |           |                   |           |                    |
| 9          | A                  | 20.88             | 18.26          | 15.09          | 23.83     | 3.25              | 2.49      | 5.49               |
| 11         | B                  | 20.88             | 20.62          | 18.26          | 26.19     | 3.25              | 2.49      | 4.93               |
| 13         | C                  | 20.88             | 23.01          | 20.62          | 28.58     | 3.25              | 2.49      | 4.93               |
| 15         | D                  | 20.88             | 24.61          | 23.01          | 30.96     | 3.25              | 2.49      | 4.93               |
| 17         | E                  | 20.88             | 26.97          | 24.61          | 33.32     | 3.25              | 2.49      | 4.93               |
| 19         | F                  | 20.88             | 29.36          | 26.97          | 36.53     | 3.25              | 2.49      | 4.93               |
| 21         | G                  | 20.09             | 31.75          | 29.36          | 39.67     | 3.25              | 3.18      | 4.93               |
| 23         | H                  | 20.09             | 34.93          | 31.75          | 42.88     | 3.91              | 3.18      | 6.15               |
| 25         | J                  | 20.09             | 38.10          | 34.93          | 46.02     | 3.91              | 3.18      | 6.15               |

All dimensions for reference only

  Designates true position dimensioning

# Tri-Start – accessories cable clamps

**Straight Style**  
\*10-552681-XXX metal coupling



**90 Degree Elbow Style**  
\*10-552682-XXX metal coupling



\* To complete order number, see suffix chart below. Examples:

Clamp with metal coupling nut for shell size 11 with olive drab cadmium nickel base, 10-552681-119.

Inches

| Finish                           | 10-No Suffix |
|----------------------------------|--------------|
| Olive drab, cadmium, nickel base | -XX9         |
| Electroless nickel               | -XXG         |

| Shell Size | MS Shell Size Code | F <sup>1</sup> Min. Dia. Cable | F <sup>2</sup> Max. Dia. Cable | L Max. | U Max. | FF Dia. Max. | KK Dia. Max. | LL Max. |
|------------|--------------------|--------------------------------|--------------------------------|--------|--------|--------------|--------------|---------|
| 9          | A                  | .094                           | .203                           | 1.431  | .656   | .347         | .629         | 1.015   |
| 11         | B                  | .141                           | .250                           | 1.431  | .688   | .394         | .756         | 1.062   |
| 13         | C                  | .172                           | .323                           | 1.431  | .750   | .467         | .883         | 1.125   |
| 15         | D                  | .203                           | .422                           | 1.431  | .859   | .566         | 1.011        | 1.328   |
| 17         | E                  | .234                           | .500                           | 1.431  | .937   | .644         | 1.138        | 1.392   |
| 19         | F                  | .265                           | .562                           | 1.431  | 1.000  | .706         | 1.265        | 1.453   |
| 21         | G                  | .297                           | .625                           | 1.492  | 1.062  | .769         | 1.393        | 1.609   |
| 23         | H                  | .328                           | .703                           | 1.492  | 1.141  | .847         | 1.488        | 1.656   |
| 25         | J                  | .359                           | .765                           | 1.492  | 1.203  | .909         | 1.616        | 1.719   |

Millimeters

| Shell Size | MS Shell Size Code | F <sup>1</sup> Min. Dia. Cable | F <sup>2</sup> Max. Dia. Cable | L Max. | U Max. | V Thread Metric | FF Dia. Max. | KK Dia. Max. | LL Max. |
|------------|--------------------|--------------------------------|--------------------------------|--------|--------|-----------------|--------------|--------------|---------|
| 9          | A                  | 2.39                           | 5.16                           | 36.35  | 16.66  | M12X1-6H        | 8.81         | 15.98        | 25.78   |
| 11         | B                  | 3.58                           | 6.35                           | 36.35  | 17.48  | M15X1-6H        | 10.01        | 19.20        | 26.97   |
| 13         | C                  | 4.37                           | 8.20                           | 36.35  | 19.05  | M18X1-6H        | 11.86        | 22.43        | 28.58   |
| 15         | D                  | 5.16                           | 10.72                          | 36.35  | 21.82  | M22X1-6H        | 14.38        | 25.68        | 33.73   |
| 17         | E                  | 5.94                           | 12.70                          | 36.35  | 23.80  | M25X1-6H        | 16.36        | 28.91        | 35.36   |
| 19         | F                  | 6.73                           | 14.27                          | 36.35  | 25.40  | M28X1-6H        | 17.93        | 32.13        | 36.91   |
| 21         | G                  | 7.54                           | 15.88                          | 37.90  | 26.97  | M31X1-6H        | 19.53        | 35.38        | 40.87   |
| 23         | H                  | 8.83                           | 17.86                          | 37.90  | 28.98  | M34X1-6H        | 21.51        | 37.80        | 42.06   |
| 25         | J                  | 9.12                           | 19.43                          | 37.90  | 30.56  | M37X1-6H        | 23.09        | 41.05        | 43.66   |

All dimensions for reference only.

# Tri-Start – accessories

## universal “header assembly” for flex print or PC board mounting

### Mounts to all MIL-DTL-38999 and MIL-C-26482 Connectors

The use of connectors with printed circuit termination is rapidly gaining popularity due to the rise of high volume, vapor phase or wave solder manufacturing processes. Termination of this style of connector to flex print or a printed circuit board represents a major cost in the manufacturing process for users. When adding flex or printed circuit board assemblies to an expensive filter or filter/transient protection connector, the total cost of a failed solder joint, a bent pin, or an unanticipated electrical failure becomes prohibitive. The universal header assembly from Amphenol will provide for easy separation of the connector from the board on these occasions.



Headers provide easy separation of the connector from the PC board.

### Header Assemblies Provide Cost Savings

Incorporation of the header assembly provides the user with time and cost saving potentials. These header assemblies can be vapor phase or wave soldered to flex or printed circuit boards prior to the receipt of the EMI/EMP connector. Headers can be installed to standard connectors, allowing for electrical testing that would adversely affect the sensitive diodes, MOV's or capacitors in the EMI/EMP connectors. Expensive connector assemblies can be easily removed from and reattached to the header assembly as the manufacturing process dictates.

### Mounting Applications

Shell modifications are recommended, but are not necessary. The header assembly can be attached to connectors with standard flange placement or directly to the circuit board. The ideal application would involve either a single flange moved all the way to the rear of the connector or a double flange. Cinch nuts can be installed in either flange to allow easier mounting to the panel or the header assembly. The forward flange would mount the connector to the panel; the rear flange would be used to mount the header assembly. Various types of captivated or loose attaching screws can be utilized for unique applications.

Amphenol universal headers are slotted to allow mounting to all series of MIL-DTL-38999 or MIL-C-26482 connectors without special alterations. They are of similar dimension as the flange of the mounting connector and would be approximately .185 inches (4.70 mm) thick.

### Incorporates a Shorter Pin/Socket Contact

The heart of the header assembly is a short pin/socket contact. The tail of the contact would accommodate standard through-hole diameters and thickness of the flex or printed circuit board materials. The socket is imbedded in the molded material, making electrical engagement with the printed circuit tail of the connector.

### Cylindrical Configuration

- 3 PCB stickout dimensions are available.
- Size 22 contacts use .175 thick headers
- Size 16 to 20 contacts use .195 thick headers
- Consult Amphenol, Sidney NY for additional configurations.
- Headers for cylindrical connectors accommodate up to 128 pins. Consult Amphenol catalogs for mating connector contact layouts (12-092 and 12-090 for MIL-DTL-38999 and 12-070 for MIL-C-26482)

### Mounting to Rectangular ARINC Connectors

- Headers for ARINC connector arrangements accommodate up to 150 pins
- Consult Amphenol, Sidney, NY for ARINC configurations and detailed dimensions.

### Materials

- Body is molded from Torlon or PPS (Polyphenylene Sulfide)
- Electrical engagement areas of the header contact are plated with .00003 inches minimum of gold over .00005 inches minimum of nickel.

See drawing of standard header on next page.



# Tri-Start – accessories

## universal “header assembly” for flex print or PC board mounting, cont.

The drawing below shows the standard universal adapter for use with MIL-DTL-38999 and MIL-C-26482 connectors. Consult Amphenol Aerospace, Sidney NY for drawings of headers for ARINC configurations.

| Assembly Part Number | Shell Size | F Radius | G ± .005   | S ± .005 | T + .008 - .006 | R1 TP† | R2 TP† | TT + .008 - .006 |
|----------------------|------------|----------|--|----------|-----------------|--------|--------|------------------|
| 21-904008-XX()       | 8/9        | .094     | .175<br>Assemblies containing Size 22 contacts only:<br>Assemblies containing Size 16 or 20 contacts: .195 | .938     | .128            | .719   | .594   | .216             |
| 21-904010-XX()       | 10/11      | .094     |  | 1.031    | .128            | .812   | .719   | .194             |
| 21-904012-XX()       | 12/13      | .094     |  | 1.125    | .128            | .906   | .812   | .194             |
| 21-904014-XX()       | 14/15      | .125     |  | 1.219    | .128            | .969   | .906   | .173             |
| 21-904016-XX()       | 16/17      | .125     |  | 1.312    | .128            | 1.062  | .969   | .194             |
| 21-904018-XX()       | 18/19      | .125     |  | 1.438    | .128            | 1.156  | 1.062  | .194             |
| 21-904020-XX()       | 20/21      | .125     |  | 1.562    | .128            | 1.250  | 1.156  | .194             |
| 21-904022-XX()       | 22/23      | .125     |  | 1.688    | .154            | 1.375  | 1.250  | .242             |
| 21-904024-XX()       | 24/25      | .125     |  | 1.812    | .154            | 1.500  | 1.375  | .242             |

See Suffix Chart

† TP designates true position dimensioning.

NOTE:  
Size 22 accepts .018 to .022 dia. PCB tails.  
Size 16 accepts .048 to .064 dia. PCB tails.  
Size 20 accepts .037 to .043 dia. PCB tails.

### HOW TO ORDER INFORMATION

#### For Universal Adapter Used with MIL-DTL-38999 Connectors

Use coded number as follows:

21-9040 XX - XX X

Designates Amphenol Interface Adapter

Shell size designation for MIL-DTL-38999 Series III. See Suffix chart.

Arrangement number - See MIL-STD-1560 or MIL-STD-1669. See insert availability charts on pages 6 and 7.

Contact PCB Stickout designation See Suffix chart.

Universal adapters are also used with MIL-DTL-38999 Series I and II and with MIL-C-26482, Series 1 and 2. For how to order information on adapters to be used with ARINC connectors, consult Amphenol, Sidney NY.

### ASSEMBLY NUMBER SUFFIX CHART

| Shell Size Designation* | Arrangement Number Suffix***                                | Contact PCB Stickout** |                   |
|-------------------------|---|------------------------|-------------------|
|                         |   | Suffix                 | B ± .015 Stickout |
| 08                      | Insert Arrangement Suffix from MIL-STD-1560 or MIL-STD-1669 | 1                      | .120              |
| 10                      |   | 2                      | .185              |
| 12                      |   | 3                      | .270              |
| 14                      |   |                        |                   |
| 16                      |   |                        |                   |
| 18                      |   |                        |                   |
| 20                      |   |                        |                   |
| 22                      |   |                        |                   |
| 24                      |   |                        |                   |

\*Shell size designation for MIL-DTL-38999 Series I, II, III and IV and MIL-C-26482 Series 1 and 2.

Examples: Shell size 9 use 08. Shell size 25 use 24.

\*\* Size 22 contacts available in all 3 stickout lengths. Size 16 and 20 contacts available only in .185 and .270 lengths.

\*\*\* Insert arrangement 14-97 and 15-97 are not available at this time. Consult Amphenol, Sidney NY for information.

# Tri-Start – accessories

## contacts, sealing plugs, protection caps

### STANDARD 500 CYCLE CONTACTS FOR TV AND CTV, P & S

| Contact Size | TV/CTV Pins     |             | TV/CTV Sockets |             |
|--------------|-----------------|-------------|----------------|-------------|
|              | Military No.    | Supersedes  | Military No.   | Supersedes  |
| 8 (Coax)*    | M39029/60-367   | MS27536     | M39029/59-366  | MS27535     |
| 8 (Power)    | N/A             | N/A         | N/A            | N/A         |
| 8 (Twinax)   | M39029/90-529** | N/A         | M39029/91-530  | N/A         |
| 10 (Power)   | M39029/58-528   | N/A         | M39029/56-527  | N/A         |
| 12           | M39029/58-365   | MS27493-12  | M39029/56-353  | MS27490-12  |
| 16           | M39029/58-364   | MS27493-16  | M39029/56-352  | MS27490-16  |
| 20           | M39029/58-363   | MS27493-20  | M39029/56-351  | MS27490-20  |
| 22D          | M39029/58-360   | MS27493-22D | M39029/56-348  | MS27490-22D |
| 4            | N/A             | N/A         | N/A            | N/A         |
| 0            | N/A             | N/A         | N/A            | N/A         |

Above part numbers include standard 500 cycle finish designation - gold plating over suitable underplate in accordance with MIL-C-39029. For other finish variations, consult Sidney, NY.

\*For use with RG180B/U and RG195A/U cable. For other size 8 coax or optional sizes 12 and 16 coax contacts available for use in Tri-Start connectors, see catalog 12-130 or consult Amphenol, Sidney, NY

\*\* For use with M17/M176-00002 cable.

† Optional design - see slash sheet MS39029.

For other contact options available for use in Tri-Start connectors, (wire wrap, thermocouple, fiber optic) consult Amphenol. Wire wrap data given on next page.

### 1500 CYCLE CONTACTS FOR CTV, CLASSES H & J

| Contact Size | CTV Pins       |                |            | CTV Sockets    |                |            |
|--------------|----------------|----------------|------------|----------------|----------------|------------|
|              | Proprietary No | Military No    | Supersedes | Proprietary No | Military No    | Supersedes |
| 12           | 10-597072-2X   | M39029/107-623 | –          | 10-597073-2X   | M39029/106-617 | –          |
| 16           | 10-597068-2X   | M39029/107-622 | –          | 10-597069-2X   | M39029/106-616 | –          |
| 20           | 10-597064-2X   | M39029/107-621 | –          | 10-597065-2X   | M39029/106-615 | –          |
| 22D          | 10-597058-3X   | M39029/107-620 | –          | 10-597061-2X   | M39029/106-614 | –          |

### PLASTIC PROTECTION CAPS

| Shell Size | Plug        | Receptacle  |
|------------|-------------|-------------|
| 9          | 10-70506-14 | 10-70500-10 |
| 11         | 10-70506-16 | 10-70500-12 |
| 13         | 10-70500-18 | 10-70500-14 |
| 15         | 10-70500-20 | 10-70500-16 |
| 17         | 10-70500-22 | 10-70500-19 |
| 19         | 10-70500-24 | 10-70500-20 |
| 21         | 10-70524-1  | 10-70500-22 |
| 23         | 10-70506-28 | 10-70500-24 |
| 25         | 10-70500-28 | 10-70524-1  |

### MS METAL PROTECTION CAPS

| Shell Size | MS Shell Size Code | MS Plug Protection Cap | MS Receptacle Protection Cap |
|------------|--------------------|------------------------|------------------------------|
| 9          | A                  | D38999/32W9X*          | D38999/33W9X*                |
| 11         | B                  | D38999/32W11X*         | D38999/33W11X*               |
| 13         | C                  | D38999/32W13X*         | D38999/33W13X*               |
| 15         | D                  | D38999/32W15X*         | D38999/33W15X*               |
| 17         | E                  | D38999/32W17X*         | D38999/33W17X*               |
| 19         | F                  | D38999/32W19X*         | D38999/33W19X*               |
| 21         | G                  | D38999/32W21X*         | D38999/33W21X*               |
| 23         | H                  | D38999/32W23X*         | D38999/33W23X*               |
| 25         | J                  | D38999/32W25X*         | D38999/33W25X*               |

### SEALING PLUGS

| Contact Size | Proprietary No. | Military No. |
|--------------|-----------------|--------------|
| 8 (Coax)     | 10-482099-8     | N/A          |
| 8 (Twinax)   | T3-4008-59P     | N/A          |
| 8 (Power)    | 10-405996-81    | MS27488-8-1  |
| 10 (Power)   | 10-576225       | N/A          |
| 12           | 10-405996-121   | MS27488-12-1 |
| 16           | 10-405996-161   | MS27488-16-1 |
| 20           | 10-405996-201   | MS27488-20-1 |
| 22D          | 10-405996-221   | MS27488-22-1 |
| 4            | 10-405996-41    | MS27488-4-1  |
| 0            | 10-405996-01    | MS27488-0-1  |

\* To complete order number, replace X with applicable letter as follows:

R - designates eyelet type

N - designates washer type

MS metal protection caps are supplied with service class W which designates corrosion resistant olive drab cadmium plate aluminum.

Consult Amphenol, Sidney, NY for more detailed information on ordering MS Metal protection caps.

# Tri-Start

## contacts – printed circuit board, wire wrap

### SOCKETS

| PCB Socket Contacts | Size | Tail Dia    | Contact Stickout Max/Min<br>(See Illustration below) |              |                   |              |
|---------------------|------|-------------|--|--------------|-------------------|--------------|
|                     |      |             | D38999/20  |              | D38999/26         |              |
|                     |      |             | TVP00  | TV06         | D38999/24<br>TV07 |              |
|                     |      |             |  | Metal        | Composite         |              |
| 10-497623-15        | 22D  | .019        | .291<br>.226   | .316<br>.251 | .285<br>.222      | .242<br>.182 |
| 10-497623-25        | 22D  | .019        | .868<br>.803   | .893<br>.828 | .862<br>.802      | .819<br>.759 |
| 10-497623-35        | 22D  | .019        | .348<br>.283   | .373<br>.308 | .342<br>.282      | .299<br>.239 |
| 10-497623-45        | 22D  | .019        | .208<br>.143   | .233<br>.168 | .202<br>.142      | .159<br>.099 |
| 10-497623-75        | 22D  | .019        | .146<br>.081   | .171<br>.106 | .140<br>.080      | .097<br>.037 |
| 10-497623-105       | 22D  | .019        | .028<br>NS   | .053<br>.000 | .022<br>NS        | .021<br>NS   |
| 10-497623-145       | 22D  | .019        | .609<br>.539   | .634<br>.564 | .603<br>.538      | .560<br>.495 |
| 10-497623-155       | 22D  | .019        | .423<br>.358   | .448<br>.383 | .417<br>.357      | .374<br>.314 |
| 10-497643-15        | 20   | .019        | .348<br>.294   | .373<br>.319 | .342<br>.293      | .299<br>.250 |
| 10-497643-25        | 20   | .019        | .213<br>.159   | .238<br>.184 | .207<br>.158      | .164<br>.115 |
| 10-497643-35        | 20   | .019        | .555<br>.501   | .580<br>.526 | .549<br>.500      | .506<br>.457 |
| 10-497643-45        | 20   | .019        | .138<br>.084   | .163<br>.109 | .132<br>.083      | .089<br>.040 |
| 10-497650-15        | 16   | .040        | .255<br>.201   | .280<br>.226 | .249<br>.200      | .206<br>.157 |
| Wire Wrap Contacts  |      | Tail Square |  |              |                   |              |
| 10-497577-15        | 22D  | .025        | .155<br>.090   | .180<br>.115 | .149<br>.089      | .106<br>.046 |
| 10-497577-25        | 22D  | .025        | .002<br>NS   | .027<br>NS   | NS<br>NS          | NS<br>NS     |
| 10-897577-35        | 22D  | .025        | .201<br>.136   | .226<br>.161 | .195<br>.135      | .152<br>.092 |
| 10-497577-55        | 22D  | .025        | .566<br>.501   | .591<br>.526 | .560<br>.500      | .517<br>.457 |
| 10-497621-15        | 20   | .025        | .151<br>.101   | .176<br>.126 | .145<br>.100      | .102<br>.057 |
| 10-497621-25        | 20   | .025        | .605<br>.555   | .630<br>.580 | .599<br>.554      | .556<br>.511 |
| 10-497621-35        | 20   | .025        | .308<br>.258   | .333<br>.283 | .302<br>.257      | .259<br>.214 |

### PINS

| PCB Pin Contacts   | Size | Tail Dia    | Contact Stickout Max/Min<br>(See Illustration below) |              |                   |              |
|--------------------|------|-------------|--|--------------|-------------------|--------------|
|                    |      |             | D38999/20  |              | D38999/26         |              |
|                    |      |             | TVP00  | TV06         | D38999/24<br>TV07 |              |
|                    |      |             |  | Metal        | Composite         |              |
| 10-407552-15       | 22M  | .019        | .335<br>.280   | .360<br>.305 | .329<br>.279      | .286<br>.236 |
| 10-407552-55       | 22M  | .019        | .224<br>.169   | .249<br>.194 | .218<br>.168      | .175<br>.125 |
| 10-407552-85       | 22M  | .019        | .060<br>.010   | .085<br>.035 | .054<br>.009      | .011<br>NS   |
| 10-407552-95       | 22M  | .019        | NS   | NS           | NS                | NS           |
| 10-407552-115      | 22M  | .019        | .002<br>NS   | .023<br>NS   | NS                | NS           |
| 10-497640-15       | 20   | .019        | .348<br>.298   | .373<br>.323 | .342<br>.297      | .299<br>.254 |
| 10-497640-25       | 20   | .019        | .213<br>.163   | .238<br>.188 | .207<br>.162      | .164<br>.119 |
| 10-497640-45       | 20   | .019        | NS   | NS           | NS                | NS           |
| 10-497640-65       | 20   | .019        | .138<br>.088   | .163<br>.113 | .132<br>.087      | .089<br>.044 |
| 10-497596-15       | 20   | .025        | .058<br>.012   | .083<br>.037 | .052<br>.011      | .009<br>NS   |
| 10-497596-25       | 20   | .025        | .148<br>.102   | .173<br>.127 | .142<br>.101      | .099<br>.058 |
| 10-497596-35       | 20   | .025        | .229<br>.183   | .254<br>.208 | .223<br>.182      | .180<br>.139 |
| 10-497596-55       | 20   | .025        | .346<br>.300   | .371<br>.325 | .340<br>.299      | .297<br>.256 |
| 10-497695-15       | 16   | .040        | .255<br>.205   | .280<br>.230 | .249<br>.204      | .206<br>.161 |
| 10-497630-25       | 16   | .062        | .348<br>.298   | .373<br>.323 | .342<br>.297      | .299<br>.254 |
| 10-497630-35       | 16   | .062        | .060<br>.010   | .085<br>.035 | .054<br>.009      | .011<br>NS   |
| 10-497630-45       | 16   | .062        | .108<br>.062   | .133<br>.087 | .102<br>.061      | .059<br>.018 |
| 10-597502-15       | 12   | .081        | .228<br>.178   | .252<br>.203 | .222<br>.177      | .179<br>.134 |
| Wire Wrap Contacts |      | Tail Square |  |              |                   |              |
| 10-407572-15       | 22D  | .025        | .014<br>NS   | .498<br>.007 | .008<br>NS        | NS<br>NS     |
| 10-407572-35       | 22D  | .025        | .155<br>.105   | .180<br>.130 | .149<br>.104      | .106<br>.061 |
| 10-407572-45       | 22D  | .025        | .255<br>.205   | .280<br>.230 | .249<br>.204      | .206<br>.161 |
| 10-407572-75       | 22D  | .025        | .521<br>.475   | .546<br>.500 | .515<br>.474      | .472<br>.431 |
| 10-407584-25       | 20   | .025        | .605<br>.559   | .630<br>.584 | .599<br>.558      | .556<br>.515 |
| 10-407584-35       | 20   | .025        | .308<br>.262   | .333<br>.287 | .302<br>.261      | .259<br>.218 |

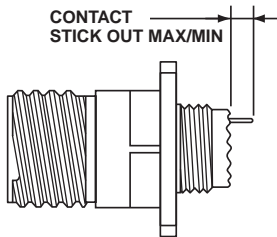

All dimensions for reference only.  
Consult Sidney, NY for specific contact  
contour stickout data.  
NS designates No Stickout.

See also catalog 12-170, Amphenol  
Cylindrical Connectors for PCB  
Applications. This catalog provides the  
most commonly used insert pattern  
pin-out drawings which have been  
tooled for the purpose of attaching  
cylindrical connectors to printed circuit  
boards.

PCB Socket and pin part numbers include finish designation - gold plating over  
suitable underplate in accordance with MIL-C-39029. For other finish variations,  
consult Amphenol, Sidney, NY.  
Note: 22M and 22D contacts are interchangeable.  
For other contact options available for use in Tri-Start connectors (thermocouple,  
fiber optic), consult Amphenol, Sidney, NY.

# Tri-Start application tools

The following data includes information pertaining to the application tools which have been established for crimping, inserting, and removing contacts incorporated in the TV, CTV and MIL-DTL-38999 Series III connectors. For additional information on coax, twinax and triax contact tools see catalog 12-130.

All crimping tools included are the "full cycling" type and when

used as specified in the installation instructions (L-624 and L-844) covering the TV, CTV and MS series connectors, will provide reliable crimped wire to contact terminations. There is a possibility of additional crimping tools other than those included being available at present or in the future for this specific application.

## CRIMPING TOOLS

| Contact Size/Type                        | Crimping Tool                             | Turret Die or Positioner                  |
|--|---|---|
| 12 Pin and Socket                        | M22520/1-01                               | M22520/1-04                               |
| 16 Pin and Socket                        | M22520/1-01<br>M22520/7-01                | M22520/1-04<br>M22520/7-04                |
| 20 Pin and Socket                        | M22520/1-01<br>M22520/2-01<br>M22520/7-01 | M22520/1-04<br>M22520/2-10<br>M22520/7-08 |
| 22D Pin                                  | M22520/2-01<br>M22520/7-01                | M22520/2-09<br>M22520/7-07                |
| 22D Socket                               | M22520/2-01<br>M22520/7-01                | M22520/2-07<br>M22520/7-05                |
| 8 Twinax Center Pin and Socket           | M22520/2-01                               | M22520/2-37                               |
| 8 Twinax Intermediate Outer Pin & Socket | M22520/5-01                               | M22520/5-200                              |

Where 2 or 3 tools are listed for a contact size, only one tool and its die or positioner are required to crimp the contact.

The above crimping tools and positioners are available from the approved tool manufacturer.

| Contact Size/Type               | Crimping Tool | Turret Die or Positioner   |
|---------------------------------|---------------|----------------------------|
| 8 Coaxial Inner Pin and Socket  | M22520/2-01   | M22520/2-31                |
| 8 Coaxial Outer Pin and Socket  | M22520/5-01   | M22520/5-05 Die Closure B  |
|                                 | M22520/5-01   | M22520/5-41 Die Closure B  |
|                                 | M22520/10-01  | M22520/10-07 Die Closure B |
| 16 Coaxial Inner Pin and Socket | M22520/2-01   | M22520/2-35                |
| 16 Coaxial Outer Pin and Socket | M22520/4-01   | M22520/4-02                |
| 12 Coaxial Inner Pin and Socket | M22520/2-01   | M22520/2-34                |
| 12 Coaxial Outer Pin and Socket | M22520/31-01  | M22520/31-02               |
| 10 (Power)                      | TP201423      | 1716P-1                    |

## INSERTION TOOLS

| Use with Contact Size | Plastic Tools  |                  | Metal Tools    |                         |                                       |        |
|-----------------------|----------------|------------------|----------------|-------------------------|---------------------------------------|--------|
|                       | MS Part Number | Color            | Angle Type     |                         | Straight Type Proprietary Part Number | Color  |
|                       |                |                  | MS Part Number | Proprietary Part Number |                                       |        |
| 10 (Power)            | M81969/14-05*  | Gray / (White)   | M81969/8-11    | †                       | †                                     | Green  |
| 12                    | M81969/14-04*  | Yellow / (White) | M81969/8-09    | 11-8674-12              | 11-8794-12                            | Yellow |
| 16                    | M81969/14-03*  | Blue / (White)   | M81969/8-07    | 11-8674-16              | 11-8794-16                            | Blue   |
| 20                    | M81969/14-10*  | Red / (Orange)   | M81969/8-05    | 11-8674-20              | 11-8794-20                            | Red    |
| 22D                   | M81969/14-01*  | Green / (White)  | M81969/8-01    | 11-8674-24              | 11-8794-24                            | Black  |
| 8 Coaxial             | None Required  |                  |                |                         |                                       |        |
| 8 Twinax              | None           |                  | M81969/46-06** | None                    |                                       | Red    |

## REMOVAL TOOLS

| Use with Contact Size | Plastic Tools  |                  | For Unwired Contacts Proprietary Part Number | Metal Tools    |                         |                                       |                |
|-----------------------|----------------|------------------|--|----------------|-------------------------|---------------------------------------|----------------|
|                       | MS Part Number | Color            |  | Angle Type     |                         | Straight Type Proprietary Part Number | Color          |
|                       |                |                  |  | MS Part Number | Proprietary Part Number |                                       |                |
| 10 (Power)            | M81969/14-05*  | (Gray) / White   | †  | M81969/8-12    | †                       | †                                     | Green / White  |
| 12                    | M81969/14-04*  | (Yellow) / White | 11-10050-11                                  | M81969/8-10    | 11-8675-12              | 11-8795-12                            | Yellow / White |
| 16                    | M81969/14-03*  | (Blue) / White   | 11-10050-10                                  | M81969/8-08    | 11-8675-16              | 11-8795-16                            | Blue / White   |
| 20                    | M81969/14-10*  | (Orange) / Red   | 11-10050-9                                   | M81969/8-06    | 11-8675-20              | 11-8795-20                            | Red / Orange   |
| 22D                   | M81969/14-01*  | (Green) / White  | 11-10050-7                                   | M81969/8-02    | 11-8675-24              | 11-8795-24                            | Green / White  |
| 8 Coaxial             | M81969/14-12   | Green            | None   | None           | 11-9170                 | DRK264-8††                            | N/A            |
| 8 Twinax              | M81969/14-12   | Green            | None   | M81969/46-12** | 11-9170                 | N/A                                   | N/A            |

The M81969/8, 11-8674, 11-8675, and 11-8794 metal contact insertion and removal tools will accommodate wires having the maximum outside diameter as follows: Contact size 12: dia. is .155, size 16: dia. is .109, size 20: dia. is .077, size 22D: dia. is .050. When wire diameters exceed those specified, the plastic tools must be used.

\* Double end insertion/removal tool.

\*\* Twinax insertion tools are available only in a straight type, metal version.

† To be determined.

†† Contact Daniels Manufacturing Co. for availability.

# Tri-Start

## how to order – (Amphenol® TV, metal)

## how to order – (Amphenol® TV26 CLUTCH-LOK®)

### Proprietary Part Number

Amphenol® Tri-Start Connectors (metal) can be ordered by coded part number. Ordering procedure is illustrated by part number TVPS00RF-9-35PB( ) as shown below:

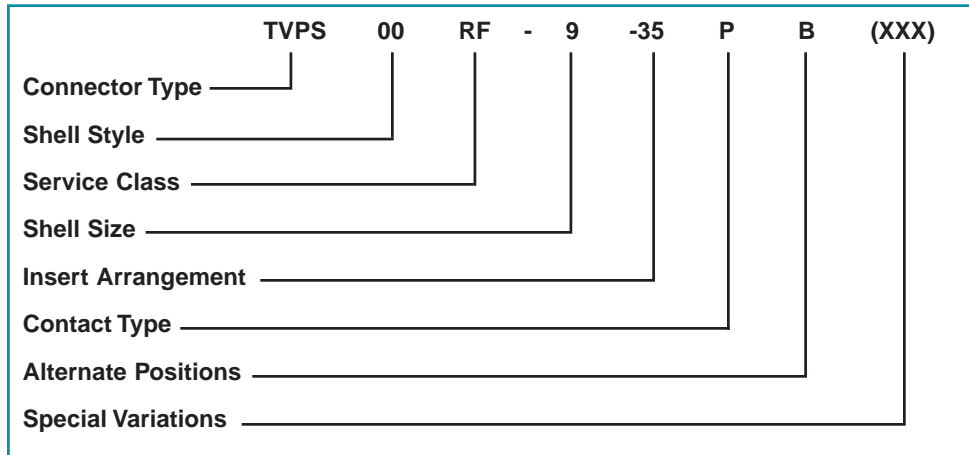

### Connector Type

- TV designates Tri-Start Series Connector
- TVP designates back panel mounted receptacle
- TVS designates 200°C rated
- TVPS designates back panel mounted, 200°C rated receptacle
- MTV designates CLUTCH-LOK connector with “MS” stamping (Note: remove dashes in how to order part number when ordering CLUTCH-LOK)

### Shell Style

- 00 designates wall mount receptacle
- 01 designates line receptacle
- 02 designates box mount receptacle
- 06 designates straight plug
- 26 designates proprietary CLUTCH-LOK high vibration straight plug (available in service classes RK and RS only)
- 07 designates jam nut receptacle
- 09 designates flange mounted plug
- IY designates solder mounted receptacle, hermetic only
- HIY designates weld mounted receptacle, hermetic only

### Service Class

- RX alternate finish, requires special variation suffix. Example: non-conductive, anodic coated aluminum is defined by variation suffix 005. Consult Amphenol, Sidney NY for details, options and availability of non-cadmium or nickel finishes.
- RF electroless nickel plated aluminum, optimum EMI shielding effectiveness –65dB @ 10GHz specification min., 48 hour salt spray, 200°C
- RGF\*\* electroless nickel plated ground plane aluminum, 200°C
- RGW\*\* olive drab cadmium plated ground plane aluminum, 175°C
- RK\* corrosion resistant stainless steel, firewall capability, plus 500 hour salt spray resistance, EMI –45 dB @ GHz specification min., 200°C
- RW corrosion resistant olive drab cadmium plate aluminum, 500 hour extended salt spray, EMI –50 dB @ 10 GHz specification min., 175°C

- RQF same as RF except with Quadrax contacts
- RGQF same as RGF except with Quadrax contacts
- RGQW same as RGW except with Quadrax contacts
- RQK same as RK except with Quadrax contacts and not firewall capable
- RQW same as RW except with Quadrax contacts
- Y hermetic seal, passivated stainless steel, 200°C
- RS\* (non-hermetic connectors), nickel plated stainless steel, optimum EMI shielding effectiveness –65dB @ 10 GHz specification min., 500 hour salt spray, 200°C, firewall barrier
- YN (hermetic connectors), nickel plated stainless steel, 200°C
- DN Durmalon plated, Nickel-PTFE alternative to Cadmium. Corrosion resistant, 1,000 hour salt spray, EMI- 50dB at 10GHz specification min., 175 degrees

### Shell Size

MIL-DTL-38999, Sizes 9-25.

| A | B  | C  | D  | E  | F  | G  | H  | J  | MIL Shell Size      |
|---|----|----|----|----|----|----|----|----|---------------------|
| 9 | 11 | 13 | 15 | 17 | 19 | 21 | 23 | 25 | Amphenol Shell Size |

### Insert Arrangement

MIL-DTL-38999, see insert arrangement charts, pgs. 6 & 7.

### Contact Type

- P designates pin contacts
- S designates socket contacts

### Alternate Positions

Locksmith keying - rotation of minor keys. See page 8. “N” not required for normal position.

### Special Variations

Consult Amphenol Aerospace, Sidney, NY for variations.

\* Coaxial arrangements are not available in these classes.  
 \*\* For more information on Coax/Triax/Twinax Ground Plane Connectors see page 49.

# Tri-Start

how to order – (D38999, TV military, metal)

how to order – (MTV26 CLUTCH-LOK®)

## Military Part Number

To more easily illustrate ordering procedure of Tri-Start Connectors (metal) by military designation, part number D38999/20F A 35 P B is shown as follows:

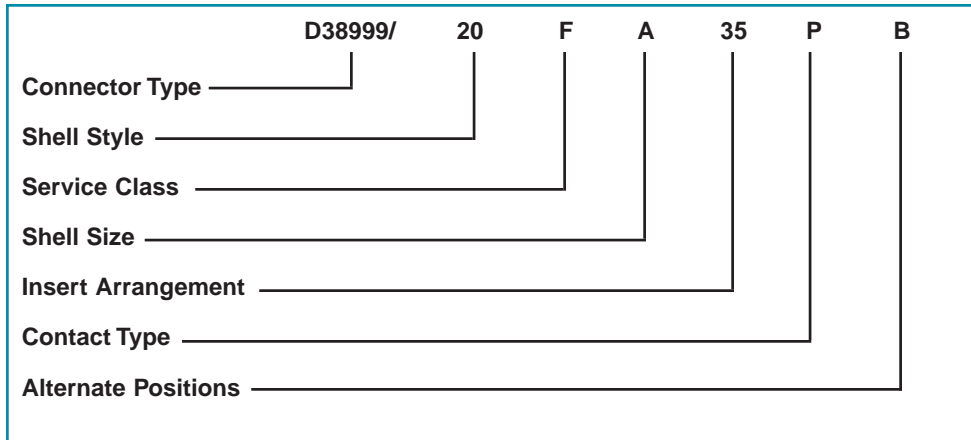

### Connector Type

D38999/ designates MIL-DTL-38999 Series III Connector  
 MTV designates military D38999/26 CLUTCH-LOK high vibration straight plug (available in service class RK only)

### Shell Style

- 20 designates wall mount receptacle
- 21 designates box mount receptacle, hermetic
- 23 designates jam nut receptacle, hermetic
- 24 designates jam nut receptacle
- 25 designates solder mount receptacle, hermetic
- 26 designates straight plug
- 27 designates weld mount receptacle, hermetic

Lanyard Release Connectors (See pages 28-32 for ordering)

- 29 designates lanyard release plug with pin contacts
- 30 designates lanyard release plug with socket contacts
- 31 designates lanyard release plug for MIL-STD-1760 with pin contacts

Protection Caps (See page 40 for ordering MS protection caps)

- 32 designates plug protection cap
- 33 designates receptacle protection cap

### Service Class

- C non-conductive, anodic coated aluminum, 500 hour salt spray, 200°C
- F electroless nickel plated aluminum, optimum EMI shielding effectiveness –65dB @ 10GHz specification min., 48 hour salt spray, 200°C
- G space grade, electroless nickel, 48 hour salt spray, 200°C
- K corrosion resistant stainless steel, firewall capability, plus 500 hour salt spray resistance, EMI –45 dB @ GHz specification min., 200°C
- L corrosion resistant steel, electrodeposited nickel, 48 hour salt spray, 200°C

- W corrosion resistant olive drab cadmium plate aluminum, 500 hour extended salt spray, EMI –50 dB @ 10 GHz specification min., 175°C
- Y hermetic seal, passivated stainless steel, 200°C
- S (non-hermetic connectors), nickel plated stainless steel, optimum EMI shielding effectiveness –65dB @ 10 GHz specification min., 500 hour salt spray, 200°C
- N (hermetic connectors), nickel plated stainless steel, 200°C

### Shell Size

MIL-DTL-38999, Sizes 9-25.

| A | B  | C  | D  | E  | F  | G  | H  | J  | MIL Shell Size      |
|---|----|----|----|----|----|----|----|----|---------------------|
| 9 | 11 | 13 | 15 | 17 | 19 | 21 | 23 | 25 | Amphenol Shell Size |

### Insert Arrangement

MIL-DTL-38999, see insert arrangement charts, pgs. 6 & 7.

### Contact Type

- P designates pin contacts
- S designates socket contacts
- A designates same as “P” except supplied less pin contacts
- B designates same as “S” except supplied less socket contacts (A & B designates non-standard contact applications)
- X designates eyelet contacts, hermetics only

### Alternate Positions

Locksmith keying - rotation of minor keys. See page 8.  
 Use N for normal.

### Special Variations

Consult Amphenol Aerospace, Sidney, NY for variations.

# Tri-Start

## how to order – (Amphenol® CTV, composite)

### Proprietary Part Number

Amphenol® Tri-Start Composite Connectors can be ordered by coded part number. Ordering procedure is illustrated by part number CTVPS00RF-9-35P B as shown below:

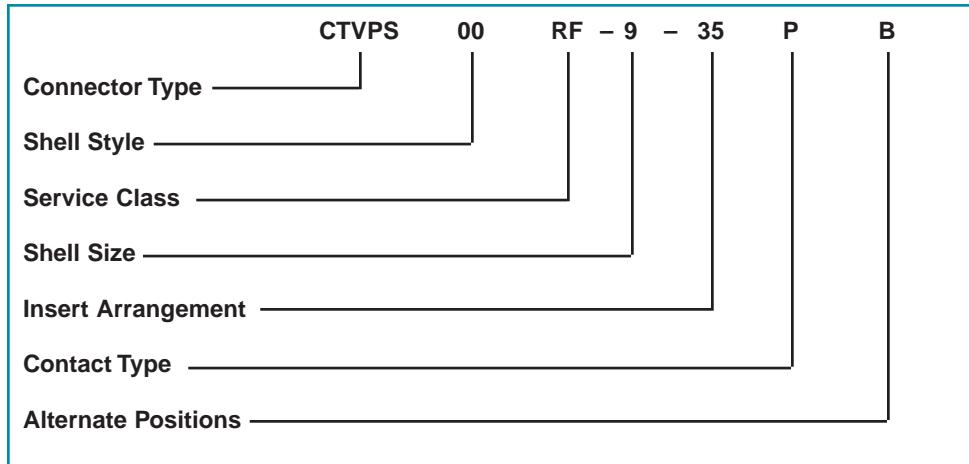

#### Connector Type

CTV designates Tri-Start Series Connector  
CTVP designates panel mounted receptacle  
CTVS designates 200°C rated  
CTVPS designates panel mounted, 200°C rated receptacle

#### Shell Style

00 designates wall mount receptacle  
01 designates line receptacle  
02 designates box mount receptacle\*  
06 designates straight plug  
07 designates jam nut receptacle

#### Service Class

RF electroless nickel plated composite, 200°C, 2000 hour salt spray  
RW olive drab cadmium plated composite, 175°C  
RGF\*\* electroless nickel plated ground plane composite, 200°C  
RGW\*\* olive drab cadmium plated ground plane composite, 175°C  
RQF same as RF composite except with Quadrax contacts  
RQW same as RW composite except with Quadrax contacts  
RGQF same as RGF composite except with Quadrax contacts  
RGQW same as RGW composite except with Quadrax contacts  
DN Durmalon plated, Nickel-PTFE alternative to Cadmium. Corrosion resistant, 1,000 hour salt spray, EMI- 50dB at 10GHz specification min., 175 degrees

\* Consult Amphenol Aerospace, Sidney, NY for availability.

\*\* For more information on Coax/Triax/Twinax Ground Plane Connectors see page 49.

#### Shell Size

9 thru 25 available

#### Insert Arrangement

MIL-DTL-38999, see insert arrangement charts, pgs. 6 & 7.

#### Contact Type

H designates 1500 cycle pin contacts  
J designates 1500 cycle socket contacts  
P designates 500 cycle pin contacts  
S designates 500 cycle socket contacts

#### Alternate Positions

Locksmith keying - rotation of minor keys. "N" not required for normal position, see page 8.

# Tri-Start

## how to order – (D38999, CTV military, composite)

### Military Part Number

To more easily illustrate ordering procedure of Tri-Start Composite Connectors by military designation, part number D38999/20JG35PN is shown as follows:



#### Connector Type

D38999/ designates MIL-DTL-38999 Series III Connector

#### Shell Style

20 designates wall mount receptacle  
 24 designates jam nut receptacle  
 26 designates straight plug  
 (Consult Amphenol Aerospace for availability of composite box mount receptacles)

#### Service Class

J olive drab cadmium plate (175°C),  
 2000 hrs. dynamic salt spray  
 M electroless nickel plate (200°C),  
 2000 hrs. dynamic salt spray

#### Shell Size

MIL-DTL-38999, Sizes 9-25

| A | B  | C  | D  | E  | F  | G  | H  | J  | MIL Shell Size      |
|---|----|----|----|----|----|----|----|----|---------------------|
| 9 | 11 | 13 | 15 | 17 | 19 | 21 | 23 | 25 | Amphenol Shell Size |

#### Insert Arrangement

MIL-DTL-38999, see insert arrangement charts, pg. 6 & 7.

#### Contact Type

H designates 1500 cycle pin contacts  
 J designates 1500 cycle socket contacts  
 P designates 500 cycle pin contacts  
 S designates 500 cycle socket contacts  
 A designates same as "P" except supplied less pin contacts  
 B designates same as "S" except supplied less socket contacts  
 (A & B designate non-standard contact applications)

#### Alternate Positions

Locksmith keying - rotation of minor keys. See page 8.  
 (Use N for normal)



# Tri-Start

## weight comparisons (composite vs. metal)

Depending on the shell style, shell size and contact count, weight savings can range from 17% to 40% compared to standard aluminum product.

### Tri-Start Weight in ounces (includes contacts)

| Size/<br>Arrangement | Wall Mount Receptacle (00) |        |          |        |           |        | Jam Nut Receptacle (07) |        |          |        |           |        | Plug (06)       |        |          |        |           |        |
|----------------------|----------------------------|--------|----------|--------|-----------|--------|-------------------------|--------|----------|--------|-----------|--------|-----------------|--------|----------|--------|-----------|--------|
|                      | Stainless Steel            |        | Aluminum |        | Composite |        | Stainless Steel         |        | Aluminum |        | Composite |        | Stainless Steel |        | Aluminum |        | Composite |        |
|                      | Pin                        | Socket | Pin      | Socket | Pin       | Socket | Pin                     | Socket | Pin      | Socket | Pin       | Socket | Pin             | Socket | Pin      | Socket | Pin       | Socket |
| 9-35                 | .7216                      | .7840  | .3248    | .3777  | .2588     | .3121  | 1.1472                  | 1.2096 | .4416    | .5040  | .3489     | .4413  | 1.0736          | 1.1360 | .4236    | .4625  | .2606     | .2994  |
| 9-98                 | .7216                      | .7776  | .2496    | .3056  | .1664     | .2224  | 1.1472                  | 1.2032 | .4416    | .4976  | .3744     | .4640  | 1.0736          | 1.1296 | .3968    | .4624  | .2991     | .2337  |
| 11-35                | .9488                      | 1.0800 | .3632    | .4960  | .2753     | .4081  | 1.4304                  | 1.5632 | .5936    | .7264  | .4679     | .6007  | 1.2480          | 1.3808 | .5312    | .6389  | .3450     | .4582  |
| 11-98                | .9488                      | 1.0620 | .3632    | .4768  | .2753     | .3889  | 1.4304                  | 1.5440 | .5936    | .7072  | .4679     | .5815  | 1.2480          | 1.3616 | .5330    | .6283  | .3468     | .4457  |
| 13-8                 | 1.2096                     | 1.3888 | .4800    | .6592  | .3696     | .5488  | 1.9104                  | 2.0896 | .7664    | .9456  | .6560     | .8352  | 1.8048          | 1.9840 | .7936    | .9728  | .5237     | .5952  |
| 13-35                | 1.2160                     | 1.4320 | .4864    | .7024  | .3762     | .5922  | 1.9168                  | 2.1328 | .7728    | .9888  | .6136     | .8296  | 1.8112          | 2.0272 | .8000    | .8472  | .5301     | .6531  |
| 13-98                | 1.2160                     | 1.4016 | .4864    | .6720  | .3762     | .5618  | 1.9168                  | 2.1024 | .7728    | .9584  | .6136     | .7992  | 1.8112          | 1.9968 | .7978    | .9856  | .5244     | .7157  |
| 15-5                 | 1.5312                     | 1.7904 | .6352    | .8944  | .5027     | .7619  | 2.3792                  | 2.6384 | .9728    | 1.2320 | .7749     | 1.0341 | 2.2704          | 2.5456 | .9632    | 1.1719 | .6450     | .8467  |
| 15-18                | 1.5456                     | 1.8416 | .7760    | .9456  | .6432     | .8128  | 2.3936                  | 2.6896 | .9872    | 1.2832 | .8544     | 1.1504 | 2.2848          | 2.5808 | .9776    | 1.2736 | .6594     | .8208  |
| 15-35                | 1.5424                     | 1.8768 | .6464    | .9808  | .5139     | .8483  | 2.3904                  | 2.7344 | .9840    | 1.3280 | .7861     | 1.1301 | 2.2816          | 2.6256 | 1.2179   | 1.3184 | .8961     | 1.0002 |
| 17-6                 | 2.1488                     | 2.5904 | .9360    | 1.3776 | .7812     | 1.2228 | 2.9152                  | 3.3568 | 1.2336   | 1.6752 | .9940     | 1.4356 | 2.5008          | 3.1024 | 1.1408   | 1.7424 | .8160     | 1.4176 |
| 17-26                | 2.1344                     | 2.5600 | .9216    | 1.3472 | .7668     | 1.1924 | 2.9008                  | 3.3264 | 1.2192   | 1.6448 | .9796     | 1.4052 | 2.4864          | 2.9120 | 1.1264   | 1.3343 | .8017     | .8062  |
| 17-35                | 2.1360                     | 2.6640 | .9232    | 1.4512 | .7684     | 1.2964 | 2.9024                  | 3.4304 | 1.2208   | 1.7488 | .9812     | 1.5092 | 2.4880          | 3.0160 | 1.1280   | 1.5497 | .8033     | 1.2144 |
| 19-11                | 2.2592                     | 2.6656 | .9696    | 1.4528 | .7925     | 1.2757 | 3.4352                  | 3.9184 | 1.4720   | 1.9552 | 1.2033    | 1.6865 | 2.9808          | 3.4640 | 1.3472   | 1.8304 | .9632     | 1.4464 |
| 19-32                | 2.1888                     | 2.7264 | .9760    | 1.5136 | .7989     | 1.3365 | 3.4416                  | 3.9792 | 1.4784   | 2.0160 | 1.2097    | 1.7473 | 2.9872          | 3.5248 | 1.3536   | 1.8912 | .9696     | 1.5072 |
| 19-35                | 2.1920                     | 2.8432 | .9792    | 1.6304 | .8021     | 1.4533 | 3.4448                  | 4.0960 | 1.4816   | 2.1328 | 1.2129    | 1.8641 | 2.9904          | 3.6416 | 1.3568   | 2.0080 | .9728     | 1.6240 |
| 21-11                | 2.7456                     | 3.4640 | 1.3088   | 2.0272 | 1.1088    | 1.8272 | 3.9712                  | 4.6896 | 1.8128   | 2.5312 | 1.6128    | 2.3312 | 3.4448          | 4.1632 | 1.7344   | 2.5312 | 1.3039    | 1.8710 |
| 21-16                | 2.6784                     | 3.3168 | 1.2416   | 1.8800 | 1.0422    | 1.6806 | 3.9040                  | 4.5424 | 1.7456   | 2.3840 | 1.4505    | 2.0889 | 3.3776          | 4.0160 | 1.6672   | 2.3168 | 1.2352    | 1.8736 |
| 21-35                | 2.6672                     | 3.4992 | 1.2304   | 2.0624 | 1.0310    | 1.8630 | 3.8928                  | 4.7248 | 1.7344   | 2.5664 | 1.4393    | 2.2713 | 3.3664          | 4.1984 | 1.6560   | 2.2309 | 1.2255    | 1.8003 |
| 21-41                | 2.6768                     | 3.3600 | 1.2400   | 1.9232 | 1.0406    | 1.7238 | 3.9024                  | 4.5856 | 1.7440   | 2.4272 | 1.4489    | 2.1321 | 3.3760          | 3.5792 | 1.6656   | 1.8688 | 1.2336    | 1.4368 |
| 23-21                | 3.0352                     | 3.8624 | 1.4496   | 2.2768 | 1.2279    | 2.0551 | 4.2368                  | 5.0640 | 1.9440   | 2.7712 | 1.6368    | 2.4640 | 3.7920          | 4.6192 | 1.9216   | 2.7488 | 1.4637    | 2.2896 |
| 23-35                | 3.0240                     | 4.0448 | 1.4384   | 2.4592 | 1.2167    | 2.2375 | 4.2256                  | 5.2464 | 1.9328   | 2.9536 | 1.6256    | 2.6464 | 3.7808          | 4.8016 | 1.9104   | 2.6087 | 1.4525    | 2.1507 |
| 23-53                | 2.8992                     | 3.9072 | 1.4560   | 2.4816 | 1.2343    | 2.2599 | 4.2432                  | 5.1088 | 1.9504   | 2.8160 | 1.6432    | 2.5088 | 3.7984          | 4.6640 | 1.9280   | 2.7936 | 1.4672    | 2.2384 |
| 25-4                 | 3.4512                     | 4.4800 | 1.7312   | 2.8816 | 1.4864    | 2.1904 | 4.8048                  | 5.8272 | 2.2016   | 3.2480 | 1.9568    | 2.8720 | 4.2224          | 5.2496 | 2.2128   | 3.2560 | 1.7133    | 2.4163 |
| 25-19                | 3.5312                     | 4.7264 | 1.8112   | 3.0064 | 1.5664    | 2.7616 | 4.8848                  | 6.0816 | 2.2816   | 3.4784 | 2.0368    | 3.2336 | 4.3024          | 5.4992 | 2.2928   | 3.4896 | 1.7933    | 2.7058 |
| 25-20                | 3.8190                     | 4.7150 | 2.0173   | 3.1125 | 1.7733    | 2.8512 | 5.1430                  | 6.0380 | 2.4877   | 3.5421 | 2.1872    | 3.2416 | 4.4350          | 5.3300 | 2.2580   | 3.0182 | 1.8288    | 2.8928 |
| 25-35                | 3.4416                     | 4.6656 | 1.7216   | 2.9456 | 1.4776    | 2.7016 | 4.7952                  | 6.0192 | 2.1920   | 3.4160 | 1.8915    | 3.1155 | 4.2128          | 5.4368 | 2.2032   | 3.4272 | 1.7037    | 2.9277 |
| 25-61                | 3.4304                     | 4.4848 | 1.7282   | 2.7648 | 1.4841    | 2.5208 | 4.7840                  | 5.8384 | 2.1808   | 3.2352 | 1.8803    | 2.9347 | 4.2016          | 5.2560 | 2.1920   | 3.2464 | 1.6912    | 2.7456 |

All weight measurements are for reference only.

# Tri-Start – specials

## fiber optics, filter protection, PCB applications

### FIBER OPTIC

Amphenol multi-channel fiber optic connectors offer a precision optic interconnect system within the high performance MIL-DTL-38999 Series III connector. The metal-to-metal feature of the Tri-Start connector provides protection from damage in severe environmental and physical conditions. Optical performance is optimized utilizing the ceramic alignment features employed by the termini. Insertion losses are typically .8dB and can range from .5 to 1.5 dB, depending on test conditions.

Ask for publication 12-352 for complete information on Fiber Optic Connectors.

### TRANSIENT PROTECTION

EMI/EMP protection devices can be integrated into the MIL-DTL-38999 Series III connector to provide a cost effective alternative to discrete devices mounted inside the box. These unique, high performance designs provide weight and space savings necessary for modern electronic systems.

Ask for publication 12-120 for complete information on Amphenol Filter/Transient Protection Connectors.

### FLEX TERMINATION ASSEMBLIES FOR PRINTED CIRCUIT BOARD APPLICATIONS

Amphenol provides flex termination assemblies for printed circuit board attachment through Amphenol ACT, Advanced Circuit Technology. Flex circuits are available for MIL-DTL-38999 connectors in flat or sculptured styles. Sculptured® Flexible Circuits with built-in terminations eliminate the failures associated with crimped or solder-on contacts, and they are designed to geometrically fit the tight space requirements within a unit. They plug into a printed circuit board and create a self-locking terminal pad which eliminates the need for an additional interconnect to the PCB.

### TRI-START CONNECTORS WITH PC TAIL CONTACTS

Printed circuit tail twinax contacts are currently supplied in 8, 12 and 16 coax type, 8, 10 and 12 twinax type, and 8 triax socket type. These provide a cost effective packaging solution for limited space applications where connectors are attached to printed circuit boards.

Ask for catalog 12-170, Amphenol Cylindrical Connectors for PCB Applications and catalog 12-130, Amphenol High Frequency Contacts for Multi-pin Connectors.



Multi-Channel  
Fiber Optic Connectors

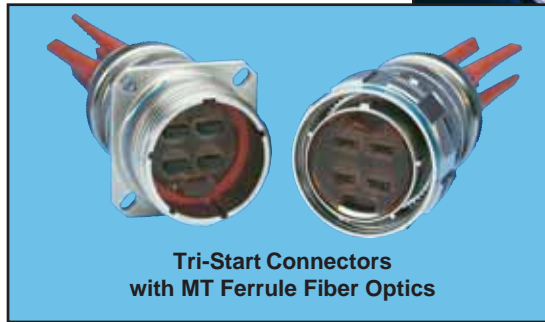

Tri-Start Connectors  
with MT Ferrule Fiber Optics



Filter/Transient Protection Connectors



Flex Termination Assemblies



PC Tail Contacts

# Tri-Start – specials

## coax, twinax and triax contacts, ground plane connectors, press fit connectors

Amphenol MIL-DTL-38999 Series III connectors are the most commonly used connectors for incorporation of shielded contacts along with traditional crimp contacts and also with contacts for data bus, LAN and coax/triax/twinax transmission lines with conductive inserts that ground the outer conductor of the coax, triax, twinax contact to the shell. These connectors are sold “less contacts”. They will accommodate size 8 coax, triax or twinax contacts or size 12 and 16 coax contacts.

The insert availability chart on pages 6 and 7 indicates the patterns that are available in a ground plane version, (see those designated with a star symbol), and consult how to order pages for ordering procedures.

### CONNECTORS WITH SHIELDED COAX CONTACTS

For shielded wire applications, coaxial contacts can be incorporated into MIL-DTL-38999 connectors. Designed-in crimp or solder types are available to fit various RG and special cables. High performance coaxial contacts eliminate discontinuities or impedance variations due to movement of parts under axial load.

### CONNECTORS WITH CONCENTRIC TWINAX CONTACTS

The size 8 concentric twinax contact was developed for use in MIL-STD-1553 Airborne multiplex data bus applications which require high performance interconnect characteristics in multi-pin connectors. Ideal for this application need is the high performance Tri-Start connector with its fully scoop-proof feature of recessed pins. The concentric twinax contact is crimp terminable to twisted-shielded cable.

### SHIELDED TRIAX CONTACTS

Triax contacts have three conductors and are offered in sizes 8, 10 and 12. They provide additional shielding when terminated to triax cable having solid or stranded center conductors. Each of the three conductors of the triax contact is separated by dielectric insulation to isolate ground planes and to improve shielding effectiveness.

High speed data transmission quadrax contacts are now available for use in MIL-DTL-38999 connectors.

### PRESS FIT CONNECTORS

Tri-Start connectors are also designed for the application of solderless mounting to printed circuit boards. The Press Fit connector performances are compatible with Series III



**Concentric Twinax Contacts  
Qualified to M39029/90 and /91**



**Shielded Coax Contacts**



**38999 Series III Connector  
with Twinax Contacts and  
Standard Contacts**



**Ground Plane Connector with Twinax  
Contacts and Insulated Power/Signal  
Contacts**



**MIL-DTL-38999 Series III  
Connectors with Compliant Pin  
Contacts for Solderless Mount-  
ing on Printed Circuit Boards**

Consult the following Amphenol literature for further information:  
Product Data Sheet 139 for Ground Plane Connectors.  
Product Data Sheet 188 for Press Fit Connectors.  
Catalog 12-130 for High Frequency Contacts for Multi-pin Connectors.

# Tri-Start – specials

## quadrax and differential twinax contacts

### SIZE 8 HIGH SPEED QUADRAX AND DIFFERENTIAL TWINAX CONTACTS FOR USE IN MIL-DTL-38999 CONNECTORS

**Quadrax Contacts** consist of an outer contact with four strategically spaced inner contacts forming two 100 or 150 Ohm matched impedance differential pairs.

**Differential Twinax Contacts** consist of an outer contact with two inner contacts spaced to form one 100 or 150 Ohm matched impedance differential pair.

Both contacts can be used in connectors for Ethernet 100 Base-T-100 Ohm, Fibre-Channel-150 Ohm and IEEE 1394B FireWire-110 Ohm applications.

#### TYPICAL ELECTRICAL PERFORMANCE

- Bandwidth: Up to 3 Gigahertz
- Data rate: Exceeding 2 Gbits/sec.
- Voltage rating: 500 Vrms max. @ sea level
- Dielectric withstanding voltage:  
1000 VACrms between all inner contacts @ sea level  
500 VACrms between inner and outer contacts @ sea level

Quadrax contacts are also available in ARINC 600 Rectangular connectors. See photo on right; consult Amphenol Aerospace for further information.

Also available are Quadrax and Twinax Transition Adapters which provide a method of launching from the high speed connectors to PCB boards.

Consult Amphenol Aerospace, Sidney NY for ordering information for MIL-DTL-38999 Series III connectors with quadrax and differential twinax contacts. Below is a chart that provides contact part numbers available, but not limited to, the cables listed. All contacts are available kitted with or installed into specially modified MIL-DTL-38999 connectors. Consult Amphenol for cables not listed.

| CONTACT PART NUMBERS AND APPLICABLE CABLES<br>FOR USE IN D38999 CONNECTORS |             |                                     |                       |
|--|-------------|-------------------------------------|-----------------------|
| Description  | Part Number | Cable Part Number                   | Impedance             |
| Quadrax Socket   | 21-33385-21 | Draka Fileca F-4703-3               | 100 Ohm               |
|  | 21-33385-31 | Tensolite 26473/02006X-4(LD)        | 150 Ohm               |
|  | 21-33385-51 | Tensolite NF24Q100                  | 100 Ohm               |
|  | 21-33385-61 | Tensolite NF22Q100 or Thermax 956-5 | 100 Ohm               |
|  | 21-33385-61 | Tensolite 24450/03089X-4(LD)        | 110 Ohm               |
|  | 21-33385-71 | Tensolite NF26Q100                  | 100 Ohm               |
|  | 21-33385-91 | JSFY02                              | 110 Ohm               |
|  | 21-33397-21 | PCB (1.035 length)                  | 100 Ohm               |
|  | 21-33397-31 | PCB (.866 length)                   | 100 Ohm               |
|  | Quadrax Pin | 21-33384-21                         | Draka Fileca F-4703-3 |
| 21-33384-31  |             | Tensolite 26473/02006X-4(LD)        | 150 Ohm               |
| 21-33384-51  |             | Tensolite NF24Q100                  | 100 Ohm               |
| 21-33384-61  |             | Tensolite NF22Q100 or Thermax 956-5 | 100 Ohm               |
| 21-33384-61  |             | Tensolite 24450/03089X-4(LD)        | 110 Ohm               |
| 21-33384-71  |             | Tensolite NF26Q100                  | 100 Ohm               |
| 21-33384-91  |             | JSFY02                              | 110 Ohm               |
| 21-33398-21  |             | PCB (1.035 length)                  | 100 Ohm               |
| 21-33398-31  |             | PCB (.866 length)                   | 100 Ohm               |
| 21-33425-1   |             | Right Angle Special                 | 100 Ohm               |
| Differential Twinax Socket   | 21-33388-21 | Tensolite 24463/9P025X-2(LD)        | 100 Ohm               |
|  | 21-33388-31 | Tensolite 26483/03071X-2(LD)        | 100 Ohm               |
|  | 21-33835-1  | PCB (1.035 length)                  |                       |
| Differential Twinax Pin  | 21-33387-21 | Tensolite 24463/9P025X-2(LD)        | 100 Ohm               |
|  | 21-33387-31 | Tensolite 26483/03071X-2(LD)        | 100 Ohm               |
|  | 21-33834-1  | PCB (1.035 length)                  |                       |



**D38999 Series III Groundplane Connector with Quadrax PCB Sockets Installed**  
Contacts front are Differential Twinax (left) and Quadrax (right)



**Quadrax Contact for use in ARINC 600 Connectors**

# Tri-Start – specials

deep reach and stand-off shells, connectors with integral strain reliefs, ESD protection, RJ Field

## OTHER SPECIALS WITHIN THE TRI-START FAMILY OF CONNECTORS:

- **Deep Reach Shells** – for increased panel thicknesses.
- **Stand-off Flange Shells** – for attachment to printed circuit boards
- **Connectors with Integral Strain Reliefs** – cost savings through integration of strain relief to the shell.
- **Electrostatic Discharge (ESD) Protection** – Amphenol has developed a design feature for the Tri-Start connector which will protect sensitive components from Electrostatic Discharge without diodes, varistors, gas tubes, or “experimental” semiconductive materials. These connectors utilize the Faraday Cage principal to shunt electrostatic discharge events to the conductive enclosure on which the connector is mounted, thus never allowing the high voltage, high current discharge event to reside on any contacts. The ESD protected connectors have the same physical envelope as their standard counterparts, and do not require special mounting or terminating techniques. All of the contacts remain fully functional, and electrical characteristics such as capacitance are not effected. For more information on ESD protected connectors, ask for Product Data Sheet 171. Also publication L-2075, “ESD Attenuation Test Procedure for Connectors with Faraday Cage Protective Structures” is available as a reference document.



Tri-Start with Integral Strain Relief



Tri-Start Jam Nut Receptacle with Deep Reach Shell



Electrostatic Discharge (ESD) Testing on Tri-Start Filter Connector



Tri-Start with Stand-off Flange

## RJ FIELD CONNECTORS

Amphenol Socapex offers the RJF TV within the MIL-DTL-38999 connector shell for Ethernet connection. The RJ Field is designed for use where it is necessary to go beyond the protected office environment of most Ethernet applications, to the harsher environments of industrial and even mil-aero applications. Allows use of Ethernet Class D/Cat. 5e connection for 10 BaseT, 100 BaseTX, or 1000 Base T networks. Consult Amphenol Socapex for further information.



RJF TV Connectors for Ethernet Connection

**Amphenol Corporation**  
**Amphenol Aerospace**  
**Amphenol Industrial Operations**

40-60 Delaware Avenue  
Sidney, NY 13838-1395  
Phone: 607-563-5011  
1-800-678-0141  
Fax: 607-563-5157  
www.amphenol-aerospace.com  
www.amphenol-industrial.com

**SALES OFFICES**

**Amphenol Corporation**  
**Amphenol Aerospace**

23276 South Pointe Drive  
Suite 113  
Laguna Hills, CA 92653  
Phone: 949-855-4454  
1-800-678-0141  
Fax: 949-855-9115

**Amphenol Corporation**  
**Amphenol Aerospace**

2010 Corporate Ridge  
McLean, VA 22101  
Phone: 1-800-678-0141

**Amphenol Pcd**

2 Technology Drive  
Peabody, MA 01960  
Phone: 978-532-8800  
Fax: 978-532-6800  
Web: www.amphenolpcd.com

**Amphenol Backplane Systems**

18 Celina Avenue  
Nashua, NH 03063  
Phone: 888-318-3553  
Fax: 603-883-0247  
www.amphenol.abs.com

**Amphenol Advance Circuit**  
**Technology**

118 Northeastern Boulevard  
Nashua, NH 03062  
Phone: 603-880-6000  
Fax: 603-880-1785  
Web: www.act.flexcircuit.com

**Amphenol Canada**

20 Melford Drive  
Scarborough, ON M1B 2X6 Canada  
Phone: 416-291-4401  
Fax: 416-292-0647  
Web: www.amphenolcanada.com

**DISTRIBUTORS**

**Corporate Headquarters**  
**ARROW ELECTRONICS**  
7459 S. Lima Street  
Englewood, CO 80112-5816  
Phone: 800-777-2776  
Fax: 800-562-3542  
Web: www.arrow.com

**AVNET**

2211 47th Street  
Phoenix, AZ 85034  
Phone: 800-332-8638  
Web: www.avnet.com

**PEI GENESIS**

2180 Hornig Road  
Philadelphia, PA 19116  
Phone: 800-523-0727  
Fax: 215-552-8022  
Web: www.peigenesis.com

**POWELL ELECTRONICS**

200 Commodore Drive  
Logan Township, NJ 08085  
Phone: 800-235-7880  
Fax: 215-937-4655  
Web: www.powell.com

**TTI INC.**

2441 Northeast Pkwy.  
Fort Worth, TX 76106  
Phone: 800-225-5884  
Fax: 817-740-9494  
Web: www.ttiinc.com

**SMALL DISADVANTAGED/  
MINORITY DISTRIBUTORS**

**CHEROKEE NATION DISTRIBUTORS**

Highway 51 West  
P.O. Box 1130  
Stilwell, OK 74960  
Phone: 918-696-2777  
Fax: 918-696-3129  
Web: www.cnicnd.com

**JRH ELECTRONICS INC.**

2002 E. Lincoln Drive West  
Route 73, P.O. Box 264  
Marlton, NJ 08053  
Phone: 800-467-9309  
Fax: 609-988-8728  
Web: www.jrhelec.com

**INTERNATIONAL**

**Latin America**

**ARGENTINA**

**Amphenol Argentina**  
Avenida Callao 930  
2nd floor Office B Plaza  
C1023AAP Buenos Aires, Argentina  
Phone: (54 11) 48 15 68 86  
Fax: (54 11) 48 14 57 79  
E-mail: vendas@amphenol.com.ar

**BRAZIL**

**Amphenol do Brasil Ltda.**  
Rua Diogo Moreira 132  
CEP 05423-010  
Sao Paulo - SP, Brazil  
Phone: (55-11) 3815.1003  
Fax: (55-11) 3815.1629  
E-mail: vendas@amphenol.com.br

**MEXICO**

**Amphenol Mexico**  
Prolongacion Reforma 61-6 B2  
Col. Paseo de las Lomas  
C.P. 01330 Mexico D.F., Mexico  
Phone: (52-55) 5258.9984  
Fax: (52-55) 5081.6890  
E-mail: info@amphenolmexico.com

**Europe**

**ENGLAND**

**Amphenol Limited**  
Thanet Way, Whitstable  
Kent CT5 3JF, United Kingdom  
Phone: (44-1-227) 773200  
Fax: (44-1-227) 276571  
E-mail: info@amphenol.co.uk

**FRANCE**

**Amphenol Socapex**  
Promenade de l'Arve, BP29  
Thyez 74311 948 Cedex, France  
Phone: (33-4) 50892800  
Fax: (33-4) 50961941  
Web: www.amphenol-socapex.com

**GERMANY**

**Amphenol-Tuchel Elect. GmbH**  
August-Haeusser Strasse 10  
Postfach 1110  
74001 Heilbronn, Germany  
Phone: (49-7131) 929 0  
Fax: (49-7131) 929 414

**GERMANY**

**Amphenol-Air LB GmbH**  
Am Kleinbahnhof 4  
D-66740 Saarlouis, Germany  
Phone: (49-6831) 9810-87  
Fax: (49-6831) 9810-30  
Web: www.amphenol-airlb.com

**ITALY & REST OF EUROPE**

**Amphenol Italia S.p.A.**  
Via Barbaiana 5  
20020 Lainate (Milano), Italy  
Phone: 39-02-932541  
Fax: 39-02-93254444  
E-mail: info@amphenol-it.com

**Middle East / Africa**

**ISRAEL**

**Bar-Tec Ltd.**  
3 Hagavish St., P.O.B. 279  
Kfir-Barkan Bldg., East Industrial Zone  
Kfar Sava 44102, Israel  
Phone: (972-9) 764.4100  
Fax: (972-9) 7674324  
E-mail: www.bar-tec.com

**SOUTH AFRICA**

**Amphenol South Africa**  
30 Impala Road  
Chislehurst  
Sandton, 2146, South Africa  
Tel: (27-11) 783-9517  
Fax: (27-11) 783-9519  
E-mail: amphenol\_africa@csi.com

**TURKEY**

**Amphenol Turkiye**  
Ayazaga Mah. Meydan Sk. No. 28  
Beybi Giz Plaza, Kat. 26 Maslak  
34396 Istanbul  
Phone: 90 (212) 335 25 01  
Fax: 990 (212) 335 25 00

**Asia / Pacific**

**AUSTRALIA**

**Amphenol Australia LTD**  
2 Fiveways Blvd.  
Melbourne, Victoria 3173  
Australia  
Phone: 613 8796 8888  
Fax: 613 8796 8801  
E-mail: info@amphenol.com.au

**RUSSIA**

**Amphenol Russia Office**  
8-2 Yaroslavskaja Str.  
129164 Moscow, Russia  
Phone: 7495 937 634  
E-mail: russia@amphenol.com

**CHINA**

**Amphenol Aerospace China Office**  
Phone: +607-563-4060  
E-mail: ChinaSales@amphenol-  
aao.com

**INDIA**

**Amphenol Interconnect India Pvt,  
Ltd.**  
105 Bhosari Industrial Area  
Pune, 411 026, India  
Phone: (91-20) 27120 481  
Fax: (91-20) 27120 581  
E-mail: sales@amphenol-in.com

**JAPAN**

**Amphenol Japan Mil/Aero &  
Industrial**  
471-1, Debra, Ritto-city  
Shiga 520-3041, Japan  
Phone: 81-77-553-8501  
Fax: 81-77-551-2200

**KOREA**

**Amphenol Aerospace Korea Office**  
Phone: +607-563-4061  
E-mail: KoreaSales@amphenol-  
aao.com

**SOUTHEAST ASIA**

**Amphenol Aerospace South East  
Asia Office**  
Phone: +607-563-4062  
E-mail:  
SouthEastAsiaSales@amphenol-  
aao.com

**TAIWAN**

**Amphenol Aerospace Taiwan Office**  
Phone: +607-563-4063  
E-mail: TaiwanSales@amphenol-  
aao.com

**Notice:** Specifications are subject to change without notice. Contact your nearest Amphenol Corporation Sales Office for the latest specifications. All statements, information and data given herein are believed to be accurate and reliable but are presented without guarantee, warranty, or responsibility of any kind expressed or implied. Statements or suggestions concerning possible use of our products are made without representation or warranty that any such use is free of patent infringement and are not recommendations to infringe any patent. The user should not assume that all safety measures are indicated or that other measures may not be required. Specifications are typical and may not apply to all connectors.