

# LED Module Specifications

## PRODUCT SPECIFICATION

**Model No.: FYLM-3528UXX-02-16-12V-W**

Applications:
<ul style="list-style-type: none"> <li>■ Channel Letters</li> <li>■ Lighting source for shop windows</li> <li>■ Indoor Decoration Lighting</li> <li>■ Advertising Signs</li> <li>■ Replacement for Neon</li> </ul>



CUSTOMER APPROVED SIGNATURES	APPROVED BY	CHECKED BY	PREPARED BY

**NINGBO FORYARD OPTOELECTRONICS CO.,LTD.**

**Add:** NO.115 Qixin Road Ningbo Zhejiang China

**Zip:** 315042

**Tel:** 0086-574-87933652 87927870 87922206

**Fax:** 0086-574-87927917

**E-mail:** Sales@foryard.com (General)

[Http://www.foryard.com](http://www.foryard.com)

Model No.: FYLM-3528UXX-02-16-12V-W

■ Photo

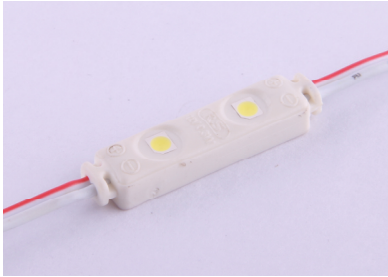

■ Features

1. High luminous efficacy with 3528 SMD LED mounted;
2. High-pressure injection technology
3. Maximum module quantity per string up to 50 pcs
4. Certification: CE, RoHS, UL94 V-0

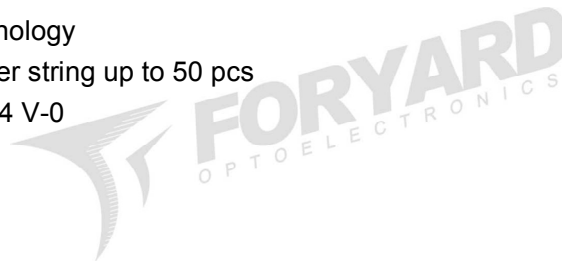

■ Profile Drawings

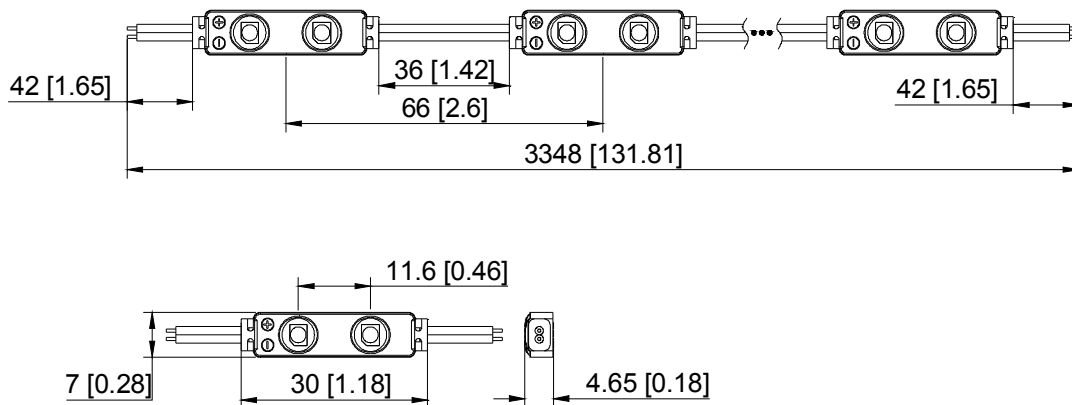

Notes:

1. All dimensions are millimeters.
2. Tolerance is  $\pm 1$ mm unless otherwise specified.
3. Specifications are subject to change without notice.

**Model No.: FYLM-3528UXX-02-16-12V-W**

**Rating Electrical/Optical Characteristics(1 PCS)**

Item	Warm White	White	Cold White	Red	Green	Blue	Yellow
Color Temperature(K) Wavelength(nm)	3000	6000	9000	620~625	525~530	465~470	585~590
Luminous Flux(lm/piece)	16	16	16	6	8	2	5.2
CRI	≥75	≥75	≥75	-	-	-	-
Luminous Efficiency(lm/W)	53	53	53	18.2	27	7	15.8
Working Voltage (V )	DC12						
Beam Angle (°)	115						
Working Current	25	25	25	27	25	25	27
Power(W/piece)	0.3	0.3	0.3	0.33	0.3	0.3	0.33
net weight:(g)	1.5						
LED Quantity(pcs)	1						
Dimension:(mm)	30.0*7.0*4.65						
Life Time(hrs)	13000						
Operation Temperature(°C)	-25~+60						
IP Grade	IP 65						
Approval	CE (NO: E8 06 01 57489 001)						

**Rating Electrical/Optical Characteristics(50 PCS)**

LED Color	Warm White	White	Cold White	Red	Green	Blue	Yellow
Power Dissipation	15W	15W	15W	16.5W	15W	15W	16.5W
Total Length	9.189m±0.1m						
Input Current(mA)	1250	1250	1250	1350	1250	1250	1350
Weight	75g						

**Notes:**

1. Testing environment temperature: 25±2°C
2. The above data are typical values; the actual data of each single product could differ from the typical values. The data subject to change without prior notice.

**Model No.: FYLM-3528UXX-02-16-12V-W**

**Package(5 meters)**

The backsides of all products will stick '3M' branded double-sided sticker with 10mm width.

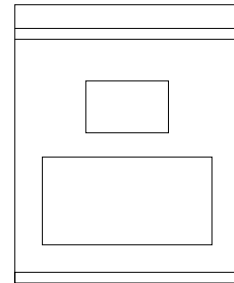
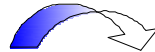
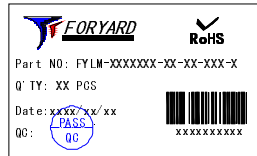

XPCS/Polybag

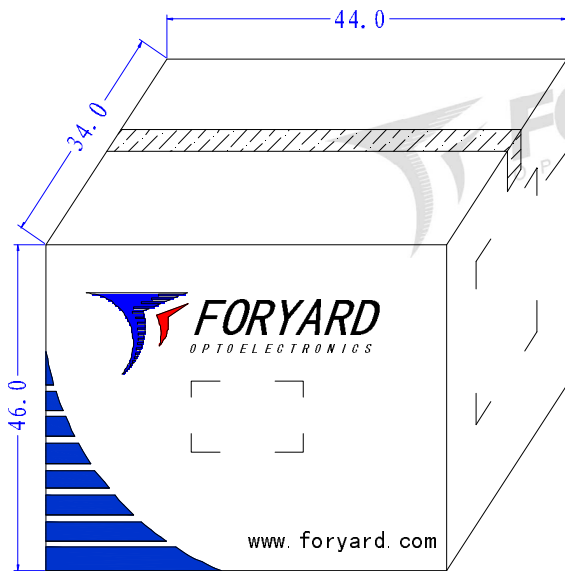

24Boxes/Carton

OUTSIDE LABEL

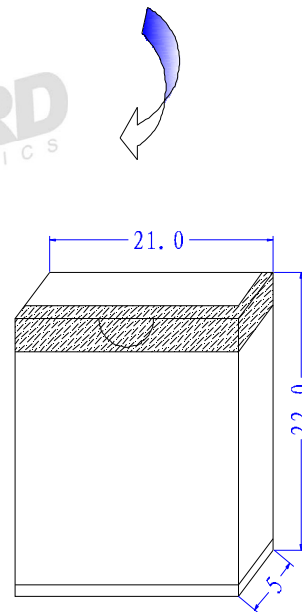
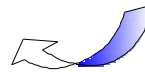

xPolybags/Box



OUTSIDE LABEL

Note: The specifications are subject to change without notice. Please contact us for updated information.