

FEATURES

Low conversion loss: 9 dB
No dc bias and no external matching required
Ideal for upconversion and downconversion
Wideband IF range: DC to 4 GHz
Ultrasmall package: 8-Lead MINI_SO_EP

APPLICATIONS

Very small aperture terminals (VSAT) and mobile satellite communication terminals
Microwave and military radio
Wireless backhaul equipment
Automotive, dedicated short range communications (DSRC) and intelligent vehicle highway systems (IVHS)
Military radar, electronic warfare (EW), and electronic counter measure (ECM) subsystems

GENERAL DESCRIPTION

The HMC220B is an ultraminiature, double-balanced mixer in an 8-lead mini small outline package with exposed pad (MINI_SO_EP). This fundamental, monolithic microwave integrated circuit (MMIC) mixer is constructed of gallium arsenide (GaAs) Schottky diodes and planar transformer baluns on the chip.

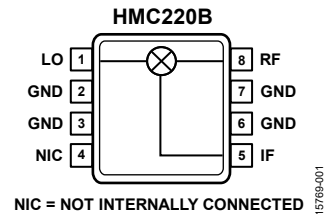
FUNCTIONAL BLOCK DIAGRAM*Figure 1.*

The device can be used as an upconverter, downconverter, biphas demodulator, or phase comparator from 5 GHz to 12 GHz. The HMC220B provides excellent local oscillator (LO) to radio frequency (RF) and LO to intermediate frequency (IF) isolation due to optimized balun structures and operates as low as 7 dBm. The RoHS compliant HMC220B eliminates the need for wire bonding and is compatible with high volume surface-mount manufacturing techniques.

TABLE OF CONTENTS

Features	1	Downconverter Performance	6
Applications.....	1	Upconverter Performance.....	10
Functional Block Diagram	1	Isolation and Return Loss	11
General Description	1	IF Bandwidth	13
Revision History	2	Spurious Performance	15
Specifications.....	3	Theory of Operation	16
Absolute Maximum Ratings.....	4	Applications Information.....	17
Thermal Resistance	4	Evaluation PCB Information	17
ESD Caution.....	4	Typical Applications Circuit	17
Pin Configuration and Function Descriptions.....	5	Outline Dimensions.....	18
Interface Schematics.....	5	Ordering Guide	18
Typical Performance Characteristics	6		

REVISION HISTORY

10/2019—Rev. B to Rev. C

Changes to Table 1.....	3
Change to Table 2 and Table 3	4
Updated Outline Dimensions	18
Changes to Ordering Guide	18

8/2018—Rev. A to Rev. B

Changes to Continuous Power Dissipation, P_{DISS} Parameter and Maximum Junction Temperature Parameter, Table 2 and Table 3	4
---	---

10/2017—Rev. 0 to Rev. A

Changes to LO to RF Parameter, Table 1.....	3
Changes to Figure 35 and Figure 38.....	11
Changes to Ordering Guide	18

7/2017—Revision 0: Initial Version

SPECIFICATIONS

$T_A = 25^\circ\text{C}$, IF = 100 MHz, LO drive level = 10 dBm. All measurements performed as a downconverter with the lower sideband selected, unless otherwise noted.

Table 1.

Parameter	Symbol	Min	Typ	Max	Unit
FREQUENCY RANGE					
Radio Frequency	RF	5		12	GHz
Local Oscillator	LO	5		12	GHz
Intermediate Frequency	IF	DC		4	GHz
LO DRIVE LEVEL					
		7	10		dBm
PERFORMANCE AT LO DRIVE = 10 dBm					
Conversion Loss			9.5	12	dB
Single Sideband (SSB) Noise Figure	NF		9.5		dB
Input Third-Order Intercept	IIP3	12	17		dBm
Input Second-Order Intercept	IIP2		50		dBm
Input 1 dB Compression Point	IP1dB		9.5		dBm
PERFORMANCE AT LO DRIVE = 13 dBm					
Conversion Loss			9	13	dB
SSB Noise Figure	NF		9		dB
Input Third-Order Intercept	IIP3	12	18.5		dBm
Input Second-Order Intercept	IIP2		60		dBm
Input 1 dB Compression Point	IP1dB		11		dBm
ISOLATION					
RF to IF			20		dB
LO to RF		31	40		dB
LO to IF		23	38		dB

ABSOLUTE MAXIMUM RATINGS

Table 2.

Parameter	Rating
RF Input Power	25 dBm
LO Input Power	25 dBm
IF Input Power	25 dBm
IF Source and Sink Current	3 mA
Continuous Power Dissipation, P_{DISS} ($T_A = 85^\circ\text{C}$, Derate 5.5 mW/ $^\circ\text{C}$ Above 85°C)	495 mW
Junction Temperature	175°C
Peak Reflow Temperature (Moisture Sensitivity Level (MSL1)) ¹	260°C
Operating Temperature Range	-40°C to $+85^\circ\text{C}$
Storage Temperature Range	-65°C to $+125^\circ\text{C}$
Electrostatic Discharge (ESD) Sensitivity	
Human Body Model (HBM)	2000 V (Class 2)
Field Induced Charged Device Model (FICDM)	750 V (Class C4)

¹ See the Ordering Guide section.

Stresses at or above those listed under Absolute Maximum Ratings may cause permanent damage to the product. This is a stress rating only; functional operation of the product at these or any other conditions above those indicated in the operational section of this specification is not implied. Operation beyond the maximum operating conditions for extended periods may affect product reliability.

THERMAL RESISTANCE

Thermal performance is directly linked to printed circuit board (PCB) design and operating environment. Careful attention to PCB thermal design is required.

Table 3. Thermal Resistance

Package Type	θ_{JA}	θ_{JC}	Unit
RH-8-1 ¹	104.7	180	$^\circ\text{C}/\text{W}$

¹ Thermal impedance simulated values are based on JEDEC 2S2P test board with 3 mm × 3 mm thermal vias. See JEDEC JESD51-12 for additional information.

ESD CAUTION



ESD (electrostatic discharge) sensitive device. Charged devices and circuit boards can discharge without detection. Although this product features patented or proprietary protection circuitry, damage may occur on devices subjected to high energy ESD. Therefore, proper ESD precautions should be taken to avoid performance degradation or loss of functionality.

PIN CONFIGURATION AND FUNCTION DESCRIPTIONS

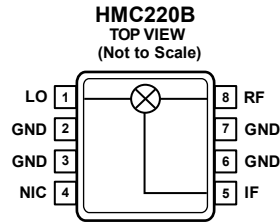

- NOTES**
1. NIC = NOT INTERNALLY CONNECTED. THIS PIN CAN BE LEFT FLOATING OR IT CAN BE SOLDERED DOWN TO RF/DC GND. THE NIC PIN DOES NOT AFFECT THE PERFORMANCE OF THE HMC220B.
 2. EXPOSED PAD. CONNECT THE EXPOSED PAD TO A LOW IMPEDANCE THERMAL AND ELECTRICAL GROUND PLANE.

15769-002

Figure 2. Pin Configuration

Table 4. Pin Function Descriptions

Pin No.	Mnemonic	Description
1	LO	Local Oscillator. This pin is ac-coupled and matched to 50 Ω. See Figure 4 for the LO interface schematic.
2, 3, 6, 7	GND	Ground. Connect the package bottom to RF/dc ground. See Figure 3 for the GND interface schematic.
4	NIC	Not Internally Connected. This pin can be left floating or it can be soldered down to RF/dc GND. The NIC pin does not affect the performance of the HMC220B.
5	IF	Intermediate Frequency. This pin is dc-coupled. For applications not requiring operations to dc, dc block this port externally using a series capacitor whose value is chosen to pass the necessary IF frequency range. For operation to dc, this pin must not source or sink 3 mA of current, or the device is nonfunctioning and possible device failure may result. See Figure 5 for the IF interface schematic.
8	RF EPAD	Radio Frequency. This pin is ac-coupled internally and match to 50 Ω. See Figure 6 for the RF interface schematic. Exposed Pad. Connect the exposed pad to a low impedance thermal and electrical ground plane.

INTERFACE SCHEMATICS



Figure 3. GND Interface Schematic

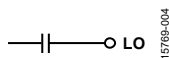

Figure 4. LO Interface Schematic

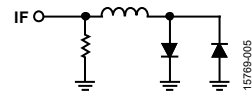

Figure 5. IF Interface Schematic

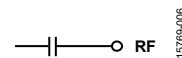

Figure 6. RF Interface Schematic

TYPICAL PERFORMANCE CHARACTERISTICS

DOWNCONVERTER PERFORMANCE

Downconverter Performance at IF = 100 MHz, Lower Sideband

Data taken at LO = 10 dBm, T_A = 25°C, unless otherwise noted.

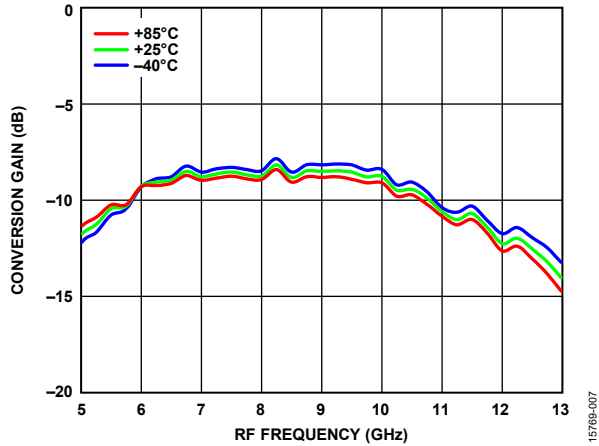

Figure 7. Conversion Gain vs. RF Frequency at Various Temperature

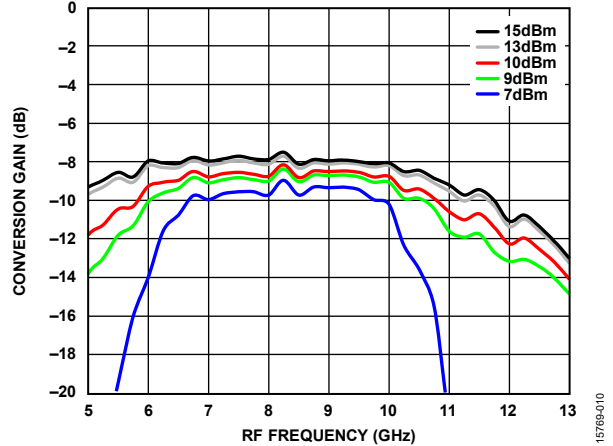

Figure 10. Conversion Gain vs. RF Frequency at Various LO Powers

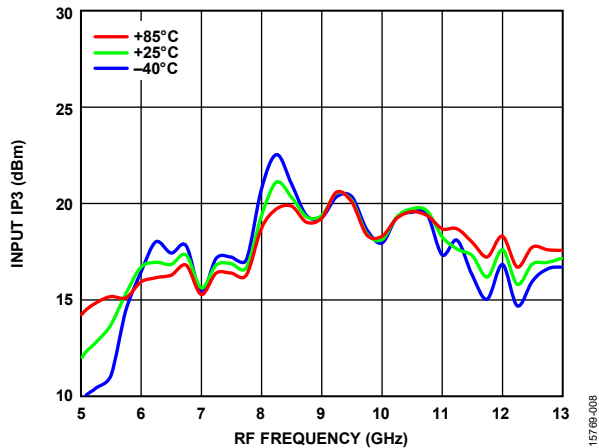

Figure 8. Input IP3 vs. RF Frequency at Various Temperatures

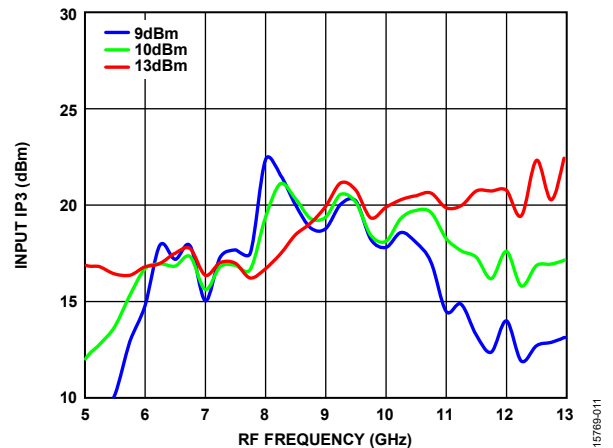

Figure 11. Input IP3 vs. RF Frequency at Various LO Powers

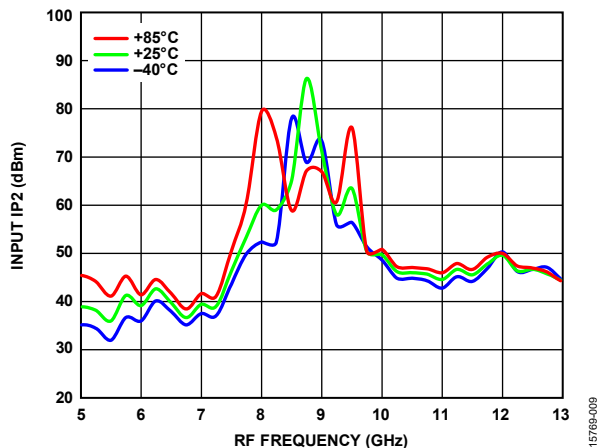

Figure 9. Input IP2 vs. RF Frequency at Various Temperatures

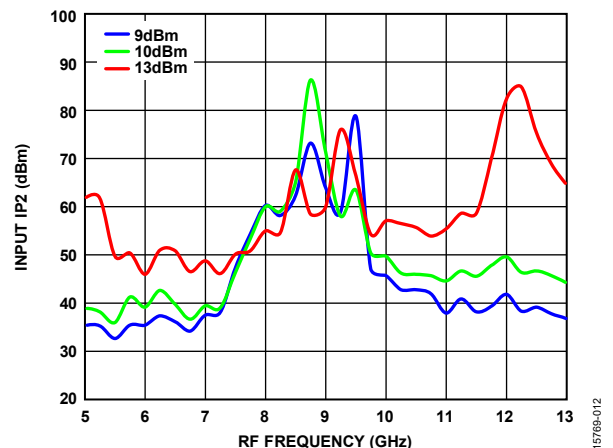

Figure 12. Input IP2 vs. RF Frequency at Various LO Powers

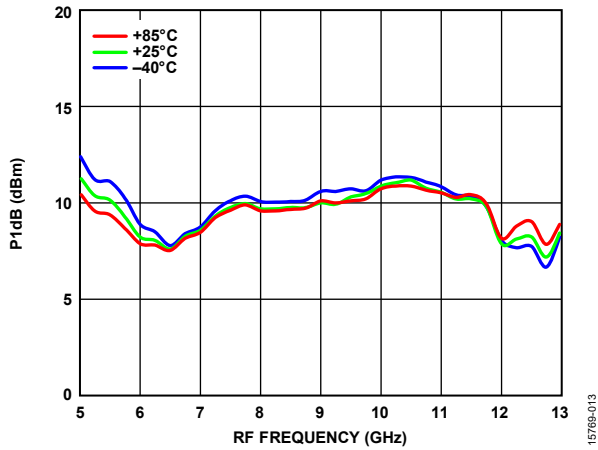

Figure 13. Input P1dB vs. RF Frequency at Various Temperatures

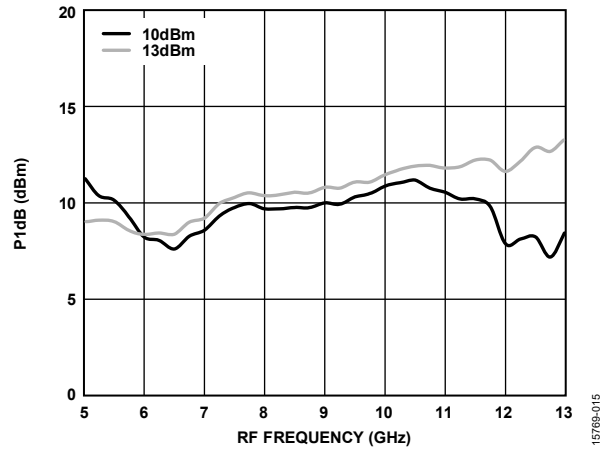

Figure 15. Input P1dB vs. RF Frequency at Various LO Powers

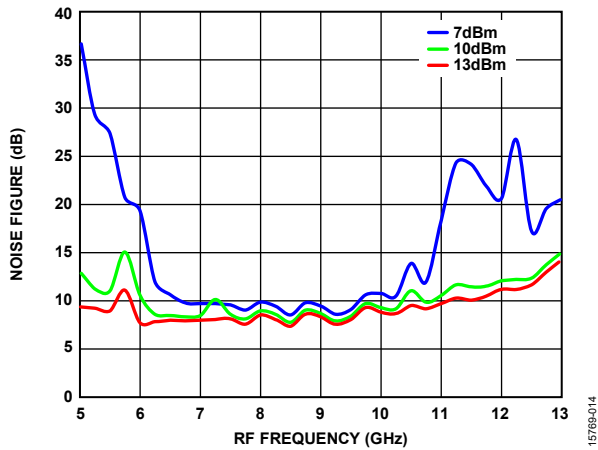

Figure 14. Noise Figure vs. RF Frequency at Various LO Powers

15769-013

15769-015

15769-014

Downconverter Performance at IF = 1000 MHz, Lower Sideband

Data taken at LO = 10 dBm, T_A = 25°C, unless otherwise noted.

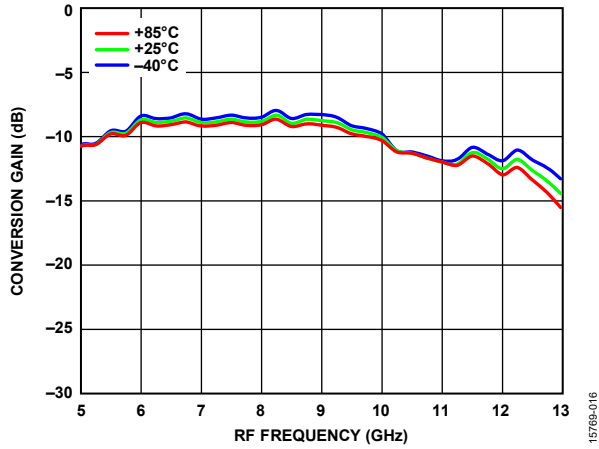

Figure 16. Conversion Gain vs. RF Frequency at Various Temperatures

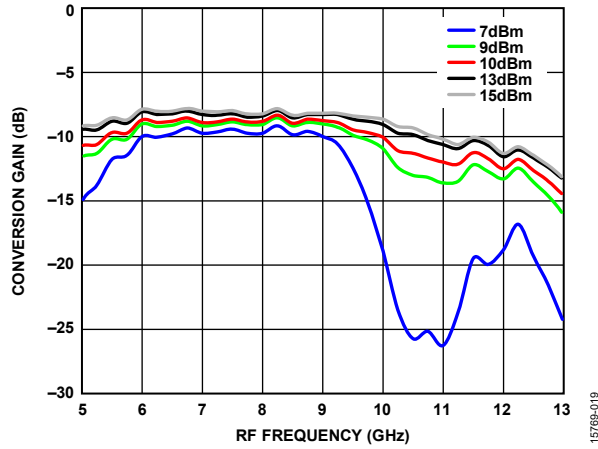

Figure 19. Conversion Gain vs. RF Frequency at Various LO Powers

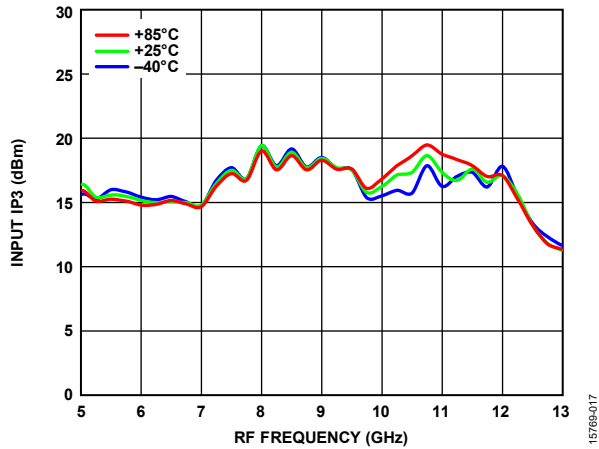

Figure 17. Input IP3 vs. RF Frequency at Various Temperatures

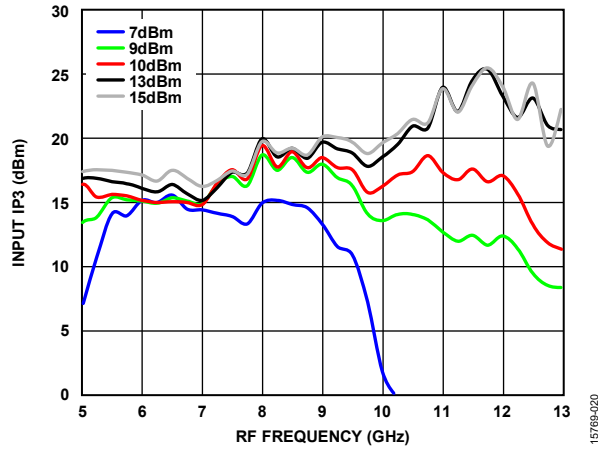

Figure 20. Input IP3 vs. RF Frequency at Various LO Powers

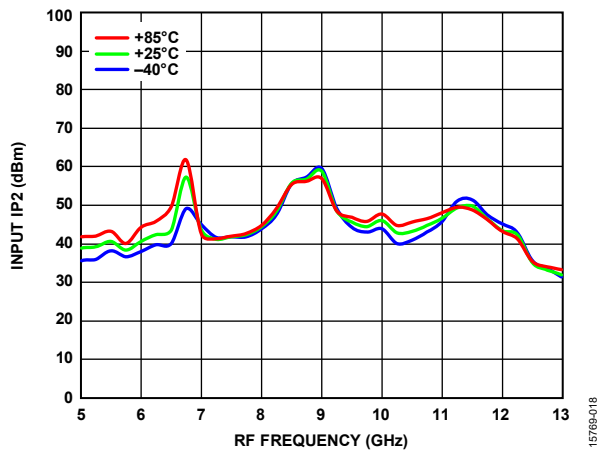

Figure 18. Input IP2 vs. RF Frequency at Various Temperatures

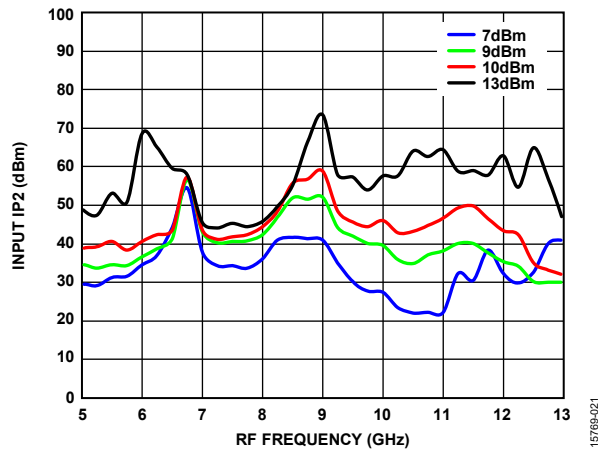

Figure 21. Input IP2 vs. RF Frequency at Various LO Powers

Downconverter Performance at IF = 3000 MHz, Lower Sideband

Data taken at LO = 10 dBm, T_A = 25°C, unless otherwise noted.

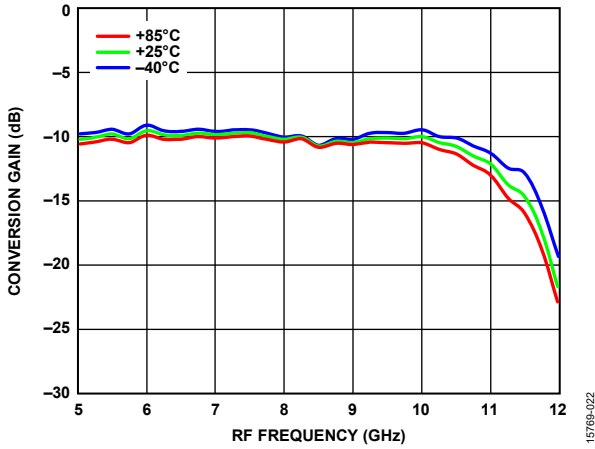

Figure 22. Conversion Gain vs. RF Frequency at Various Temperatures

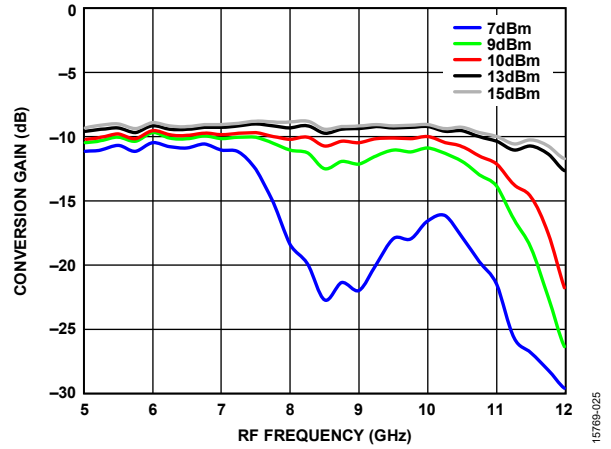

Figure 25. Conversion Gain vs. RF Frequency at Various LO Powers

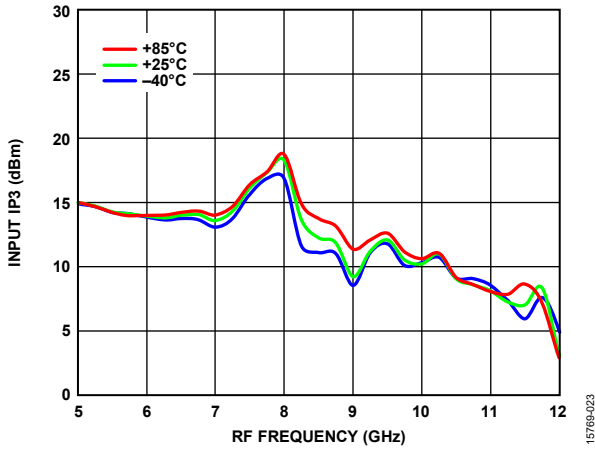

Figure 23. Input IP3 vs. RF Frequency at Various Temperatures

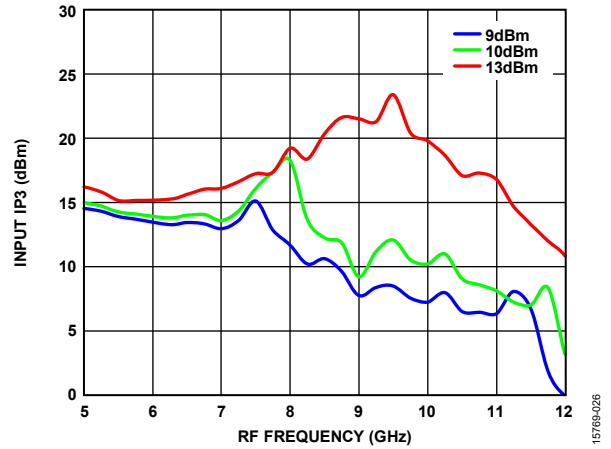

Figure 26. Input IP3 vs. RF Frequency at Various LO Powers

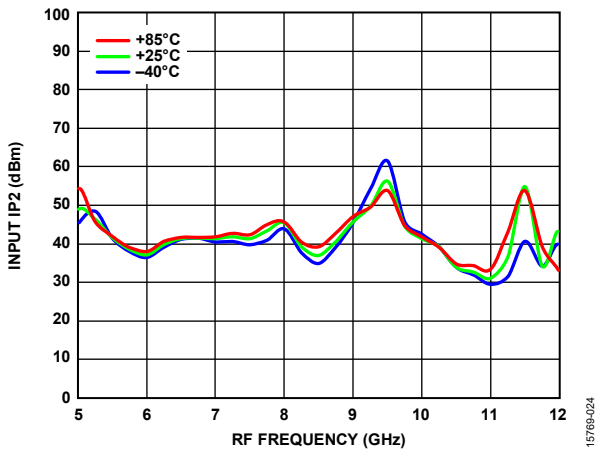

Figure 24. Input IP2 vs. RF Frequency at Various Temperatures

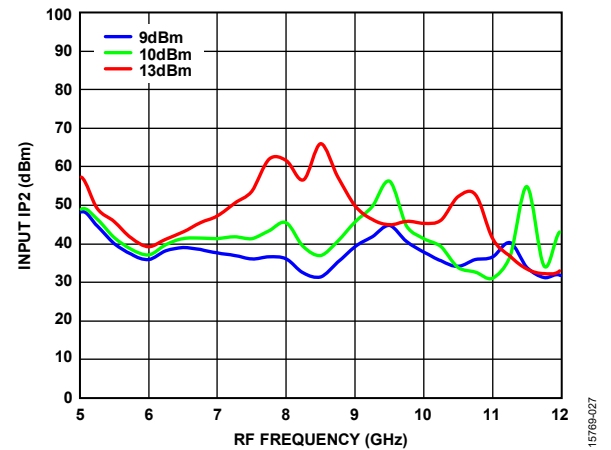

Figure 27. Input IP2 vs. RF Frequency at Various LO Powers

UPCONVERTER PERFORMANCE

Upconverter Performance at IF = 100 MHz, Upper Sideband

Data taken at LO = 10 dBm, T_A = 25°C, unless otherwise noted.

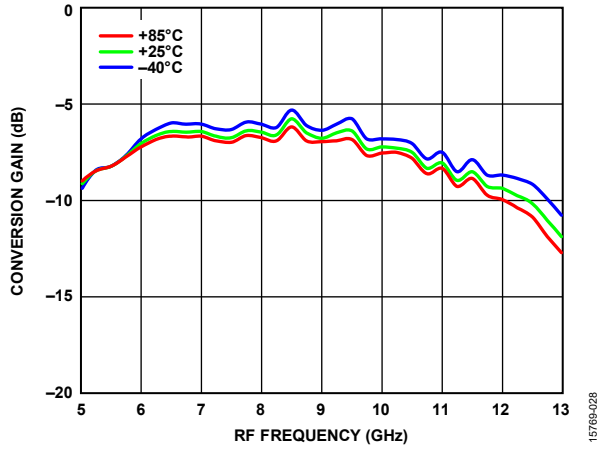

Figure 28. Conversion Gain vs. RF Frequency at Various Temperatures

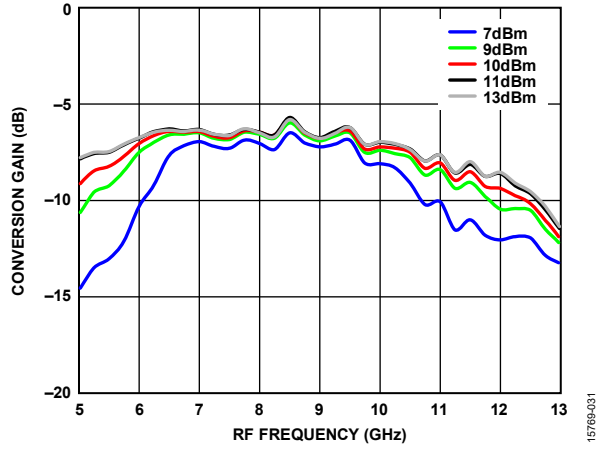

Figure 31. Conversion Gain vs. RF Frequency at Various LO Powers

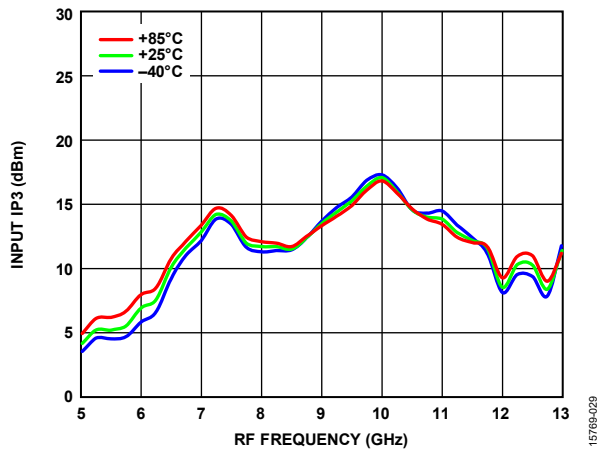

Figure 29. Input IP3 vs. RF Frequency at Various Temperatures

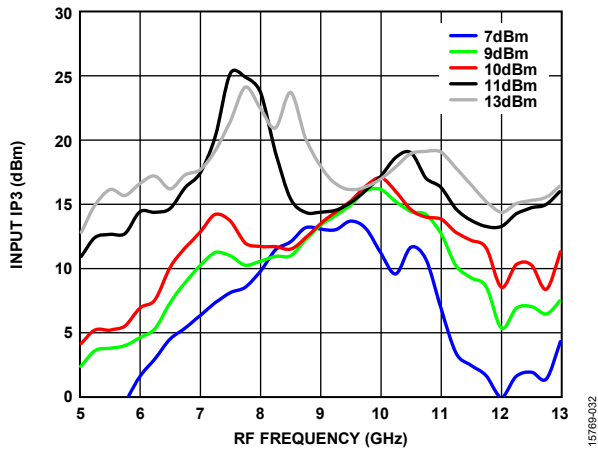

Figure 32. Input IP3 vs. RF Frequency at Various LO Powers

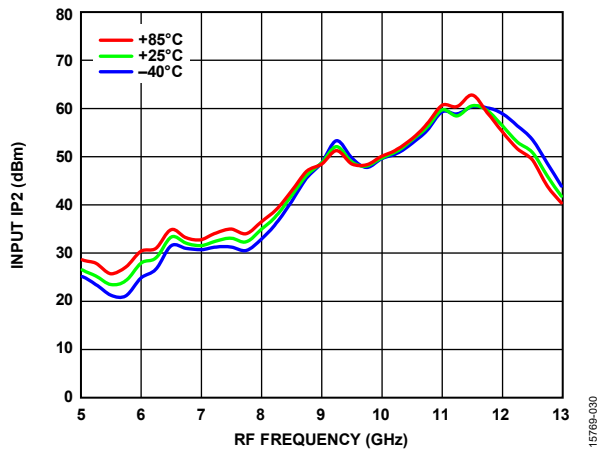

Figure 30. Input IP2 vs. RF Frequency at Various Temperatures

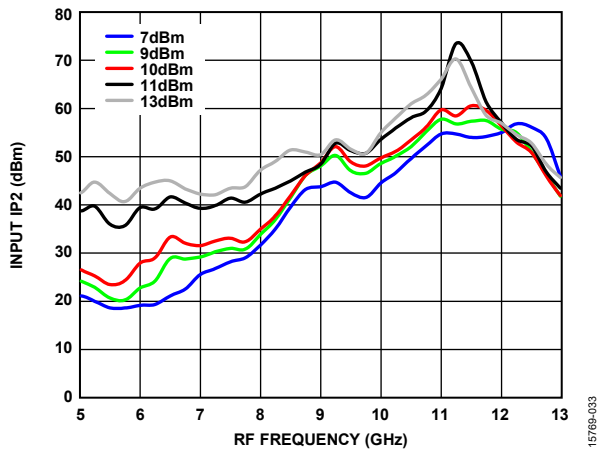

Figure 33. Input IP2 vs. RF Frequency at Various LO Powers

ISOLATION AND RETURN LOSS

Data taken at IF = 100 MHz, LO = 10 dBm, $T_A = 25^\circ\text{C}$, unless otherwise noted.

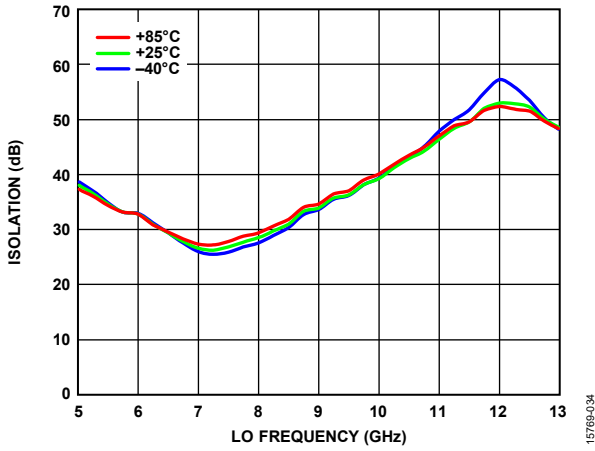

Figure 34. LO to IF Isolation vs. LO Frequency at Various Temperatures

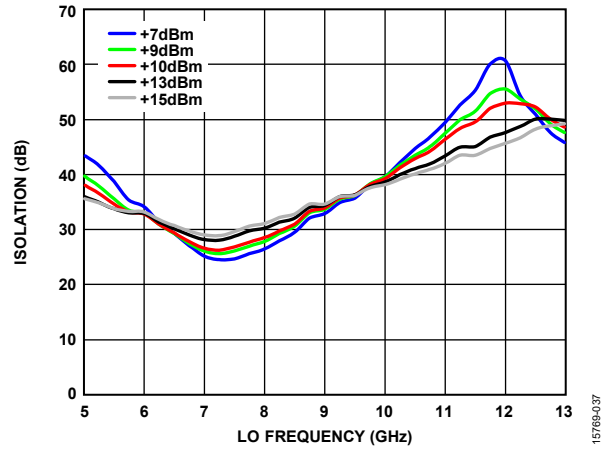

Figure 37. LO to IF Isolation vs. LO Frequency at Various LO Powers

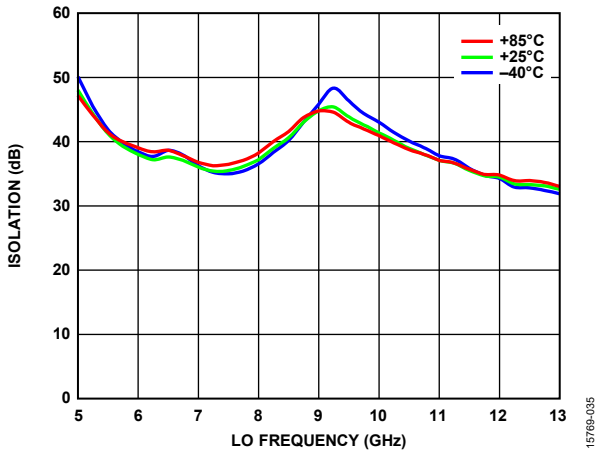

Figure 35. LO to RF Isolation vs. LO Frequency at Various Temperatures

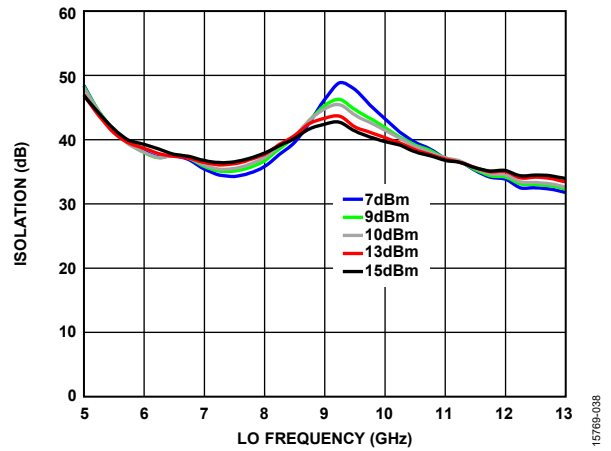

Figure 38. LO to RF Isolation vs. LO Frequency at Various LO Powers

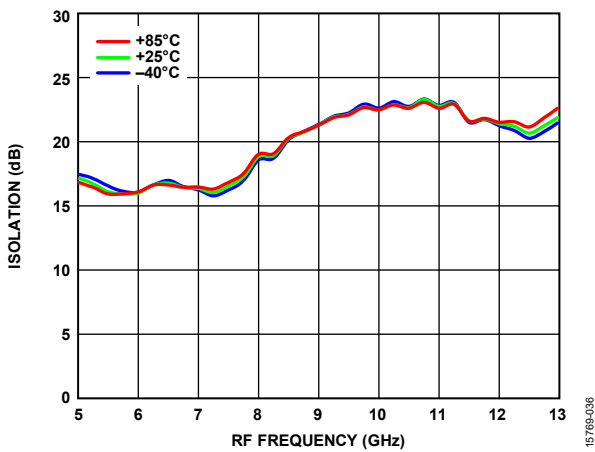

Figure 36. RF to IF Isolation vs. RF Frequency at Various Temperatures

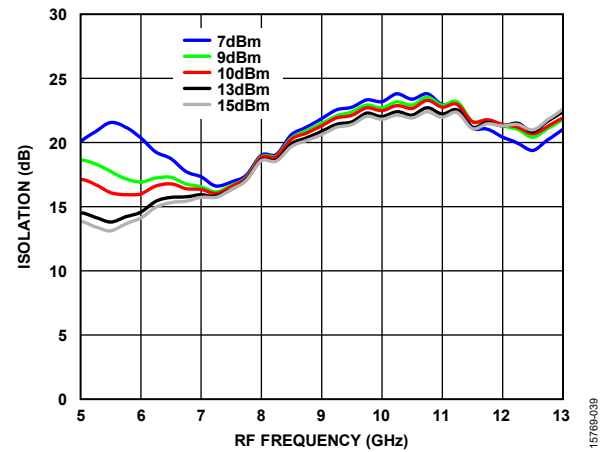

Figure 39. RF to IF Isolation vs. RF Frequency at Various LO Powers

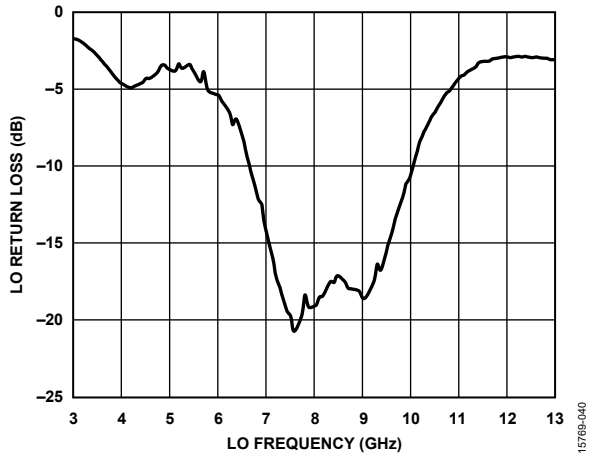

Figure 40. LO Return Loss vs. LO Frequency

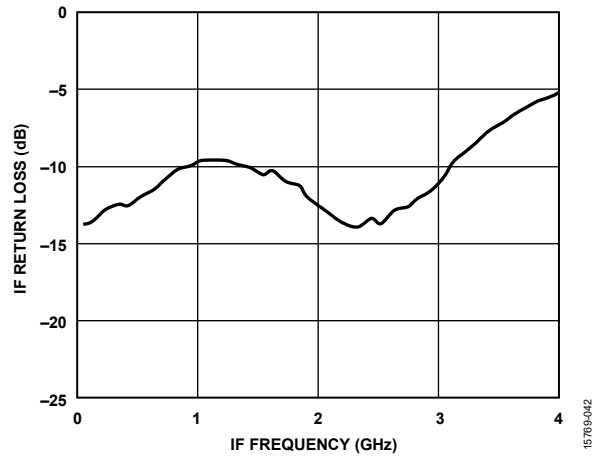

Figure 42. IF Return Loss vs. IF Frequency

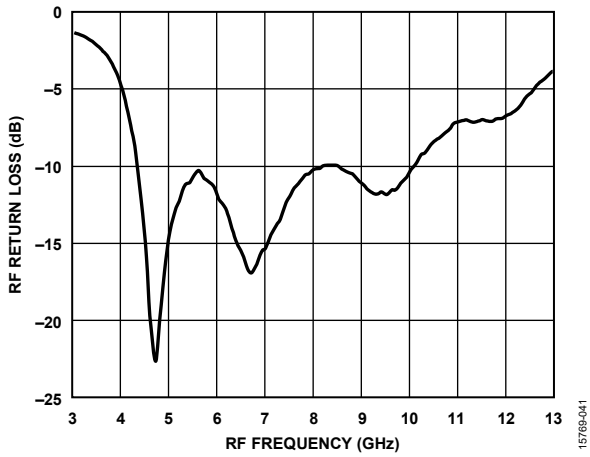

Figure 41. RF Return Loss vs. RF Frequency

15769-040

15769-042

15769-041

IF BANDWIDTH

Downconverter Performance, Lower Sideband

Data taken at LO = 10 dBm, T_A = 25°C, unless otherwise noted.

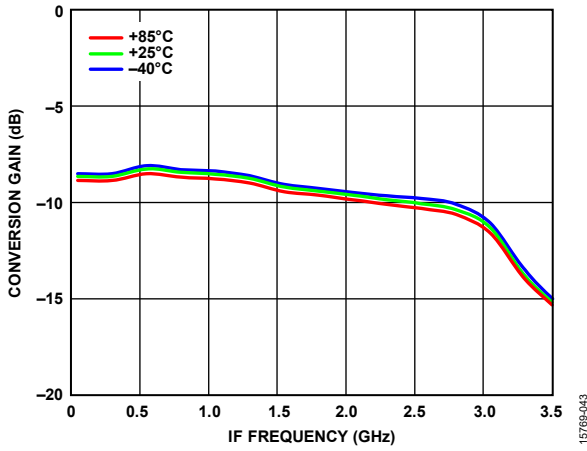

Figure 43. Conversion Gain vs. IF Frequency at Various Temperatures

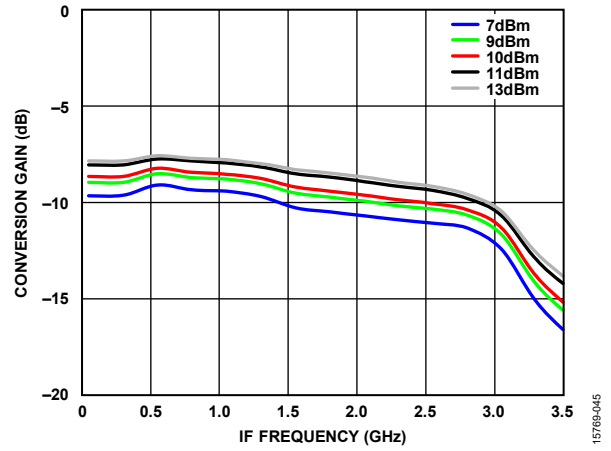

Figure 45. Conversion Gain vs. IF Frequency at Various LO Drives

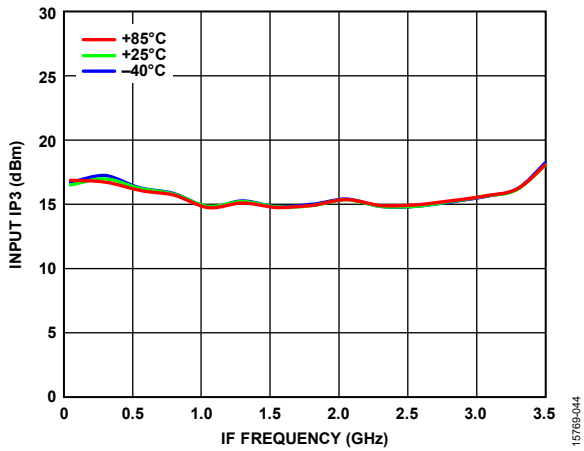

Figure 44. Input IP3 vs. IF Frequency at Various Temperatures

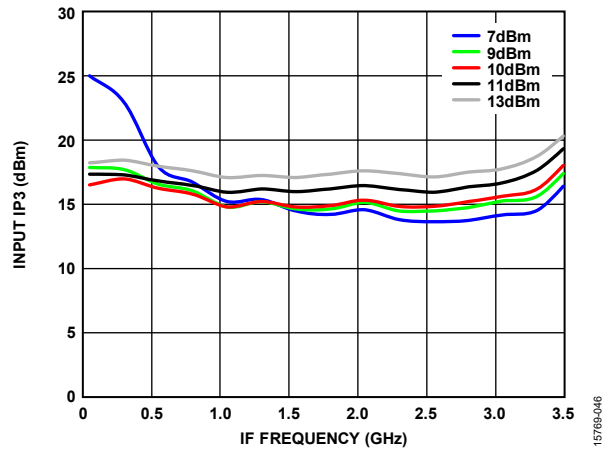

Figure 46. Input IP3 vs. IF Frequency at Various LO Drives

Downconverter Performance, Upper Sideband

Data taken at LO = 10 dBm, T_A = 25°C, unless otherwise noted.

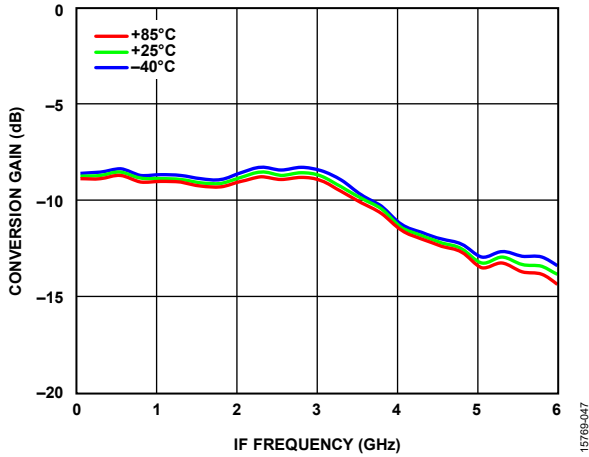

Figure 47. Conversion Gain vs. IF Frequency at Various Temperatures

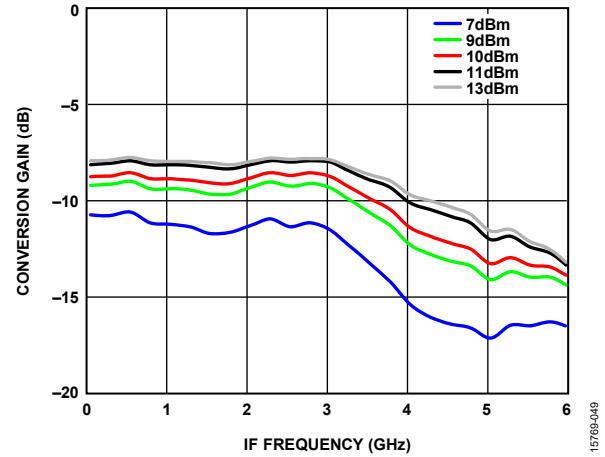

Figure 49. Conversion Gain vs. IF Frequency at Various LO Drives

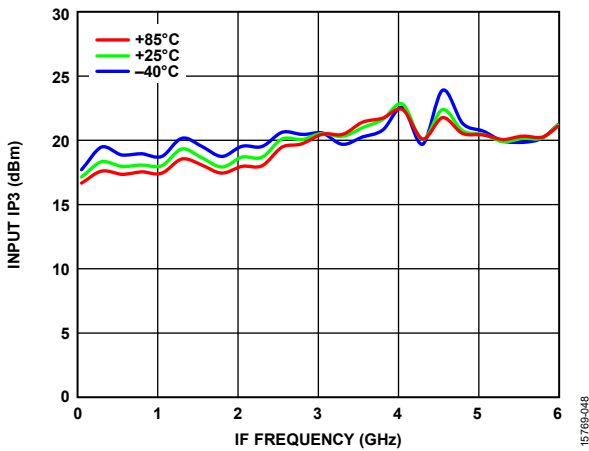

Figure 48. Input IP3 vs. IF Frequency at Various Temperatures

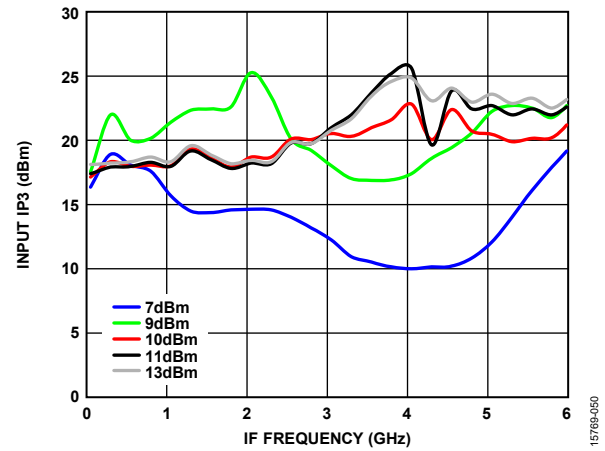

Figure 50. Input IP3 vs. IF Frequency at Various LO Drives

SPURIOUS PERFORMANCE

Mixer spurious products are measured in decibels relative to carrier from the IF output power level, unless otherwise noted.

Spur values are $(M \times RF) - (N \times LO)$.

Harmonics of LO

LO Power = 10 dBm. Values are in decibels relative to carrier (dBc) below the input LO level measured at the RF port.

LO Frequency (GHz)	N _{LO} Spur at RF Port(dBc)			
	1	2	3	4
6	42	42	57	91
7	36	47	52	51
9	39	44	72	71
10	43	55	52	76
12	36	65	72	84
13	33	57	60	N/A ¹

¹ N/A means not applicable.

M × N Spurious Outputs, IF = 100 MHz

RF = 5000 MHz, LO = 5100 MHz, LO power = +10 dBm, RF power = -10 dBm.

M × RF	0	N × LO				
		1	2	3	4	5
	N/A ¹	7	25	31	52	56
1	5	0	12	29	40	43
2	57	63	60	62	64	71
3	77	60	49	50	52	65
4	83	85	88	89	88	84
5	82	84	85	87	79	78

¹ N/A means not applicable.

RF = 8500 MHz, LO = 8600 MHz, LO power = +10 dBm, RF power = -10 dBm.

M × RF	0	N × LO				
		1	2	3	4	5
	N/A ¹	2	28	29	54	46
1	12	0	23	46	68	50
2	80	49	57	46	83	82
3	88	82	75	69	68	85
4	82	87	88	89	96	86
5	80	85	86	88	95	95

¹ N/A means not applicable.

RF = 12000 MHz, LO = 12100 MHz, LO power = +10 dBm, RF power = -10 dBm.

M × RF	0	N × LO				
		1	2	3	4	5
	N/A ¹	20	35	39	56	0
1	9	0	26	59	62	61
2	85	63	69	80	86	75
3	75	84	77	61	77	86
4	62	76	87	89	94	89
5	0	63	75	85	87	95

¹ N/A means not applicable.

M × N Spurious Outputs, IF = 1000 MHz

RF = 5000 MHz, LO = 6000 MHz, LO power = +10 dBm, RF power = -10 dBm.

M × RF	0	N × LO				
		1	2	3	4	5
	N/A ¹	-3	+18	+31	+53	+46
1	-6	0	+6	+5	+27	+40
2	+41	+35	+31	+31	+35	+41
3	+40	+27	+5	+6	0	-6
4	+46	+53	+31	+18	-3	0
5	+67	+63	+39	+18	-3	-6

¹ N/A means not applicable.

RF = 8500 MHz, LO = 9500 MHz, LO power = +10 dBm, RF power = -10 dBm.

M × RF	0	N × LO				
		1	2	3	4	5
	N/A ¹	-3	+24	+28	+48	+49
1	+11	0	+21	+40	+62	+52
2	+88	+58	+60	+47	+64	+77
3	+87	+82	+84	+71	+72	+80
4	+84	+84	+90	+94	+95	+95
5	+81	+87	+87	+89	+87	+95

¹ N/A means not applicable.

RF = 12000 MHz, LO = 13000 MHz, LO power = +10 dBm, RF power = -10 dBm.

M × RF	0	N × LO				
		1	2	3	4	5
	N/A ¹	14	42	29	55	0
1	10	0	28	63	55	60
2	84	64	83	61	81	77
3	75	84	84	75	73	80
4	64	71	82	85	93	87
5	0	67	73	85	87	88

¹ N/A means not applicable.

THEORY OF OPERATION

The HMC220B is a general-purpose, double balanced mixer in an 8-lead MINI_SO_EP, RoHS compliant package that can be used as an upconverter or a downconverter from 5 GHz to 12 GHz.

When used as a downconverter, the HMC220B downconverts RF between 5 GHz to 12 GHz to IF between dc and 4 GHz.

When used as an upconverter, the mixer upconverts IF between dc and 4 GHz to RF between 5 GHz and 12 GHz.

The mixer provides excellent LO to RF and LO to IF isolation due to optimized balun structures. The HMC220B requires no external components or matching circuitry. The RoHS compliant HMC220B eliminates the need for wire bonding and is compatible with high volume, surface-mount manufacturing techniques.

APPLICATIONS INFORMATION

EVALUATION PCB INFORMATION

The PCB used in this application must use RF circuit design techniques. Signal lines must have 50 Ω impedance, and the package ground lead and exposed pad must be connected directly to the ground planes. The evaluation PCB shown in Figure 52 is available from Analog Devices, Inc., upon request.

TYPICAL APPLICATIONS CIRCUIT

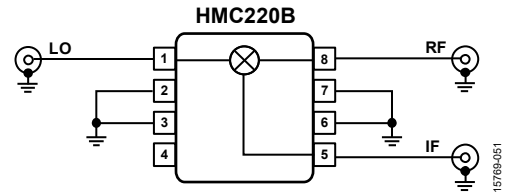

Figure 51. Typical Applications Circuit

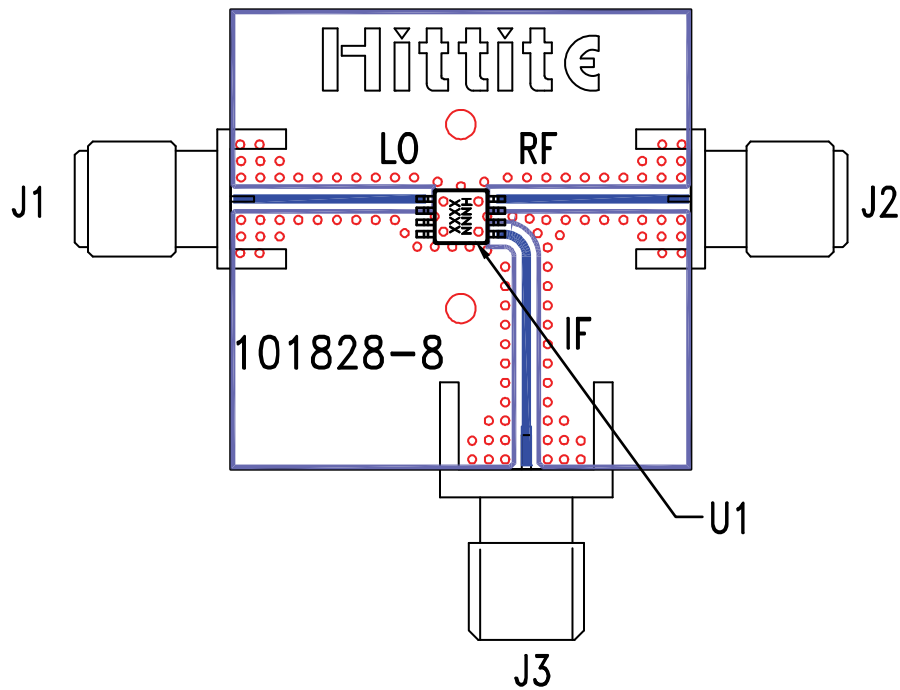
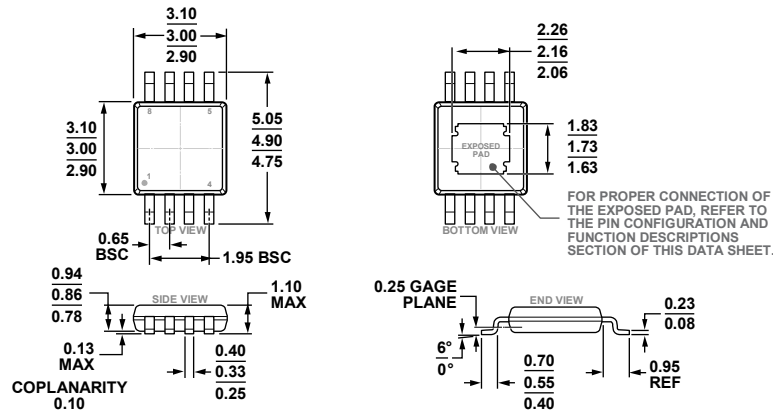

Figure 52. EV1HMC220BMS8G Evaluation PCB

Table 5. EV1HMC220BMS8G PCB Components

Item	Description	Reference Designator	Quantity	Manufacturer	Part Number
1	PCB, EV1HMC220BMS8G		1	Analog Devices	101828-8
2	2.92 mm Subminiature Version A (SMA) connector	J1, J2	2	SRI Connector Gage	21-146-1000-01
3	SMA connector, end launch	J3	1	Cinch Connectivity Solutions Johnson	142-0701-851
4	Device under test (DUT)	U1	1	Analog Devices	HMC220BMS8GE

OUTLINE DIMENSIONS



COMPLIANT TO JEDEC STANDARDS MO-187-AA-T

Figure 53. 8-Lead Mini Small Outline Package with Exposed Pad [MINI_SO_EP] (RH-8-1)

Dimensions shown in millimeters

ORDERING GUIDE

Model ¹	Temperature Range	MSL Rating ²	Package Description	Package Option
HMC220BMS8GE	-40°C to +85°C	MSL1	8-Lead Mini Small Outline Package with Exposed Pad [MINI_SO_EP]	RH-8-1
HMC220BMS8GETR	-40°C to +85°C	MSL1	8-Lead Mini Small Outline Package with Exposed Pad [MINI_SO_EP]	RH-8-1
EV1HMC220BMS8G			Evaluation PCB Assembly	

¹ The HMC220BMS8GE and HMC220BMS8GETR are RoHS Compliant Parts.

² See the Absolute Maximum Ratings section.