

Euro Terminal Ultra-Slim Signal Conditioners M6D Series

DC ALARM

(PC programmable)

Functions & Features

- 5.9-mm wide ultra-slim design
- Low profile allows the M6D module mounted in a 120-mm deep panel
- PC programmable
- High-density mounting
- Power and status indicator LEDs

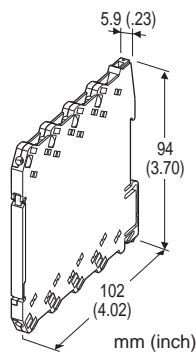

MODEL: M6DXAS-[1]-R[2]

ORDERING INFORMATION

- Code number: M6DXAS-[1]-R[2]
Specify a code from below for each [1] and [2].
(e.g. M6DXAS-Z1-R/Q)
- Input range (e.g. 4 - 20 mA DC)
- Specify the specification for option code /Q
(e.g. /C01/SET)

[1] INPUT

Current

Z1: Range 0 - 50 mA DC (Input resistance 24.9 Ω)

Voltage

S1: Range -1000 - +1000 mV DC (Input resistance 1 MΩ min.)

S2: Range -10 - +10 V DC (Input resistance 1 MΩ min.)

(Configurator software is used to change input over the described range of the selected suffix code.

For changing between suffix codes, set the Input Range Selector on the side of unit before software adjustment.)

OUTPUT

Relay; SPDT or transfer contact

POWER INPUT

DC Power

R: 24 V DC

(Operational voltage range 24 V ±10 %, ripple 10 %p-p max.)

[2] OPTIONS

blank: none

/Q: With options (specify the specification)

SPECIFICATIONS OF OPTION: Q (multiple selections)

COATING (For the detail, refer to M-System's web site.)

/C01: Silicone coating

/C02: Polyurethane coating

EX-FACTORY SETTING

/SET: Preset according to the Ordering Information Sheet

(No. ESU-7828)

RELATED PRODUCTS

- PC configurator software (model: M6CFG)

Downloadable at M-System's web site.

A dedicated cable is required to connect the module to the PC. Please refer to the internet software download site or the users manual for the PC configurator for applicable cable types.

GENERAL SPECIFICATIONS

Connection

Input and output: Euro terminal (torque 0.3 N·m)

Power input: Via the Installation Base (model: M6DBS)

or Euro terminal (torque 0.3 N·m)

Applicable wire size: 0.2 to 2.5 mm², stripped length 8 mm

Housing material: Flame-resistant resin (black)

Isolation: Input to output to power

Power LED: Green light turns on when the power is supplied.

Status indicator LED: Orange LED; Blinking patterns indicate different operating status of the transmitter.

Alarm monitor LED: Red LED turns on when the alarm is tripped.

Programming: Downloaded from PC

Input type and range

Input fine adjustments

Alarm setpoint (input %)

Trip action (High or Low)

Relay coil (energized or de-energized)

Power ON delay time (0 to 999 sec.)

Alarm ON delay time (0 to 999 sec.)

Hysteresis (deadband) (input %)

Alarm test, and others

For detailed information, refer to the users manual for the PC configurator.

Configurator connection: 2.5 dia. miniature jack;

RS-232-C level

Factory default setting

Alarm setpoint: 80 %

Trip action: High

Relay coil at alarm: Energized

Power ON delay time: 5 sec.

Alarm ON delay time: 0 sec.

Hysteresis (deadband) : 1.0 %

INPUT SPECIFICATIONS

■ **DC Current:** Input resistor incorporated

(If not specified, the input range is 4 - 20 mA DC.)

Input range: 0 - 50 mA DC

Minimum span: 2 mA

Offset: Lower range can be any specific value within the input range provided that the minimum span is maintained.

■ **DC Voltage**

• **Code S1 (narrow spans)**

Input range: -1000 - +1000 mV DC

Minimum span: 100 mV

• **Code S2 (wide spans)**

Input range: -10 - +10 V DC

Minimum span: 1 V

Offset: Lower range can be any specific value within the input range provided that the minimum span is maintained.

If not specified, the input range is shown below.

S1: 0 - 100 mV DC

S2: 1 - 5 V DC

OUTPUT SPECIFICATIONS

■ **Relay Output**

Relay rating:

250 V AC @2 A (cos ϕ = 1)

30 V DC @2 A (resistive load)

Maximum switching voltage: 250 V AC or 125 V DC

Maximum switching power: 500 VA or 60 W

Minimum load: 5 V DC @100 mA

Mechanical life: 5×10^6 cycles (rate 180/min.)

Alarm Trip Operation Terminal No. in parentheses

• **Setting Example**

Hi alarm (coil energized at alarm) or

Lo alarm (coil de-energized at alarm)

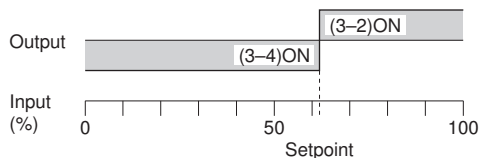

Trip operation in power failure: Terminals 3 - 4 turn ON.

INSTALLATION

Power consumption: Approx. 0.5 W

Operating temperature: -20 to +55°C (-4 to +131°F)

Operating humidity: 30 to 90 %RH (non-condensing)

Mounting: Installation Base (model: M6DBS) or DIN rail

Weight: 65 g (2.3 oz)

PERFORMANCE in percentage of span

Setpoint accuracy (trip point accuracy) : ± 0.05 %

Setpoint accuracy is inversely proportional to the input span.

[Example] Input type 0 - 50 mA, Input range 4 - 20 mA

Max. Input Range (50 mA) \div Span (16 mA) \times 0.05 %

= ± 0.16 %

Temp. coefficient: ± 0.01 %/°C (± 0.006 %/°F) of max. span

Response time: ≤ 0.2 sec. (0 - 100 % at 90 % setpoint)

Line voltage effect: ± 0.1 % over voltage range

Insulation resistance: ≥ 100 M Ω with 500 V DC

Dielectric strength: 2000 V AC @1 minute (input to output to power to ground)

STANDARDS & APPROVALS

EU conformity:

EMC Directive

EMI EN 61000-6-4

EMS EN 61000-6-2

Low Voltage Directive

EN 61010-1

Measurement Category II (output)

Pollution Degree 2

Input or power to output: Reinforced insulation (300 V)

Input to power: Basic insulation (300 V)

RoHS Directive

EN 50581

EXTERNAL VIEW

FRONT VIEW (with the cover open)

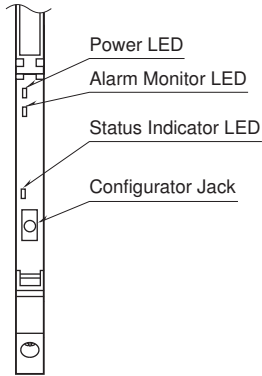

SIDE VIEW

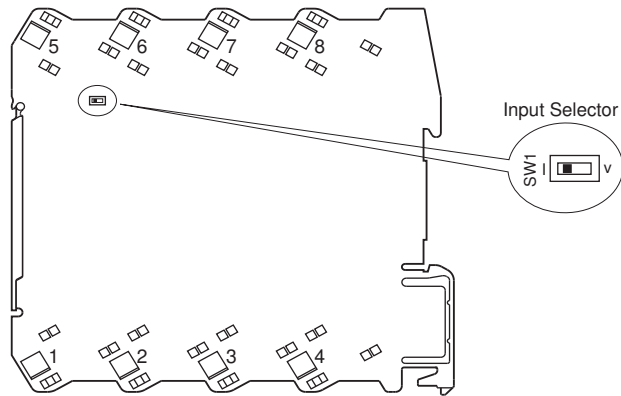

The DIP switch setting is required to select input types before setting a precise input range using PC Configurator Software (model: M6CFG). Refer to the instruction manual for detailed procedures.

EXTERNAL DIMENSIONS & TERMINAL ASSIGNMENTS unit: mm (inch)

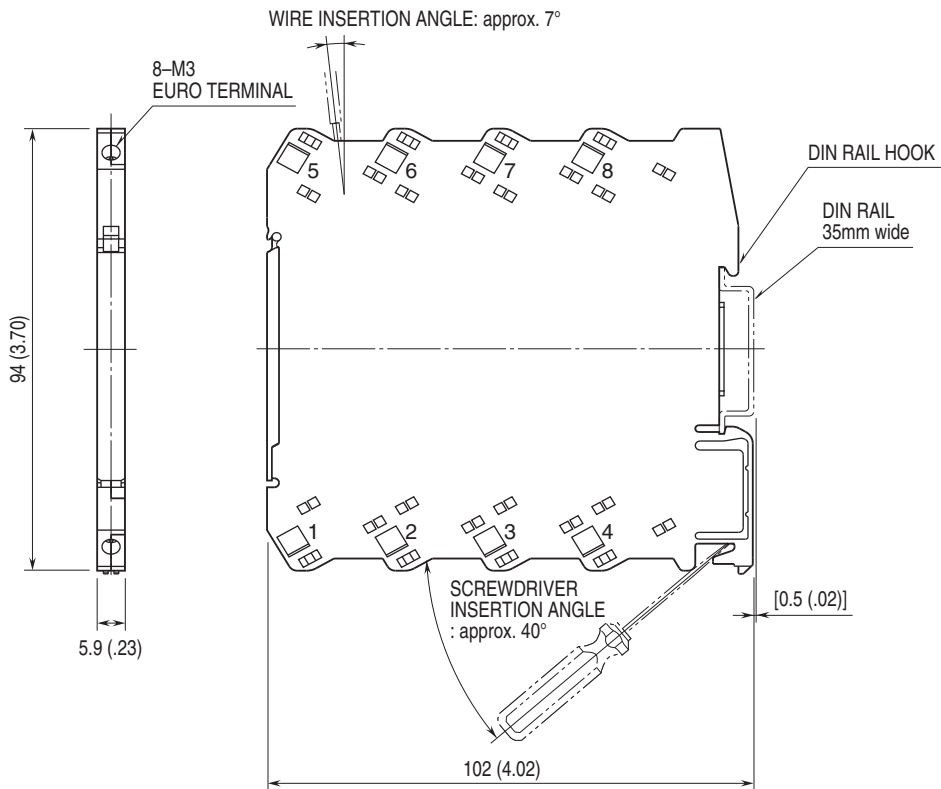

• When mounting, no extra space is needed between units.

SCHEMATIC CIRCUITRY & CONNECTION DIAGRAM

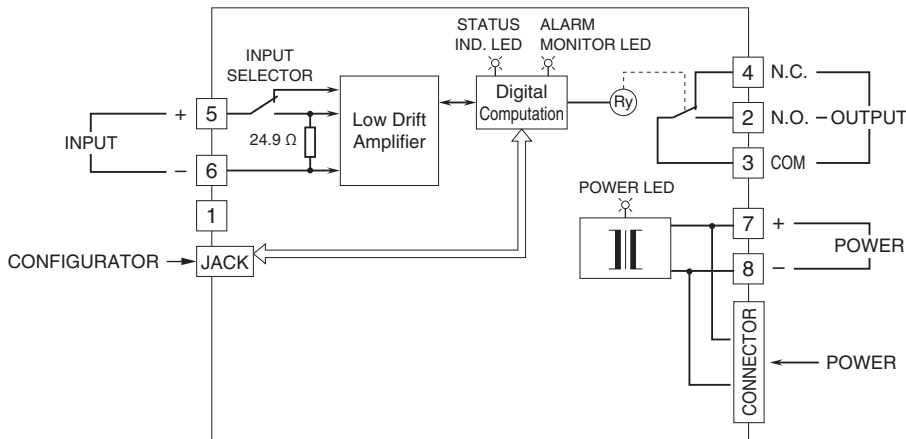

■ Relay Protection
• AC Powered

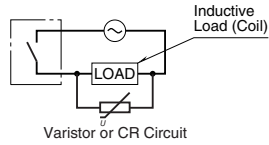

• DC Powered

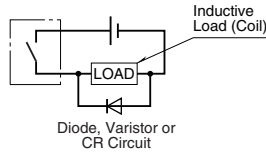

Specifications are subject to change without notice.