

FEATURES

- PNP epitaxial silicon, planar design.
- Collector-emitter voltage $V_{CE} = -40V$.
- Collector current $I_C = 0.2A$.
- In compliance with ER RoHS 2002/95/EC directives.



MECHANICAL DATA

Case: SOT-23, Plastic
 Terminals: Solderable per MIL-STD-750, method 2026
 Approx. Weight: 0.008gram
 Marking: 2A

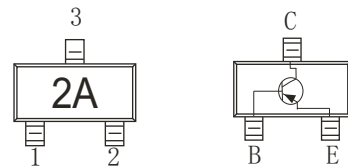

MAXIMUM RATINGS ($T_a = 25^\circ C$ unless otherwise noted)

Symbol	Parameter	Value	Unit
V_{CBO}	Collector-Base Voltage	-40	V
V_{CEO}	Collector-Emitter Voltage	-40	V
V_{EBO}	Emitter-Base Voltage	-5	V
I_C	Collector Current	-0.2	A
P_D	Total Device Dissipation(FR-5 BOARD)	0.225	W
P_D	Total Device Dissipation(Alumina Substrate)	0.3	W
$R_{\theta JA}$	Thermal Resistance Form Junction to Ambient	625	$^\circ C/W$
$R_{\theta JA}$	Thermal Resistance, Junction to Ambient	400	$^\circ C/W$
T_J	Junction Temperature	150	$^\circ C$
T_{STG}	Storage Temperature	-55~+150	$^\circ C$
T	Peak Temperature Soldering	260	$^\circ C$

MMBT3906

ELECTRICAL CHARACTERISTICS (Ta=25°C unless otherwise specified)

Parameter	Symbol	Test Condition	Min.	Typ.	Max.	Units
Collector-Base breakdown voltage	$V_{(BR)CBO}$	$I_C=-10\mu A, I_E=0$	-40			V
Collector-Emitter breakdown voltage	$V_{(BR)CEO}$	$I_C=-1mA, I_B=0$	-40			V
Emitter-Base breakdown voltage	$V_{(BR)EBO}$	$I_E=-10\mu A, I_C=0$	-5			V
Collector cut-off current	I_{CBO}	$V_{CB}=-40V, I_C=0$			-0.1	μA
Collector cut-off current	I_{CEX}	$V_{CE}=-30V, V_{BE(OFF)}=-3V$			-50	nA
Base cut-off current	I_{BEX}				-50	nA
Emitter cut-off current	I_{EBO}	$V_{EB}=-5V, I_C=0$			0.1	μA
DC current gain*	H_{FE}	$I_C=-0.1mA, V_{CE}=-1V$	60			
	H_{FE}	$I_C=-1mA, V_{CE}=-1V$	80			
	H_{FE}	$I_C=-10mA, V_{CE}=-1V$	100		300	
	H_{FE}	$I_C=-50mA, V_{CE}=-1V$	60			
	H_{FE}	$I_C=-100mA, V_{CE}=-1V$	30			
Collector-Emitter saturation voltage	$V_{CE(SAT)}$	$I_C=-10mA, I_B=-1mA$			-0.2	V
		$I_C=-50mA, I_B=-5mA$			-0.3	V
Base-Emitter Saturation voltage*	$V_{BE(SAT)}$	$I_C=-10mA, I_B=-1mA$			-0.9	V
		$I_C=-50mA, I_B=-5mA$			-1	V
Input capacitance	C_{IB}	$V_{CB}=-5V, I_E=0, f=1MHz$			4.0	pF
Output capacitance	C_{OB}	$V_{EB}=-0.5V, I_C=0, f=1MHz$			8.0	pF
Transition frequency	f_T	$I_C=-10mA, V_{CE}=-20V, f=100MHz$	300			MHz
Delay time	t_d	$V_{CC}=-3V, V_{BE}=0.5V, I_C=10mA, I_B=-1mA$			35	nS
Rise time	t_r				35	nS
Storage time	t_s	$V_{CC}=-3V, V_{BE}=0.5V, I_{B1}=I_{B2}=-1mA$			200	nS
Fall time	t_f				50	nS
Noise figure	NF	$V_{CE}=-5V, I_C=-100\mu A, R_s=1K\Omega, f=1KHz$			4	Db
Input Impedance	h_{ie}		2		12	pF
Voltage feedback ratio	h_{re}		0.1		10	$\times 10^4$
Small-signal current gain	h_{fe}		100		400	
Output admittance	h_{oe}		3		60	$\theta mhos$

*Pulse Test: Pulse Width<300 μ S, Duty Cycle<2.0%.

MMBT3906

ELECTRICAL CHARACTERISTICS ($T_a=25^\circ\text{C}$ unless otherwise specified)

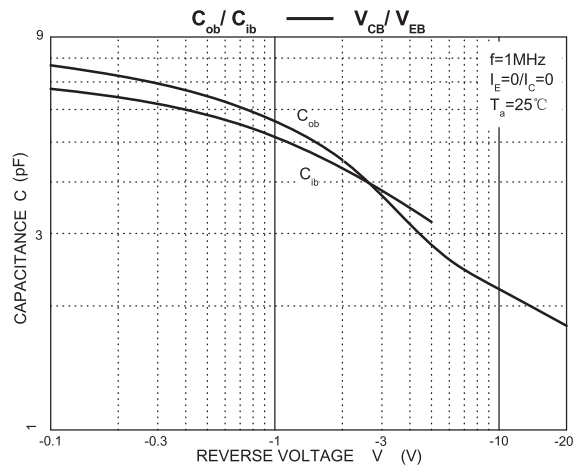
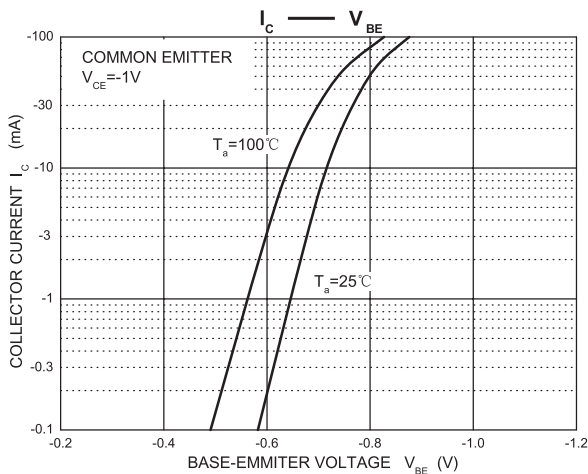
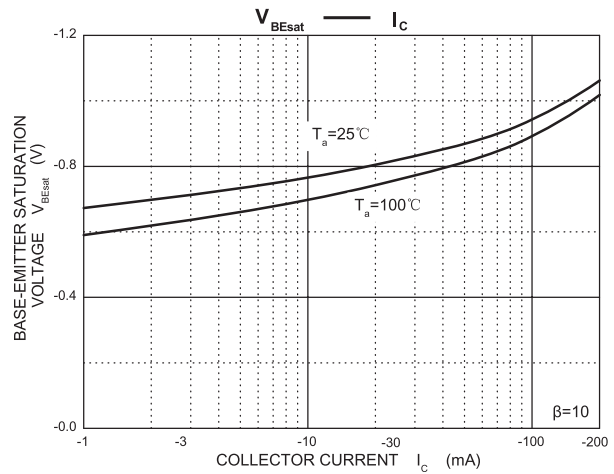
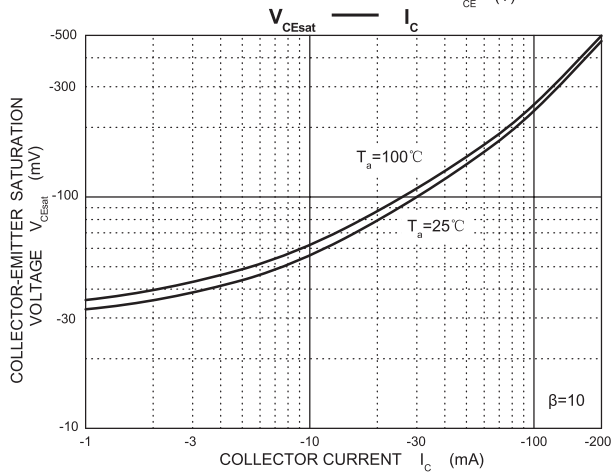
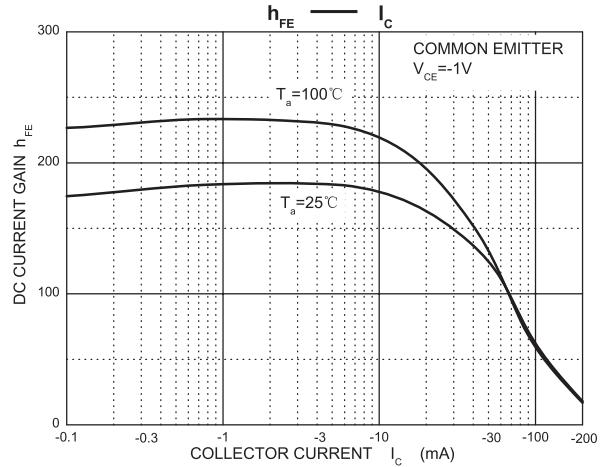
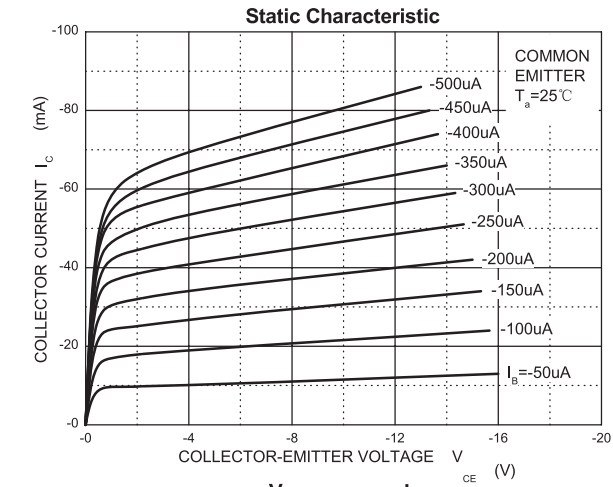

MMBT3906

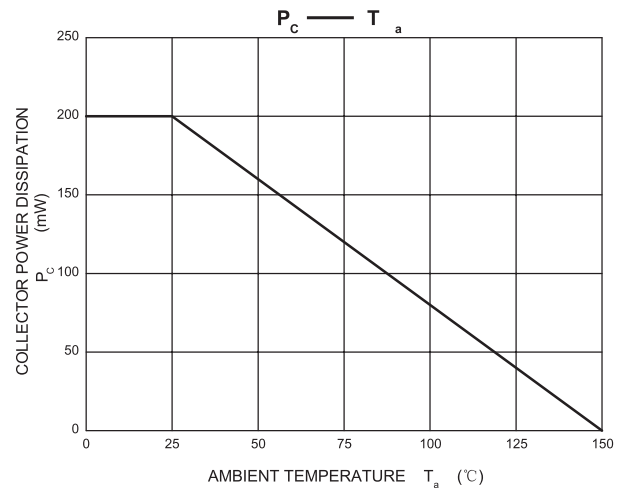
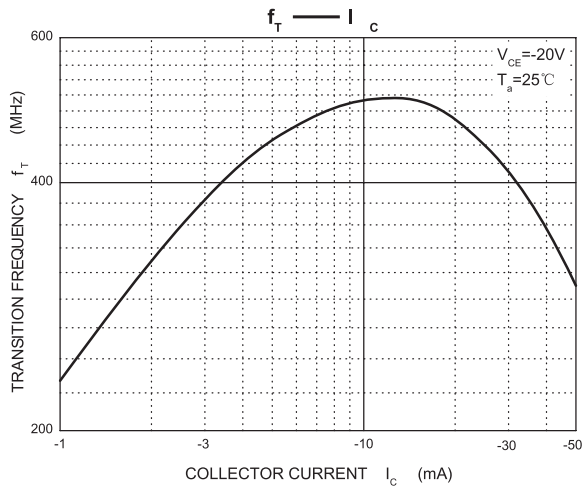

SOT-23 OUTLINE DIMENSIONS

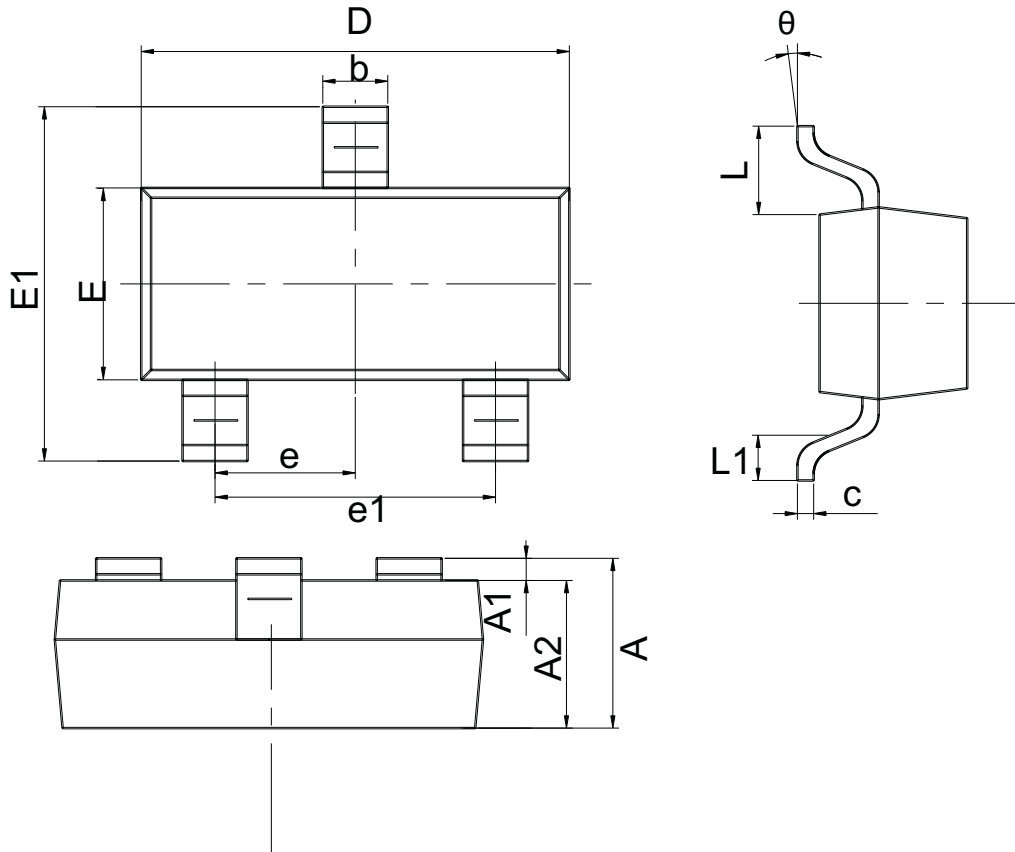

symbol	Dimensions In Millimeters		Dimensions In Inches	
	Min.	Max.	Min.	Max.
A	0.900	1.150	0.035	0.045
A1	0.000	0.100	0.000	0.004
A2	0.900	1.050	0.035	0.041
b	0.300	0.500	0.012	0.020
c	0.080	0.150	0.003	0.006
D	2.800	3.000	0.110	0.118
E	1.200	1.400	0.047	0.055
E1	2.250	2.550	0.089	0.100
e	0.950REF.		0.037REF.	
e1	1.800	2.000	0.071	0.079
L	0.550REF		0.022REF	
L1	0.300	0.500	0.012	0.020
θ	0°	8°	0°	8°

SOT-23 Tape and Reel

SOT-23 Embossed Carrier Tape

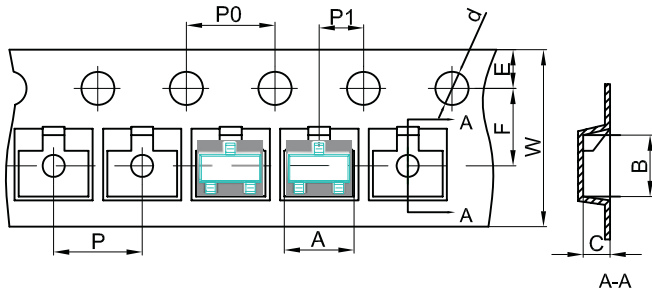

Packaging Description:

SOT-23 parts are shipped in tape. The carrier tape is made from a dissipative (carbon filled) polycarbonate resin. The cover tape is a multilayer film (Heat Activated Adhesive in nature) primarily composed of polyester film, adhesive layer, sealant, and anti-static sprayed agent. These reeled parts in standard option are shipped with 3000 units per 7" or 17.8cm diameter reel. The reels are clear in color and is made of polystyrene plastic (anti-static coated).

Dimensions are in millimeter										
Pkg type	A	B	C	d	E	F	P0	P	P1	W
SOT-23	3.15	2.77	1.22	Ø1.50	1.75	3.50	4.00	4.00	2.00	8.00
(Tolerance)	+/-0.1	+/-0.1	+/-0.1	+/-0.1	+/-0.1	+/-0.1	+/-0.1	+/-0.1	+/-0.1	+0.3/-0.1

SOT-23 Tape Leader and Trailer

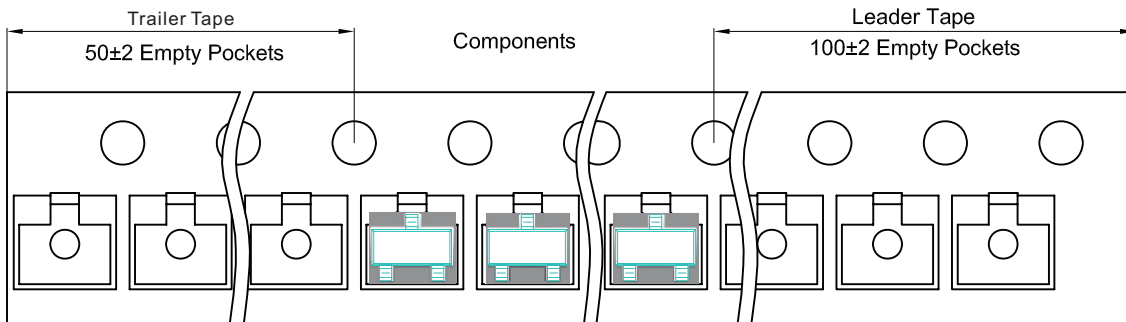

SOT-23 Reel

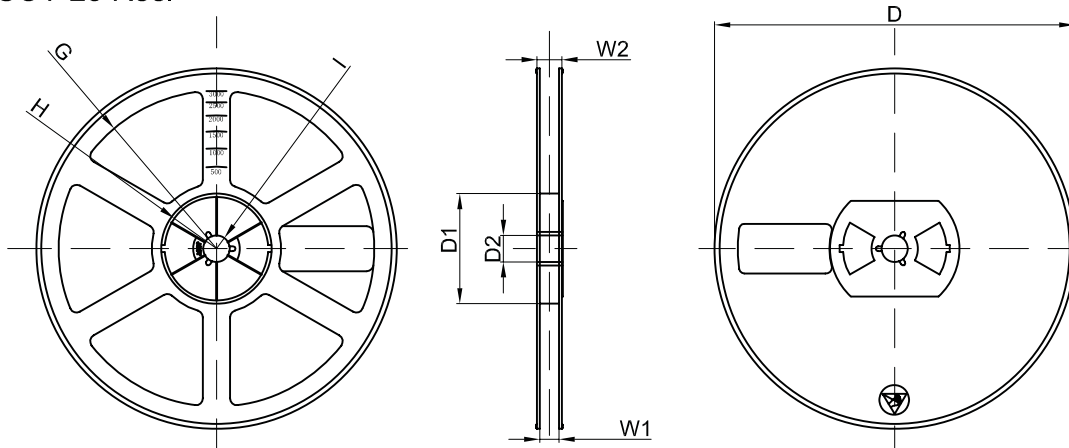

Dimensions are in millimeter								
Reel Option	D	D1	D2	G	H	I	W1	W2
7" Dia	Ø178.00	54.40	13.00	R78.00	R25.60	R6.50	9.50	12.30
Tolerance	+/-2	+/-1	+/-1	+/-1	+/-1	+/-1	+/-1	+/-1

REEL	Reel Size	Box	Box Size(mm)	Carton	Carton Size(mm)	G.W.(kg)
3000 pcs	7 inch	45,000 pcs	210x208x203	180,000 pcs	440x440x230	8.45

SOT-23 Pad size

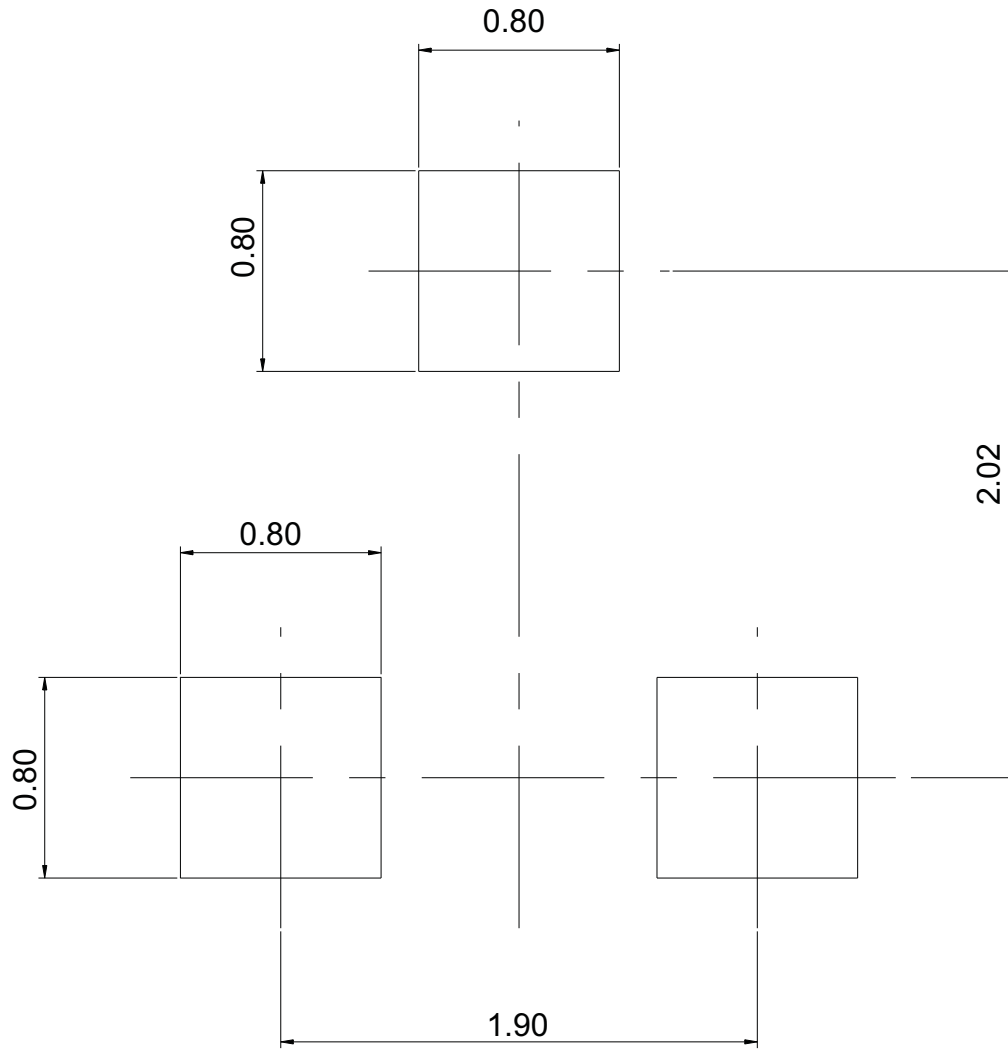

Center distance		1.90
Lead size	Lead width	0.40
	Lead length	0.55
Pad size	Pad width	0.80
	Pad length	0.80

Unit: mm