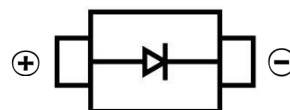

SCHOTTKY BARRIER DIODE
FEATURES

- Small Surface Mount device
- Low power loss, high efficiency
- High forward surge current capability
- For use in low voltage, high frequency inverters, free wheeling, and polarity protection applications

SMA
MECHANICAL DATA

- Case: SMA(DO-214AC)
- Case Material: Molded Plastic. UL flammability
- Classification Rating: 94V-0
- Weight: 0.065 grams (approximate)

MAXIMUM RATINGS AND ELECTRICAL CHARACTERISTICS(T_A = 25°C unless otherwise noted)

	Symbol	SK12 (SS12)	SK13 (SS13)	SK14 (SS14)	SK15 (SS15)	SK16 (SS16)	SK18 (SS18)	SK110 (SS110)	UNIT
Maximum repetitive peak reverse voltage	V _{RRM}	20	30	40	50	60	80	100	V
Maximum RMS voltage	V _{RMS}	14	21	28	35	42	56	70	V
Maximum DC blocking voltage	V _{DC}	20	30	40	50	60	80	100	V
Maximum average forward rectified current	I _{F(AV)}	1							A
Peak forward surge current 8.3 ms single half sine-wave superimposed on rated load	I _{FSM}	30							A
Maximum instantaneous forward voltage at 1.0A	V _F	0.55		0.70		0.85		V	
Maximum DC reverse current at Rated DC blocking voltage	I _R	0.5							mA
		5							mA
Voltage rate of change (rated VR)	dv/dt	10000							V/μs
Thermal resistance from junction to ambient	R _{θJA}	88							°C/W
Operating junction and storage temperature range	T _J , T _{STG}	- 65 to +150							°C

SCHOTTKY BARRIER DIODE

Typical Characteristics

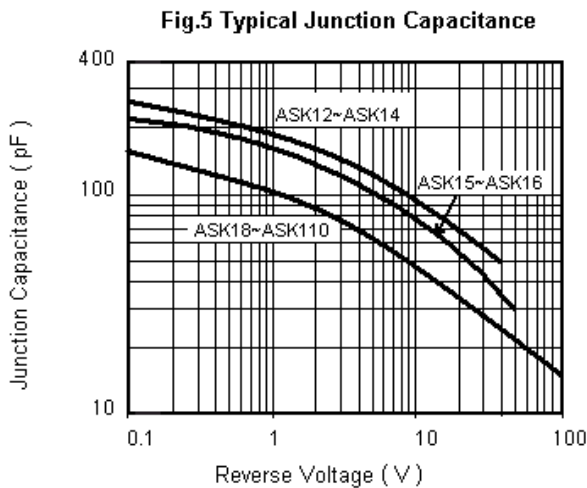
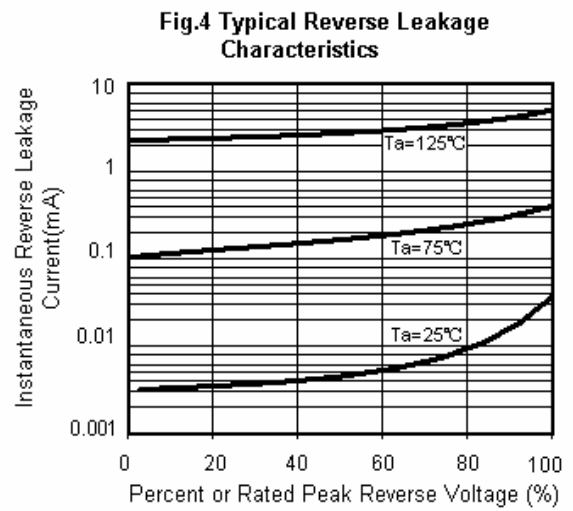
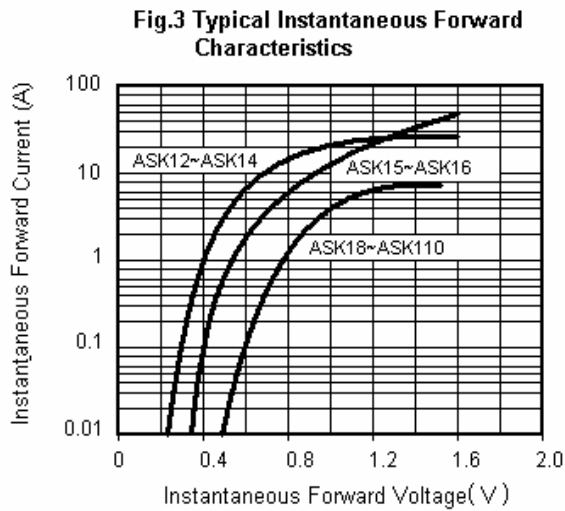
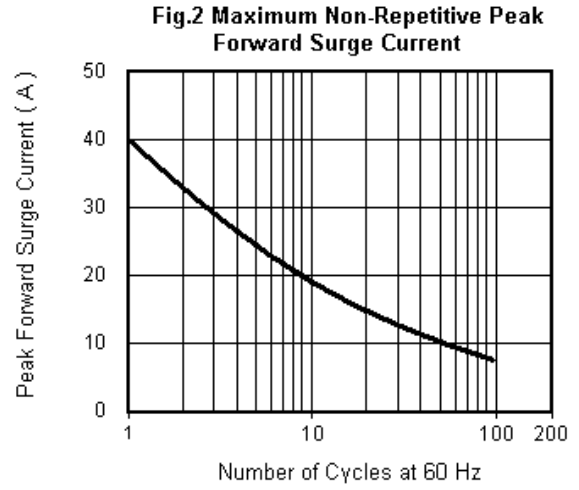
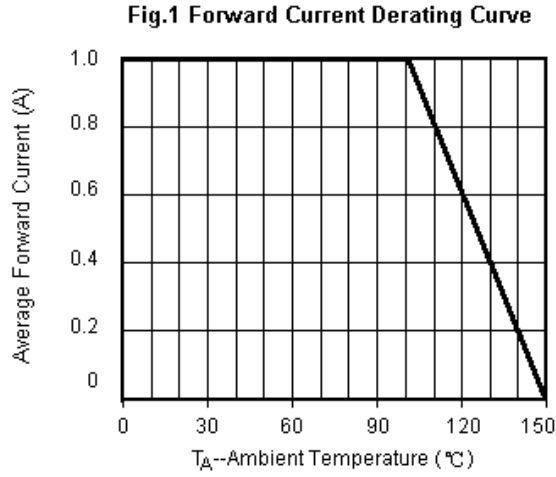

SCHOTTKY BARRIER DIODE

SMA Package Outline Dimensions

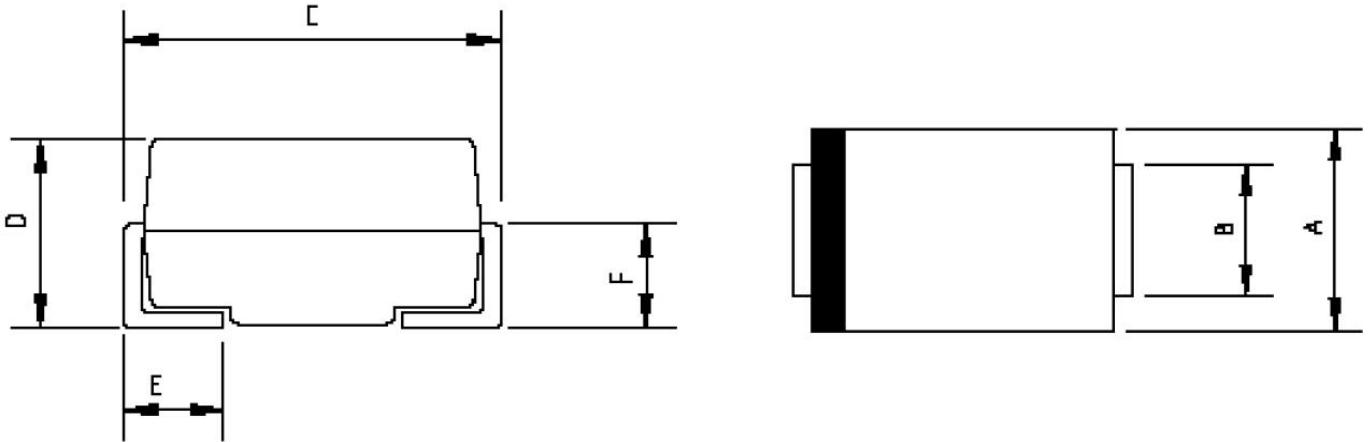

Symbol	Dimensions In Millimeters		Dimensions In Inches	
	Min.	Max.	Min.	Max.
A	2.20	2.80	0.086	0.110
B	1.30	1.70	0.051	0.067
C	4.70	5.30	0.185	0.209
D	1.70	2.55	0.067	0.100
E	0.90	1.50	0.035	0.059
F	0.90	1.50	0.035	0.059

SMA Suggested Pad Layout

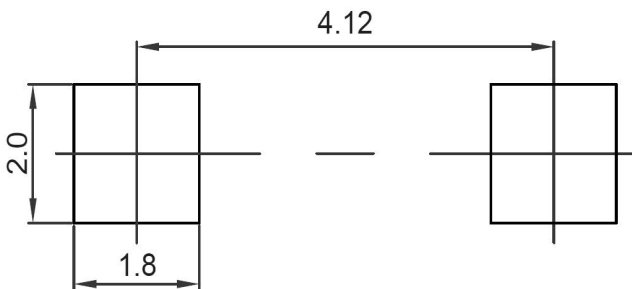

Note:

1. Controlling dimension: in millimeters
2. General tolerance: $\pm 0.05\text{mm}$
3. The pad layout is for reference purposes only

SCHOTTKY BARRIER DIODE

SMA Tape and Reel

SMA Embossed Carrier Tape

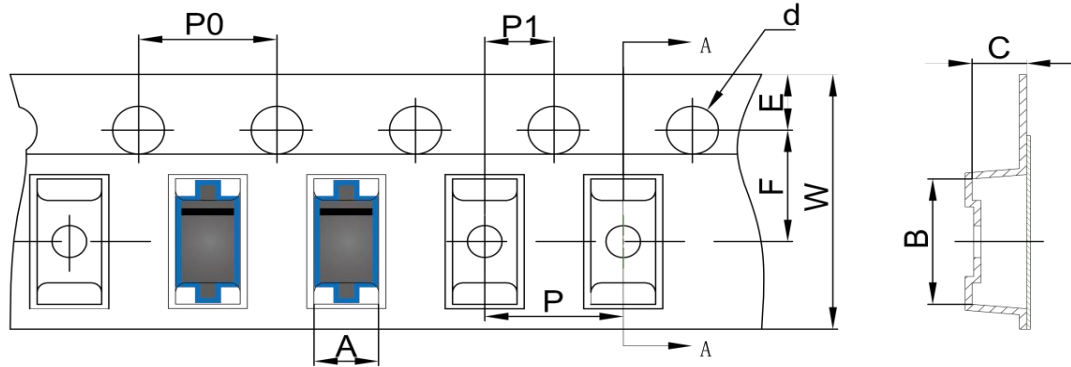

DIMENSIONS ARE IN MILLIMETER										
TYPE	A	B	C	d	E	F	P0	P	P1	W
SMA	2.89	5.35	2.68	Ø1.50	1.75	5.50	4.00	4.00	2.00	12.00
TOLERANCE	±0.1	±0.1	±0.1	±0.1	±0.1	±0.1	±0.1	±0.1	±0.1	±0.1

SMA Tape Leader and Trailer

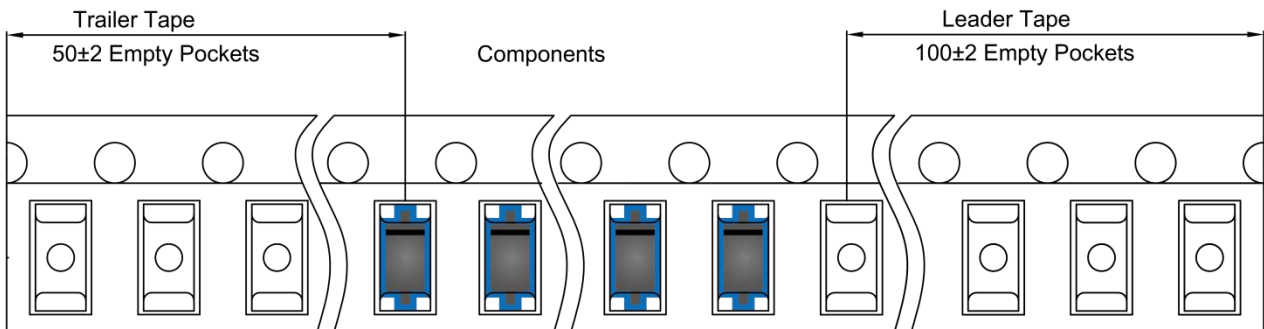

SMA Reel

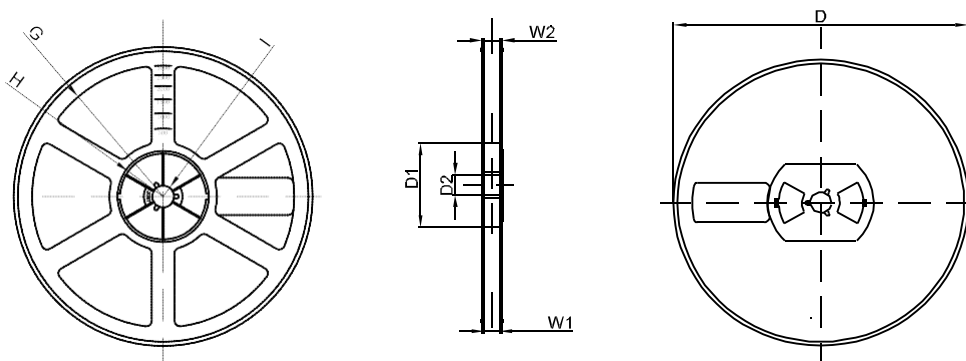

DIMENSIONS ARE IN MILLIMETER								
REEL OPTION	D	D1	D2	G	H	I	W1	W2
7" DIA	Ø178	54.40	13.00	R78	R25.60	R6.50	12.40	17.60
TOLERANCE	±2	±1	±1	±1	±1	±1	±1	±1