

BIPOLAR ANALOG INTEGRATED CIRCUIT

μ PC2933A, 2905A

THREE-TERMINAL LOW DROPOUT VOLTAGE REGULATOR

DESCRIPTION

The μ PC2933A, 2905A of low dropout voltage three terminal positive regulators is constructed with PNP output transistor. The μ PC2933A, 2905A feature the ability to source 1 A of output current with a low dropout voltage of typically 0.7 V.

The power dissipation of the μ PC2933A, 2905A can be drastically reduced compared with the conventional three terminal positive voltage regulators that is constructed with NPN output transistor. Also, this series corresponds to the low voltage output (3 V, 3.3 V) which is not in the conventional low dropout regulators (μ PC2400A series).

FEATURES

- Output current in excess of 1.0 A
- Low dropout voltage $V_{DIF} = 0.7$ V TYP. (at $I_o = 1$ A)
- On-chip overcurrent and thermal protection circuit
- On-chip output transistor safe area protection circuit

PIN CONFIGURATION (Marking Side)

μ PC2933AHF, 2905AHF : MP-45G

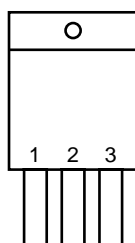

1: INPUT
2: GND
3: OUTPUT

μ PC2933AHB, 2905AHB : MP-3
 μ PC2933AT, 2905AT : MP-3Z

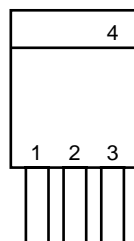

1: INPUT
2: GND
3: OUTPUT
4: GND (Fin)

The information in this document is subject to change without notice. Before using this document, please confirm that this is the latest version.
Not all devices/types available in every country. Please check with local NEC representative for availability and additional information.

BLOCK DIAGRAM

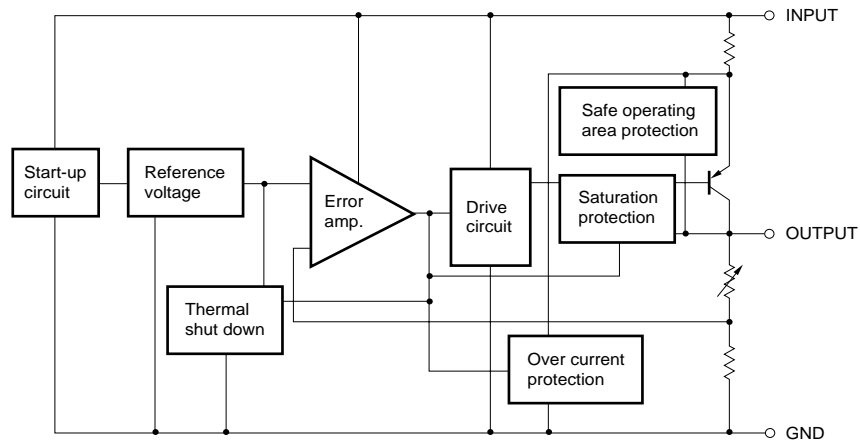

ORDERING INFORMATION

Part Number	Package	Output Voltage	Marking	Package Type
μPC2933AHF	MP-45G (Isolated TO-220)	3.3 V	2933A	<ul style="list-style-type: none"> • Packed in envelope
μPC2933AHB	MP-3 (SC-64)	3.3 V	2933A	<ul style="list-style-type: none"> • Packed in envelope
μPC2933AT	MP-3Z (SC-63)	3.3 V	2933A	<ul style="list-style-type: none"> • Packed in envelope
μPC2933AT-E1	MP-3Z (SC-63)	3.3 V	2933A	<ul style="list-style-type: none"> • 16 mm wide embossed taping • Pin 1 on drawout side • 2000 pcs/reel
μPC2933AT -E2	MP-3Z (SC-63)	3.3 V	2933A	<ul style="list-style-type: none"> • 16 mm width embossed taping • Pin 1 at takeup side • 2000 pcs/reel
μPC2933AT -T1	MP-3Z (SC-63)	3.3 V	2933A	<ul style="list-style-type: none"> • 32 mm wide adhesive taping • Pin 1 at drawout side • 1500 pcs/reel
μPC2933AT -T2	MP-3Z (SC-63)	3.3 V	2933A	<ul style="list-style-type: none"> • 32 mm wide adhesive taping • Pin 1 at takeup side • 1500 pcs/reel
μPC2905AHF	MP-45G (Isolated TO-220)	5.0 V	2905A	<ul style="list-style-type: none"> • Packed in envelope
μPC2905AHB	MP-3 (SC-64)	5.0 V	2905A	<ul style="list-style-type: none"> • Packed in envelope
μPC2905AT	MP-3Z (SC-63)	5.0 V	2905A	<ul style="list-style-type: none"> • Packed in envelope
μPC2905AT-E1	MP-3Z (SC-63)	5.0 V	2905A	<ul style="list-style-type: none"> • 16 mm wide embossed taping • Pin 1 at drawout side • 2000 pcs/reel
μPC2905AT-E2	MP-3Z (SC-63)	5.0 V	2905A	<ul style="list-style-type: none"> • 16 mm wide embossed taping • Pin 1 at takeup side • 2000 pcs/reel
μPC2905AT-T1	MP-3Z (SC-63)	5.0 V	2905A	<ul style="list-style-type: none"> • 32 mm wide adhesive taping • Pin 1 at drawout side • 1500 pcs/reel
μPC2905AT-T2	MP-3Z (SC-63)	5.0 V	2905A	<ul style="list-style-type: none"> • 32 mm wide adhesive taping • Pin 1 at takeup side • 1500 pcs/reel

ABSOLUTE MAXIMUM RATINGS (T_A = 25°C unless otherwise specified)

Parameter	Symbol	Rating		Unit
		μPC2933AHF, 2905AHF	μPC2933AHB, 2905AHB μPC2933AT, 2905AT	
Input Voltage	V _{IN}	20		V
Internal Power Dissipation ^{Note} (T _C = 25°C)	P _T	15	10	W
Operating Ambient Temperature	T _A	-30 to +85		°C
Operating Junction Temperature	T _J	-30 to +150		°C
Storage Temperature	T _{stg}	-55 to +150		°C
Thermal Resistance (junction to case)	R _{th(J-C)}	7	12.5	°C/W
Thermal Resistance (junction to ambient)	R _{th(J-A)}	65	125	°C/W

Note Internally limited. When the operating junction temperature rises over 150°C, the internal circuit shuts down the output voltage.

Caution If the absolute maximum rating of any of the above parameters is exceeded even momentarily, the quality of the product may be degraded. In other words, absolute maximum ratings specify the values exceeding which the product may be physically damaged. Be sure to use the product with these ratings never exceeded.

STANDARD CONNECTION

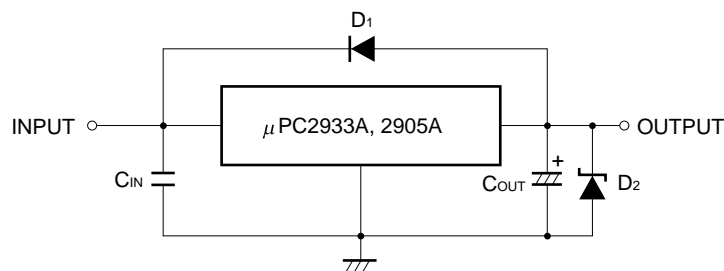

C_{IN}: 0.1 μF or higher. Set this value according to the length of the line between the regulator and INPUT pin. Be sure to connect C_{IN} to prevent parasitic oscillation. Use of a film capacitor or other capacitor with excellent voltage and temperature characteristics is recommended. If using a laminated ceramic capacitor, it is necessary to ensure that C_{IN} is 0.1 μF or higher for the voltage and temperature range to be used.

★ C_{OUT}: 47 μF or higher. Be sure to connect C_{OUT} to prevent oscillation and improve excessive load regulation. Place C_{IN} and C_{OUT} as close as possible to the IC pins (within 2 cm). Also, use an electrolytic capacitor with low impedance characteristics if considering use at sub-zero temperatures.

D₁: If the OUTPUT pin has a higher voltage than the INPUT pin, connect a diode.

D₂: If the OUTPUT pin has a lower voltage than the GND pin, connect a Schottky barrier diode.

Caution Make sure that no voltage is applied to the OUTPUT pin from external.

RECOMMENDED OPERATING CONDITIONS

Parameter	Symbol	Type Number	MIN.	TYP.	MAX.	Unit
Input Voltage	V _{IN}	μPC2933A	4.3		16	V
		μPC2905A	6		16	
Output Current	I _o	All	0		1.0	A
Operating Ambient Temperature	T _A	All	-30		+85	°C
Operating Junction Temperature	T _J	All	-30		+125	°C

ELECTRICAL CHARACTERISTICS

μPC2933A (T_J = 25°C, V_{IN} = 5 V, I_o = 500 mA, C_{IN} = 0.22 μF, C_{OUT} = 47 μF, unless otherwise specified)

Parameter	Symbol	Conditions	MIN.	TYP.	MAX.	Unit
Output Voltage	V _o		3.18	3.3	3.42	V
		0°C ≤ T _J ≤ 125°C, 4.3 V ≤ V _{IN} ≤ 16 V, 0 A ≤ I _o ≤ 500 mA	3.14		3.46	
		0°C ≤ T _J ≤ 125°C, 0 A ≤ I _o ≤ 1 A				
Line Regulation	REG _{IN}	4.3 V ≤ V _{IN} ≤ 16 V		12	33	mV
Load Regulation	REG _L	0 A ≤ I _o ≤ 1 A		23	33	
Quiescent Current	I _{BIAS}	I _o = 0 A		2.0	3.0	mA
		I _o = 1 A		20	40	
Startup Quiescent Current	I _{BIAS (s)}	V _{IN} = 3.1 V, I _o = 0 A		10	30	mA
		V _{IN} = 3.1 V, I _o = 1 A			80	
Quiescent Current Change	ΔI _{BIAS}	0°C ≤ T _J ≤ 125°C, 4.3 V ≤ V _{IN} ≤ 16 V		3.0	15	mA
Output Noise Voltage	V _n	10 Hz ≤ f ≤ 100 kHz		55		μV _{r.m.s.}
Ripple Rejection	R•R	4.3 V ≤ V _{IN} ≤ 16 V, f = 120 Hz	48	64		dB
Dropout Voltage	V _{DIF}	0°C ≤ T _J ≤ 125°C, I _o = 1 A		0.7	1.0	V
Short Circuit Current	I _{Opeak}	V _{IN} = 4.5 V	1.2	1.6	3.0	A
		V _{IN} = 16 V		1.2		
Peak Output Current	I _{Opeak}	V _{IN} = 4.5 V	1.0	1.4	3.0	A
		V _{IN} = 16 V	1.3	1.7	2.8	
Temperature Coefficient of Output Voltage	ΔV _o / ΔT	0°C ≤ T _J ≤ 125°C, I _o = 5 mA		-0.4		mV/°C

μPC2905A (T_J = 25°C, V_{IN} = 8 V, I_O = 500 mA, C_{IN} = 0.22 μF, C_{OUT} = 47 μF, unless otherwise specified)

Parameter	Symbol	Conditions	MIN.	TYP.	MAX.	Unit
Output Voltage	V _O		4.83	5.0	5.18	V
		0°C ≤ T _J ≤ 125°C, 6 V ≤ V _{IN} ≤ 16 V, 0 A ≤ I _O ≤ 500 mA	4.75		5.25	
		0°C ≤ T _J ≤ 125°C, 0 A ≤ I _O ≤ 1 A				
Line Regulation	REG _{IN}	6 V ≤ V _{IN} ≤ 16 V		23	50	mV
Load Regulation	REG _L	0 A ≤ I _O ≤ 1 A		28	50	mV
Quiescent Current	I _{BIAS}	I _O = 0 A		2.2	3.5	mA
		I _O = 1 A		28	50	
Startup Quiescent Current	I _{BIAS (s)}	V _{IN} = 4.5 V, I _O = 0 A		10	30	mA
		V _{IN} = 4.5 V, I _O = 1 A			50	
Quiescent Current Change	ΔI _{BIAS}	0°C ≤ T _J ≤ 125°C, 6 V ≤ V _{IN} ≤ 16 V		2.9	15	mA
Output Noise Voltage	V _n	10 Hz ≤ f ≤ 100 kHz		90		μV _{r.m.s.}
Ripple Rejection	R•R	f = 120 Hz, 6 V ≤ V _{IN} ≤ 16 V	46	61		dB
Dropout Voltage	V _{DIF}	0°C ≤ T _J ≤ 125°C, I _O = 1 A		0.7	1.0	V
Short Circuit Current	I _{Opeak}	V _{IN} = 6.5 V	1.15	1.8	3.0	A
		V _{IN} = 16 V		1.1		
Peak Output Current	I _{Opeak}	V _{IN} = 6.5 V	1.1	1.5	3.0	A
		V _{IN} = 16 V	1.4	2.0	2.8	
Temperature Coefficient of Output Voltage	ΔV _O / ΔT	0°C ≤ T _J ≤ 125°C, I _O = 5 mA		0.6		mV/°C

TYPICAL CHARACTERISTICS (Reference Values)

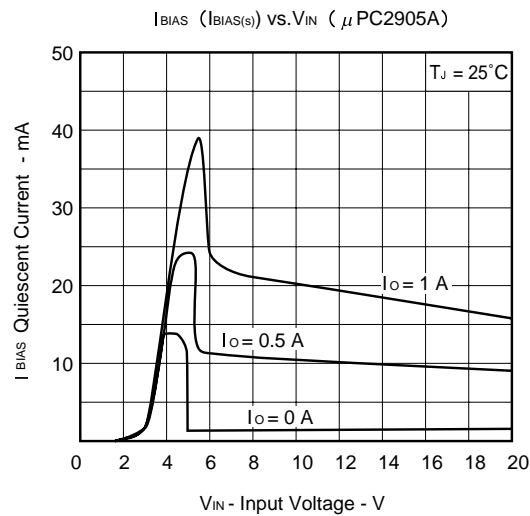
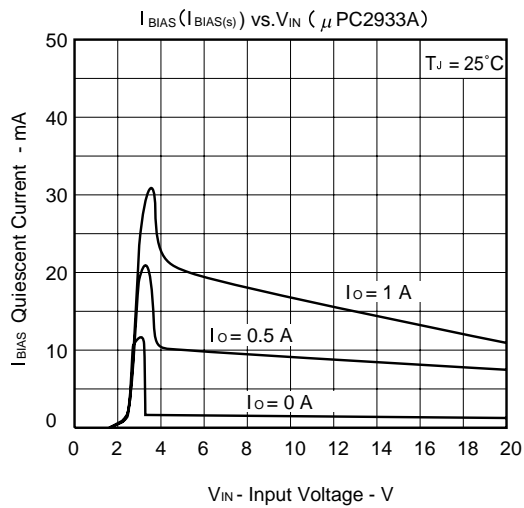
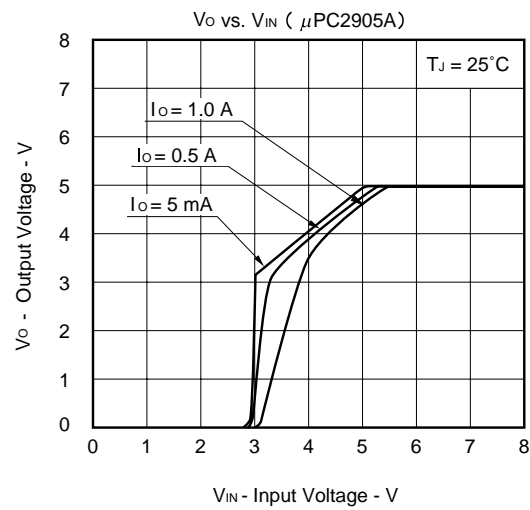
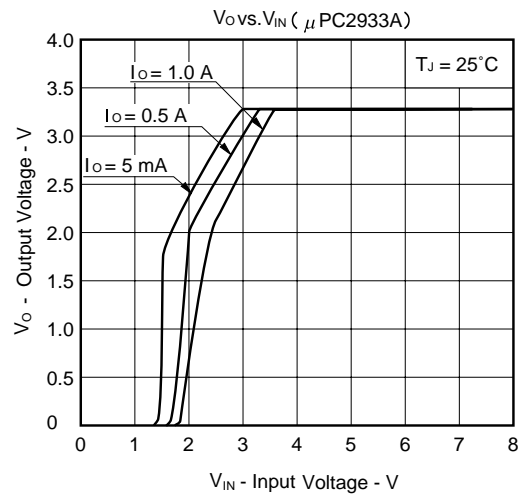
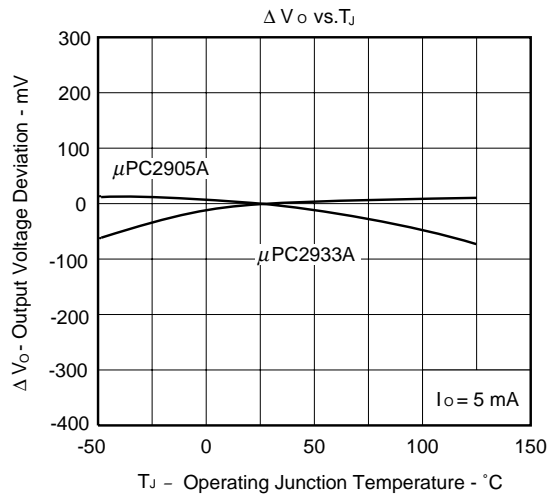
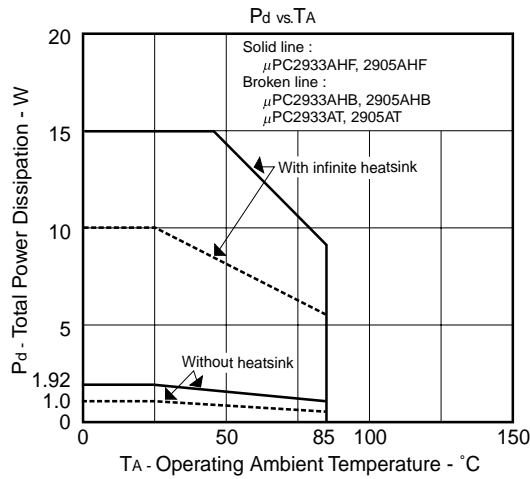

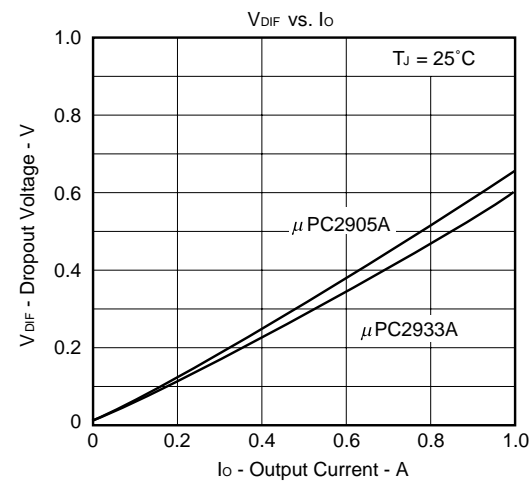
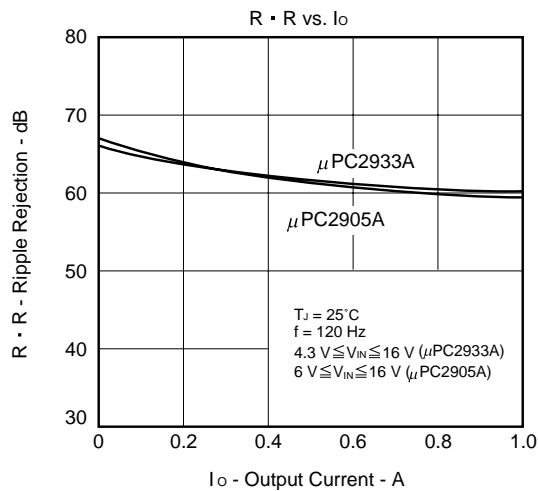
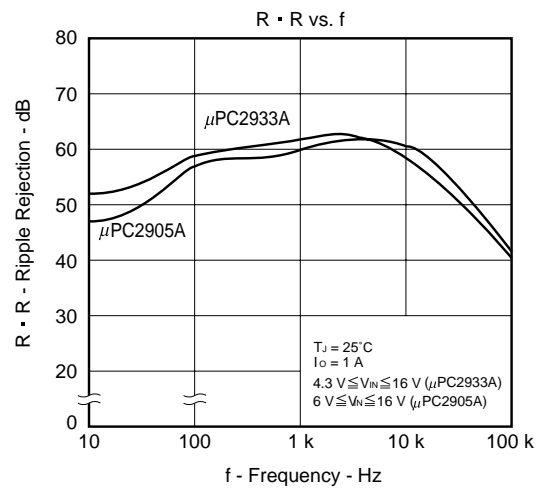
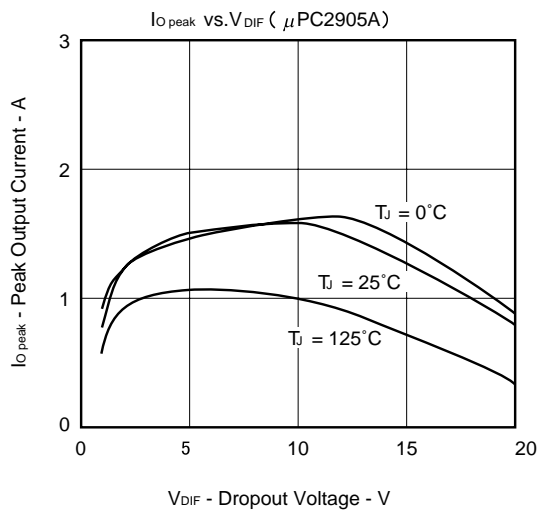
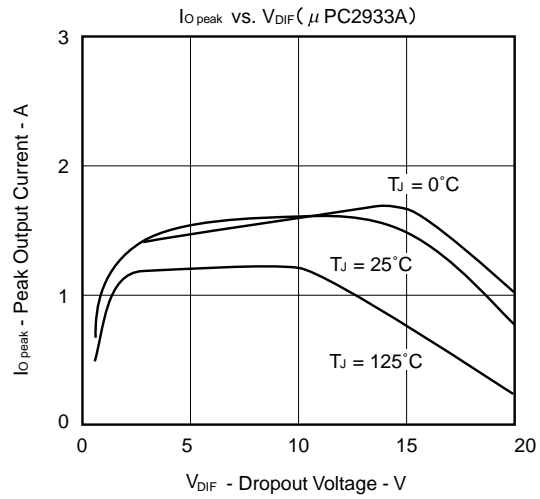
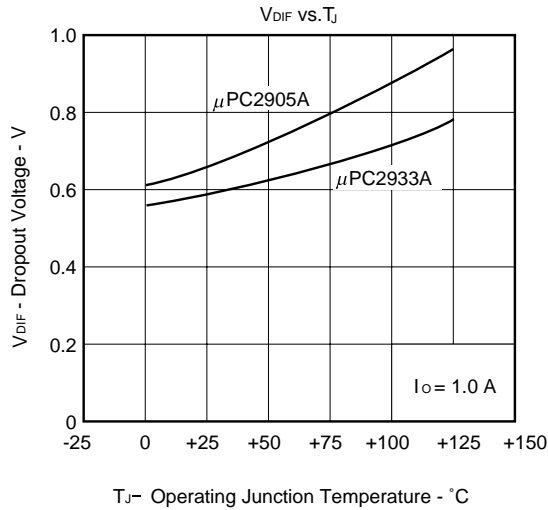

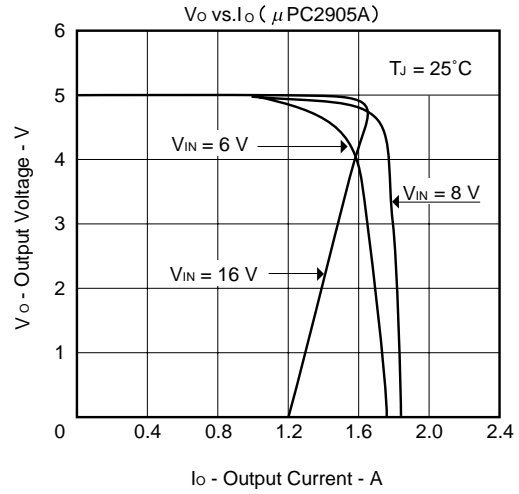
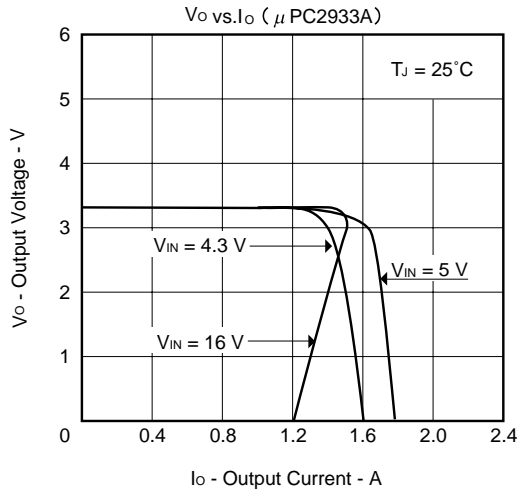

PACKAGE DRAWINGS

μPC2933AHF, 2905AHF

3PIN PLASTIC SIP (MP-45G)

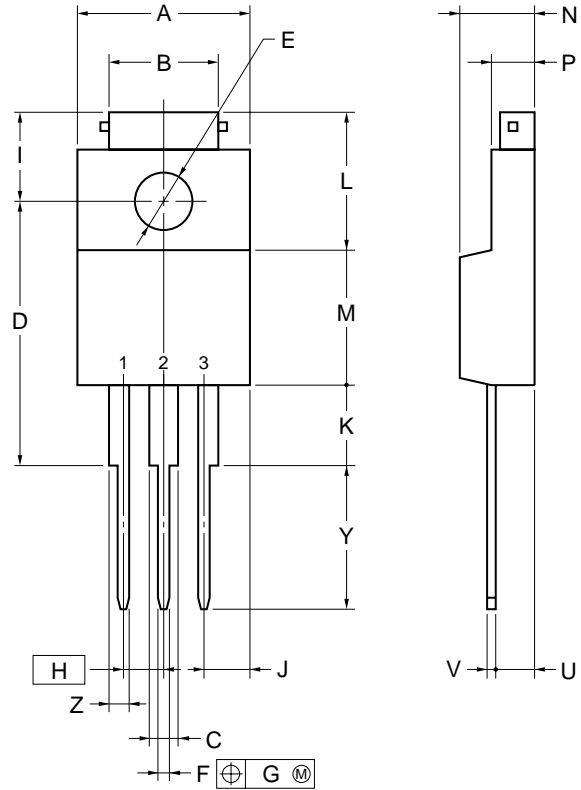

NOTE
 Each lead centerline is located within 0.25 mm of its true position (T.P.) at maximum material condition.

ITEM	MILLIMETERS
A	10.0±0.2
B	7.0±0.2
C	1.50±0.2
D	17.0±0.3
E	∅3.3±0.2
F	0.75±0.10
G	0.25
H	2.54 (T.P.)
I	5.0±0.3
J	2.46±0.2
K	5.0±0.2
L	8.5±0.2
M	8.5±0.2
N	4.5±0.2
P	2.8±0.2
U	2.4±0.5
V	0.65±0.10
Y	8.9±0.7
Z	1.30±0.2

P3HF-254B-4

μPC2933AHB, 2905AHB

MP-3(SC-64) (Unit: mm)

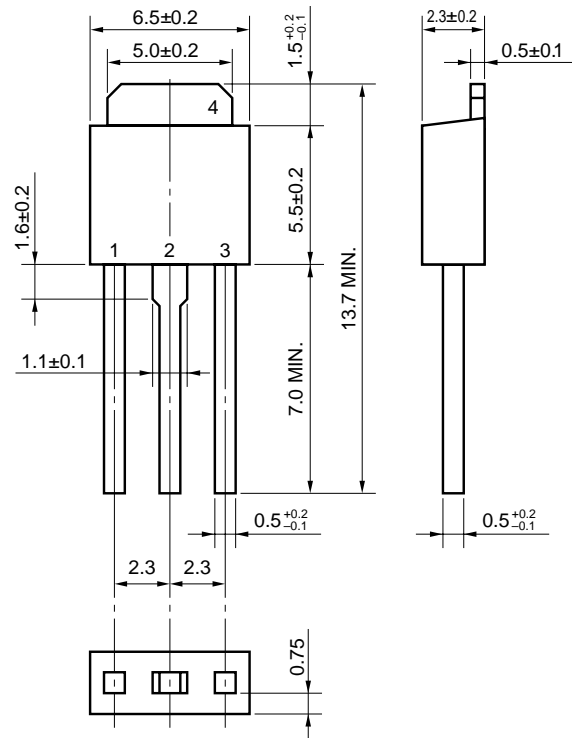

μPC2933AT, 2905AT

MP-3Z (SC-63) (Unit: mm)

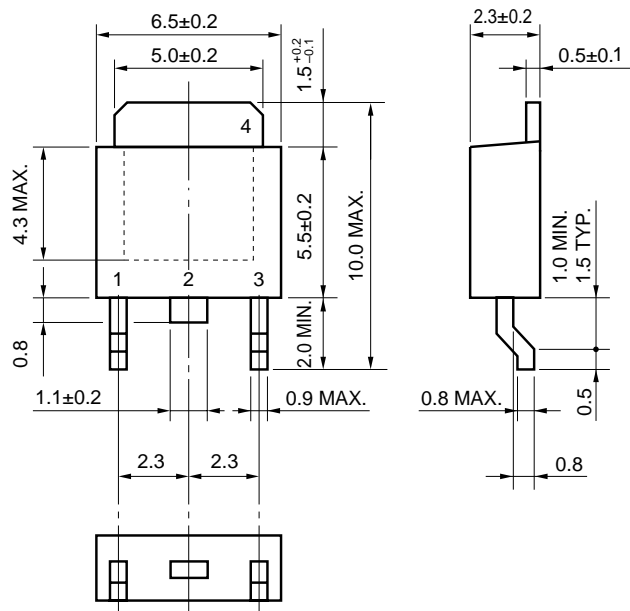

RECOMMENDED SOLDERING CONDITIONS

When soldering this product, it is highly recommended to observe the conditions as shown below. If other soldering processes are used, or if the soldering is performed under different condition, please make sure to consult with our sales offices.

For more details, refer to our document “SEMICONDUCTOR DEVICE MOUNTING TECHNOLOGY MANUAL” (C10535E).

Surface Mount Device

μPC2933AT, 2905AT: MP-3Z (SC-63)

Process	Conditions	Symbol
Infrared Ray Reflow	Peak temperature: 235°C or below (Package surface temperature), Reflow time: 30 seconds or less (at 210°C or higher), Maximum number of reflow processes: 2 times or less.	IR35-00-2
Vapor Phase Soldering	Peak temperature: 215°C or below (Package surface temperature), Reflow time: 40 seconds or less (at 200°C or higher), Maximum number of reflow processes: 2 times or less.	VP15-00-2
Wave Soldering	Solder temperature: 260°C or below, Flow time: 10 seconds or less, Maximum number of flow processes: 1 time, Pre-heating temperature: 120°C or below (Package surface temperature).	WS60-00-1
Partial Heating Method	Pin temperature: 300°C or below, Heat time: 3 seconds or less (Per each side of the device).	—

Caution Apply only one kind of soldering condition to a device, except for "partial heating method", or the device will be damaged by heat stress.

Through-hole devices

μPC2933AHF, 2905AHF: MP-45G

μPC2933AHB, 2905AHB: MP-3

Process	Conditions
Wave soldering (only to leads)	Solder temperature: 260°C or below, Flow time: 10 seconds or less.
Partial heating method	Pin temperature: 300°C or below, Heat time: 3 seconds or less (Per each pin).

Caution For through-hole device, the wave soldering process must be applied only to leads, and make sure that the package body does not get jet soldered.

NOTES ON USE

When the μPC2933A, 2905A are used with an input voltage that is lower than the value indicated in the recommended operating conditions, a large quiescent current flows through the device due to saturation of the transistor of the output stage. (Refer to the I_{BIAS} (I_{BIAS(S)}) vs. V_{IN} curves in **TYPICAL CHARACTERISTICS**).

These products have saturation protector, but a current of up to 80 mA MAX. may flow through the device. Thus the power supply on the input side must have sufficient capacity to allow this quiescent current to pass when the device starts up.

REFERENCE DOCUMENTS

Document Name	Document No.
QUALITY GRADES ON NEC SEMICONDUCTOR DEVICES	C11531E
SEMICONDUCTOR DEVICE MOUNTING TECHNOLOGY MANUAL	C10535E
VOLTAGE REGULATOR OF SMD	G11872E
SEMICONDUCTOR SELECTION GUIDE – PRODUCTS AND PACKAGES	X13769E

[MEMO]

[MEMO]

- **The information in this document is current as of September, 2001. The information is subject to change without notice. For actual design-in, refer to the latest publications of NEC's data sheets or data books, etc., for the most up-to-date specifications of NEC semiconductor products. Not all products and/or types are available in every country. Please check with an NEC sales representative for availability and additional information.**
 - No part of this document may be copied or reproduced in any form or by any means without prior written consent of NEC. NEC assumes no responsibility for any errors that may appear in this document.
 - NEC does not assume any liability for infringement of patents, copyrights or other intellectual property rights of third parties by or arising from the use of NEC semiconductor products listed in this document or any other liability arising from the use of such products. No license, express, implied or otherwise, is granted under any patents, copyrights or other intellectual property rights of NEC or others.
 - Descriptions of circuits, software and other related information in this document are provided for illustrative purposes in semiconductor product operation and application examples. The incorporation of these circuits, software and information in the design of customer's equipment shall be done under the full responsibility of customer. NEC assumes no responsibility for any losses incurred by customers or third parties arising from the use of these circuits, software and information.
 - While NEC endeavours to enhance the quality, reliability and safety of NEC semiconductor products, customers agree and acknowledge that the possibility of defects thereof cannot be eliminated entirely. To minimize risks of damage to property or injury (including death) to persons arising from defects in NEC semiconductor products, customers must incorporate sufficient safety measures in their design, such as redundancy, fire-containment, and anti-failure features.
 - NEC semiconductor products are classified into the following three quality grades:
"Standard", "Special" and "Specific". The "Specific" quality grade applies only to semiconductor products developed based on a customer-designated "quality assurance program" for a specific application. The recommended applications of a semiconductor product depend on its quality grade, as indicated below. Customers must check the quality grade of each semiconductor product before using it in a particular application.
"Standard": Computers, office equipment, communications equipment, test and measurement equipment, audio and visual equipment, home electronic appliances, machine tools, personal electronic equipment and industrial robots
"Special": Transportation equipment (automobiles, trains, ships, etc.), traffic control systems, anti-disaster systems, anti-crime systems, safety equipment and medical equipment (not specifically designed for life support)
"Specific": Aircraft, aerospace equipment, submersible repeaters, nuclear reactor control systems, life support systems and medical equipment for life support, etc.
- The quality grade of NEC semiconductor products is "Standard" unless otherwise expressly specified in NEC's data sheets or data books, etc. If customers wish to use NEC semiconductor products in applications not intended by NEC, they must contact an NEC sales representative in advance to determine NEC's willingness to support a given application.
- (Note)
- (1) "NEC" as used in this statement means NEC Corporation and also includes its majority-owned subsidiaries.
(2) "NEC semiconductor products" means any semiconductor product developed or manufactured by or for NEC (as defined above).