

PLEASE CHECK WWW.MOLEX.COM FOR LATEST PART INFORMATION

Part Number: [0879140009](#)
Status: **Active**
Overview: [cgrid_sl_products](#)
Description: 2.54mm (.100") Pitch C-Grid® Header, Through Hole, Dual Row, Vertical, 6 Circuits, Gold (Au) Flash Overall Plating, Tray Packaging, Lead-free

Documents:

[3D Model](#) [Product Specification PS-87920-019 \(PDF\)](#)
[Drawing \(PDF\)](#) [RoHS Certificate of Compliance \(PDF\)](#)

Agency Certification

UL E29179

General

Product Family PCB Headers
 Series [87914](#)
 Application Board-to-Board, Wire-to-Board
 Overview [cgrid_sl_products](#)
 Product Name C-Grid®

Physical

Breakaway Yes
 Circuits (Loaded) 6
 Circuits (maximum) 6
 Color - Resin Black
 First Mate / Last Break No
 Flammability 94V-0
 Glow-Wire Compliant No
 Guide to Mating Part No
 Keying to Mating Part None
 Lock to Mating Part None
 Mated Height (in) 0.522 In
 Mated Height (mm) 13.25 mm
 Material - Metal Copper Alloy
 Material - Plating Mating Gold
 Material - Plating Termination Gold
 Material - Resin High Temperature Thermoplastic
 Number of Rows 2
 Orientation Vertical
 PC Tail Length (in) 0.130 In
 PC Tail Length (mm) 3.30 mm
 PCB Locator No
 PCB Retention None
 PCB Thickness Recommended (in) 0.062 In
 PCB Thickness Recommended (mm) 1.60 mm
 Packaging Type Tray
 Pitch - Mating Interface (in) 0.100 In
 Pitch - Mating Interface (mm) 2.54 mm
 Pitch - Term. Interface (in) 0.100 In
 Pitch - Term. Interface (mm) 2.54 mm
 Plating min: Mating (µin) 1
 Plating min: Mating (µm) 0.025
 Plating min: Termination (µin) 50
 Plating min: Termination (µm) 1.27
 Polarized to Mating Part No
 Polarized to PCB No

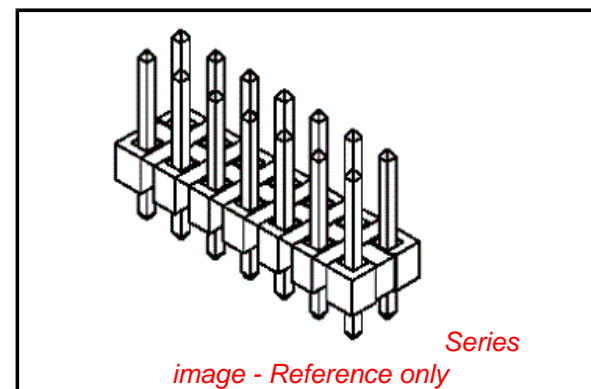

EU RoHS

ELV and RoHS Compliant
REACH SVHC
 Not Reviewed
Halogen-Free Status
Not Reviewed

China RoHS



Need more information on product environmental compliance?

Email productcompliance@molex.com
 For a multiple part number RoHS Certificate of Compliance, [click here](#)

Please visit the [Contact Us](#) section for any non-product compliance questions.

Search Parts in this Series

[87914Series](#)

Mates With

7859 Shunts. C-Grid® PCB Receptacles like 71850. [SL™](#) IDT Housing like 70450

| | |
|--------------------------------|-----------------|
| Shrouded | No |
| Stackable | No |
| Surface Mount Compatible (SMC) | Yes |
| Temperature Range - Operating | -55°C to +105°C |
| Termination Interface: Style | Through Hole |

Electrical

| | |
|-------------------------------|------|
| Current - Maximum per Contact | 3A |
| Voltage - Maximum | 250V |

Solder Process Data

| | |
|--|------------------------|
| Duration at Max. Process Temperature (seconds) | 12 |
| Lead-free Process Capability | Wave Capable (TH only) |
| Max. Cycles at Max. Process Temperature | 1 |
| Process Temperature max. C | 260 |

Material Info

Reference - Drawing Numbers

| | |
|-----------------------|--------------|
| Product Specification | PS-87920-019 |
| Sales Drawing | SD-87914-013 |

This document was generated on 05/25/2010

PLEASE CHECK WWW.MOLEX.COM FOR LATEST PART INFORMATION

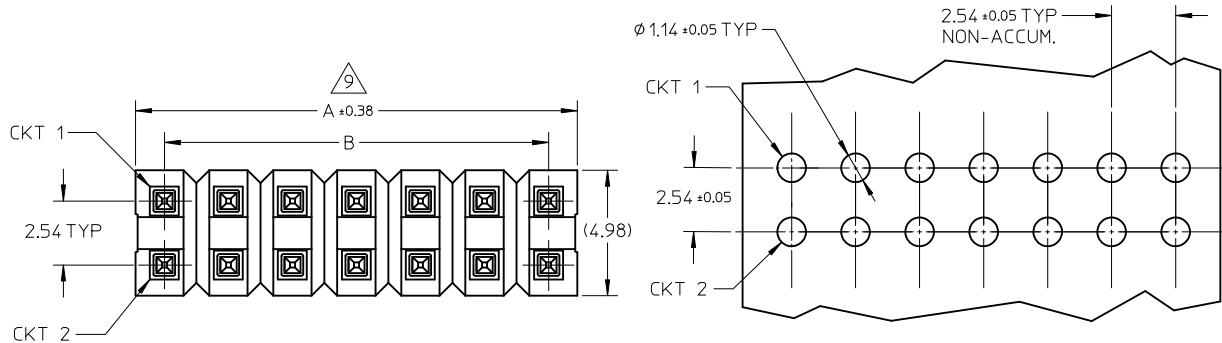

RECOMMENDED P.C.B HOLE LAYOUT

NOTES:

1. MATERIAL:
 - HSG: LCP, GLASS-FILLED, UL94V-0, COLOR: BLACK
 - PIN: 0.64MM SQ PIN, COPPER ALLOY
2. PLATING TYPE:
 - (1) : GOLD FLASH OVER
1.25 MICRO METER MIN. NICKEL OVERALL.
 - (2) : 0.025 μm MIN. GOLD PLATE ON CONTACT AND 1.88 μm MIN. TIN ON SOLDERTAIL OVER 1.25 μm MIN. NICKEL OVERALL.
 - (3) : 0.25 μm MIN. GOLD PLATE ON CONTACT AND 1.88 μm MIN. TIN ON SOLDERTAIL OVER 1.25 μm MIN. NICKEL OVERALL.
 - (4) : 0.38 μm MIN. GOLD PLATE ON CONTACT AND 1.88 μm MIN. TIN ON SOLDERTAIL OVER 1.25 μm MIN. NICKEL OVERALL.
 - (5) : 0.75 μm MIN. GOLD PLATE ON CONTACT AND 1.88 μm MIN. TIN ON SOLDERTAIL OVER 1.25 μm MIN. NICKEL OVERALL
 - (6) : 2.50 μm MIN. TIN IN SELECTED AREA OVER 1.25 μm MIN. NICKEL OVERALL.
 - (7) : 0.38 μm MIN. GOLD PLATE ON CONTACT AND 2.50 μm MIN. TIN ON SOLDERTAIL OVER 1.25 μm MIN. NICKEL OVERALL.
 - (8) : 0.38 μm MIN. GOLD PLATE ON CONTACT AND 0.05 μm MIN. GOLD FLASH ON SOLDERTAIL OVER 1.25 μm MIN. NICKEL OVERALL.
3. PIN PUSHOUT FORCE: 1KG MIN IN EITHER DIRECTION
4. THE ABOVE 14 CKT IS FOR ILLUSTRATION PURPOSE ONLY.
5. FOR PACKAGING OPTION PLEASE REFER TO THE TABLE.
6. RECOMMENDED PCB THICKNESS 1.60MM.
7. PRODUCT SPECIFICATION: PS-87920-019
8. WAFER TO BE FLAT WITHIN 0.003mm/mm
9. IRREGULAR CIRCUIT CUTOFF WITHIN BREAKAWAY SECTION IS PERMISSIBLE. CUTTING OR CHIPPING OF THE MAIN BODY IS NOT ACCEPTABLE.
10. PARTS ARE NOT STACKABLE ON 2.54 CENTER
11. CAP TO BE PLACED AS CENTRAL OF PART AS POSSIBLE WITH THE TOP SURFACE FLAT FOR PICK AND PLACE.
12. PACKAGING SPECIFICATION:
 - TRAY: PK-89990-489
 - BULK: PK-89990-491

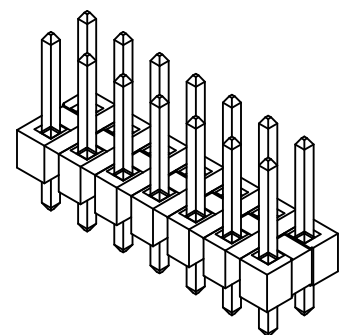
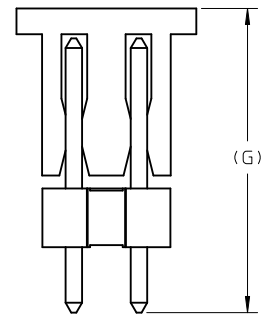
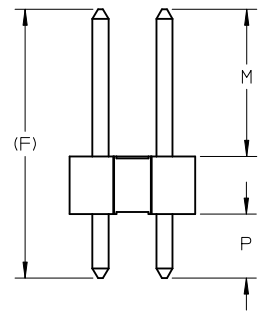
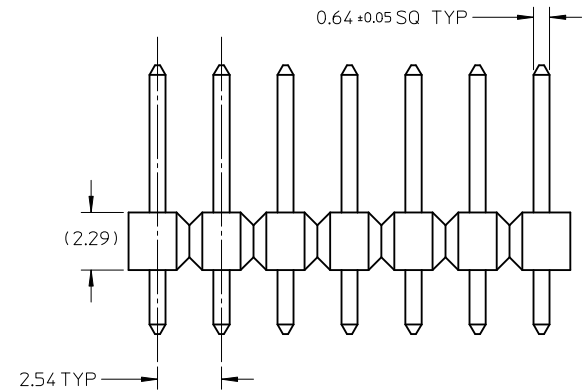

| | | | | | | | | | | |
|--|---|---------------------------------------|--------------|---|--------------------|---|------------------------------|------------------------|--|--|
| PG8. +879140108 EC NO: S2010-0695 DRW:ATSEE 2010/02/11 CHKD:PTLIM 2004/12/08 APPR:MLONG 2010/06/05 REV D7 | QUALITY SYMBOLS $\nabla_A = 0$ $\nabla_C = 0$ $\nabla_P = 0$ | GENERAL TOLERANCES (UNLESS SPECIFIED) | | DIMENSION STYLE MM ONLY | | SCALE NTS | DESIGN UNITS METRIC | THIRD ANGLE PROJECTION | | |
| | | 4 PLACES ± --- ± --- | mm INCH | DRAWN BY KCHO | DATE 2004/11/05 | TITLE 2.54MM PITCH DUAL ROW HEADER SINGLE WAFER, T/H | | | | |
| | | 3 PLACES ± --- ± --- | ± 0.20 ± --- | CHECKED BY PTLIM | DATE 2004/12/08 | MOLEX INCORPORATED | | | | |
| | | 2 PLACES ± --- ± --- | ± --- ± --- | APPROVED BY SCLOW | DATE 2004/12/10 | MATERIAL NO. SEE TABLE | DOCUMENT NO. SD-87914-013 | SHEET NO. 1 OF 46 | | |
| 1 PLACE ± --- ± --- | | ANGULAR ± 3 ° | | DRAFT WHERE APPLICABLE MUST REMAIN WITHIN DIMENSIONS | | THIS DRAWING CONTAINS INFORMATION THAT IS PROPRIETARY TO MOLEX INCORPORATED AND SHOULD NOT BE USED WITHOUT WRITTEN PERMISSION | | | | |

| P/N | CKT SIZE | F | So | W | QTY/ REEL |
|------------|----------|-------|----|-------|-----------|
| 87914-0627 | 06 | 11.50 | - | 24.00 | 250 |
| 87914-0827 | 08 | 11.50 | - | 24.00 | 250 |

FOR TAPE WIDTH WITH SINGLE ROW SPROCKET HOLES.

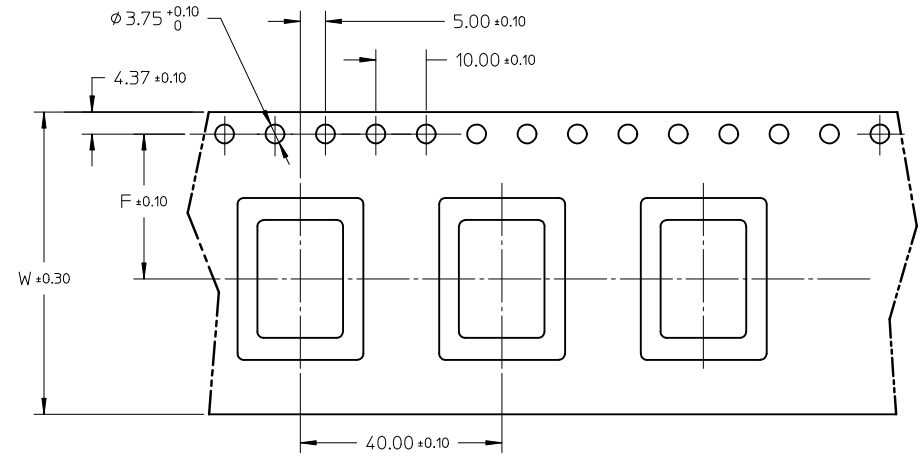

CUSTOMER
PULL OUT DIRECTION

FOR TAPE WIDTH WITH 2 ROWS OF SPROCKET HOLES.

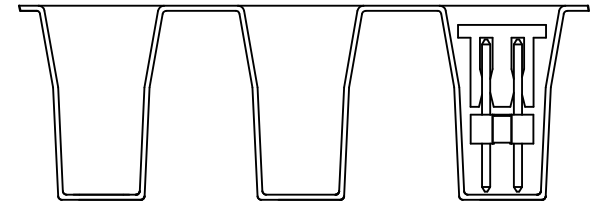
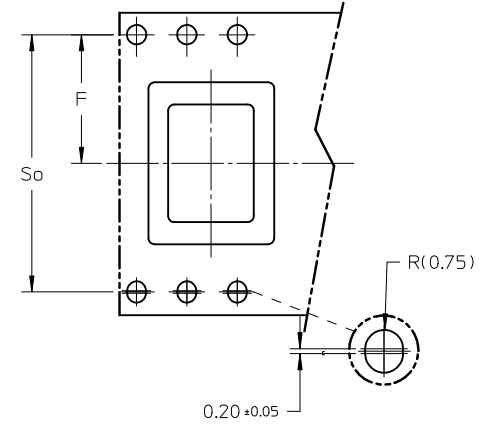

VIEW OF PART ORIENTATION
IN TAPE & REEL

NOTES:

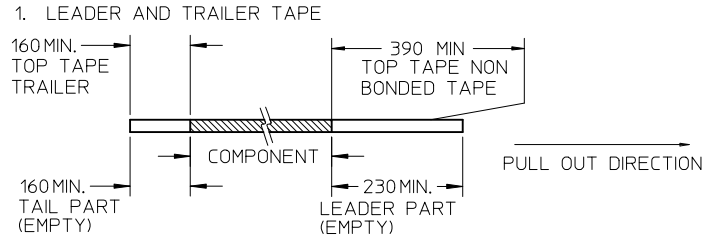

2. PEELING OFF FORCE OF THE TOP TAPE: 20 - 80gf.
(PEELING DIRECTION AS SHOWN IN FOLLOWING FIGURE)

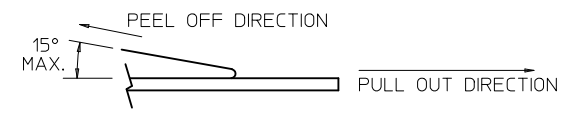

3. TAPE AND REEL SPECIFICATION IS AS PER EIA-481.
4. THE TAPE IS TREATED FOR ANTI-STATIC.

| REV | DESCRIPTION | QUALITY SYMBOLS | GENERAL TOLERANCES (UNLESS SPECIFIED) | | DIMENSION STYLE | SCALE | DESIGN UNITS | THIRD ANGLE PROJECTION | | |
|-----|--|-------------------------------|---------------------------------------|----------------------|-----------------------|---------------------|---------------|--|--|---|
| | | | mm | INCH | MM ONLY | NTS | METRIC | ⊙ | | |
| D7 | PG8. +879140108 EC NO: S2010-0695 DRW:ATSEE 2010/02/11 CHKD:PTLIM 2004/12/08 APPR:MLONG 2010/06/05 | $F_A=0$ $F_C=0$ $F_P=0$ | 4 PLACES ± --- ± --- | 3 PLACES ± --- ± --- | 2 PLACES ± 0.20 ± --- | 1 PLACE ± --- ± --- | ANGULAR ± 3 ° | DRAFT WHERE APPLICABLE MUST REMAIN WITHIN DIMENSIONS | DRAWN BY: KCHO CHECKED BY: PTLIM APPROVED BY: SCLOW DATE: 2004/11/05 DATE: 2004/12/08 DATE: 2004/12/10 MATERIAL NO.: SEE TABLE DOCUMENT NO.: SD-87914-013 | TITLE: 2.54MM PITCH DUAL ROW HEADER SINGLE WAFER, T/H MOLEX INCORPORATED SHEET NO.: 2 OF 46 |

| F | 10 | | 9 | | 8 | | 7 | | 6 | | 5 | | 4 | | 3 | | 2 | | 1 | |
|------------|----------------------------|---|--------------------------------------|--|---|----------|---------------|--------------|-----------|-------|------|------|---|--|---|--|---|--|---|--|
| | PART NO FOR TRAY PACKAGING | PART NO. FOR TUBE WITHOUT CAP PACKAGING | PART NO. FOR TUBE WITH CAP PACKAGING | PART NO. FOR TAPE & REEL WITHOUT CAP PACKAGING | PART NO. FOR TAPE & REEL WITH CAP PACKAGING | CKT SIZE | VOID POSITION | PLATING TYPE | DIMENSION | | | | | | | | | | | |
| | | | | | | | | | A | B | F | M | P | | | | | | | |
| 87914-0211 | ----- | ----- | ----- | ----- | 2 | ---- | 1 | 2.54 | ---- | 10.92 | 5.84 | 2.79 | | | | | | | | |
| 87914-0221 | ----- | ----- | ----- | ----- | 2 | ---- | 1 | 2.54 | ---- | 12.25 | 7.00 | 2.96 | | | | | | | | |
| 87914-0231 | ----- | ----- | ----- | ----- | 2 | ---- | 1 | 2.54 | ---- | 13.38 | 6.09 | 5.00 | | | | | | | | |
| 87914-0212 | ----- | ----- | ----- | ----- | 2 | ---- | 2 | 2.54 | ---- | 10.92 | 5.84 | 2.79 | | | | | | | | |
| 87914-0222 | ----- | ----- | ----- | ----- | 2 | ---- | 2 | 2.54 | ---- | 12.25 | 7.00 | 2.96 | | | | | | | | |
| 87914-0232 | ----- | ----- | ----- | ----- | 2 | ---- | 2 | 2.54 | ---- | 13.38 | 6.09 | 5.00 | | | | | | | | |
| 87914-0213 | ----- | ----- | ----- | ----- | 2 | ---- | 3 | 2.54 | ---- | 10.92 | 5.84 | 2.79 | | | | | | | | |
| 87914-0223 | ----- | ----- | ----- | ----- | 2 | ---- | 3 | 2.54 | ---- | 12.25 | 7.00 | 2.96 | | | | | | | | |
| 87914-0233 | ----- | ----- | ----- | ----- | 2 | ---- | 3 | 2.54 | ---- | 13.38 | 6.09 | 5.00 | | | | | | | | |
| 87914-0214 | ----- | ----- | ----- | ----- | 2 | ---- | 4 | 2.54 | ---- | 10.92 | 5.84 | 2.79 | | | | | | | | |
| 87914-0224 | ----- | ----- | ----- | ----- | 2 | ---- | 4 | 2.54 | ---- | 12.25 | 7.00 | 2.96 | | | | | | | | |
| 87914-0234 | ----- | ----- | ----- | ----- | 2 | ---- | 4 | 2.54 | ---- | 13.38 | 6.09 | 5.00 | | | | | | | | |
| 87914-0215 | ----- | ----- | ----- | ----- | 2 | ---- | 5 | 2.54 | ---- | 10.92 | 5.84 | 2.79 | | | | | | | | |
| 87914-0225 | ----- | ----- | ----- | ----- | 2 | ---- | 5 | 2.54 | ---- | 12.25 | 7.00 | 2.96 | | | | | | | | |
| 87914-0235 | ----- | ----- | ----- | ----- | 2 | ---- | 5 | 2.54 | ---- | 13.38 | 6.09 | 5.00 | | | | | | | | |
| 87914-0216 | ----- | ----- | ----- | ----- | 2 | ---- | 6 | 2.54 | ---- | 10.92 | 5.84 | 2.79 | | | | | | | | |
| 87914-0226 | ----- | ----- | ----- | ----- | 2 | ---- | 6 | 2.54 | ---- | 12.25 | 7.00 | 2.96 | | | | | | | | |
| 87914-0236 | ----- | ----- | ----- | ----- | 2 | ---- | 6 | 2.54 | ---- | 13.38 | 6.09 | 5.00 | | | | | | | | |
| | | | | | | | | | | | | | | | | | | | | |
| | | | | | | | | | | | | | | | | | | | | |
| | | | | | | | | | | | | | | | | | | | | |
| | | | | | | | | | | | | | | | | | | | | |
| | | | | | | | | | | | | | | | | | | | | |
| | | | | | | | | | | | | | | | | | | | | |
| | | | | | | | | | | | | | | | | | | | | |
| | | | | | | | | | | | | | | | | | | | | |
| | | | | | | | | | | | | | | | | | | | | |
| | | | | | | | | | | | | | | | | | | | | |
| | | | | | | | | | | | | | | | | | | | | |
| | | | | | | | | | | | | | | | | | | | | |

| | | | | | | | | | | | | | | | | | | | | | | |
|--|--------------------------|---|--|----------------------------------|----|--------------------------|----------|-----------|-----------|----------|-----------|-----------|----------|------------|-----------|---------|-----------|-----------|--|----------------------------|--------------------------------------|-------------------------------|
| A PG8. +879140108 EC NO: S2010-0695 DRWN:ATSEE 2010/02/11 CHKD:PTLIM 2004/12/08 APPR:MLONG 2010/06/05 | DESCRIPTION D7 | QUALITY SYMBOLS $\nabla_A = 0$ $\nabla_C = 0$ $\nabla_P = 0$ | GENERAL TOLERANCES (UNLESS SPECIFIED) <table border="1"> <tr><td></td><td>mm</td><td>INCH</td></tr> <tr><td>4 PLACES</td><td>\pm ---</td><td>\pm ---</td></tr> <tr><td>3 PLACES</td><td>\pm ---</td><td>\pm ---</td></tr> <tr><td>2 PLACES</td><td>\pm 0.20</td><td>\pm ---</td></tr> <tr><td>1 PLACE</td><td>\pm ---</td><td>\pm ---</td></tr> </table> | | mm | INCH | 4 PLACES | \pm --- | \pm --- | 3 PLACES | \pm --- | \pm --- | 2 PLACES | \pm 0.20 | \pm --- | 1 PLACE | \pm --- | \pm --- | DIMENSION STYLE MM ONLY | SCALE NTS | DESIGN UNITS METRIC | THIRD ANGLE PROJECTION |
| | | | mm | INCH | | | | | | | | | | | | | | | | | | |
| | | 4 PLACES | \pm --- | \pm --- | | | | | | | | | | | | | | | | | | |
| 3 PLACES | \pm --- | \pm --- | | | | | | | | | | | | | | | | | | | | |
| 2 PLACES | \pm 0.20 | \pm --- | | | | | | | | | | | | | | | | | | | | |
| 1 PLACE | \pm --- | \pm --- | | | | | | | | | | | | | | | | | | | | |
| DRAWN BY KCHO DATE 2004/11/05 CHECKED BY PTLIM DATE 2004/12/08 APPROVED BY SCLOW DATE 2004/12/10 | | TITLE 2.54MM PITCH DUAL ROW HEADER SINGLE WAFER, T/H | | MOLEX INCORPORATED | | | | | | | | | | | | | | | | | | |
| DRAFT WHERE APPLICABLE MUST REMAIN WITHIN DIMENSIONS | | SEE TABLE | | DOCUMENT NO. SD-87914-013 | | SHEET NO. 3 OF 46 | | | | | | | | | | | | | | | | |

THIS DRAWING CONTAINS INFORMATION THAT IS PROPRIETARY TO MOLEX INCORPORATED AND SHOULD NOT BE USED WITHOUT WRITTEN PERMISSION

| | 10 | 9 | 8 | 7 | 6 | 5 | 4 | 3 | 2 | 1 | | | |
|---|-----------------------------|---|--------------------------------------|--|---|----------|---------------|--------------|-----------|------|-------|------|------|
| | PART NO. FOR TRAY PACKAGING | PART NO. FOR TUBE WITHOUT CAP PACKAGING | PART NO. FOR TUBE WITH CAP PACKAGING | PART NO. FOR TAPE & REEL WITHOUT CAP PACKAGING | PART NO. FOR TAPE & REEL WITH CAP PACKAGING | CKT SIZE | VOID POSITION | PLATING TYPE | DIMENSION | | | | |
| | | | | | | | | A | B | F | M | P | |
| F | 87914-0411 | ----- | ----- | ----- | ----- | 4 | ---- | 1 | 5.08 | 2.54 | 10.92 | 5.84 | 2.79 |
| | 87914-0421 | ----- | ----- | ----- | ----- | 4 | ---- | 1 | 5.08 | 2.54 | 12.25 | 7.00 | 2.96 |
| | 87914-0431 | ----- | ----- | ----- | ----- | 4 | ---- | 1 | 5.08 | 2.54 | 13.38 | 6.09 | 5.00 |
| | 87914-0412 | ----- | ----- | ----- | ----- | 4 | ---- | 2 | 5.08 | 2.54 | 10.92 | 5.84 | 2.79 |
| | 87914-0422 | ----- | ----- | ----- | ----- | 4 | ---- | 2 | 5.08 | 2.54 | 12.25 | 7.00 | 2.96 |
| | 87914-0432 | ----- | ----- | ----- | ----- | 4 | ---- | 2 | 5.08 | 2.54 | 13.38 | 6.09 | 5.00 |
| E | 87914-0413 | ----- | ----- | ----- | ----- | 4 | ---- | 3 | 5.08 | 2.54 | 10.92 | 5.84 | 2.79 |
| | 87914-0423 | ----- | ----- | ----- | ----- | 4 | ---- | 3 | 5.08 | 2.54 | 12.25 | 7.00 | 2.96 |
| | 87914-0433 | ----- | ----- | ----- | ----- | 4 | ---- | 3 | 5.08 | 2.54 | 13.38 | 6.09 | 5.00 |
| | 87914-0414 | ----- | ----- | ----- | ----- | 4 | ---- | 4 | 5.08 | 2.54 | 10.92 | 5.84 | 2.79 |
| | 87914-0424 | ----- | ----- | ----- | ----- | 4 | ---- | 4 | 5.08 | 2.54 | 12.25 | 7.00 | 2.96 |
| | 87914-0434 | ----- | ----- | ----- | ----- | 4 | ---- | 4 | 5.08 | 2.54 | 13.38 | 6.09 | 5.00 |
| D | 87914-0415 | ----- | ----- | ----- | ----- | 4 | ---- | 5 | 5.08 | 2.54 | 10.92 | 5.84 | 2.79 |
| | 87914-0425 | ----- | ----- | ----- | ----- | 4 | ---- | 5 | 5.08 | 2.54 | 12.25 | 7.00 | 2.96 |
| | 87914-0435 | ----- | ----- | ----- | ----- | 4 | ---- | 5 | 5.08 | 2.54 | 13.38 | 6.09 | 5.00 |
| | 87914-0416 | ----- | ----- | ----- | ----- | 4 | ---- | 6 | 5.08 | 2.54 | 10.92 | 5.84 | 2.79 |
| | 87914-0426 | ----- | ----- | ----- | ----- | 4 | ---- | 6 | 5.08 | 2.54 | 12.25 | 7.00 | 2.96 |
| | 87914-0436 | ----- | ----- | ----- | ----- | 4 | ---- | 6 | 5.08 | 2.54 | 13.38 | 6.09 | 5.00 |
| C | | | | | | | | | | | | | |
| | | | | | | | | | | | | | |
| | | | | | | | | | | | | | |
| | | | | | | | | | | | | | |
| B | | | | | | | | | | | | | |
| | | | | | | | | | | | | | |
| | | | | | | | | | | | | | |

| | | | | | | | | | | | |
|---|---|--|--|-----------------------------------|--|--|-------------------------------------|------------------------|--|-----------------------------|--|
| PG8. +879140108 EC NO: S2010-0695 DRWN:ATSEE 2010/02/11 CHKD:PTLIM 2004/12/08 APPR:MLONG 2010/06/05 D7 | QUALITY SYMBOLS $\nabla_A=0$ $\nabla_C=0$ $\nabla_P=0$ | GENERAL TOLERANCES (UNLESS SPECIFIED) | | DIMENSION STYLE MM ONLY | | SCALE NTS | DESIGN UNITS METRIC | THIRD ANGLE PROJECTION | | | |
| | | | | DRAWN BY KCHO | DATE 2004/11/05 | TITLE 2.54MM PITCH DUAL ROW HEADER SINGLE WAFER, T/H | | | | | |
| | | | | CHECKED BY PTLIM | DATE 2004/12/08 | APPROVED BY SCLOW | | | | | |
| | | | | MATERIAL NO. SEE TABLE | | DATE 2004/12/10 | DOCUMENT NO. SD-87914-013 | | | SHEET NO. 4 OF 46 | |
| | | DRAFT WHERE APPLICABLE MUST REMAIN WITHIN DIMENSIONS | | | THIS DRAWING CONTAINS INFORMATION THAT IS PROPRIETARY TO MOLEX INCORPORATED AND SHOULD NOT BE USED WITHOUT WRITTEN PERMISSION | | | | | | |

| PART NO FOR TRAY PACKAGING | PART NO. FOR TUBE WITHOUT CAP PACKAGING | PART NO. FOR TUBE WITH CAP PACKAGING | PART NO. FOR TAPE & REEL WITHOUT CAP PACKAGING | PART NO. FOR TAPE & REEL WITH CAP PACKAGING | CKT SIZE | VOID POSITION | PLATING TYPE | DIMENSION | | | | | |
|----------------------------|---|--------------------------------------|--|---|----------|---------------|--------------|-----------|------|-------|------|------|-------|
| | | | | | | | | A | B | F | M | P | G |
| 87914-0611 | ----- | ----- | ----- | ----- | 6 | ---- | 1 | 7.62 | 5.08 | 10.92 | 5.84 | 2.79 | ---- |
| 87914-0621 | ----- | ----- | ----- | ----- | 6 | ---- | 1 | 7.62 | 5.08 | 12.25 | 7.00 | 2.96 | ---- |
| 87914-0631 | ----- | ----- | ----- | ----- | 6 | ---- | 1 | 7.62 | 5.08 | 13.38 | 6.09 | 5.00 | ---- |
| 87914-0612 | ----- | ----- | ----- | ----- | 6 | ---- | 2 | 7.62 | 5.08 | 10.92 | 5.84 | 2.79 | ---- |
| 87914-0622 | ----- | ----- | ----- | ----- | 6 | ---- | 2 | 7.62 | 5.08 | 12.25 | 7.00 | 2.96 | ---- |
| 87914-0632 | ----- | ----- | ----- | ----- | 6 | ---- | 2 | 7.62 | 5.08 | 13.38 | 6.09 | 5.00 | ---- |
| 87914-0613 | ----- | ----- | ----- | ----- | 6 | ---- | 3 | 7.62 | 5.08 | 10.92 | 5.84 | 2.79 | ---- |
| 87914-0623 | ----- | ----- | ----- | ----- | 6 | ---- | 3 | 7.62 | 5.08 | 12.25 | 7.00 | 2.96 | ---- |
| 87914-0633 | ----- | ----- | ----- | ----- | 6 | ---- | 3 | 7.62 | 5.08 | 13.38 | 6.09 | 5.00 | ---- |
| 87914-0614 | ----- | ----- | ----- | ----- | 6 | ---- | 4 | 7.62 | 5.08 | 10.92 | 5.84 | 2.79 | ---- |
| 87914-0624 | ----- | ----- | ----- | ----- | 6 | ---- | 4 | 7.62 | 5.08 | 12.25 | 7.00 | 2.96 | ---- |
| 87914-0634 | ----- | ----- | ----- | ----- | 6 | ---- | 4 | 7.62 | 5.08 | 13.38 | 6.09 | 5.00 | ---- |
| 87914-0615 | ----- | ----- | ----- | ----- | 6 | ---- | 5 | 7.62 | 5.08 | 10.92 | 5.84 | 2.79 | ---- |
| 87914-0625 | ----- | ----- | ----- | ----- | 6 | ---- | 5 | 7.62 | 5.08 | 12.25 | 7.00 | 2.96 | ---- |
| 87914-0635 | ----- | ----- | ----- | ----- | 6 | ---- | 5 | 7.62 | 5.08 | 13.38 | 6.09 | 5.00 | ---- |
| 87914-0616 | ----- | ----- | ----- | ----- | 6 | ---- | 6 | 7.62 | 5.08 | 10.92 | 5.84 | 2.79 | ---- |
| 87914-0626 | ----- | ----- | ----- | ----- | 6 | ---- | 6 | 7.62 | 5.08 | 12.25 | 7.00 | 2.96 | ---- |
| 87914-0636 | ----- | ----- | ----- | ----- | 6 | ---- | 6 | 7.62 | 5.08 | 13.38 | 6.09 | 5.00 | ---- |
| ----- | ----- | ----- | ----- | 87914-0627 | 6 | ---- | 6 | 7.62 | 5.08 | 13.55 | 8.08 | 3.18 | 14.70 |

| | | | | | | | | | | | | | | | | | | | | | |
|--|--|--|--|--|--|--|--|--|--|--|--|--|--------------|------------------------|------------------------|--|--|--|----------------------------------|-------------------------------------|-----------------------------|
| <p>PG8. +879140108 EC NO: S2010-0695 DRWN:ATSEE 2010/02/11 CHKD:PTLIM 2004/12/08 APPR:MLONG 2010/06/05</p> | | | | | | | | | | QUALITY SYMBOLS $F_A=0$ $F_G=0$ $F_P=0$ | GENERAL TOLERANCES (UNLESS SPECIFIED) mm INCH 4 PLACES ± --- ± --- 3 PLACES ± --- ± --- 2 PLACES ± 0.20 ± --- 1 PLACE ± --- ± --- ANGULAR ± 3 ° | DIMENSION STYLE MM ONLY DRAWN BY: KCHO DATE: 2004/11/05 CHECKED BY: PTLIM DATE: 2004/12/08 APPROVED BY: SCLOW DATE: 2004/12/10 | SCALE NTS | DESIGN UNITS METRIC | THIRD ANGLE PROJECTION | TITLE 2.54MM PITCH DUAL ROW HEADER SINGLE WAFER, T/H | | | MATERIAL NO. SEE TABLE | DOCUMENT NO. SD-87914-013 | SHEET NO. 5 OF 46 |
|--|--|--|--|--|--|--|--|--|--|--|--|--|--------------|------------------------|------------------------|--|--|--|----------------------------------|-------------------------------------|-----------------------------|

| | | | | | | | | | | | | | |
|--|--|--|--|--|--|--|--|--|--|-------------------|---|--|--|
| DRAFT WHERE APPLICABLE MUST REMAIN WITHIN DIMENSIONS | | | | | | | | | | SIZE A3 | THIS DRAWING CONTAINS INFORMATION THAT IS PROPRIETARY TO MOLEX INCORPORATED AND SHOULD NOT BE USED WITHOUT WRITTEN PERMISSION | | |
|--|--|--|--|--|--|--|--|--|--|-------------------|---|--|--|

| | 10 | 9 | 8 | 7 | 6 | 5 | 4 | 3 | 2 | 1 | | | |
|---|----------------------------|---|--------------------------------------|--|---|----------|---------------|--------------|-----------|------|-------|-------|------|
| | PART NO FOR TRAY PACKAGING | PART NO. FOR TUBE WITHOUT CAP PACKAGING | PART NO. FOR TUBE WITH CAP PACKAGING | PART NO. FOR TAPE & REEL WITHOUT CAP PACKAGING | PART NO. FOR TAPE & REEL WITH CAP PACKAGING | CKT SIZE | VOID POSITION | PLATING TYPE | DIMENSION | | | | |
| | | | | | | | | A | B | F | M | P | |
| F | 87914-0009 | ----- | ----- | ----- | ----- | 6 | ----- | 1 | 7.62 | 5.08 | 18.84 | 13.25 | 3.30 |
| | 87914-0642 | ----- | ----- | ----- | ----- | 6 | ----- | 2 | 7.62 | 5.08 | 18.84 | 13.25 | 3.30 |
| | 87914-0643 | ----- | ----- | ----- | ----- | 6 | ----- | 3 | 7.62 | 5.08 | 18.84 | 13.25 | 3.30 |
| | 87914-0644 | ----- | ----- | ----- | ----- | 6 | ----- | 4 | 7.62 | 5.08 | 18.84 | 13.25 | 3.30 |
| | 87914-0645 | ----- | ----- | ----- | ----- | 6 | ----- | 5 | 7.62 | 5.08 | 18.84 | 13.25 | 3.30 |
| | 87914-0646 | ----- | ----- | ----- | ----- | 6 | ----- | 6 | 7.62 | 5.08 | 18.84 | 13.25 | 3.30 |
| E | | | | | | | | | | | | | |
| | | | | | | | | | | | | | |
| | | | | | | | | | | | | | |
| | | | | | | | | | | | | | |
| D | | | | | | | | | | | | | |
| | | | | | | | | | | | | | |
| | | | | | | | | | | | | | |
| | | | | | | | | | | | | | |
| | | | | | | | | | | | | | |
| C | | | | | | | | | | | | | |

| PG8. +879140108 EC NO: S2010-0695 DRWN:ATSEE 2010/02/11 CHKD:PTLIM 2004/12/08 APPR:MLONG 2010/06/05 | QUALITY SYMBOLS | GENERAL TOLERANCES (UNLESS SPECIFIED) | DIMENSION STYLE | SCALE | DESIGN UNITS | THIRD ANGLE PROJECTION | | | | | | | | | | | | | | | | | |
|--|---|--|-----------------|-------|--------------|------------------------|--|------------|----------|-------|------------|-------------|--------|--------------------|---------|------------|--|--------------|--------------|-----------|-----------|--------------|---------|
| | $\nabla_A = 0$ $\nabla_C = 0$ $\nabla_P = 0$ | <table border="1"> <tr> <th></th> <th>mm</th> <th>INCH</th> </tr> <tr> <td>4 PLACES</td> <td>± ---</td> <td>± ---</td> </tr> <tr> <td>3 PLACES</td> <td>± ---</td> <td>± ---</td> </tr> <tr> <td>2 PLACES</td> <td>± 0.20</td> <td>± ---</td> </tr> <tr> <td>1 PLACE</td> <td>± ---</td> <td>± ---</td> </tr> </table> | | mm | INCH | 4 PLACES | ± --- | ± --- | 3 PLACES | ± --- | ± --- | 2 PLACES | ± 0.20 | ± --- | 1 PLACE | ± --- | ± --- | MM ONLY | NTS | METRIC | | | |
| | | mm | INCH | | | | | | | | | | | | | | | | | | | | |
| | 4 PLACES | ± --- | ± --- | | | | | | | | | | | | | | | | | | | | |
| 3 PLACES | ± --- | ± --- | | | | | | | | | | | | | | | | | | | | | |
| 2 PLACES | ± 0.20 | ± --- | | | | | | | | | | | | | | | | | | | | | |
| 1 PLACE | ± --- | ± --- | | | | | | | | | | | | | | | | | | | | | |
| DESCRIPTION | <table border="1"> <tr> <th>DRAWN BY</th> <th>DATE</th> <th>TITLE</th> </tr> <tr> <td>KCHO</td> <td>2004/11/05</td> <td rowspan="3">2.54MM PITCH DUAL ROW HEADER SINGLE WAFER, T/H</td> </tr> <tr> <th>CHECKED BY</th> <th>DATE</th> </tr> <tr> <td>PTLIM</td> <td>2004/12/08</td> </tr> <tr> <th>APPROVED BY</th> <th>DATE</th> <td rowspan="2">MOLEX INCORPORATED</td> </tr> <tr> <td>SCLOW</td> <td>2004/12/10</td> </tr> </table> | DRAWN BY | DATE | TITLE | KCHO | 2004/11/05 | 2.54MM PITCH DUAL ROW HEADER SINGLE WAFER, T/H | CHECKED BY | DATE | PTLIM | 2004/12/08 | APPROVED BY | DATE | MOLEX INCORPORATED | SCLOW | 2004/12/10 | <table border="1"> <tr> <th>MATERIAL NO.</th> <th>DOCUMENT NO.</th> <th>SHEET NO.</th> </tr> <tr> <td>SEE TABLE</td> <td>SD-87914-013</td> <td>6 OF 46</td> </tr> </table> | MATERIAL NO. | DOCUMENT NO. | SHEET NO. | SEE TABLE | SD-87914-013 | 6 OF 46 |
| DRAWN BY | DATE | TITLE | | | | | | | | | | | | | | | | | | | | | |
| KCHO | 2004/11/05 | 2.54MM PITCH DUAL ROW HEADER SINGLE WAFER, T/H | | | | | | | | | | | | | | | | | | | | | |
| CHECKED BY | DATE | | | | | | | | | | | | | | | | | | | | | | |
| PTLIM | 2004/12/08 | | | | | | | | | | | | | | | | | | | | | | |
| APPROVED BY | DATE | MOLEX INCORPORATED | | | | | | | | | | | | | | | | | | | | | |
| SCLOW | 2004/12/10 | | | | | | | | | | | | | | | | | | | | | | |
| MATERIAL NO. | DOCUMENT NO. | SHEET NO. | | | | | | | | | | | | | | | | | | | | | |
| SEE TABLE | SD-87914-013 | 6 OF 46 | | | | | | | | | | | | | | | | | | | | | |
| D7 | DRAFT WHERE APPLICABLE MUST REMAIN WITHIN DIMENSIONS | THIS DRAWING CONTAINS INFORMATION THAT IS PROPRIETARY TO MOLEX INCORPORATED AND SHOULD NOT BE USED WITHOUT WRITTEN PERMISSION | | | | | | | | | | | | | | | | | | | | | |

| | 10 | 9 | 8 | 7 | 6 | 5 | 4 | 3 | 2 | 1 | | | | |
|---|-----------------------------|---|--------------------------------------|--|---|----------|---------------|--------------|-----------|------|-------|-------|------|-------|
| | PART NO. FOR TRAY PACKAGING | PART NO. FOR TUBE WITHOUT CAP PACKAGING | PART NO. FOR TUBE WITH CAP PACKAGING | PART NO. FOR TAPE & REEL WITHOUT CAP PACKAGING | PART NO. FOR TAPE & REEL WITH CAP PACKAGING | CKT SIZE | VOID POSITION | PLATING TYPE | DIMENSION | | | | | |
| | | | | | | | | | A | B | F | M | P | G |
| F | 87914-0811 | ----- | ----- | ----- | ----- | 8 | ----- | 1 | 10.16 | 7.62 | 10.92 | 5.84 | 2.79 | ---- |
| | 87914-0821 | ----- | ----- | ----- | ----- | 8 | ----- | 1 | 10.16 | 7.62 | 12.25 | 7.00 | 2.96 | ---- |
| | 87914-0831 | ----- | ----- | ----- | ----- | 8 | ----- | 1 | 10.16 | 7.62 | 13.38 | 6.09 | 5.00 | ---- |
| | 87914-0812 | ----- | ----- | ----- | ----- | 8 | ----- | 2 | 10.16 | 7.62 | 10.92 | 5.84 | 2.79 | ---- |
| | 87914-0822 | ----- | ----- | ----- | ----- | 8 | ----- | 2 | 10.16 | 7.62 | 12.25 | 7.00 | 2.96 | ---- |
| | 87914-0832 | ----- | ----- | ----- | ----- | 8 | ----- | 2 | 10.16 | 7.62 | 13.38 | 6.09 | 5.00 | ---- |
| E | 87914-0813 | ----- | ----- | ----- | ----- | 8 | ----- | 3 | 10.16 | 7.62 | 10.92 | 5.84 | 2.79 | ---- |
| | 87914-0823 | ----- | ----- | ----- | ----- | 8 | ----- | 3 | 10.16 | 7.62 | 12.25 | 7.00 | 2.96 | ---- |
| | 87914-0833 | ----- | ----- | ----- | ----- | 8 | ----- | 4 | 10.16 | 7.62 | 13.38 | 6.09 | 5.00 | ---- |
| | 87914-0814 | ----- | ----- | ----- | ----- | 8 | ----- | 4 | 10.16 | 7.62 | 10.92 | 5.84 | 2.79 | ---- |
| | 87914-0824 | ----- | ----- | ----- | ----- | 8 | ----- | 4 | 10.16 | 7.62 | 12.25 | 7.00 | 2.96 | ---- |
| | 87914-0834 | ----- | ----- | ----- | ----- | 8 | ----- | 4 | 10.16 | 7.62 | 13.38 | 6.09 | 5.00 | ---- |
| D | 87914-0815 | ----- | ----- | ----- | ----- | 8 | ----- | 5 | 10.16 | 7.62 | 10.92 | 5.84 | 2.79 | ---- |
| | 87914-0825 | ----- | ----- | ----- | ----- | 8 | ----- | 5 | 10.16 | 7.62 | 12.25 | 7.00 | 2.96 | ---- |
| | 87914-0835 | ----- | ----- | ----- | ----- | 8 | ----- | 5 | 10.16 | 7.62 | 13.38 | 6.09 | 5.00 | ---- |
| | 87914-0816 | ----- | ----- | ----- | ----- | 8 | ----- | 6 | 10.16 | 7.62 | 10.92 | 5.84 | 2.79 | ---- |
| | 87914-0826 | ----- | ----- | ----- | ----- | 8 | ----- | 6 | 10.16 | 7.62 | 12.25 | 7.00 | 2.96 | ---- |
| | 87914-0836 | ----- | ----- | ----- | ----- | 8 | ----- | 6 | 10.16 | 7.62 | 13.38 | 6.09 | 5.00 | ---- |
| C | 87914-0807 | ----- | ----- | ----- | ----- | 8 | 2,3,4,5,6,8 | 6 | 10.16 | 7.62 | 21.75 | 16.51 | 2.95 | ---- |
| | ----- | ----- | ----- | ----- | 87914-0827 | 8 | ----- | 6 | 10.16 | 7.62 | 13.55 | 8.08 | 3.18 | 14.70 |

B

| | | | | | | | | | | |
|---|-----------------|--|--|-----------------------------------|---|--|------------------------|----------------------|--|--|
| PG8. +879140108 EC NO: S2010-0695 DRW:ATSEE 2010/02/11 CHKD:PTLIM 2004/12/08 APPR:MLONG 2010/06/05 | QUALITY SYMBOLS | $\nabla_A = 0$ $\nabla_C = 0$ $\nabla_P = 0$ | GENERAL TOLERANCES (UNLESS SPECIFIED) | DIMENSION STYLE MM ONLY | SCALE NTS | DESIGN UNITS METRIC | THIRD ANGLE PROJECTION | | | |
| | DESCRIPTION | | | DRAWN BY KCHO | DATE 2004/11/05 | 2.54MM PITCH DUAL ROW HEADER SINGLE WAFER, T/H MOLEX INCORPORATED | | | | |
| | REV | | | CHECKED BY PTLIM | DATE 2004/12/08 | | | | | |
| | D7 | | | APPROVED BY SCLOW | DATE 2004/12/10 | | | | | |
| | | | MATERIAL NO. | DOCUMENT NO. | | | | | | |
| | | | DRAFT WHERE APPLICABLE MUST REMAIN WITHIN DIMENSIONS | SEE TABLE | SD-87914-013 | | | SHEET NO. 7 OF 46 | | |
| | | | | SIZE A3 | THIS DRAWING CONTAINS INFORMATION THAT IS PROPRIETARY TO MOLEX INCORPORATED AND SHOULD NOT BE USED WITHOUT WRITTEN PERMISSION | | | | | |

| PART NO FOR TRAY PACKAGING | PART NO. FOR TUBE WITHOUT CAP PACKAGING | PART NO. FOR TUBE WITH CAP PACKAGING | PART NO. FOR TAPE & REEL WITHOUT CAP PACKAGING | PART NO. FOR TAPE & REEL WITH CAP PACKAGING | PART NO. FOR BULK PACKAGING | CKT SIZE | VOID POSITION | PLATING TYPE | DIMENSION | | | | | |
|----------------------------|---|--------------------------------------|--|---|-----------------------------|----------|---------------|--------------|-----------|------------|-------|-------|-------|-------|
| | | | | | | | | | A | B | F | M | P | G |
| | | | | | | | | | F | 87914-1011 | ----- | ----- | ----- | ----- |
| | 87914-1021 | ----- | ----- | ----- | ----- | 10 | ---- | 1 | 12.70 | 10.16 | 12.25 | 7.00 | 2.96 | ---- |
| | 87914-1031 | ----- | ----- | ----- | ----- | 10 | ---- | 1 | 12.70 | 10.16 | 13.38 | 6.09 | 5.00 | ---- |
| | 87914-1012 | ----- | ----- | ----- | ----- | 10 | ---- | 2 | 12.70 | 10.16 | 10.92 | 5.84 | 2.79 | ---- |
| | 87914-1022 | ----- | ----- | ----- | ----- | 10 | ---- | 2 | 12.70 | 10.16 | 12.25 | 7.00 | 2.96 | ---- |
| | 87914-1032 | ----- | ----- | ----- | ----- | 10 | ---- | 2 | 12.70 | 10.16 | 13.38 | 6.09 | 5.00 | ---- |
| E | 87914-1013 | ----- | ----- | ----- | ----- | 10 | ---- | 3 | 12.70 | 10.16 | 10.92 | 5.84 | 2.79 | ---- |
| | 87914-1023 | ----- | ----- | ----- | ----- | 10 | ---- | 3 | 12.70 | 10.16 | 12.25 | 7.00 | 2.96 | ---- |
| | 87914-1033 | ----- | ----- | ----- | ----- | 10 | ---- | 3 | 12.70 | 10.16 | 13.38 | 6.09 | 5.00 | ---- |
| | 87914-1014 | ----- | ----- | ----- | ----- | 10 | ---- | 4 | 12.70 | 10.16 | 10.92 | 5.84 | 2.79 | ---- |
| | 87914-1024 | ----- | ----- | ----- | ----- | 10 | ---- | 4 | 12.70 | 10.16 | 12.25 | 7.00 | 2.96 | ---- |
| | 87914-1034 | ----- | ----- | ----- | ----- | 10 | ---- | 4 | 12.70 | 10.16 | 13.38 | 6.09 | 5.00 | ---- |
| D | 87914-1015 | ----- | ----- | ----- | ----- | 10 | ---- | 5 | 12.70 | 10.16 | 10.92 | 5.84 | 2.79 | ---- |
| | 87914-1025 | ----- | ----- | ----- | ----- | 10 | ---- | 5 | 12.70 | 10.16 | 12.25 | 7.00 | 2.96 | ---- |
| | 87914-1035 | ----- | ----- | ----- | ----- | 10 | ---- | 5 | 12.70 | 10.16 | 13.38 | 6.09 | 5.00 | ---- |
| | 87914-1016 | ----- | ----- | ----- | ----- | 10 | ---- | 6 | 12.70 | 10.16 | 10.92 | 5.84 | 2.79 | ---- |
| | 87914-1026 | ----- | ----- | ----- | ----- | 10 | ---- | 6 | 12.70 | 10.16 | 12.25 | 7.00 | 2.96 | ---- |
| | 87914-1036 | ----- | ----- | ----- | ----- | 10 | ---- | 6 | 12.70 | 10.16 | 13.38 | 6.09 | 5.00 | ---- |
| C | 87914-0001 | ----- | ----- | ----- | ----- | 10 | ---- | 7 | 12.70 | 10.16 | 12.07 | 5.97 | 3.81 | ---- |
| | ----- | ----- | ----- | ----- | 87914-1037 | 10 | 9 | 4 | 12.70 | 10.16 | 10.92 | 5.84 | 2.79 | ---- |
| | | | | | | | | | | | | | | |
| | | | | | | | | | | | | | | |
| | | | | | | | | | | | | | | |
| | | | | | | | | | | | | | | |
| B | | | | | | | | | | | | | | |

| PG8, +879140108 EC NO: S2010-0695 DRWN:ATSEE 2010/02/11 CHKD:PTLIM 2004/12/08 APPR:MLONG 2010/06/05 | QUALITY SYMBOLS $F_A=0$ $F_G=0$ $F_P=0$ | GENERAL TOLERANCES (UNLESS SPECIFIED) <table border="1"> <tr><th colspan="2">mm</th><th>INCH</th></tr> <tr><td>4 PLACES</td><td>± ---</td><td>± ---</td></tr> <tr><td>3 PLACES</td><td>± ---</td><td>± ---</td></tr> <tr><td>2 PLACES</td><td>± 0.20</td><td>± ---</td></tr> <tr><td>1 PLACE</td><td>± ---</td><td>± ---</td></tr> </table> | mm | | INCH | 4 PLACES | ± --- | ± --- | 3 PLACES | ± --- | ± --- | 2 PLACES | ± 0.20 | ± --- | 1 PLACE | ± --- | ± --- | DIMENSION STYLE MM ONLY DRAWN BY: KCHO DATE: 2004/11/05 CHECKED BY: PTLIM DATE: 2004/12/08 APPROVED BY: SCLOW DATE: 2004/12/10 | SCALE: NTS DESIGN UNITS: METRIC THIRD ANGLE PROJECTION | TITLE: 2.54MM PITCH DUAL ROW HEADER SINGLE WAFER, T/H MOLEX INCORPORATED |
|--|---|--|-------|--|------|----------|-------|-------|----------|-------|-------|----------|--------|-------|---------|-------|-------|---|--|--|
| | mm | | INCH | | | | | | | | | | | | | | | | | |
| | 4 PLACES | ± --- | ± --- | | | | | | | | | | | | | | | | | |
| | 3 PLACES | ± --- | ± --- | | | | | | | | | | | | | | | | | |
| 2 PLACES | ± 0.20 | ± --- | | | | | | | | | | | | | | | | | | |
| 1 PLACE | ± --- | ± --- | | | | | | | | | | | | | | | | | | |
| DRAFT WHERE APPLICABLE MUST REMAIN WITHIN DIMENSIONS | MATERIAL NO.: SEE TABLE DOCUMENT NO.: SD-87914-013 SHEET NO.: 9 OF 46 | | | | | | | | | | | | | | | | | | | |
| SIZE: A3 THIS DRAWING CONTAINS INFORMATION THAT IS PROPRIETARY TO MOLEX INCORPORATED AND SHOULD NOT BE USED WITHOUT WRITTEN PERMISSION | | | | | | | | | | | | | | | | | | | | |
| | | | | | | | | | | | | | | | | | | | | |

| | 10 | 9 | 8 | 7 | 6 | 5 | 4 | 3 | 2 | 1 | | | |
|---|----------------------------|---|--------------------------------------|--|---|----------|---------------|--------------|-----------|-------|-------|------|------|
| | PART NO FOR TRAY PACKAGING | PART NO. FOR TUBE WITHOUT CAP PACKAGING | PART NO. FOR TUBE WITH CAP PACKAGING | PART NO. FOR TAPE & REEL WITHOUT CAP PACKAGING | PART NO. FOR TAPE & REEL WITH CAP PACKAGING | CKT SIZE | VOID POSITION | PLATING TYPE | DIMENSION | | | | |
| | | | | | | | | A | B | F | M | P | |
| F | 87914-1211 | ----- | ----- | ----- | ----- | 12 | ---- | 1 | 15.24 | 12.70 | 10.92 | 5.84 | 2.79 |
| | 87914-1221 | ----- | ----- | ----- | ----- | 12 | ---- | 1 | 15.24 | 12.70 | 12.25 | 7.00 | 2.96 |
| | 87914-1231 | ----- | ----- | ----- | ----- | 12 | ---- | 1 | 15.24 | 12.70 | 13.38 | 6.09 | 5.00 |
| | 87914-1212 | ----- | ----- | ----- | ----- | 12 | ---- | 2 | 15.24 | 12.70 | 10.92 | 5.84 | 2.79 |
| | 87914-1222 | ----- | ----- | ----- | ----- | 12 | ---- | 2 | 15.24 | 12.70 | 12.25 | 7.00 | 2.96 |
| | 87914-1232 | ----- | ----- | ----- | ----- | 12 | ---- | 2 | 15.24 | 12.70 | 13.38 | 6.09 | 5.00 |
| E | 87914-1213 | ----- | ----- | ----- | ----- | 12 | ---- | 3 | 15.24 | 12.70 | 10.92 | 5.84 | 2.79 |
| | 87914-1223 | ----- | ----- | ----- | ----- | 12 | ---- | 3 | 15.24 | 12.70 | 12.25 | 7.00 | 2.96 |
| | 87914-1233 | ----- | ----- | ----- | ----- | 12 | ---- | 3 | 15.24 | 12.70 | 13.38 | 6.09 | 5.00 |
| | 87914-1214 | ----- | ----- | ----- | ----- | 12 | ---- | 4 | 15.24 | 12.70 | 10.92 | 5.84 | 2.79 |
| | 87914-1224 | ----- | ----- | ----- | ----- | 12 | ---- | 4 | 15.24 | 12.70 | 12.25 | 7.00 | 2.96 |
| | 87914-1234 | ----- | ----- | ----- | ----- | 12 | ---- | 4 | 15.24 | 12.70 | 13.38 | 6.09 | 5.00 |
| D | 87914-1215 | ----- | ----- | ----- | ----- | 12 | ---- | 5 | 15.24 | 12.70 | 10.92 | 5.84 | 2.79 |
| | 87914-1225 | ----- | ----- | ----- | ----- | 12 | ---- | 5 | 15.24 | 12.70 | 12.25 | 7.00 | 2.96 |
| | 87914-1235 | ----- | ----- | ----- | ----- | 12 | ---- | 5 | 15.24 | 12.70 | 13.38 | 6.09 | 5.00 |
| | 87914-1216 | ----- | ----- | ----- | ----- | 12 | ---- | 6 | 15.24 | 12.70 | 10.92 | 5.84 | 2.79 |
| | 87914-1226 | ----- | ----- | ----- | ----- | 12 | ---- | 6 | 15.24 | 12.70 | 12.25 | 7.00 | 2.96 |
| | 87914-1236 | ----- | ----- | ----- | ----- | 12 | ---- | 6 | 15.24 | 12.70 | 13.38 | 6.09 | 5.00 |

C

B

| PG8. +879140108 EC NO: S2010-0695 DRWN:ATSEE 2010/02/11 CHKD:PTLIM 2004/12/08 APPR:MLONG 2010/06/05 | QUALITY SYMBOLS | GENERAL TOLERANCES (UNLESS SPECIFIED) | DIMENSION STYLE | SCALE | DESIGN UNITS | THIRD ANGLE PROJECTION | | | | | | | | | | | | | | | | | | | |
|--|---|--|-----------------|-------|--------------|---|----------|-------|----------|-------|------------|--|------------|-------|---------|------------|-------------|---------|--------------------|--------|------------|--|-----------|--------------|----------|
| | $\nabla_A = 0$ $\nabla_C = 0$ $\nabla_P = 0$ | <table border="1"> <tr> <th></th> <th>mm</th> <th>INCH</th> </tr> <tr> <td>4 PLACES</td> <td>± ---</td> <td>± ---</td> </tr> <tr> <td>3 PLACES</td> <td>± ---</td> <td>± ---</td> </tr> <tr> <td>2 PLACES</td> <td>± 0.20</td> <td>± ---</td> </tr> <tr> <td>1 PLACE</td> <td>± ---</td> <td>± ---</td> </tr> </table> | | mm | INCH | 4 PLACES | ± --- | ± --- | 3 PLACES | ± --- | ± --- | 2 PLACES | ± 0.20 | ± --- | 1 PLACE | ± --- | ± --- | MM ONLY | NTS | METRIC | | | | | |
| | | mm | INCH | | | | | | | | | | | | | | | | | | | | | | |
| | 4 PLACES | ± --- | ± --- | | | | | | | | | | | | | | | | | | | | | | |
| 3 PLACES | ± --- | ± --- | | | | | | | | | | | | | | | | | | | | | | | |
| 2 PLACES | ± 0.20 | ± --- | | | | | | | | | | | | | | | | | | | | | | | |
| 1 PLACE | ± --- | ± --- | | | | | | | | | | | | | | | | | | | | | | | |
| DESCRIPTION | <table border="1"> <tr> <th>REV</th> <th>DESCRIPTION</th> </tr> <tr> <td>D7</td> <td></td> </tr> </table> | REV | DESCRIPTION | D7 | | <table border="1"> <tr> <th>DRAWN BY</th> <th>DATE</th> <th>TITLE</th> </tr> <tr> <td>KCHO</td> <td>2004/11/05</td> <td rowspan="3">2.54MM PITCH DUAL ROW HEADER SINGLE WAFER, T/H</td> </tr> <tr> <th>CHECKED BY</th> <th>DATE</th> </tr> <tr> <td>PTLIM</td> <td>2004/12/08</td> </tr> <tr> <th>APPROVED BY</th> <th>DATE</th> <td>MOLEX INCORPORATED</td> </tr> <tr> <td>SCLOW</td> <td>2004/12/10</td> <td></td> </tr> </table> | DRAWN BY | DATE | TITLE | KCHO | 2004/11/05 | 2.54MM PITCH DUAL ROW HEADER SINGLE WAFER, T/H | CHECKED BY | DATE | PTLIM | 2004/12/08 | APPROVED BY | DATE | MOLEX INCORPORATED | SCLOW | 2004/12/10 | | SEE TABLE | SD-87914-013 | 10 OF 46 |
| REV | DESCRIPTION | | | | | | | | | | | | | | | | | | | | | | | | |
| D7 | | | | | | | | | | | | | | | | | | | | | | | | | |
| DRAWN BY | DATE | TITLE | | | | | | | | | | | | | | | | | | | | | | | |
| KCHO | 2004/11/05 | 2.54MM PITCH DUAL ROW HEADER SINGLE WAFER, T/H | | | | | | | | | | | | | | | | | | | | | | | |
| CHECKED BY | DATE | | | | | | | | | | | | | | | | | | | | | | | | |
| PTLIM | 2004/12/08 | | | | | | | | | | | | | | | | | | | | | | | | |
| APPROVED BY | DATE | MOLEX INCORPORATED | | | | | | | | | | | | | | | | | | | | | | | |
| SCLOW | 2004/12/10 | | | | | | | | | | | | | | | | | | | | | | | | |
| | DRAFT WHERE APPLICABLE MUST REMAIN WITHIN DIMENSIONS | THIS DRAWING CONTAINS INFORMATION THAT IS PROPRIETARY TO MOLEX INCORPORATED AND SHOULD NOT BE USED WITHOUT WRITTEN PERMISSION | | | | | | | | | | | | | | | | | | | | | | | |

| PART NO FOR TRAY PACKAGING | PART NO. FOR TUBE WITHOUT CAP PACKAGING | PART NO. FOR TUBE WITH CAP PACKAGING | PART NO. FOR TAPE & REEL WITHOUT CAP PACKAGING | PART NO. FOR TAPE & REEL WITH CAP PACKAGING | CKT SIZE | VOID POSITION | PLATING TYPE | DIMENSION | | | | |
|----------------------------|---|--------------------------------------|--|---|----------|---------------|--------------|-----------|------------|-------|-------|-------|
| | | | | | | | | A | B | F | M | P |
| | | | | | | | | F | 87914-1411 | ----- | ----- | ----- |
| | 87914-1421 | ----- | ----- | ----- | 14 | ---- | 1 | 17.78 | 15.24 | 12.25 | 7.00 | 2.96 |
| | 87914-1431 | ----- | ----- | ----- | 14 | ---- | 1 | 17.78 | 15.24 | 13.38 | 6.09 | 5.00 |
| | 87914-1412 | ----- | ----- | ----- | 14 | ---- | 2 | 17.78 | 15.24 | 10.92 | 5.84 | 2.79 |
| | 87914-1422 | ----- | ----- | ----- | 14 | ---- | 2 | 17.78 | 15.24 | 12.25 | 7.00 | 2.96 |
| | 87914-1432 | ----- | ----- | ----- | 14 | ---- | 2 | 17.78 | 15.24 | 13.38 | 6.09 | 5.00 |
| E | 87914-1413 | ----- | ----- | ----- | 14 | ---- | 3 | 17.78 | 15.24 | 10.92 | 5.84 | 2.79 |
| | 87914-1423 | ----- | ----- | ----- | 14 | ---- | 3 | 17.78 | 15.24 | 12.25 | 7.00 | 2.96 |
| | 87914-1433 | ----- | ----- | ----- | 14 | ---- | 3 | 17.78 | 15.24 | 13.38 | 6.09 | 5.00 |
| | 87914-1414 | ----- | ----- | ----- | 14 | ---- | 4 | 17.78 | 15.24 | 10.92 | 5.84 | 2.79 |
| | 87914-1424 | ----- | ----- | ----- | 14 | ---- | 4 | 17.78 | 15.24 | 12.25 | 7.00 | 2.96 |
| | 87914-1434 | ----- | ----- | ----- | 14 | ---- | 4 | 17.78 | 15.24 | 13.38 | 6.09 | 5.00 |
| D | 87914-1415 | ----- | ----- | ----- | 14 | ---- | 5 | 17.78 | 15.24 | 10.92 | 5.84 | 2.79 |
| | 87914-1425 | ----- | ----- | ----- | 14 | ---- | 5 | 17.78 | 15.24 | 12.25 | 7.00 | 2.96 |
| | 87914-1435 | ----- | ----- | ----- | 14 | ---- | 5 | 17.78 | 15.24 | 13.38 | 6.09 | 5.00 |
| | 87914-1416 | ----- | ----- | ----- | 14 | ---- | 6 | 17.78 | 15.24 | 10.92 | 5.84 | 2.79 |
| | 87914-1426 | ----- | ----- | ----- | 14 | ---- | 6 | 17.78 | 15.24 | 12.25 | 7.00 | 2.96 |
| | 87914-1436 | ----- | ----- | ----- | 14 | ---- | 6 | 17.78 | 15.24 | 13.38 | 6.09 | 5.00 |
| C | 87914-0007 | ----- | ----- | ----- | 14 | ---- | 6 | 17.78 | 15.24 | 13.42 | 8.08 | 3.05 |
| | | | | | | | | | | | | |
| | | | | | | | | | | | | |

| | | | | | | | |
|---|-------------------------------|--|---|--------------|--|------------------------|--|
| PG8. +879140108 EC NO: S2010-0695 DRWN:ATSEE 2010/02/11 CHKD:PTLIM 2004/12/08 APPR:MLONG 2010/06/05 REV DESCRIPTION | QUALITY SYMBOLS | GENERAL TOLERANCES (UNLESS SPECIFIED) | DIMENSION STYLE | SCALE | DESIGN UNITS | THIRD ANGLE PROJECTION | |
| | $F_A=0$ $F_G=0$ $F_P=0$ | mm INCH 4 PLACES ± --- ± --- 3 PLACES ± --- ± --- 2 PLACES ± 0.20 ± --- 1 PLACE ± --- ± --- ANGULAR ± 3 ° | MM ONLY | NTS | METRIC | | |
| | | DRAFT WHERE APPLICABLE MUST REMAIN WITHIN DIMENSIONS | DRAWN BY DATE KCHO 2004/11/05 CHECKED BY DATE PTLIM 2004/12/08 APPROVED BY DATE SCLOW 2004/12/10 | TITLE | 2.54MM PITCH DUAL ROW HEADER SINGLE WAFER, T/H MOLEX INCORPORATED | | |
| | D7 | | SEE TABLE | MATERIAL NO. | DOCUMENT NO. | SHEET NO. | |

| | 10 | | 9 | | 8 | | 7 | | 6 | | 5 | | 4 | | 3 | | 2 | | 1 | |
|---|----------------------------|---|--------------------------------------|--|---|----------|---------------|--------------|-----------|-------|-------|------|------|--|---|--|---|--|---|--|
| | PART NO FOR TRAY PACKAGING | PART NO. FOR TUBE WITHOUT CAP PACKAGING | PART NO. FOR TUBE WITH CAP PACKAGING | PART NO. FOR TAPE & REEL WITHOUT CAP PACKAGING | PART NO. FOR TAPE & REEL WITH CAP PACKAGING | CKT SIZE | VOID POSITION | PLATING TYPE | DIMENSION | | | | | | | | | | | |
| | | | | | | | | | A | B | F | M | P | | | | | | | |
| F | 87914-1611 | ----- | ----- | ----- | ----- | 16 | ----- | 1 | 20.32 | 17.78 | 10.92 | 5.84 | 2.79 | | | | | | | |
| | 87914-1621 | ----- | ----- | ----- | ----- | 16 | ----- | 1 | 20.32 | 17.78 | 12.25 | 7.00 | 2.96 | | | | | | | |
| | 87914-1631 | ----- | ----- | ----- | ----- | 16 | ----- | 1 | 20.32 | 17.78 | 13.38 | 6.09 | 5.00 | | | | | | | |
| | 87914-1612 | ----- | ----- | ----- | ----- | 16 | ----- | 2 | 20.32 | 17.78 | 10.92 | 5.84 | 2.79 | | | | | | | |
| | 87914-1622 | ----- | ----- | ----- | ----- | 16 | ----- | 2 | 20.32 | 17.78 | 12.25 | 7.00 | 2.96 | | | | | | | |
| | 87914-1632 | ----- | ----- | ----- | ----- | 16 | ----- | 2 | 20.32 | 17.78 | 13.38 | 6.09 | 5.00 | | | | | | | |
| E | 87914-1613 | ----- | ----- | ----- | ----- | 16 | ----- | 3 | 20.32 | 17.78 | 10.92 | 5.84 | 2.79 | | | | | | | |
| | 87914-1623 | ----- | ----- | ----- | ----- | 16 | ----- | 3 | 20.32 | 17.78 | 12.25 | 7.00 | 2.96 | | | | | | | |
| | 87914-1633 | ----- | ----- | ----- | ----- | 16 | ----- | 3 | 20.32 | 17.78 | 13.38 | 6.09 | 5.00 | | | | | | | |
| | 87914-1614 | ----- | ----- | ----- | ----- | 16 | ----- | 4 | 20.32 | 17.78 | 10.92 | 5.84 | 2.79 | | | | | | | |
| | 87914-1624 | ----- | ----- | ----- | ----- | 16 | ----- | 4 | 20.32 | 17.78 | 12.25 | 7.00 | 2.96 | | | | | | | |
| | 87914-1634 | ----- | ----- | ----- | ----- | 16 | ----- | 4 | 20.32 | 17.78 | 13.38 | 6.09 | 5.00 | | | | | | | |
| D | 87914-1615 | ----- | ----- | ----- | ----- | 16 | ----- | 5 | 20.32 | 17.78 | 10.92 | 5.84 | 2.79 | | | | | | | |
| | 87914-1625 | ----- | ----- | ----- | ----- | 16 | ----- | 5 | 20.32 | 17.78 | 12.25 | 7.00 | 2.96 | | | | | | | |
| | 87914-1635 | ----- | ----- | ----- | ----- | 16 | ----- | 5 | 20.32 | 17.78 | 13.38 | 6.09 | 5.00 | | | | | | | |
| | 87914-1616 | ----- | ----- | ----- | ----- | 16 | ----- | 6 | 20.32 | 17.78 | 10.92 | 5.84 | 2.79 | | | | | | | |
| | 87914-1626 | ----- | ----- | ----- | ----- | 16 | ----- | 6 | 20.32 | 17.78 | 12.25 | 7.00 | 2.96 | | | | | | | |
| | 87914-1636 | ----- | ----- | ----- | ----- | 16 | ----- | 6 | 20.32 | 17.78 | 13.38 | 6.09 | 5.00 | | | | | | | |
| C | 87914-1600 | ----- | ----- | ----- | ----- | 16 | ----- | 6 | 20.32 | 17.78 | 9.49 | 4.50 | 2.70 | | | | | | | |
| | | | | | | | | | | | | | | | | | | | | |
| | | | | | | | | | | | | | | | | | | | | |
| | | | | | | | | | | | | | | | | | | | | |
| | | | | | | | | | | | | | | | | | | | | |
| | | | | | | | | | | | | | | | | | | | | |
| B | | | | | | | | | | | | | | | | | | | | |

| | | | | | | | | | | | |
|--|--|--|--------------|-----------------------------------|--------------------|--|-------------------------------------|------------------------------|--|--|--|
| PG8. +879140108 EC NO: S2010-0695 DRW:ATSEE 2010/02/11 CHKD:PTLIM 2004/12/08 APPR:MLONG 2010/06/05 D7 | QUALITY SYMBOLS $F_A=0$ $F_G=0$ $F_P=0$ | GENERAL TOLERANCES (UNLESS SPECIFIED) | | DIMENSION STYLE MM ONLY | | SCALE NTS | DESIGN UNITS METRIC | THIRD ANGLE PROJECTION | | | |
| | | 4 PLACES \pm --- \pm --- 3 PLACES \pm --- \pm --- 2 PLACES \pm 0.20 \pm --- 1 PLACE \pm --- \pm --- | mm INCH | DRAWN BY KCHO | DATE 2004/11/05 | TITLE 2.54MM PITCH DUAL ROW HEADER SINGLE WAFER, T/H | | | | | |
| | | ANGULAR \pm 3 ° | | CHECKED BY PTLIM | DATE 2004/12/08 | MOLEX INCORPORATED | | | | | |
| | | DRAFT WHERE APPLICABLE MUST REMAIN WITHIN DIMENSIONS | | APPROVED BY SCLOW | DATE 2004/12/10 | MATERIAL NO. SEE TABLE | DOCUMENT NO. SD-87914-013 | SHEET NO. 14 OF 46 | | | |

| F | 10 | | | | | | | | | | | | | F | | | |
|---|-----------------------------|---|--------------------------------------|--|---|----------|---------------|--------------|-----------|-------|-------|------|------|---|---|---|---|
| | 9 | | | 8 | | 7 | | 6 | 5 | | | 4 | | | 3 | 2 | 1 |
| | PART NO. FOR TRAY PACKAGING | PART NO. FOR TUBE WITHOUT CAP PACKAGING | PART NO. FOR TUBE WITH CAP PACKAGING | PART NO. FOR TAPE & REEL WITHOUT CAP PACKAGING | PART NO. FOR TAPE & REEL WITH CAP PACKAGING | CKT SIZE | VOID POSITION | PLATING TYPE | DIMENSION | | | | | | | | |
| A | | | | | | | | | B | F | M | P | | | | | |
| | 87914-1811 | ----- | ----- | ----- | ----- | 18 | ---- | 1 | 22.86 | 20.32 | 10.92 | 5.84 | 2.79 | | | | |
| | 87914-1821 | ----- | ----- | ----- | ----- | 18 | ---- | 1 | 22.86 | 20.32 | 12.25 | 7.00 | 2.96 | | | | |
| | 87914-1831 | ----- | ----- | ----- | ----- | 18 | ---- | 1 | 22.86 | 20.32 | 13.38 | 6.09 | 5.00 | | | | |
| | 87914-1812 | ----- | ----- | ----- | ----- | 18 | ---- | 2 | 22.86 | 20.32 | 10.92 | 5.84 | 2.79 | | | | |
| | 87914-1822 | ----- | ----- | ----- | ----- | 18 | ---- | 2 | 22.86 | 20.32 | 12.25 | 7.00 | 2.96 | | | | |
| | 87914-1832 | ----- | ----- | ----- | ----- | 18 | ---- | 2 | 22.86 | 20.32 | 13.38 | 6.09 | 5.00 | | | | |
| E | 87914-1813 | ----- | ----- | ----- | ----- | 18 | ---- | 3 | 22.86 | 20.32 | 10.92 | 5.84 | 2.79 | | | | |
| | 87914-1823 | ----- | ----- | ----- | ----- | 18 | ---- | 3 | 22.86 | 20.32 | 12.25 | 7.00 | 2.96 | | | | |
| | 87914-1833 | ----- | ----- | ----- | ----- | 18 | ---- | 3 | 22.86 | 20.32 | 13.38 | 6.09 | 5.00 | | | | |
| | 87914-1814 | ----- | ----- | ----- | ----- | 18 | ---- | 4 | 22.86 | 20.32 | 10.92 | 5.84 | 2.79 | | | | |
| | 87914-1824 | ----- | ----- | ----- | ----- | 18 | ---- | 4 | 22.86 | 20.32 | 12.25 | 7.00 | 2.96 | | | | |
| | 87914-1834 | ----- | ----- | ----- | ----- | 18 | ---- | 4 | 22.86 | 20.32 | 13.38 | 6.09 | 5.00 | | | | |
| D | 87914-1815 | ----- | ----- | ----- | ----- | 18 | ---- | 5 | 22.86 | 20.32 | 10.92 | 5.84 | 2.79 | | | | |
| | 87914-1825 | ----- | ----- | ----- | ----- | 18 | ---- | 5 | 22.86 | 20.32 | 12.25 | 7.00 | 2.96 | | | | |
| | 87914-1835 | ----- | ----- | ----- | ----- | 18 | ---- | 5 | 22.86 | 20.32 | 13.38 | 6.09 | 5.00 | | | | |
| | 87914-1816 | ----- | ----- | ----- | ----- | 18 | ---- | 6 | 22.86 | 20.32 | 10.92 | 5.84 | 2.79 | | | | |
| | 87914-1826 | ----- | ----- | ----- | ----- | 18 | ---- | 6 | 22.86 | 20.32 | 12.25 | 7.00 | 2.96 | | | | |
| | 87914-1836 | ----- | ----- | ----- | ----- | 18 | ---- | 6 | 22.86 | 20.32 | 13.38 | 6.09 | 5.00 | | | | |
| C | | | | | | | | | | | | | | | | | |
| | | | | | | | | | | | | | | | | | |
| | | | | | | | | | | | | | | | | | |
| | | | | | | | | | | | | | | | | | |
| | | | | | | | | | | | | | | | | | |
| | | | | | | | | | | | | | | | | | |
| B | | | | | | | | | | | | | | | | | |
| | | | | | | | | | | | | | | | | | |

| | | | | | | | | | | |
|---|---|-------------|-----------------|--|-----------------|--|--|------------------------|---------|-----|
| A | PG8. +879140108 EC NO: S2010-0695 DRWN:ATSEE 2010/02/11 CHKD:PTLIM 2004/12/08 APPR:MLONG 2010/06/05 | DESCRIPTION | QUALITY SYMBOLS | GENERAL TOLERANCES (UNLESS SPECIFIED) | DIMENSION STYLE | SCALE | DESIGN UNITS | THIRD ANGLE PROJECTION | | |
| | | | $F_A=0$ | | | | | | MM ONLY | NTS |
| | | | $F_G=0$ | | | | | | | |
| | | | $F_P=0$ | | | | | | | |
| | | | | | DRAWN BY | DATE | TITLE | | | |
| | | | | 4 PLACES \pm --- \pm --- | KCHO | 2004/11/05 | 2.54MM PITCH DUAL ROW HEADER SINGLE WAFER, T/H | | | |
| | | | | 3 PLACES \pm --- \pm --- | CHECKED BY | DATE | | | | |
| | | | | 2 PLACES \pm 0.20 \pm --- | PTLIM | 2004/12/08 | | | | |
| | | | | 1 PLACE \pm --- \pm --- | APPROVED BY | DATE | MOLEX INCORPORATED | | | |
| | | | | ANGULAR \pm 3° | SCLOW | 2004/12/10 | | | | |
| | | | | DRAFT WHERE APPLICABLE MUST REMAIN WITHIN DIMENSIONS | MATERIAL NO. | DOCUMENT NO. | SD-87914-013 | | | |
| | | | | SEE TABLE | | | | | | |
| | | | | | SIZE | THIS DRAWING CONTAINS INFORMATION THAT IS PROPRIETARY TO MOLEX INCORPORATED AND SHOULD NOT BE USED WITHOUT WRITTEN PERMISSION | | | | |
| | D7 | REV | | | A3 | SHEET NO. 15 OF 46 | | | | |

| | 10 | 9 | 8 | 7 | 6 | 5 | 4 | 3 | 2 | 1 | | | | |
|---|----------------------------|---|--------------------------------------|--|---|----------|---------------|--------------|-----------|-------|-------|------|------|---|
| | PART NO FOR TRAY PACKAGING | PART NO. FOR TUBE WITHOUT CAP PACKAGING | PART NO. FOR TUBE WITH CAP PACKAGING | PART NO. FOR TAPE & REEL WITHOUT CAP PACKAGING | PART NO. FOR TAPE & REEL WITH CAP PACKAGING | CKT SIZE | VOID POSITION | PLATING TYPE | DIMENSION | | | | | |
| | | | | | | | | A | B | F | M | P | | |
| F | 87914-2011 | ----- | ----- | ----- | ----- | 20 | ---- | 1 | 25.40 | 22.86 | 10.92 | 5.84 | 2.79 | F |
| | 87914-2021 | ----- | ----- | ----- | ----- | 20 | ---- | 1 | 25.40 | 22.86 | 12.25 | 7.00 | 2.96 | |
| | 87914-2031 | ----- | ----- | ----- | ----- | 20 | ---- | 1 | 25.40 | 22.86 | 13.38 | 6.09 | 5.00 | |
| | 87914-2012 | ----- | ----- | ----- | ----- | 20 | ---- | 2 | 25.40 | 22.86 | 10.92 | 5.84 | 2.79 | |
| | 87914-2022 | ----- | ----- | ----- | ----- | 20 | ---- | 2 | 25.40 | 22.86 | 12.25 | 7.00 | 2.96 | |
| | 87914-2032 | ----- | ----- | ----- | ----- | 20 | ---- | 2 | 25.40 | 22.86 | 13.38 | 6.09 | 5.00 | |
| E | 87914-2013 | ----- | ----- | ----- | ----- | 20 | ---- | 3 | 25.40 | 22.86 | 10.92 | 5.84 | 2.79 | E |
| | 87914-2023 | ----- | ----- | ----- | ----- | 20 | ---- | 3 | 25.40 | 22.86 | 12.25 | 7.00 | 2.96 | |
| | 87914-2033 | ----- | ----- | ----- | ----- | 20 | ---- | 3 | 25.40 | 22.86 | 13.38 | 6.09 | 5.00 | |
| | 87914-2014 | ----- | ----- | ----- | ----- | 20 | ---- | 4 | 25.40 | 22.86 | 10.92 | 5.84 | 2.79 | |
| | 87914-2024 | ----- | ----- | ----- | ----- | 20 | ---- | 4 | 25.40 | 22.86 | 12.25 | 7.00 | 2.96 | |
| | 87914-2034 | ----- | ----- | ----- | ----- | 20 | ---- | 4 | 25.40 | 22.86 | 13.38 | 6.09 | 5.00 | |
| D | 87914-2015 | ----- | ----- | ----- | ----- | 20 | ---- | 5 | 25.40 | 22.86 | 10.92 | 5.84 | 2.79 | D |
| | 87914-2025 | ----- | ----- | ----- | ----- | 20 | ---- | 5 | 25.40 | 22.86 | 12.25 | 7.00 | 2.96 | |
| | 87914-2035 | ----- | ----- | ----- | ----- | 20 | ---- | 5 | 25.40 | 22.86 | 13.38 | 6.09 | 5.00 | |
| | 87914-2016 | ----- | ----- | ----- | ----- | 20 | ---- | 6 | 25.40 | 22.86 | 10.92 | 5.84 | 2.79 | |
| | 87914-2026 | ----- | ----- | ----- | ----- | 20 | ---- | 6 | 25.40 | 22.86 | 12.25 | 7.00 | 2.96 | |
| | 87914-2036 | ----- | ----- | ----- | ----- | 20 | ---- | 6 | 25.40 | 22.86 | 13.38 | 6.09 | 5.00 | |
| C | | | | | | | | | | | | | | C |
| | | | | | | | | | | | | | | |
| | | | | | | | | | | | | | | |
| | | | | | | | | | | | | | | |
| | | | | | | | | | | | | | | |
| B | | | | | | | | | | | | | | B |

| PG8. +879140108 EC NO: S2010-0695 DRWN:ATSEE 2010/02/11 CHKD:PTLIM 2004/12/08 APPR:MLONG 2010/06/05 D7 | QUALITY SYMBOLS $F_A=0$ $F_G=0$ $F_P=0$ | GENERAL TOLERANCES (UNLESS SPECIFIED) <table border="1"> <tr><th colspan="2">mm</th><th>INCH</th></tr> <tr><td>4 PLACES</td><td>± ---</td><td>± ---</td></tr> <tr><td>3 PLACES</td><td>± ---</td><td>± ---</td></tr> <tr><td>2 PLACES</td><td>± 0.20</td><td>± ---</td></tr> <tr><td>1 PLACE</td><td>± ---</td><td>± ---</td></tr> </table> | mm | | INCH | 4 PLACES | ± --- | ± --- | 3 PLACES | ± --- | ± --- | 2 PLACES | ± 0.20 | ± --- | 1 PLACE | ± --- | ± --- | DIMENSION STYLE MM ONLY DRAWN BY: KCHO CHECKED BY: PTLIM APPROVED BY: SCLOW MATERIAL NO. | DATE: 2004/11/05 DATE: 2004/12/08 DATE: 2004/12/10 | SCALE: NTS DESIGN UNITS: METRIC THIRD ANGLE PROJECTION | TITLE: 2.54MM PITCH DUAL ROW HEADER SINGLE WAFER, T/H | MOLEX INCORPORATED | DOCUMENT NO.: SD-87914-013 | SHEET NO.: 16 OF 46 |
|---|--|--|---|--|------|----------|-------|-------|----------|-------|-------|----------|--------|-------|---------|-------|-------|--|--|--|---|---------------------------|-----------------------------------|----------------------------|
| | mm | | INCH | | | | | | | | | | | | | | | | | | | | | |
| | 4 PLACES | ± --- | ± --- | | | | | | | | | | | | | | | | | | | | | |
| | 3 PLACES | ± --- | ± --- | | | | | | | | | | | | | | | | | | | | | |
| 2 PLACES | ± 0.20 | ± --- | | | | | | | | | | | | | | | | | | | | | | |
| 1 PLACE | ± --- | ± --- | | | | | | | | | | | | | | | | | | | | | | |
| DRAFT WHERE APPLICABLE MUST REMAIN WITHIN DIMENSIONS | | SEE TABLE | THIS DRAWING CONTAINS INFORMATION THAT IS PROPRIETARY TO MOLEX INCORPORATED AND SHOULD NOT BE USED WITHOUT WRITTEN PERMISSION | | | | | | | | | | | | | | | | | | | | | |
| | | | | | | | | | | | | | | | | | | | | | | | | |
| | | | | | | | | | | | | | | | | | | | | | | | | |

| | 10 | | 9 | | 8 | | 7 | | 6 | | 5 | | 4 | | 3 | | 2 | | 1 | |
|---|----------------------------|---|--------------------------------------|--|---|----------|---------------|--------------|-----------|-------|-------|------|------|--|---|--|---|--|---|--|
| | PART NO FOR TRAY PACKAGING | PART NO. FOR TUBE WITHOUT CAP PACKAGING | PART NO. FOR TUBE WITH CAP PACKAGING | PART NO. FOR TAPE & REEL WITHOUT CAP PACKAGING | PART NO. FOR TAPE & REEL WITH CAP PACKAGING | CKT SIZE | VOID POSITION | PLATING TYPE | DIMENSION | | | | | | | | | | | |
| | | | | | | | | | A | B | F | M | P | | | | | | | |
| F | 87914-2211 | ----- | ----- | ----- | ----- | 22 | ---- | 1 | 27.94 | 25.40 | 10.92 | 5.84 | 2.79 | | | | | | | |
| | 87914-2221 | ----- | ----- | ----- | ----- | 22 | ---- | 1 | 27.94 | 25.40 | 12.25 | 7.00 | 2.96 | | | | | | | |
| | 87914-2231 | ----- | ----- | ----- | ----- | 22 | ---- | 1 | 27.94 | 25.40 | 13.38 | 6.09 | 5.00 | | | | | | | |
| | 87914-2212 | ----- | ----- | ----- | ----- | 22 | ---- | 2 | 27.94 | 25.40 | 10.92 | 5.84 | 2.79 | | | | | | | |
| | 87914-2222 | ----- | ----- | ----- | ----- | 22 | ---- | 2 | 27.94 | 25.40 | 12.25 | 7.00 | 2.96 | | | | | | | |
| | 87914-2232 | ----- | ----- | ----- | ----- | 22 | ---- | 2 | 27.94 | 25.40 | 13.38 | 6.09 | 5.00 | | | | | | | |
| E | 87914-2213 | ----- | ----- | ----- | ----- | 22 | ---- | 3 | 27.94 | 25.40 | 10.92 | 5.84 | 2.79 | | | | | | | |
| | 87914-2223 | ----- | ----- | ----- | ----- | 22 | ---- | 3 | 27.94 | 25.40 | 12.25 | 7.00 | 2.96 | | | | | | | |
| | 87914-2233 | ----- | ----- | ----- | ----- | 22 | ---- | 3 | 27.94 | 25.40 | 13.38 | 6.09 | 5.00 | | | | | | | |
| | 87914-2214 | ----- | ----- | ----- | ----- | 22 | ---- | 4 | 27.94 | 25.40 | 10.92 | 5.84 | 2.79 | | | | | | | |
| | 87914-2224 | ----- | ----- | ----- | ----- | 22 | ---- | 4 | 27.94 | 25.40 | 12.25 | 7.00 | 2.96 | | | | | | | |
| | 87914-2234 | ----- | ----- | ----- | ----- | 22 | ---- | 4 | 27.94 | 25.40 | 13.38 | 6.09 | 5.00 | | | | | | | |
| D | 87914-2215 | ----- | ----- | ----- | ----- | 22 | ---- | 5 | 27.94 | 25.40 | 10.92 | 5.84 | 2.79 | | | | | | | |
| | 87914-2225 | ----- | ----- | ----- | ----- | 22 | ---- | 5 | 27.94 | 25.40 | 12.25 | 7.00 | 2.96 | | | | | | | |
| | 87914-2235 | ----- | ----- | ----- | ----- | 22 | ---- | 5 | 27.94 | 25.40 | 13.38 | 6.09 | 5.00 | | | | | | | |
| | 87914-2216 | ----- | ----- | ----- | ----- | 22 | ---- | 6 | 27.94 | 25.40 | 10.92 | 5.84 | 2.79 | | | | | | | |
| | 87914-2226 | ----- | ----- | ----- | ----- | 22 | ---- | 6 | 27.94 | 25.40 | 12.25 | 7.00 | 2.96 | | | | | | | |
| | 87914-2236 | ----- | ----- | ----- | ----- | 22 | ---- | 6 | 27.94 | 25.40 | 13.38 | 6.09 | 5.00 | | | | | | | |
| C | | | | | | | | | | | | | | | | | | | | |
| | | | | | | | | | | | | | | | | | | | | |
| | | | | | | | | | | | | | | | | | | | | |
| | | | | | | | | | | | | | | | | | | | | |
| | | | | | | | | | | | | | | | | | | | | |
| B | | | | | | | | | | | | | | | | | | | | |
| | | | | | | | | | | | | | | | | | | | | |
| | | | | | | | | | | | | | | | | | | | | |

| PG8. +879140108 EC NO: S2010-0695 DRWN:ATSEE 2010/02/11 CHKD:PTLIM 2004/12/08 APPR:MLONG 2010/06/05 D7 | QUALITY SYMBOLS $F_A=0$ $F_G=0$ $F_P=0$ | GENERAL TOLERANCES (UNLESS SPECIFIED) <table border="1"> <tr><th colspan="2">mm</th><th>INCH</th></tr> <tr><td>4 PLACES</td><td>± ---</td><td>± ---</td></tr> <tr><td>3 PLACES</td><td>± ---</td><td>± ---</td></tr> <tr><td>2 PLACES</td><td>± 0.20</td><td>± ---</td></tr> <tr><td>1 PLACE</td><td>± ---</td><td>± ---</td></tr> </table> | mm | | INCH | 4 PLACES | ± --- | ± --- | 3 PLACES | ± --- | ± --- | 2 PLACES | ± 0.20 | ± --- | 1 PLACE | ± --- | ± --- | DIMENSION STYLE MM ONLY DRAWN BY: KCHO DATE: 2004/11/05 CHECKED BY: PTLIM DATE: 2004/12/08 APPROVED BY: SCLOW DATE: 2004/12/10 | SCALE: NTS DESIGN UNITS: METRIC THIRD ANGLE PROJECTION | TITLE: 2.54MM PITCH DUAL ROW HEADER SINGLE WAFER, T/H |
|---|--|--|---------------------------|---------------------|------|----------|-------|-------|----------|-------|-------|----------|--------|-------|---------|-------|-------|---|--|---|
| | mm | | INCH | | | | | | | | | | | | | | | | | |
| | 4 PLACES | ± --- | ± --- | | | | | | | | | | | | | | | | | |
| | 3 PLACES | ± --- | ± --- | | | | | | | | | | | | | | | | | |
| 2 PLACES | ± 0.20 | ± --- | | | | | | | | | | | | | | | | | | |
| 1 PLACE | ± --- | ± --- | | | | | | | | | | | | | | | | | | |
| | DRAFT WHERE APPLICABLE MUST REMAIN WITHIN DIMENSIONS | MATERIAL NO.: SEE TABLE DOCUMENT NO.: SD-87914-013 | MOLEX INCORPORATED | SHEET NO.: 17 OF 46 | | | | | | | | | | | | | | | | |
| | | SIZE: A3 THIS DRAWING CONTAINS INFORMATION THAT IS PROPRIETARY TO MOLEX INCORPORATED AND SHOULD NOT BE USED WITHOUT WRITTEN PERMISSION | | | | | | | | | | | | | | | | | | |
| | | | | | | | | | | | | | | | | | | | | |

| PART NO FOR TRAY PACKAGING | PART NO. FOR TUBE WITHOUT CAP PACKAGING | PART NO. FOR TUBE WITH CAP PACKAGING | PART NO. FOR TAPE & REEL WITHOUT CAP PACKAGING | PART NO. FOR TAPE & REEL WITH CAP PACKAGING | CKT SIZE | VOID POSITION | PLATING TYPE | DIMENSION | | | | |
|----------------------------|---|--------------------------------------|--|---|----------|---------------|--------------|-----------|------------|-------|-------|-------|
| | | | | | | | | A | B | F | M | P |
| | | | | | | | | F | 87914-2411 | ----- | ----- | ----- |
| | 87914-2421 | ----- | ----- | ----- | 24 | ----- | 1 | 30.48 | 27.94 | 12.25 | 7.00 | 2.96 |
| | 87914-2431 | ----- | ----- | ----- | 24 | ----- | 1 | 30.48 | 27.94 | 13.38 | 6.09 | 5.00 |
| | 87914-2412 | ----- | ----- | ----- | 24 | ----- | 2 | 30.48 | 27.94 | 10.92 | 5.84 | 2.79 |
| | 87914-2422 | ----- | ----- | ----- | 24 | ----- | 2 | 30.48 | 27.94 | 12.25 | 7.00 | 2.96 |
| | 87914-2432 | ----- | ----- | ----- | 24 | ----- | 2 | 30.48 | 27.94 | 13.38 | 6.09 | 5.00 |
| E | 87914-2413 | ----- | ----- | ----- | 24 | ----- | 3 | 30.48 | 27.94 | 10.92 | 5.84 | 2.79 |
| | 87914-2423 | ----- | ----- | ----- | 24 | ----- | 3 | 30.48 | 27.94 | 12.25 | 7.00 | 2.96 |
| | 87914-2433 | ----- | ----- | ----- | 24 | ----- | 3 | 30.48 | 27.94 | 13.38 | 6.09 | 5.00 |
| | 87914-2414 | ----- | ----- | ----- | 24 | ----- | 4 | 30.48 | 27.94 | 10.92 | 5.84 | 2.79 |
| | 87914-2424 | ----- | ----- | ----- | 24 | ----- | 4 | 30.48 | 27.94 | 12.25 | 7.00 | 2.96 |
| | 87914-2434 | ----- | ----- | ----- | 24 | ----- | 4 | 30.48 | 27.94 | 13.38 | 6.09 | 5.00 |
| D | 87914-2415 | ----- | ----- | ----- | 24 | ----- | 5 | 30.48 | 27.94 | 10.92 | 5.84 | 2.79 |
| | 87914-2425 | ----- | ----- | ----- | 24 | ----- | 5 | 30.48 | 27.94 | 12.25 | 7.00 | 2.96 |
| | 87914-2435 | ----- | ----- | ----- | 24 | ----- | 5 | 30.48 | 27.94 | 13.38 | 6.09 | 5.00 |
| | 87914-2416 | ----- | ----- | ----- | 24 | ----- | 6 | 30.48 | 27.94 | 10.92 | 5.84 | 2.79 |
| | 87914-2426 | ----- | ----- | ----- | 24 | ----- | 6 | 30.48 | 27.94 | 12.25 | 7.00 | 2.96 |
| | 87914-2436 | ----- | ----- | ----- | 24 | ----- | 6 | 30.48 | 27.94 | 13.38 | 6.09 | 5.00 |
| C | | | | | | | | | | | | |
| | | | | | | | | | | | | |
| | | | | | | | | | | | | |
| | | | | | | | | | | | | |
| | | | | | | | | | | | | |
| B | | | | | | | | | | | | |
| | | | | | | | | | | | | |
| | | | | | | | | | | | | |

| | | | | | | | | | | | |
|--|--|--|------------|-----------------------------------|--------------------|--|-------------------------------------|------------------------|--|--|--|
| PG8, +879140108 EC NO: S2010-0695 DRWN:ATSEE 2010/02/11 CHKD:PTLIM 2004/12/08 APPR:MLONG 2010/06/05 D7 | QUALITY SYMBOLS $F_A=0$ $F_G=0$ $F_P=0$ | GENERAL TOLERANCES (UNLESS SPECIFIED) | | DIMENSION STYLE MM ONLY | | SCALE NTS | DESIGN UNITS METRIC | THIRD ANGLE PROJECTION | | | |
| | | 4 PLACES ± --- ± --- 3 PLACES ± --- ± --- 2 PLACES ± 0.20 ± --- 1 PLACE ± --- ± --- | mm INCH | DRAWN BY KCHO | DATE 2004/11/05 | TITLE 2.54MM PITCH DUAL ROW HEADER SINGLE WAFER, T/H | | | | | |
| | | ANGULAR ± 3 ° | | CHECKED BY PTLIM | DATE 2004/12/08 | MOLEX INCORPORATED | | | | | |
| | | DRAFT WHERE APPLICABLE MUST REMAIN WITHIN DIMENSIONS | | APPROVED BY SCLOW | DATE 2004/12/10 | MATERIAL NO. SEE TABLE | DOCUMENT NO. SD-87914-013 | SHEET NO. 18 OF 46 | | | |

| PART NO FOR TRAY PACKAGING | PART NO. FOR TUBE WITHOUT CAP PACKAGING | PART NO. FOR TUBE WITH CAP PACKAGING | PART NO. FOR TAPE & REEL WITHOUT CAP PACKAGING | PART NO. FOR TAPE & REEL WITH CAP PACKAGING | CKT SIZE | VOID POSITION | PLATING TYPE | DIMENSION | | | | |
|----------------------------|---|--------------------------------------|--|---|----------|---------------|--------------|-----------|------------|-------|-------|-------|
| | | | | | | | | A | B | F | M | P |
| | | | | | | | | F | 87914-2611 | ----- | ----- | ----- |
| | 87914-2621 | ----- | ----- | ----- | 26 | ---- | 1 | 33.02 | 30.48 | 12.25 | 7.00 | 2.96 |
| | 87914-2631 | ----- | ----- | ----- | 26 | ---- | 1 | 33.02 | 30.48 | 13.38 | 6.09 | 5.00 |
| | 87914-2612 | ----- | ----- | ----- | 26 | ---- | 2 | 33.02 | 30.48 | 10.92 | 5.84 | 2.79 |
| | 87914-2622 | ----- | ----- | ----- | 26 | ---- | 2 | 33.02 | 30.48 | 12.25 | 7.00 | 2.96 |
| | 87914-2632 | ----- | ----- | ----- | 26 | ---- | 2 | 33.02 | 30.48 | 13.38 | 6.09 | 5.00 |
| E | 87914-2613 | ----- | ----- | ----- | 26 | ---- | 3 | 33.02 | 30.48 | 10.92 | 5.84 | 2.79 |
| | 87914-2623 | ----- | ----- | ----- | 26 | ---- | 3 | 33.02 | 30.48 | 12.25 | 7.00 | 2.96 |
| | 87914-2633 | ----- | ----- | ----- | 26 | ---- | 3 | 33.02 | 30.48 | 13.38 | 6.09 | 5.00 |
| | 87914-2614 | ----- | ----- | ----- | 26 | ---- | 4 | 33.02 | 30.48 | 10.92 | 5.84 | 2.79 |
| | 87914-2624 | ----- | ----- | ----- | 26 | ---- | 4 | 33.02 | 30.48 | 12.25 | 7.00 | 2.96 |
| | 87914-2634 | ----- | ----- | ----- | 26 | ---- | 4 | 33.02 | 30.48 | 13.38 | 6.09 | 5.00 |
| D | 87914-2615 | ----- | ----- | ----- | 26 | ---- | 5 | 33.02 | 30.48 | 10.92 | 5.84 | 2.79 |
| | 87914-2625 | ----- | ----- | ----- | 26 | ---- | 5 | 33.02 | 30.48 | 12.25 | 7.00 | 2.96 |
| | 87914-2635 | ----- | ----- | ----- | 26 | ---- | 5 | 33.02 | 30.48 | 13.38 | 6.09 | 5.00 |
| | 87914-2616 | ----- | ----- | ----- | 26 | ---- | 6 | 33.02 | 30.48 | 10.92 | 5.84 | 2.79 |
| | 87914-2626 | ----- | ----- | ----- | 26 | ---- | 6 | 33.02 | 30.48 | 12.25 | 7.00 | 2.96 |
| | 87914-2636 | ----- | ----- | ----- | 26 | ---- | 6 | 33.02 | 30.48 | 13.38 | 6.09 | 5.00 |
| C | | | | | | | | | | | | |
| | | | | | | | | | | | | |
| | | | | | | | | | | | | |
| | | | | | | | | | | | | |
| B | | | | | | | | | | | | |
| | | | | | | | | | | | | |
| | | | | | | | | | | | | |

| | | | | | | | | | |
|--|--|--|------------|-----------------------------------|--------------------|--|-------------------------------------|------------------------|--|
| PG8. +879140108 EC NO: S2010-0695 DRWN:ATSEE 2010/02/11 CHKD:PTLIM 2004/12/08 APPR:MLONG 2010/06/05 D7 | QUALITY SYMBOLS $F_A=0$ $F_C=0$ $F_P=0$ | GENERAL TOLERANCES (UNLESS SPECIFIED) | | DIMENSION STYLE MM ONLY | | SCALE NTS | DESIGN UNITS METRIC | THIRD ANGLE PROJECTION | |
| | | 4 PLACES ± --- ± --- 3 PLACES ± --- ± --- 2 PLACES ± 0.20 ± --- 1 PLACE ± --- ± --- | mm INCH | DRAWN BY KCHO | DATE 2004/11/05 | TITLE 2.54MM PITCH DUAL ROW HEADER SINGLE WAFER, T/H | | | |
| | | ANGULAR ± 3 ° | | CHECKED BY PTLIM | DATE 2004/12/08 | MOLEX INCORPORATED | | | |
| | | DRAFT WHERE APPLICABLE MUST REMAIN WITHIN DIMENSIONS | | APPROVED BY SCLOW | DATE 2004/12/10 | MATERIAL NO. SEE TABLE | DOCUMENT NO. SD-87914-013 | SHEET NO. 19 OF 46 | |

| | 10 | | 9 | | 8 | | 7 | | 6 | | 5 | | 4 | | 3 | | 2 | | 1 | | |
|---|----------------------------|---|--------------------------------------|--|---|----------|---------------|--------------|-----------|-------|-------|------|------|--|---|--|---|--|---|--|--|
| | PART NO FOR TRAY PACKAGING | PART NO. FOR TUBE WITHOUT CAP PACKAGING | PART NO. FOR TUBE WITH CAP PACKAGING | PART NO. FOR TAPE & REEL WITHOUT CAP PACKAGING | PART NO. FOR TAPE & REEL WITH CAP PACKAGING | CKT SIZE | VOID POSITION | PLATING TYPE | DIMENSION | | | | | | | | | | | | |
| | | | | | | | | | A | B | F | M | P | | | | | | | | |
| F | 87914-2811 | ----- | ----- | ----- | ----- | 28 | ----- | 1 | 35.56 | 33.02 | 10.92 | 5.84 | 2.79 | | | | | | | | |
| | 87914-2821 | ----- | ----- | ----- | ----- | 28 | ----- | 1 | 35.56 | 33.02 | 12.25 | 7.00 | 2.96 | | | | | | | | |
| | 87914-2831 | ----- | ----- | ----- | ----- | 28 | ----- | 1 | 35.56 | 33.02 | 13.38 | 6.09 | 5.00 | | | | | | | | |
| | 87914-2812 | ----- | ----- | ----- | ----- | 28 | ----- | 2 | 35.56 | 33.02 | 10.92 | 5.84 | 2.79 | | | | | | | | |
| | 87914-2822 | ----- | ----- | ----- | ----- | 28 | ----- | 2 | 35.56 | 33.02 | 12.25 | 7.00 | 2.96 | | | | | | | | |
| | 87914-2832 | ----- | ----- | ----- | ----- | 28 | ----- | 2 | 35.56 | 33.02 | 13.38 | 6.09 | 5.00 | | | | | | | | |
| E | 87914-2813 | ----- | ----- | ----- | ----- | 28 | ----- | 3 | 35.56 | 33.02 | 10.92 | 5.84 | 2.79 | | | | | | | | |
| | 87914-2823 | ----- | ----- | ----- | ----- | 28 | ----- | 3 | 35.56 | 33.02 | 12.25 | 7.00 | 2.96 | | | | | | | | |
| | 87914-2833 | ----- | ----- | ----- | ----- | 28 | ----- | 3 | 35.56 | 33.02 | 13.38 | 6.09 | 5.00 | | | | | | | | |
| | 87914-2814 | ----- | ----- | ----- | ----- | 28 | ----- | 4 | 35.56 | 33.02 | 10.92 | 5.84 | 2.79 | | | | | | | | |
| | 87914-2824 | ----- | ----- | ----- | ----- | 28 | ----- | 4 | 35.56 | 33.02 | 12.25 | 7.00 | 2.96 | | | | | | | | |
| | 87914-2834 | ----- | ----- | ----- | ----- | 28 | ----- | 4 | 35.56 | 33.02 | 13.38 | 6.09 | 5.00 | | | | | | | | |
| D | 87914-2815 | ----- | ----- | ----- | ----- | 28 | ----- | 5 | 35.56 | 33.02 | 10.92 | 5.84 | 2.79 | | | | | | | | |
| | 87914-2825 | ----- | ----- | ----- | ----- | 28 | ----- | 5 | 35.56 | 33.02 | 12.25 | 7.00 | 2.96 | | | | | | | | |
| | 87914-2835 | ----- | ----- | ----- | ----- | 28 | ----- | 5 | 35.56 | 33.02 | 13.38 | 6.09 | 5.00 | | | | | | | | |
| | 87914-2816 | ----- | ----- | ----- | ----- | 28 | ----- | 6 | 35.56 | 33.02 | 10.92 | 5.84 | 2.79 | | | | | | | | |
| | 87914-2826 | ----- | ----- | ----- | ----- | 28 | ----- | 6 | 35.56 | 33.02 | 12.25 | 7.00 | 2.96 | | | | | | | | |
| | 87914-2836 | ----- | ----- | ----- | ----- | 28 | ----- | 6 | 35.56 | 33.02 | 13.38 | 6.09 | 5.00 | | | | | | | | |
| C | | | | | | | | | | | | | | | | | | | | | |
| | | | | | | | | | | | | | | | | | | | | | |
| | | | | | | | | | | | | | | | | | | | | | |
| | | | | | | | | | | | | | | | | | | | | | |
| B | | | | | | | | | | | | | | | | | | | | | |
| | | | | | | | | | | | | | | | | | | | | | |
| | | | | | | | | | | | | | | | | | | | | | |

| | | | | | | | | |
|--|---------------------------------|--|---|-----------------|---|--------------|--|---|
| PG8. +879140108 EC NO: S2010-0695 DRWN:ATSEE 2010/02/11 CHKD:PTLIM 2004/12/08 APPR:MLONG 2010/06/05 | DESCRIPTION REV D7 | QUALITY SYMBOLS | GENERAL TOLERANCES (UNLESS SPECIFIED) | DIMENSION STYLE | SCALE | DESIGN UNITS | THIRD ANGLE PROJECTION | |
| | | $F_A=0$ $F_G=0$ $F_P=0$ | mm INCH 4 PLACES ± --- ± --- 3 PLACES ± --- ± --- 2 PLACES ± 0.20 ± --- 1 PLACE ± --- ± --- ANGULAR ± 3 ° | MM ONLY | NTS | METRIC | DRAWN BY: KCHO DATE: 2004/11/05 CHECKED BY: PTLIM DATE: 2004/12/08 APPROVED BY: SCLOW DATE: 2004/12/10 | TITLE: 2.54MM PITCH DUAL ROW HEADER SINGLE WAFER, T/H MOLEX INCORPORATED |
| | | DRAFT WHERE APPLICABLE MUST REMAIN WITHIN DIMENSIONS | | SEE TABLE | MATERIAL NO. | DOCUMENT NO. | SHEET NO. | |
| | | | | SIZE: A3 | THIS DRAWING CONTAINS INFORMATION THAT IS PROPRIETARY TO MOLEX INCORPORATED AND SHOULD NOT BE USED WITHOUT WRITTEN PERMISSION | | | |

| PART NO FOR TRAY PACKAGING | PART NO. FOR TUBE WITHOUT CAP PACKAGING | PART NO. FOR TUBE WITH CAP PACKAGING | PART NO. FOR TAPE & REEL WITHOUT CAP PACKAGING | PART NO. FOR TAPE & REEL WITH CAP PACKAGING | CKT SIZE | VOID POSITION | PLATING TYPE | DIMENSION | | | | |
|----------------------------|---|--------------------------------------|--|---|----------|---------------|--------------|-----------|------------|-------|-------|-------|
| | | | | | | | | A | B | F | M | P |
| | | | | | | | | F | 87914-3011 | ----- | ----- | ----- |
| | 87914-3021 | ----- | ----- | ----- | 30 | ---- | 1 | 38.10 | 35.56 | 12.25 | 7.00 | 2.96 |
| | 87914-3031 | ----- | ----- | ----- | 30 | ---- | 1 | 38.10 | 35.56 | 13.38 | 6.09 | 5.00 |
| | 87914-3012 | ----- | ----- | ----- | 30 | ---- | 2 | 38.10 | 35.56 | 10.92 | 5.84 | 2.79 |
| | 87914-3022 | ----- | ----- | ----- | 30 | ---- | 2 | 38.10 | 35.56 | 12.25 | 7.00 | 2.96 |
| | 87914-3032 | ----- | ----- | ----- | 30 | ---- | 2 | 38.10 | 35.56 | 13.38 | 6.09 | 5.00 |
| E | 87914-3013 | ----- | ----- | ----- | 30 | ---- | 3 | 38.10 | 35.56 | 10.92 | 5.84 | 2.79 |
| | 87914-3023 | ----- | ----- | ----- | 30 | ---- | 3 | 38.10 | 35.56 | 12.25 | 7.00 | 2.96 |
| | 87914-3033 | ----- | ----- | ----- | 30 | ---- | 3 | 38.10 | 35.56 | 13.38 | 6.09 | 5.00 |
| | 87914-3014 | ----- | ----- | ----- | 30 | ---- | 4 | 38.10 | 35.56 | 10.92 | 5.84 | 2.79 |
| | 87914-3024 | ----- | ----- | ----- | 30 | ---- | 4 | 38.10 | 35.56 | 12.25 | 7.00 | 2.96 |
| | 87914-3034 | ----- | ----- | ----- | 30 | ---- | 4 | 38.10 | 35.56 | 13.38 | 6.09 | 5.00 |
| D | 87914-3015 | ----- | ----- | ----- | 30 | ---- | 5 | 38.10 | 35.56 | 10.92 | 5.84 | 2.79 |
| | 87914-3025 | ----- | ----- | ----- | 30 | ---- | 5 | 38.10 | 35.56 | 12.25 | 7.00 | 2.96 |
| | 87914-3035 | ----- | ----- | ----- | 30 | ---- | 5 | 38.10 | 35.56 | 13.38 | 6.09 | 5.00 |
| | 87914-3016 | ----- | ----- | ----- | 30 | ---- | 6 | 38.10 | 35.56 | 10.92 | 5.84 | 2.79 |
| | 87914-3026 | ----- | ----- | ----- | 30 | ---- | 6 | 38.10 | 35.56 | 12.25 | 7.00 | 2.96 |
| | 87914-3036 | ----- | ----- | ----- | 30 | ---- | 6 | 38.10 | 35.56 | 13.38 | 6.09 | 5.00 |
| C | | | | | | | | | | | | |
| | | | | | | | | | | | | |
| | | | | | | | | | | | | |
| | | | | | | | | | | | | |
| | | | | | | | | | | | | |
| B | | | | | | | | | | | | |
| | | | | | | | | | | | | |
| | | | | | | | | | | | | |

| | | | | | | |
|--|-------------------------------|--|--|-------|--|------------------------|
| PG8. +879140108 EC NO: S2010-0695 DRWN:ATSEE 2010/02/11 CHKD:PTLIM 2004/12/08 APPR:MLONG 2010/06/05 REV D7 | QUALITY SYMBOLS | GENERAL TOLERANCES (UNLESS SPECIFIED) | DIMENSION STYLE | SCALE | DESIGN UNITS | THIRD ANGLE PROJECTION |
| | $F_A=0$ $F_G=0$ $F_P=0$ | mm INCH 4 PLACES ± --- ± --- 3 PLACES ± --- ± --- 2 PLACES ± 0.20 ± --- 1 PLACE ± --- ± --- ANGULAR ± 3 ° | MM ONLY | NTS | METRIC | |
| | | DRAFT WHERE APPLICABLE MUST REMAIN WITHIN DIMENSIONS | DRAWN BY DATE KCHO 2004/11/05 CHECKED BY DATE PTLIM 2004/12/08 APPROVED BY DATE SCLOW 2004/12/10 MATERIAL NO. SEE TABLE DOCUMENT NO. SD-87914-013 | TITLE | 2.54MM PITCH DUAL ROW HEADER SINGLE WAFER, T/H MOLEX INCORPORATED | |
| | | | SIZE A3 THIS DRAWING CONTAINS INFORMATION THAT IS PROPRIETARY TO MOLEX INCORPORATED AND SHOULD NOT BE USED WITHOUT WRITTEN PERMISSION | | | SHEET NO. 21 OF 46 |

| 10 | | 9 | | 8 | | 7 | | 6 | | 5 | | 4 | | 3 | | 2 | | 1 | |
|----------------------------|---|--------------------------------------|--|---|----------|---------------|--------------|-----------|-------|-------|-------|------|------|---|--|---|--|---|--|
| PART NO FOR TRAY PACKAGING | PART NO. FOR TUBE WITHOUT CAP PACKAGING | PART NO. FOR TUBE WITH CAP PACKAGING | PART NO. FOR TAPE & REEL WITHOUT CAP PACKAGING | PART NO. FOR TAPE & REEL WITH CAP PACKAGING | CKT SIZE | VOID POSITION | PLATING TYPE | DIMENSION | | | | | | | | | | | |
| | | | | | | | | A | B | F | M | P | | | | | | | |
| F | 87914-3211 | ----- | ----- | ----- | ----- | 32 | ---- | 1 | 40.64 | 38.10 | 10.92 | 5.84 | 2.79 | | | | | | |
| | 87914-3221 | ----- | ----- | ----- | ----- | 32 | ---- | 1 | 40.64 | 38.10 | 12.25 | 7.00 | 2.96 | | | | | | |
| | 87914-3231 | ----- | ----- | ----- | ----- | 32 | ---- | 1 | 40.64 | 38.10 | 13.38 | 6.09 | 5.00 | | | | | | |
| | 87914-3212 | ----- | ----- | ----- | ----- | 32 | ---- | 2 | 40.64 | 38.10 | 10.92 | 5.84 | 2.79 | | | | | | |
| | 87914-3222 | ----- | ----- | ----- | ----- | 32 | ---- | 2 | 40.64 | 38.10 | 12.25 | 7.00 | 2.96 | | | | | | |
| | 87914-3232 | ----- | ----- | ----- | ----- | 32 | ---- | 2 | 40.64 | 38.10 | 13.38 | 6.09 | 5.00 | | | | | | |
| E | 87914-3213 | ----- | ----- | ----- | ----- | 32 | ---- | 3 | 40.64 | 38.10 | 10.92 | 5.84 | 2.79 | | | | | | |
| | 87914-3223 | ----- | ----- | ----- | ----- | 32 | ---- | 3 | 40.64 | 38.10 | 12.25 | 7.00 | 2.96 | | | | | | |
| | 87914-3233 | ----- | ----- | ----- | ----- | 32 | ---- | 3 | 40.64 | 38.10 | 13.38 | 6.09 | 5.00 | | | | | | |
| | 87914-3214 | ----- | ----- | ----- | ----- | 32 | ---- | 4 | 40.64 | 38.10 | 10.92 | 5.84 | 2.79 | | | | | | |
| | 87914-3224 | ----- | ----- | ----- | ----- | 32 | ---- | 4 | 40.64 | 38.10 | 12.25 | 7.00 | 2.96 | | | | | | |
| | 87914-3234 | ----- | ----- | ----- | ----- | 32 | ---- | 4 | 40.64 | 38.10 | 13.38 | 6.09 | 5.00 | | | | | | |
| D | 87914-3215 | ----- | ----- | ----- | ----- | 32 | ---- | 5 | 40.64 | 38.10 | 10.92 | 5.84 | 2.79 | | | | | | |
| | 87914-3225 | ----- | ----- | ----- | ----- | 32 | ---- | 5 | 40.64 | 38.10 | 12.25 | 7.00 | 2.96 | | | | | | |
| | 87914-3235 | ----- | ----- | ----- | ----- | 32 | ---- | 5 | 40.64 | 38.10 | 13.38 | 6.09 | 5.00 | | | | | | |
| | 87914-3216 | ----- | ----- | ----- | ----- | 32 | ---- | 6 | 40.64 | 38.10 | 10.92 | 5.84 | 2.79 | | | | | | |
| | 87914-3226 | ----- | ----- | ----- | ----- | 32 | ---- | 6 | 40.64 | 38.10 | 12.25 | 7.00 | 2.96 | | | | | | |
| | 87914-3236 | ----- | ----- | ----- | ----- | 32 | ---- | 6 | 40.64 | 38.10 | 13.38 | 6.09 | 5.00 | | | | | | |
| C | | | | | | | | | | | | | | | | | | | |
| | | | | | | | | | | | | | | | | | | | |
| | | | | | | | | | | | | | | | | | | | |
| | | | | | | | | | | | | | | | | | | | |
| B | | | | | | | | | | | | | | | | | | | |

| PG8. +879140108 EC NO: S2010-0695 DRWN:ATSEE 2010/02/11 CHKD:PTLIM 2004/12/08 APPR:MLONG 2010/06/05 | D7 REV | QUALITY SYMBOLS $F_A=0$ $F_G=0$ $F_P=0$ | GENERAL TOLERANCES (UNLESS SPECIFIED) <table border="1"> <tr> <th></th> <th>mm</th> <th>INCH</th> </tr> <tr> <td>4 PLACES</td> <td>\pm ---</td> <td>\pm ---</td> </tr> <tr> <td>3 PLACES</td> <td>\pm ---</td> <td>\pm ---</td> </tr> <tr> <td>2 PLACES</td> <td>\pm 0.20</td> <td>\pm ---</td> </tr> <tr> <td>1 PLACE</td> <td>\pm ---</td> <td>\pm ---</td> </tr> </table> | | mm | INCH | 4 PLACES | \pm --- | \pm --- | 3 PLACES | \pm --- | \pm --- | 2 PLACES | \pm 0.20 | \pm --- | 1 PLACE | \pm --- | \pm --- | DIMENSION STYLE MM ONLY | SCALE NTS | DESIGN UNITS METRIC | | TITLE 2.54MM PITCH DUAL ROW HEADER SINGLE WAFER, T/H |
|--|------------------|--|---|--|----|------|----------|------------------------------|-----------|----------|-----------|-----------|----------|------------|-----------|---------|-----------|-----------|-----------------------------------|---------------------|-------------------------------|--|--|
| | | | | | mm | INCH | | | | | | | | | | | | | | | | | |
| 4 PLACES | \pm --- | \pm --- | | | | | | | | | | | | | | | | | | | | | |
| 3 PLACES | \pm --- | \pm --- | | | | | | | | | | | | | | | | | | | | | |
| 2 PLACES | \pm 0.20 | \pm --- | | | | | | | | | | | | | | | | | | | | | |
| 1 PLACE | \pm --- | \pm --- | | | | | | | | | | | | | | | | | | | | | |
| DRAWN BY: KCHO DATE: 2004/11/05 CHECKED BY: PTLIM DATE: 2004/12/08 APPROVED BY: SCLOW DATE: 2004/12/10 MATERIAL NO.: SEE TABLE DOCUMENT NO.: SD-87914-013 | | | | | | | | | | | | | | | | | | | | | | | |
| DRAFT WHERE APPLICABLE MUST REMAIN WITHIN DIMENSIONS | | | | | | | | SHEET NO. 22 OF 46 | | | | | | | | | | | | | | | |

| F | PART NO FOR TRAY PACKAGING | PART NO. FOR TUBE WITHOUT CAP PACKAGING | PART NO. FOR TUBE WITH CAP PACKAGING | PART NO. FOR TAPE & REEL WITHOUT CAP PACKAGING | PART NO. FOR TAPE & REEL WITH CAP PACKAGING | CKT SIZE | VOID POSITION | PLATING TYPE | DIMENSION | | | | |
|------------|----------------------------|---|--------------------------------------|--|---|----------|---------------|--------------|------------|-------|-------|-------|-------|
| | | | | | | | | | A | B | F | M | P |
| | | | | | | | | | 87914-3611 | ----- | ----- | ----- | ----- |
| 87914-3621 | ----- | ----- | ----- | ----- | 36 | ----- | 1 | 45.72 | 43.18 | 12.25 | 7.00 | 2.96 | |
| 87914-3631 | ----- | ----- | ----- | ----- | 36 | ----- | 1 | 45.72 | 43.18 | 13.38 | 6.09 | 5.00 | |
| 87914-3612 | ----- | ----- | ----- | ----- | 36 | ----- | 2 | 45.72 | 43.18 | 10.92 | 5.84 | 2.79 | |
| 87914-3622 | ----- | ----- | ----- | ----- | 36 | ----- | 2 | 45.72 | 43.18 | 12.25 | 7.00 | 2.96 | |
| 87914-3632 | ----- | ----- | ----- | ----- | 36 | ----- | 2 | 45.72 | 43.18 | 13.38 | 6.09 | 5.00 | |
| 87914-3613 | ----- | ----- | ----- | ----- | 36 | ----- | 3 | 45.72 | 43.18 | 10.92 | 5.84 | 2.79 | |
| 87914-3623 | ----- | ----- | ----- | ----- | 36 | ----- | 3 | 45.72 | 43.18 | 12.25 | 7.00 | 2.96 | |
| 87914-3633 | ----- | ----- | ----- | ----- | 36 | ----- | 3 | 45.72 | 43.18 | 13.38 | 6.09 | 5.00 | |
| 87914-3614 | ----- | ----- | ----- | ----- | 36 | ----- | 4 | 45.72 | 43.18 | 10.92 | 5.84 | 2.79 | |
| 87914-3624 | ----- | ----- | ----- | ----- | 36 | ----- | 4 | 45.72 | 43.18 | 12.25 | 7.00 | 2.96 | |
| 87914-3634 | ----- | ----- | ----- | ----- | 36 | ----- | 4 | 45.72 | 43.18 | 13.38 | 6.09 | 5.00 | |
| 87914-3615 | ----- | ----- | ----- | ----- | 36 | ----- | 5 | 45.72 | 43.18 | 10.92 | 5.84 | 2.79 | |
| 87914-3625 | ----- | ----- | ----- | ----- | 36 | ----- | 5 | 45.72 | 43.18 | 12.25 | 7.00 | 2.96 | |
| 87914-3635 | ----- | ----- | ----- | ----- | 36 | ----- | 5 | 45.72 | 43.18 | 13.38 | 6.09 | 5.00 | |
| 87914-3616 | ----- | ----- | ----- | ----- | 36 | ----- | 6 | 45.72 | 43.18 | 10.92 | 5.84 | 2.79 | |
| 87914-3626 | ----- | ----- | ----- | ----- | 36 | ----- | 6 | 45.72 | 43.18 | 12.25 | 7.00 | 2.96 | |
| 87914-3636 | ----- | ----- | ----- | ----- | 36 | ----- | 6 | 45.72 | 43.18 | 13.38 | 6.09 | 5.00 | |
| 87914-3637 | ----- | ----- | ----- | ----- | 36 | ----- | 6 | 45.72 | 43.18 | 12.10 | 7.21 | 2.60 | |

| PG8. +879140108 EC NO: S2010-0695 DRW:ATSEE 2010/02/11 CHKD:PTLIM 2004/12/08 APPR:MLONG 2010/06/05 D7 | QUALITY SYMBOLS $\nabla_A = 0$ $\nabla_C = 0$ $\nabla_P = 0$ | GENERAL TOLERANCES (UNLESS SPECIFIED) <table border="1"> <tr> <th></th> <th>mm</th> <th>INCH</th> </tr> <tr> <td>4 PLACES</td> <td>\pm ---</td> <td>\pm ---</td> </tr> <tr> <td>3 PLACES</td> <td>\pm ---</td> <td>\pm ---</td> </tr> <tr> <td>2 PLACES</td> <td>\pm 0.20</td> <td>\pm ---</td> </tr> <tr> <td>1 PLACE</td> <td>\pm ---</td> <td>\pm ---</td> </tr> </table> | | mm | INCH | 4 PLACES | \pm --- | \pm --- | 3 PLACES | \pm --- | \pm --- | 2 PLACES | \pm 0.20 | \pm --- | 1 PLACE | \pm --- | \pm --- | DIMENSION STYLE MM ONLY DRAWN BY: KCHO DATE: 2004/11/05 CHECKED BY: PTLIM DATE: 2004/12/08 APPROVED BY: SCLOW DATE: 2004/12/10 | SCALE NTS DESIGN UNITS METRIC | THIRD ANGLE PROJECTION | 2.54MM PITCH DUAL ROW HEADER SINGLE WAFER, T/H MOLEX INCORPORATED MATERIAL NO. SEE TABLE DOCUMENT NO. SD-87914-013 SHEET NO. 24 OF 46 |
|--|--|--|------------------|--|------|----------|-----------|-----------|----------|-----------|-----------|----------|------------|-----------|---------|-----------|-----------|---|--|-------------------------------|---|
| | | mm | INCH | | | | | | | | | | | | | | | | | | |
| | 4 PLACES | \pm --- | \pm --- | | | | | | | | | | | | | | | | | | |
| 3 PLACES | \pm --- | \pm --- | | | | | | | | | | | | | | | | | | | |
| 2 PLACES | \pm 0.20 | \pm --- | | | | | | | | | | | | | | | | | | | |
| 1 PLACE | \pm --- | \pm --- | | | | | | | | | | | | | | | | | | | |
| ANGULAR $\pm 3^\circ$ | | DRAFT WHERE APPLICABLE MUST REMAIN WITHIN DIMENSIONS | SEE TABLE | THIS DRAWING CONTAINS INFORMATION THAT IS PROPRIETARY TO MOLEX INCORPORATED AND SHOULD NOT BE USED WITHOUT WRITTEN PERMISSION | | | | | | | | | | | | | | | | | |
| | | | | | | | | | | | | | | | | | | | | | |

| F | 10 | 9 | 8 | 7 | 6 | 5 | 4 | 3 | 2 | 1 | | | |
|---|----------------------------|---|--------------------------------------|--|---|----------|---------------|--------------|-----------|-------|-------|------|------|
| | PART NO FOR TRAY PACKAGING | PART NO. FOR TUBE WITHOUT CAP PACKAGING | PART NO. FOR TUBE WITH CAP PACKAGING | PART NO. FOR TAPE & REEL WITHOUT CAP PACKAGING | PART NO. FOR TAPE & REEL WITH CAP PACKAGING | CKT SIZE | VOID POSITION | PLATING TYPE | DIMENSION | | | | |
| | | | | | | | | | A | B | F | M | P |
| | 87914-3811 | ----- | ----- | ----- | ----- | 38 | ---- | 1 | 48.26 | 45.72 | 10.92 | 5.84 | 2.79 |
| | 87914-3821 | ----- | ----- | ----- | ----- | 38 | ---- | 1 | 48.26 | 45.72 | 12.25 | 7.00 | 2.96 |
| | 87914-3831 | ----- | ----- | ----- | ----- | 38 | ---- | 1 | 48.26 | 45.72 | 13.38 | 6.09 | 5.00 |
| | 87914-3812 | ----- | ----- | ----- | ----- | 38 | ---- | 2 | 48.26 | 45.72 | 10.92 | 5.84 | 2.79 |
| | 87914-3822 | ----- | ----- | ----- | ----- | 38 | ---- | 2 | 48.26 | 45.72 | 12.25 | 7.00 | 2.96 |
| | 87914-3832 | ----- | ----- | ----- | ----- | 38 | ---- | 2 | 48.26 | 45.72 | 13.38 | 6.09 | 5.00 |
| E | 87914-3813 | ----- | ----- | ----- | ----- | 38 | ---- | 3 | 48.26 | 45.72 | 10.92 | 5.84 | 2.79 |
| | 87914-3823 | ----- | ----- | ----- | ----- | 38 | ---- | 3 | 48.26 | 45.72 | 12.25 | 7.00 | 2.96 |
| | 87914-3833 | ----- | ----- | ----- | ----- | 38 | ---- | 3 | 48.26 | 45.72 | 13.38 | 6.09 | 5.00 |
| | 87914-3814 | ----- | ----- | ----- | ----- | 38 | ---- | 4 | 48.26 | 45.72 | 10.92 | 5.84 | 2.79 |
| | 87914-3824 | ----- | ----- | ----- | ----- | 38 | ---- | 4 | 48.26 | 45.72 | 12.25 | 7.00 | 2.96 |
| | 87914-3834 | ----- | ----- | ----- | ----- | 38 | ---- | 4 | 48.26 | 45.72 | 13.38 | 6.09 | 5.00 |
| D | 87914-3815 | ----- | ----- | ----- | ----- | 38 | ---- | 5 | 48.26 | 45.72 | 10.92 | 5.84 | 2.79 |
| | 87914-3825 | ----- | ----- | ----- | ----- | 38 | ---- | 5 | 48.26 | 45.72 | 12.25 | 7.00 | 2.96 |
| | 87914-3835 | ----- | ----- | ----- | ----- | 38 | ---- | 5 | 48.26 | 45.72 | 13.38 | 6.09 | 5.00 |
| | 87914-3816 | ----- | ----- | ----- | ----- | 38 | ---- | 6 | 48.26 | 45.72 | 10.92 | 5.84 | 2.79 |
| | 87914-3826 | ----- | ----- | ----- | ----- | 38 | ---- | 6 | 48.26 | 45.72 | 12.25 | 7.00 | 2.96 |
| | 87914-3836 | ----- | ----- | ----- | ----- | 38 | ---- | 6 | 48.26 | 45.72 | 13.38 | 6.09 | 5.00 |
| C | | | | | | | | | | | | | |
| | | | | | | | | | | | | | |
| | | | | | | | | | | | | | |
| | | | | | | | | | | | | | |
| | | | | | | | | | | | | | |
| B | | | | | | | | | | | | | |

| | | | | | | | | | | | |
|--|--|---------------------------------------|------------|--|--------------------|---|-------------------------------------|------------------------------|--|--|--|
| PG8. +879140108 EC NO: S2010-0695 DRWN:ATSEE 2010/02/11 CHKD:PTLIM 2004/12/08 APPR:MLONG 2010/06/05 D7 | QUALITY SYMBOLS $F_A=0$ $F_C=0$ $F_P=0$ | GENERAL TOLERANCES (UNLESS SPECIFIED) | | DIMENSION STYLE MM ONLY | | SCALE NTS | DESIGN UNITS METRIC | THIRD ANGLE PROJECTION | | | |
| | | 4 PLACES ± --- ± --- | mm INCH | DRAWN BY KCHO | DATE 2004/11/05 | TITLE 2.54MM PITCH DUAL ROW HEADER SINGLE WAFER, T/H | | | | | |
| | | 3 PLACES ± --- ± --- | | CHECKED BY PTLIM | DATE 2004/12/08 | MOLEX INCORPORATED | | | | | |
| | | 2 PLACES ± 0.20 ± --- | | APPROVED BY SCLOW | DATE 2004/12/10 | MATERIAL NO. SEE TABLE | DOCUMENT NO. SD-87914-013 | SHEET NO. 25 OF 46 | | | |
| 1 PLACE ± --- ± --- | | ANGULAR ± 3 ° | | DRAFT WHERE APPLICABLE MUST REMAIN WITHIN DIMENSIONS | | THIS DRAWING CONTAINS INFORMATION THAT IS PROPRIETARY TO MOLEX INCORPORATED AND SHOULD NOT BE USED WITHOUT WRITTEN PERMISSION | | | | | |

| | 10 | 9 | 8 | 7 | 6 | 5 | 4 | 3 | 2 | 1 | | | |
|---|----------------------------|---|--------------------------------------|--|---|----------|---------------|--------------|-----------|-------|-------|------|------|
| | PART NO FOR TRAY PACKAGING | PART NO. FOR TUBE WITHOUT CAP PACKAGING | PART NO. FOR TUBE WITH CAP PACKAGING | PART NO. FOR TAPE & REEL WITHOUT CAP PACKAGING | PART NO. FOR TAPE & REEL WITH CAP PACKAGING | CKT SIZE | VOID POSITION | PLATING TYPE | DIMENSION | | | | |
| | | | | | | | | | A | B | F | M | P |
| F | 87914-4011 | ----- | ----- | ----- | ----- | 40 | ---- | 1 | 50.80 | 48.26 | 10.92 | 5.84 | 2.79 |
| | 87914-4021 | ----- | ----- | ----- | ----- | 40 | ---- | 1 | 50.80 | 48.26 | 12.25 | 7.00 | 2.96 |
| | 87914-4031 | ----- | ----- | ----- | ----- | 40 | ---- | 1 | 50.80 | 48.26 | 13.38 | 6.09 | 5.00 |
| | 87914-4012 | ----- | ----- | ----- | ----- | 40 | ---- | 2 | 50.80 | 48.26 | 10.92 | 5.84 | 2.79 |
| | 87914-4022 | ----- | ----- | ----- | ----- | 40 | ---- | 2 | 50.80 | 48.26 | 12.25 | 7.00 | 2.96 |
| | 87914-4032 | ----- | ----- | ----- | ----- | 40 | ---- | 2 | 50.80 | 48.26 | 13.38 | 6.09 | 5.00 |
| E | 87914-4013 | ----- | ----- | ----- | ----- | 40 | ---- | 3 | 50.80 | 48.26 | 10.92 | 5.84 | 2.79 |
| | 87914-4023 | ----- | ----- | ----- | ----- | 40 | ---- | 3 | 50.80 | 48.26 | 12.25 | 7.00 | 2.96 |
| | 87914-4033 | ----- | ----- | ----- | ----- | 40 | ---- | 3 | 50.80 | 48.26 | 13.38 | 6.09 | 5.00 |
| | 87914-4014 | ----- | ----- | ----- | ----- | 40 | ---- | 4 | 50.80 | 48.26 | 10.92 | 5.84 | 2.79 |
| | 87914-4024 | ----- | ----- | ----- | ----- | 40 | ---- | 4 | 50.80 | 48.26 | 12.25 | 7.00 | 2.96 |
| | 87914-4034 | ----- | ----- | ----- | ----- | 40 | ---- | 4 | 50.80 | 48.26 | 13.38 | 6.09 | 5.00 |
| D | 87914-4015 | ----- | ----- | ----- | ----- | 40 | ---- | 5 | 50.80 | 48.26 | 10.92 | 5.84 | 2.79 |
| | 87914-4025 | ----- | ----- | ----- | ----- | 40 | ---- | 5 | 50.80 | 48.26 | 12.25 | 7.00 | 2.96 |
| | 87914-4035 | ----- | ----- | ----- | ----- | 40 | ---- | 5 | 50.80 | 48.26 | 13.38 | 6.09 | 5.00 |
| | 87914-4016 | ----- | ----- | ----- | ----- | 40 | ---- | 6 | 50.80 | 48.26 | 10.92 | 5.84 | 2.79 |
| | 87914-4026 | ----- | ----- | ----- | ----- | 40 | ---- | 6 | 50.80 | 48.26 | 12.25 | 7.00 | 2.96 |
| | 87914-4036 | ----- | ----- | ----- | ----- | 40 | ---- | 6 | 50.80 | 48.26 | 13.38 | 6.09 | 5.00 |
| C | | | | | | | | | | | | | |
| | | | | | | | | | | | | | |
| | | | | | | | | | | | | | |
| | | | | | | | | | | | | | |
| B | | | | | | | | | | | | | |
| | | | | | | | | | | | | | |
| | | | | | | | | | | | | | |

| PG8. +879140108 EC NO: S2010-0695 DRWN:ATSEE 2010/02/11 CHKD:PTLIM 2004/12/08 APPR:MLONG 2010/06/05 D7 | QUALITY SYMBOLS $F_A=0$ $F_G=0$ $F_P=0$ | GENERAL TOLERANCES (UNLESS SPECIFIED) <table border="1"> <tr><th colspan="2">mm</th><th>INCH</th></tr> <tr><td>4 PLACES</td><td>± ---</td><td>± ---</td></tr> <tr><td>3 PLACES</td><td>± ---</td><td>± ---</td></tr> <tr><td>2 PLACES</td><td>± 0.20</td><td>± ---</td></tr> <tr><td>1 PLACE</td><td>± ---</td><td>± ---</td></tr> </table> | mm | | INCH | 4 PLACES | ± --- | ± --- | 3 PLACES | ± --- | ± --- | 2 PLACES | ± 0.20 | ± --- | 1 PLACE | ± --- | ± --- | DIMENSION STYLE MM ONLY | SCALE NTS | DESIGN UNITS METRIC | THIRD ANGLE PROJECTION | DRAWN BY KCHO | DATE 2004/11/05 | TITLE 2.54MM PITCH DUAL ROW HEADER SINGLE WAFER, T/H |
|---|---|---|----------------------------------|---|------------------------------|---------------------------|---------------------------|-------|----------|-------|-------|----------|--------|-------|---------|-------|-------|--|---------------------|-------------------------------|-------------------------------|-------------------------|---------------------------|--|
| | mm | | INCH | | | | | | | | | | | | | | | | | | | | | |
| | 4 PLACES | ± --- | ± --- | | | | | | | | | | | | | | | | | | | | | |
| | 3 PLACES | ± --- | ± --- | | | | | | | | | | | | | | | | | | | | | |
| 2 PLACES | ± 0.20 | ± --- | | | | | | | | | | | | | | | | | | | | | | |
| 1 PLACE | ± --- | ± --- | | | | | | | | | | | | | | | | | | | | | | |
| | | ANGULAR ± 3 ° | CHECKED BY PTLIM | DATE 2004/12/08 | APPROVED BY SCLOW | DATE 2004/12/10 | MOLEX INCORPORATED | | | | | | | | | | | | | | | | | |
| | | DRAFT WHERE APPLICABLE MUST REMAIN WITHIN DIMENSIONS | MATERIAL NO. SEE TABLE | DOCUMENT NO. SD-87914-013 | SHEET NO. 26 OF 46 | | | | | | | | | | | | | | | | | | | |
| | | | SIZE A3 | THIS DRAWING CONTAINS INFORMATION THAT IS PROPRIETARY TO MOLEX INCORPORATED AND SHOULD NOT BE USED WITHOUT WRITTEN PERMISSION | | | | | | | | | | | | | | | | | | | | |

| | 10 | 9 | 8 | 7 | 6 | 5 | 4 | 3 | 2 | 1 | | | |
|---|----------------------------|---|--------------------------------------|--|---|----------|---------------|--------------|-----------|-------|-------|-------|------|
| | PART NO FOR TRAY PACKAGING | PART NO. FOR TUBE WITHOUT CAP PACKAGING | PART NO. FOR TUBE WITH CAP PACKAGING | PART NO. FOR TAPE & REEL WITHOUT CAP PACKAGING | PART NO. FOR TAPE & REEL WITH CAP PACKAGING | CKT SIZE | VOID POSITION | PLATING TYPE | DIMENSION | | | | |
| | | | | | | | | | A | B | F | M | P |
| F | 87914-5011 | ----- | ----- | ----- | ----- | 50 | ---- | 1 | 63.50 | 60.96 | 10.92 | 5.84 | 2.79 |
| | 87914-5021 | ----- | ----- | ----- | ----- | 50 | ---- | 1 | 63.50 | 60.96 | 12.25 | 7.00 | 2.96 |
| | 87914-5012 | ----- | ----- | ----- | ----- | 50 | ---- | 2 | 63.50 | 60.96 | 10.92 | 5.84 | 2.79 |
| | 87914-5022 | ----- | ----- | ----- | ----- | 50 | ---- | 2 | 63.50 | 60.96 | 12.25 | 7.00 | 2.96 |
| | 87914-5013 | ----- | ----- | ----- | ----- | 50 | ---- | 3 | 63.50 | 60.96 | 10.92 | 5.84 | 2.79 |
| | 87914-5023 | ----- | ----- | ----- | ----- | 50 | ---- | 3 | 63.50 | 60.96 | 12.25 | 7.00 | 2.96 |
| E | 87914-5014 | ----- | ----- | ----- | ----- | 50 | ---- | 4 | 63.50 | 60.96 | 10.92 | 5.84 | 2.79 |
| | 87914-5024 | ----- | ----- | ----- | ----- | 50 | ---- | 4 | 63.50 | 60.96 | 12.25 | 7.00 | 2.96 |
| | 87914-5015 | ----- | ----- | ----- | ----- | 50 | ---- | 5 | 63.50 | 60.96 | 10.92 | 5.84 | 2.79 |
| | 87914-5025 | ----- | ----- | ----- | ----- | 50 | ---- | 5 | 63.50 | 60.96 | 12.25 | 7.00 | 2.96 |
| | 87914-5016 | ----- | ----- | ----- | ----- | 50 | ---- | 6 | 63.50 | 60.96 | 10.92 | 5.84 | 2.79 |
| | 87914-5026 | ----- | ----- | ----- | ----- | 50 | ---- | 6 | 63.50 | 60.96 | 12.25 | 7.00 | 2.96 |
| D | 87914-0002 | ----- | ----- | ----- | ----- | 50 | ---- | 8 | 63.50 | 60.96 | 18.54 | 11.58 | 4.47 |
| | | | | | | | | | | | | | |
| | | | | | | | | | | | | | |
| | | | | | | | | | | | | | |
| C | | | | | | | | | | | | | |
| | | | | | | | | | | | | | |
| | | | | | | | | | | | | | |
| B | | | | | | | | | | | | | |
| | | | | | | | | | | | | | |

| | | | | | | | |
|--|-----------------|--|-----------------------------------|---|------------------------|---|-------|
| PG8. +879140108 EC NO: S2010-0695 DRW:ATSEE 2010/02/11 CHKD:PTLIM 2004/12/08 APPR:MLONG 2010/06/05 | QUALITY SYMBOLS | GENERAL TOLERANCES (UNLESS SPECIFIED) | DIMENSION STYLE MM ONLY | SCALE NTS | DESIGN UNITS METRIC | THIRD ANGLE PROJECTION 2.54MM PITCH DUAL ROW HEADER SINGLE WAFER, T/H MOLEX INCORPORATED | |
| | $F_A=0$ | 4 PLACES | mm | DRAWN BY KCHO | DATE 2004/11/05 | | TITLE |
| | $F_G=0$ | 3 PLACES | INCH | CHECKED BY PTLIM | DATE 2004/12/08 | | |
| | $F_P=0$ | 2 PLACES 1 PLACE | ± 0.20 $\pm \quad$ | APPROVED BY SCLOW | DATE 2004/12/10 | | |
| | | ANGULAR $\pm 3^\circ$ | | MATERIAL NO. | DOCUMENT NO. | | |
| | | DRAFT WHERE APPLICABLE MUST REMAIN WITHIN DIMENSIONS | SEE TABLE | | | | |
| | | | SIZE A3 | THIS DRAWING CONTAINS INFORMATION THAT IS PROPRIETARY TO MOLEX INCORPORATED AND SHOULD NOT BE USED WITHOUT WRITTEN PERMISSION | | | |

| PART NO FOR BULK PACKAGING | PART NO. FOR TUBE WITHOUT CAP PACKAGING | PART NO. FOR TUBE WITH CAP PACKAGING | PART NO. FOR TAPE & REEL WITHOUT CAP PACKAGING | PART NO. FOR TAPE & REEL WITH CAP PACKAGING | CKT SIZE | VOID POSITION | PLATING TYPE | DIMENSION | | | | |
|----------------------------|---|--------------------------------------|--|---|----------|---------------|--------------|-----------|------------|-------|-------|-------|
| | | | | | | | | A | B | F | M | P |
| | | | | | | | | F | 87914-5211 | ----- | ----- | ----- |
| | 87914-5221 | ----- | ----- | ----- | 52 | ----- | 1 | 66.04 | 63.50 | 12.25 | 7.00 | 2.96 |
| | 87914-5212 | ----- | ----- | ----- | 52 | ----- | 2 | 66.04 | 63.50 | 10.92 | 5.84 | 2.79 |
| | 87914-5222 | ----- | ----- | ----- | 52 | ----- | 2 | 66.04 | 63.50 | 12.25 | 7.00 | 2.96 |
| | 87914-5213 | ----- | ----- | ----- | 52 | ----- | 3 | 66.04 | 63.50 | 10.92 | 5.84 | 2.79 |
| | 87914-5223 | ----- | ----- | ----- | 52 | ----- | 3 | 66.04 | 63.50 | 12.25 | 7.00 | 2.96 |
| E | 87914-5214 | ----- | ----- | ----- | 52 | ----- | 4 | 66.04 | 63.50 | 10.92 | 5.84 | 2.79 |
| | 87914-5224 | ----- | ----- | ----- | 52 | ----- | 4 | 66.04 | 63.50 | 12.25 | 7.00 | 2.96 |
| | 87914-5215 | ----- | ----- | ----- | 52 | ----- | 5 | 66.04 | 63.50 | 10.92 | 5.84 | 2.79 |
| | 87914-5225 | ----- | ----- | ----- | 52 | ----- | 5 | 66.04 | 63.50 | 12.25 | 7.00 | 2.96 |
| | 87914-5216 | ----- | ----- | ----- | 52 | ----- | 6 | 66.04 | 63.50 | 10.92 | 5.84 | 2.79 |
| | 87914-5226 | ----- | ----- | ----- | 52 | ----- | 6 | 66.04 | 63.50 | 12.25 | 7.00 | 2.96 |
| D | | | | | | | | | | | | |
| | | | | | | | | | | | | |
| | | | | | | | | | | | | |
| | | | | | | | | | | | | |
| C | | | | | | | | | | | | |
| | | | | | | | | | | | | |
| | | | | | | | | | | | | |
| | | | | | | | | | | | | |
| B | | | | | | | | | | | | |
| | | | | | | | | | | | | |
| | | | | | | | | | | | | |

| PG8. +879140108 EC NO: S2010-0695 DRWN:ATSEE 2010/02/11 CHKD:PTLIM 2004/12/08 APPR:MLONG 2010/06/05 | QUALITY SYMBOLS | GENERAL TOLERANCES (UNLESS SPECIFIED) | DIMENSION STYLE MM ONLY | SCALE NTS | DESIGN UNITS METRIC | THIRD ANGLE PROJECTION | | | | | | | | | | | | | | | | | | | | | | | | | | | | | | | | | | | | | | | | | |
|--|-------------------------------|---|---|---------------------|-------------------------------|------------------------|-------|-------|----------|-------|-------|----------|--------|-------|---------|-------|-------|--|----------|------|------|------------|------------|------|-------|------------|-------------|------|-------|------------|---|--|--|-------|--|--|--|--------------------|--|--------------|--------------|-----------|--------------|------|-----------|----|----------|
| | $F_A=0$ $F_C=0$ $F_P=0$ | <table border="1"> <tr><th colspan="2">mm</th><th>INCH</th></tr> <tr><td>4 PLACES</td><td>± ---</td><td>± ---</td></tr> <tr><td>3 PLACES</td><td>± ---</td><td>± ---</td></tr> <tr><td>2 PLACES</td><td>± 0.20</td><td>± ---</td></tr> <tr><td>1 PLACE</td><td>± ---</td><td>± ---</td></tr> </table> | mm | | INCH | 4 PLACES | ± --- | ± --- | 3 PLACES | ± --- | ± --- | 2 PLACES | ± 0.20 | ± --- | 1 PLACE | ± --- | ± --- | <table border="1"> <tr><td>DRAWN BY</td><td>DATE</td></tr> <tr><td>KCHO</td><td>2004/11/05</td></tr> <tr><td>CHECKED BY</td><td>DATE</td></tr> <tr><td>PTLIM</td><td>2004/12/08</td></tr> <tr><td>APPROVED BY</td><td>DATE</td></tr> <tr><td>SCLOW</td><td>2004/12/10</td></tr> </table> | DRAWN BY | DATE | KCHO | 2004/11/05 | CHECKED BY | DATE | PTLIM | 2004/12/08 | APPROVED BY | DATE | SCLOW | 2004/12/10 | <table border="1"> <tr><td colspan="2">TITLE</td></tr> <tr><td colspan="2" style="text-align: center;">2.54MM PITCH DUAL ROW HEADER SINGLE WAFER, T/H</td></tr> <tr><td colspan="2" style="text-align: center;">MOLEX INCORPORATED</td></tr> <tr><td>MATERIAL NO.</td><td>DOCUMENT NO.</td></tr> <tr><td>SEE TABLE</td><td>SD-87914-013</td></tr> <tr><td>SIZE</td><td>SHEET NO.</td></tr> <tr><td>A3</td><td>32 OF 46</td></tr> </table> | | | TITLE | | 2.54MM PITCH DUAL ROW HEADER SINGLE WAFER, T/H | | MOLEX INCORPORATED | | MATERIAL NO. | DOCUMENT NO. | SEE TABLE | SD-87914-013 | SIZE | SHEET NO. | A3 | 32 OF 46 |
| | mm | | INCH | | | | | | | | | | | | | | | | | | | | | | | | | | | | | | | | | | | | | | | | | | | | |
| | 4 PLACES | ± --- | ± --- | | | | | | | | | | | | | | | | | | | | | | | | | | | | | | | | | | | | | | | | | | | | |
| | 3 PLACES | ± --- | ± --- | | | | | | | | | | | | | | | | | | | | | | | | | | | | | | | | | | | | | | | | | | | | |
| 2 PLACES | ± 0.20 | ± --- | | | | | | | | | | | | | | | | | | | | | | | | | | | | | | | | | | | | | | | | | | | | | |
| 1 PLACE | ± --- | ± --- | | | | | | | | | | | | | | | | | | | | | | | | | | | | | | | | | | | | | | | | | | | | | |
| DRAWN BY | DATE | | | | | | | | | | | | | | | | | | | | | | | | | | | | | | | | | | | | | | | | | | | | | | |
| KCHO | 2004/11/05 | | | | | | | | | | | | | | | | | | | | | | | | | | | | | | | | | | | | | | | | | | | | | | |
| CHECKED BY | DATE | | | | | | | | | | | | | | | | | | | | | | | | | | | | | | | | | | | | | | | | | | | | | | |
| PTLIM | 2004/12/08 | | | | | | | | | | | | | | | | | | | | | | | | | | | | | | | | | | | | | | | | | | | | | | |
| APPROVED BY | DATE | | | | | | | | | | | | | | | | | | | | | | | | | | | | | | | | | | | | | | | | | | | | | | |
| SCLOW | 2004/12/10 | | | | | | | | | | | | | | | | | | | | | | | | | | | | | | | | | | | | | | | | | | | | | | |
| TITLE | | | | | | | | | | | | | | | | | | | | | | | | | | | | | | | | | | | | | | | | | | | | | | | |
| 2.54MM PITCH DUAL ROW HEADER SINGLE WAFER, T/H | | | | | | | | | | | | | | | | | | | | | | | | | | | | | | | | | | | | | | | | | | | | | | | |
| MOLEX INCORPORATED | | | | | | | | | | | | | | | | | | | | | | | | | | | | | | | | | | | | | | | | | | | | | | | |
| MATERIAL NO. | DOCUMENT NO. | | | | | | | | | | | | | | | | | | | | | | | | | | | | | | | | | | | | | | | | | | | | | | |
| SEE TABLE | SD-87914-013 | | | | | | | | | | | | | | | | | | | | | | | | | | | | | | | | | | | | | | | | | | | | | | |
| SIZE | SHEET NO. | | | | | | | | | | | | | | | | | | | | | | | | | | | | | | | | | | | | | | | | | | | | | | |
| A3 | 32 OF 46 | | | | | | | | | | | | | | | | | | | | | | | | | | | | | | | | | | | | | | | | | | | | | | |
| ANGULAR ± 3 ° | | DRAFT WHERE APPLICABLE MUST REMAIN WITHIN DIMENSIONS | THIS DRAWING CONTAINS INFORMATION THAT IS PROPRIETARY TO MOLEX INCORPORATED AND SHOULD NOT BE USED WITHOUT WRITTEN PERMISSION | | | | | | | | | | | | | | | | | | | | | | | | | | | | | | | | | | | | | | | | | | | | |
| | | | | | | | | | | | | | | | | | | | | | | | | | | | | | | | | | | | | | | | | | | | | | | | |
| D7 | REV | | | | | | | | | | | | | | | | | | | | | | | | | | | | | | | | | | | | | | | | | | | | | | |

| | 10 | 9 | 8 | 7 | 6 | 5 | 4 | 3 | 2 | 1 | | | |
|---|----------------------------|---|--------------------------------------|--|---|----------|---------------|--------------|-----------|-------|-------|------|------|
| | PART NO FOR BULK PACKAGING | PART NO. FOR TUBE WITHOUT CAP PACKAGING | PART NO. FOR TUBE WITH CAP PACKAGING | PART NO. FOR TAPE & REEL WITHOUT CAP PACKAGING | PART NO. FOR TAPE & REEL WITH CAP PACKAGING | CKT SIZE | VOID POSITION | PLATING TYPE | DIMENSION | | | | |
| | A | B | F | M | P | | | | | | | | |
| F | 87914-5411 | ----- | ----- | ----- | ----- | 54 | ---- | 1 | 68.58 | 66.04 | 10.92 | 5.84 | 2.79 |
| | 87914-5421 | ----- | ----- | ----- | ----- | 54 | ---- | 1 | 68.58 | 66.04 | 12.25 | 7.00 | 2.96 |
| | 87914-5412 | ----- | ----- | ----- | ----- | 54 | ---- | 2 | 68.58 | 66.04 | 10.92 | 5.84 | 2.79 |
| | 87914-5422 | ----- | ----- | ----- | ----- | 54 | ---- | 2 | 68.58 | 66.04 | 12.25 | 7.00 | 2.96 |
| | 87914-5413 | ----- | ----- | ----- | ----- | 54 | ---- | 3 | 68.58 | 66.04 | 10.92 | 5.84 | 2.79 |
| | 87914-5423 | ----- | ----- | ----- | ----- | 54 | ---- | 3 | 68.58 | 66.04 | 12.25 | 7.00 | 2.96 |
| E | 87914-5414 | ----- | ----- | ----- | ----- | 54 | ---- | 4 | 68.58 | 66.04 | 10.92 | 5.84 | 2.79 |
| | 87914-5424 | ----- | ----- | ----- | ----- | 54 | ---- | 4 | 68.58 | 66.04 | 12.25 | 7.00 | 2.96 |
| | 87914-5415 | ----- | ----- | ----- | ----- | 54 | ---- | 5 | 68.58 | 66.04 | 10.92 | 5.84 | 2.79 |
| | 87914-5425 | ----- | ----- | ----- | ----- | 54 | ---- | 5 | 68.58 | 66.04 | 12.25 | 7.00 | 2.96 |
| | 87914-5416 | ----- | ----- | ----- | ----- | 54 | ---- | 6 | 68.58 | 66.04 | 10.92 | 5.84 | 2.79 |
| | 87914-5426 | ----- | ----- | ----- | ----- | 54 | ---- | 6 | 68.58 | 66.04 | 12.25 | 7.00 | 2.96 |
| D | | | | | | | | | | | | | |
| | | | | | | | | | | | | | |
| | | | | | | | | | | | | | |
| | | | | | | | | | | | | | |
| | | | | | | | | | | | | | |
| C | | | | | | | | | | | | | |
| | | | | | | | | | | | | | |
| | | | | | | | | | | | | | |
| | | | | | | | | | | | | | |
| | | | | | | | | | | | | | |
| B | | | | | | | | | | | | | |
| | | | | | | | | | | | | | |

| PG8. +879140108 EC NO: S2010-0695 DRWN:ATSEE 2010/02/11 CHKD:PTLIM 2004/12/08 APPR:MLONG 2010/06/05 D7 REV | QUALITY SYMBOLS | GENERAL TOLERANCES (UNLESS SPECIFIED) <table border="1"> <tr><th></th><th>mm</th><th>INCH</th></tr> <tr><td>4 PLACES</td><td>± ---</td><td>± ---</td></tr> <tr><td>3 PLACES</td><td>± ---</td><td>± ---</td></tr> <tr><td>2 PLACES</td><td>± 0.20</td><td>± ---</td></tr> <tr><td>1 PLACE</td><td>± ---</td><td>± ---</td></tr> </table> | | mm | INCH | 4 PLACES | ± --- | ± --- | 3 PLACES | ± --- | ± --- | 2 PLACES | ± 0.20 | ± --- | 1 PLACE | ± --- | ± --- | DIMENSION STYLE MM ONLY | SCALE NTS | DESIGN UNITS METRIC | THIRD ANGLE PROJECTION |
|---|----------------------|---|--------------------|--|------|----------|-------|-------|----------|-------|-------|----------|--------|-------|---------|-------|-------|-----------------------------------|--------------|------------------------|------------------------|
| | | | mm | INCH | | | | | | | | | | | | | | | | | |
| | 4 PLACES | | ± --- | ± --- | | | | | | | | | | | | | | | | | |
| | 3 PLACES | | ± --- | ± --- | | | | | | | | | | | | | | | | | |
| 2 PLACES | ± 0.20 | ± --- | | | | | | | | | | | | | | | | | | | |
| 1 PLACE | ± --- | ± --- | | | | | | | | | | | | | | | | | | | |
| $F_A=0$ | 4 PLACES ± --- ± --- | DRAWN BY KCHO | DATE 2004/11/05 | TITLE 2.54MM PITCH DUAL ROW HEADER SINGLE WAFER, T/H | | | | | | | | | | | | | | | | | |
| $F_G=0$ | 3 PLACES ± --- ± --- | CHECKED BY PTLIM | DATE 2004/12/08 |  MOLEX INCORPORATED MATERIAL NO. SEE TABLE DOCUMENT NO. SD-87914-013 SHEET NO. 33 OF 46 | | | | | | | | | | | | | | | | | |
| $F_P=0$ | ANGULAR ± 3 ° | APPROVED BY SCLOW | DATE 2004/12/10 | | | | | | | | | | | | | | | | | | |

| | 10 | 9 | 8 | 7 | 6 | 5 | 4 | 3 | 2 | 1 | | | |
|---|----------------------------|---|--------------------------------------|--|---|----------|---------------|--------------|-----------|-------|-------|------|------|
| | PART NO FOR BULK PACKAGING | PART NO. FOR TUBE WITHOUT CAP PACKAGING | PART NO. FOR TUBE WITH CAP PACKAGING | PART NO. FOR TAPE & REEL WITHOUT CAP PACKAGING | PART NO. FOR TAPE & REEL WITH CAP PACKAGING | CKT SIZE | VOID POSITION | PLATING TYPE | DIMENSION | | | | |
| | | | | | | | | | A | B | F | M | P |
| F | 87914-5611 | ----- | ----- | ----- | ----- | 56 | ---- | 1 | 71.12 | 68.58 | 10.92 | 5.84 | 2.79 |
| | 87914-5621 | ----- | ----- | ----- | ----- | 56 | ---- | 1 | 71.12 | 68.58 | 12.25 | 7.00 | 2.96 |
| | 87914-5612 | ----- | ----- | ----- | ----- | 56 | ---- | 2 | 71.12 | 68.58 | 10.92 | 5.84 | 2.79 |
| | 87914-5622 | ----- | ----- | ----- | ----- | 56 | ---- | 2 | 71.12 | 68.58 | 12.25 | 7.00 | 2.96 |
| | 87914-5613 | ----- | ----- | ----- | ----- | 56 | ---- | 3 | 71.12 | 68.58 | 10.92 | 5.84 | 2.79 |
| | 87914-5623 | ----- | ----- | ----- | ----- | 56 | ---- | 3 | 71.12 | 68.58 | 12.25 | 7.00 | 2.96 |
| E | 87914-5614 | ----- | ----- | ----- | ----- | 56 | ---- | 4 | 71.12 | 68.58 | 10.92 | 5.84 | 2.79 |
| | 87914-5624 | ----- | ----- | ----- | ----- | 56 | ---- | 4 | 71.12 | 68.58 | 12.25 | 7.00 | 2.96 |
| | 87914-5615 | ----- | ----- | ----- | ----- | 56 | ---- | 5 | 71.12 | 68.58 | 10.92 | 5.84 | 2.79 |
| | 87914-5625 | ----- | ----- | ----- | ----- | 56 | ---- | 5 | 71.12 | 68.58 | 12.25 | 7.00 | 2.96 |
| | 87914-5616 | ----- | ----- | ----- | ----- | 56 | ---- | 6 | 71.12 | 68.58 | 10.92 | 5.84 | 2.79 |
| | 87914-5626 | ----- | ----- | ----- | ----- | 56 | ---- | 6 | 71.12 | 68.58 | 12.25 | 7.00 | 2.96 |
| D | | | | | | | | | | | | | |
| | | | | | | | | | | | | | |
| | | | | | | | | | | | | | |
| | | | | | | | | | | | | | |
| | | | | | | | | | | | | | |
| | | | | | | | | | | | | | |
| C | | | | | | | | | | | | | |
| | | | | | | | | | | | | | |
| | | | | | | | | | | | | | |
| | | | | | | | | | | | | | |
| | | | | | | | | | | | | | |
| | | | | | | | | | | | | | |
| | | | | | | | | | | | | | |
| | | | | | | | | | | | | | |
| B | | | | | | | | | | | | | |
| | | | | | | | | | | | | | |
| | | | | | | | | | | | | | |
| | | | | | | | | | | | | | |
| | | | | | | | | | | | | | |

| PG8. +879140108 EC NO: S2010-0695 DRWN:ATSEE 2010/02/11 CHKD:PTLIM 2004/12/08 APPR:MLONG 2010/06/05 D7 | QUALITY SYMBOLS | GENERAL TOLERANCES (UNLESS SPECIFIED) | DIMENSION STYLE | SCALE | DESIGN UNITS | THIRD ANGLE PROJECTION | | | | | | | | | | | | | | | |
|---|--|---|---|--|--------------|------------------------|-------|-------|----------|-------|-------|----------|--------|-------|---------|-------|-------|---------|-----|--------|--|
| | $F_A=0$ $F_G=0$ $F_P=0$ | <table border="1"> <tr><th colspan="2">mm</th><th>INCH</th></tr> <tr><td>4 PLACES</td><td>± ---</td><td>± ---</td></tr> <tr><td>3 PLACES</td><td>± ---</td><td>± ---</td></tr> <tr><td>2 PLACES</td><td>± 0.20</td><td>± ---</td></tr> <tr><td>1 PLACE</td><td>± ---</td><td>± ---</td></tr> </table> | mm | | INCH | 4 PLACES | ± --- | ± --- | 3 PLACES | ± --- | ± --- | 2 PLACES | ± 0.20 | ± --- | 1 PLACE | ± --- | ± --- | MM ONLY | NTS | METRIC | |
| | mm | | INCH | | | | | | | | | | | | | | | | | | |
| | 4 PLACES | ± --- | ± --- | | | | | | | | | | | | | | | | | | |
| | 3 PLACES | ± --- | ± --- | | | | | | | | | | | | | | | | | | |
| | 2 PLACES | ± 0.20 | ± --- | | | | | | | | | | | | | | | | | | |
| 1 PLACE | ± --- | ± --- | | | | | | | | | | | | | | | | | | | |
| DESCRIPTION | ANGULAR ± 3 ° | DRAWN BY | DATE | TITLE | | | | | | | | | | | | | | | | | |
| | DRAFT WHERE APPLICABLE MUST REMAIN WITHIN DIMENSIONS | KCHO | 2004/11/05 | 2.54MM PITCH DUAL ROW HEADER SINGLE WAFER, T/H | | | | | | | | | | | | | | | | | |
| | | PTLIM | 2004/12/08 | MOLEX INCORPORATED | | | | | | | | | | | | | | | | | |
| | | APPROVED BY | DATE | MATERIAL NO. | DOCUMENT NO. | SHEET NO. | | | | | | | | | | | | | | | |
| | | SCLOW | 2004/12/10 | SEE TABLE | SD-87914-013 | 34 OF 46 | | | | | | | | | | | | | | | |
| | | SIZE | THIS DRAWING CONTAINS INFORMATION THAT IS PROPRIETARY TO MOLEX INCORPORATED AND SHOULD NOT BE USED WITHOUT WRITTEN PERMISSION | | | | | | | | | | | | | | | | | | |
| | | A3 | | | | | | | | | | | | | | | | | | | |

| PART NO FOR BULK PACKAGING | PART NO. FOR TUBE WITHOUT CAP PACKAGING | PART NO. FOR TUBE WITH CAP PACKAGING | PART NO. FOR TAPE & REEL WITHOUT CAP PACKAGING | PART NO. FOR TAPE & REEL WITH CAP PACKAGING | CKT SIZE | VOID POSITION | PLATING TYPE | DIMENSION | | | | |
|----------------------------|---|--------------------------------------|--|---|----------|---------------|--------------|-----------|-------|-------|------|------|
| | | | | | | | | A | B | F | M | P |
| 87914-5811 | ----- | ----- | ----- | ----- | 58 | ---- | 1 | 73.66 | 71.12 | 10.92 | 5.84 | 2.79 |
| 87914-5821 | ----- | ----- | ----- | ----- | 58 | ---- | 1 | 73.66 | 71.12 | 12.25 | 7.00 | 2.96 |
| 87914-5812 | ----- | ----- | ----- | ----- | 58 | ---- | 2 | 73.66 | 71.12 | 10.92 | 5.84 | 2.79 |
| 87914-5822 | ----- | ----- | ----- | ----- | 58 | ---- | 2 | 73.66 | 71.12 | 12.25 | 7.00 | 2.96 |
| 87914-5813 | ----- | ----- | ----- | ----- | 58 | ---- | 3 | 73.66 | 71.12 | 10.92 | 5.84 | 2.79 |
| 87914-5823 | ----- | ----- | ----- | ----- | 58 | ---- | 3 | 73.66 | 71.12 | 12.25 | 7.00 | 2.96 |
| 87914-5814 | ----- | ----- | ----- | ----- | 58 | ---- | 4 | 73.66 | 71.12 | 10.92 | 5.84 | 2.79 |
| 87914-5824 | ----- | ----- | ----- | ----- | 58 | ---- | 4 | 73.66 | 71.12 | 12.25 | 7.00 | 2.96 |
| 87914-5815 | ----- | ----- | ----- | ----- | 58 | ---- | 5 | 73.66 | 71.12 | 10.92 | 5.84 | 2.79 |
| 87914-5825 | ----- | ----- | ----- | ----- | 58 | ---- | 5 | 73.66 | 71.12 | 12.25 | 7.00 | 2.96 |
| 87914-5816 | ----- | ----- | ----- | ----- | 58 | ---- | 6 | 73.66 | 71.12 | 10.92 | 5.84 | 2.79 |
| 87914-5826 | ----- | ----- | ----- | ----- | 58 | ---- | 6 | 73.66 | 71.12 | 12.25 | 7.00 | 2.96 |

| | | | | | | | | |
|---|--|--|-----------------|-------------|---|---|------------------------|-----------|
| PG8. +879140108 EC NO: S2010-0695 DRWN:ATSEE 2010/02/11 CHKD:PTLIM 2004/12/08 APPR:MLONG 2010/06/05 | QUALITY SYMBOLS | GENERAL TOLERANCES (UNLESS SPECIFIED) | DIMENSION STYLE | | SCALE | DESIGN UNITS | THIRD ANGLE PROJECTION | |
| | $\nabla_A = 0$ $\nabla_C = 0$ $\nabla_P = 0$ | | MM ONLY | NTS | METRIC | | | |
| DESCRIPTION REV D7 | 4 PLACES | mm | INCH | DRAWN BY | DATE | TITLE 2.54MM PITCH DUAL ROW HEADER SINGLE WAFER, T/H | | |
| | 3 PLACES | ± --- | ± --- | KCHO | 2004/11/05 | | | |
| | 2 PLACES | ± 0.20 | ± --- | CHECKED BY | DATE | MOLEX INCORPORATED | | |
| 1 PLACE | ± --- | ± --- | PTLIM | 2004/12/08 | | | | |
| ANGULAR ± 3 ° | | DRAFT WHERE APPLICABLE MUST REMAIN WITHIN DIMENSIONS | | APPROVED BY | DATE | MATERIAL NO. | DOCUMENT NO. | SHEET NO. |
| | | | | SCLOW | 2004/12/10 | SEE TABLE | SD-87914-013 | 35 OF 46 |
| | | | | SIZE | THIS DRAWING CONTAINS INFORMATION THAT IS PROPRIETARY TO MOLEX INCORPORATED AND SHOULD NOT BE USED WITHOUT WRITTEN PERMISSION | | | |
| | | | | A3 | | | | |

| | 10 | | 9 | | 8 | | 7 | | 6 | | 5 | | 4 | | 3 | | 2 | | 1 | |
|---|----------------------------|---|--------------------------------------|--|---|----------|---------------|--------------|-----------|-------|-------|------|------|--|---|--|---|--|---|--|
| | PART NO FOR BULK PACKAGING | PART NO. FOR TUBE WITHOUT CAP PACKAGING | PART NO. FOR TUBE WITH CAP PACKAGING | PART NO. FOR TAPE & REEL WITHOUT CAP PACKAGING | PART NO. FOR TAPE & REEL WITH CAP PACKAGING | CKT SIZE | VOID POSITION | PLATING TYPE | DIMENSION | | | | | | | | | | | |
| | | | | | | | | | A | B | F | M | P | | | | | | | |
| F | 87914-6011 | ----- | ----- | ----- | ----- | 60 | ---- | 1 | 76.20 | 73.66 | 10.92 | 5.84 | 2.79 | | | | | | | |
| | 87914-6021 | ----- | ----- | ----- | ----- | 60 | ---- | 1 | 76.20 | 73.66 | 12.25 | 7.00 | 2.96 | | | | | | | |
| | 87914-6012 | ----- | ----- | ----- | ----- | 60 | ---- | 2 | 76.20 | 73.66 | 10.92 | 5.84 | 2.79 | | | | | | | |
| | 87914-6022 | ----- | ----- | ----- | ----- | 60 | ---- | 2 | 76.20 | 73.66 | 12.25 | 7.00 | 2.96 | | | | | | | |
| | 87914-6013 | ----- | ----- | ----- | ----- | 60 | ---- | 3 | 76.20 | 73.66 | 10.92 | 5.84 | 2.79 | | | | | | | |
| | 87914-6023 | ----- | ----- | ----- | ----- | 60 | ---- | 3 | 76.20 | 73.66 | 12.25 | 7.00 | 2.96 | | | | | | | |
| E | 87914-6014 | ----- | ----- | ----- | ----- | 60 | ---- | 4 | 76.20 | 73.66 | 10.92 | 5.84 | 2.79 | | | | | | | |
| | 87914-6024 | ----- | ----- | ----- | ----- | 60 | ---- | 4 | 76.20 | 73.66 | 12.25 | 7.00 | 2.96 | | | | | | | |
| | 87914-6015 | ----- | ----- | ----- | ----- | 60 | ---- | 5 | 76.20 | 73.66 | 10.92 | 5.84 | 2.79 | | | | | | | |
| | 87914-6025 | ----- | ----- | ----- | ----- | 60 | ---- | 5 | 76.20 | 73.66 | 12.25 | 7.00 | 2.96 | | | | | | | |
| | 87914-6016 | ----- | ----- | ----- | ----- | 60 | ---- | 6 | 76.20 | 73.66 | 10.92 | 5.84 | 2.79 | | | | | | | |
| | 87914-6026 | ----- | ----- | ----- | ----- | 60 | ---- | 6 | 76.20 | 73.66 | 12.25 | 7.00 | 2.96 | | | | | | | |
| D | | | | | | | | | | | | | | | | | | | | |
| | | | | | | | | | | | | | | | | | | | | |
| | | | | | | | | | | | | | | | | | | | | |
| | | | | | | | | | | | | | | | | | | | | |
| | | | | | | | | | | | | | | | | | | | | |
| | | | | | | | | | | | | | | | | | | | | |
| | | | | | | | | | | | | | | | | | | | | |
| | | | | | | | | | | | | | | | | | | | | |
| | | | | | | | | | | | | | | | | | | | | |
| | | | | | | | | | | | | | | | | | | | | |
| | | | | | | | | | | | | | | | | | | | | |
| | | | | | | | | | | | | | | | | | | | | |
| | | | | | | | | | | | | | | | | | | | | |
| | | | | | | | | | | | | | | | | | | | | |
| | | | | | | | | | | | | | | | | | | | | |
| | | | | | | | | | | | | | | | | | | | | |
| | | | | | | | | | | | | | | | | | | | | |
| | | | | | | | | | | | | | | | | | | | | |
| | | | | | | | | | | | | | | | | | | | | |
| | | | | | | | | | | | | | | | | | | | | |
| | | | | | | | | | | | | | | | | | | | | |
| | | | | | | | | | | | | | | | | | | | | |
| | | | | | | | | | | | | | | | | | | | | |
| | | | | | | | | | | | | | | | | | | | | |
| | | | | | | | | | | | | | | | | | | | | |
| | | | | | | | | | | | | | | | | | | | | |
| | | | | | | | | | | | | | | | | | | | | |
| | | | | | | | | | | | | | | | | | | | | |
| | | | | | | | | | | | | | | | | | | | | |
| | | | | | | | | | | | | | | | | | | | | |
| | | | | | | | | | | | | | | | | | | | | |
| | | | | | | | | | | | | | | | | | | | | |
| | | | | | | | | | | | | | | | | | | | | |
| | | | | | | | | | | | | | | | | | | | | |
| | | | | | | | | | | | | | | | | | | | | |

| PG8. +879140108 EC NO: S2010-0695 DRWN:ATSEE 2010/02/11 CHKD:PTLIM 2004/12/08 APPR:MLONG 2010/06/05 | QUALITY SYMBOLS $\nabla_A = 0$ $\nabla_C = 0$ $\nabla_P = 0$ | GENERAL TOLERANCES (UNLESS SPECIFIED) <table border="1"> <tr> <th></th> <th>mm</th> <th>INCH</th> </tr> <tr> <td>4 PLACES</td> <td>± ---</td> <td>± ---</td> </tr> <tr> <td>3 PLACES</td> <td>± ---</td> <td>± ---</td> </tr> <tr> <td>2 PLACES</td> <td>± 0.20</td> <td>± ---</td> </tr> <tr> <td>1 PLACE</td> <td>± ---</td> <td>± ---</td> </tr> </table> | | mm | INCH | 4 PLACES | ± --- | ± --- | 3 PLACES | ± --- | ± --- | 2 PLACES | ± 0.20 | ± --- | 1 PLACE | ± --- | ± --- | DIMENSION STYLE MM ONLY | SCALE NTS | DESIGN UNITS METRIC | THIRD ANGLE PROJECTION | DRAWN BY: KCHO DATE: 2004/11/05 | TITLE 2.54MM PITCH DUAL ROW HEADER SINGLE WAFER, T/H |
|--|---|---|---------------------------|---|------------------------------|----------|-------|-------|----------|-------|-------|----------|--------|-------|---------|-------|-------|-----------------------------------|---------------------|-------------------------------|------------------------|------------------------------------|--|
| | | | | mm | INCH | | | | | | | | | | | | | | | | | | |
| | | | 4 PLACES | ± --- | ± --- | | | | | | | | | | | | | | | | | | |
| | | | 3 PLACES | ± --- | ± --- | | | | | | | | | | | | | | | | | | |
| 2 PLACES | ± 0.20 | ± --- | | | | | | | | | | | | | | | | | | | | | |
| 1 PLACE | ± --- | ± --- | | | | | | | | | | | | | | | | | | | | | |
| CHECKED BY: PTLIM DATE: 2004/12/08 | | | | | | | | | | | | | | | | | | | | | | | |
| APPROVED BY: SCLOW DATE: 2004/12/10 | | | | | | | | | | | | | | | | | | | | | | | |
| MATERIAL NO. | | | | | | | | | | | | | | | | | | | | | | | |
| D7 | DRAFT WHERE APPLICABLE MUST REMAIN WITHIN DIMENSIONS | SEE TABLE | MOLEX INCORPORATED | SD-87914-013 | SHEET NO. 36 OF 46 | | | | | | | | | | | | | | | | | | |
| | | | SIZE A3 | THIS DRAWING CONTAINS INFORMATION THAT IS PROPRIETARY TO MOLEX INCORPORATED AND SHOULD NOT BE USED WITHOUT WRITTEN PERMISSION | | | | | | | | | | | | | | | | | | | |

| PART NO FOR BULK PACKAGING | PART NO. FOR TUBE WITHOUT CAP PACKAGING | PART NO. FOR TUBE WITH CAP PACKAGING | PART NO. FOR TAPE & REEL WITHOUT CAP PACKAGING | PART NO. FOR TAPE & REEL WITH CAP PACKAGING | CKT SIZE | VOID POSITION | PLATING TYPE | DIMENSION | | | | |
|----------------------------|---|--------------------------------------|--|---|----------|---------------|--------------|-----------|-------|-------|------|------|
| | | | | | | | | A | B | F | M | P |
| 87914-6211 | ----- | ----- | ----- | ----- | 62 | ---- | 1 | 78.74 | 76.20 | 10.92 | 5.84 | 2.79 |
| 87914-6221 | ----- | ----- | ----- | ----- | 62 | ---- | 1 | 78.74 | 76.20 | 12.25 | 7.00 | 2.96 |
| 87914-6212 | ----- | ----- | ----- | ----- | 62 | ---- | 2 | 78.74 | 76.20 | 10.92 | 5.84 | 2.79 |
| 87914-6222 | ----- | ----- | ----- | ----- | 62 | ---- | 2 | 78.74 | 76.20 | 12.25 | 7.00 | 2.96 |
| 87914-6213 | ----- | ----- | ----- | ----- | 62 | ---- | 3 | 78.74 | 76.20 | 10.92 | 5.84 | 2.79 |
| 87914-6223 | ----- | ----- | ----- | ----- | 62 | ---- | 3 | 78.74 | 76.20 | 12.25 | 7.00 | 2.96 |
| 87914-6214 | ----- | ----- | ----- | ----- | 62 | ---- | 4 | 78.74 | 76.20 | 10.92 | 5.84 | 2.79 |
| 87914-6224 | ----- | ----- | ----- | ----- | 62 | ---- | 4 | 78.74 | 76.20 | 12.25 | 7.00 | 2.96 |
| 87914-6215 | ----- | ----- | ----- | ----- | 62 | ---- | 5 | 78.74 | 76.20 | 10.92 | 5.84 | 2.79 |
| 87914-6225 | ----- | ----- | ----- | ----- | 62 | ---- | 5 | 78.74 | 76.20 | 12.25 | 7.00 | 2.96 |
| 87914-6216 | ----- | ----- | ----- | ----- | 62 | ---- | 6 | 78.74 | 76.20 | 10.92 | 5.84 | 2.79 |
| 87914-6226 | ----- | ----- | ----- | ----- | 62 | ---- | 6 | 78.74 | 76.20 | 12.25 | 7.00 | 2.96 |

| PG8, +879140108 EC NO: S2010-0695 DRWN:ATSEE 2010/02/11 CHKD:PTLIM 2004/12/08 APPR:MLONG 2010/06/05 D7 REV | QUALITY SYMBOLS $F_A=0$ $F_G=0$ $F_P=0$ | GENERAL TOLERANCES (UNLESS SPECIFIED) <table border="1"> <thead> <tr> <th></th> <th>mm</th> <th>INCH</th> </tr> </thead> <tbody> <tr> <td>4 PLACES</td> <td>± ---</td> <td>± ---</td> </tr> <tr> <td>3 PLACES</td> <td>± ---</td> <td>± ---</td> </tr> <tr> <td>2 PLACES</td> <td>± 0.20</td> <td>± ---</td> </tr> <tr> <td>1 PLACE</td> <td>± ---</td> <td>± ---</td> </tr> </tbody> </table> | | mm | INCH | 4 PLACES | ± --- | ± --- | 3 PLACES | ± --- | ± --- | 2 PLACES | ± 0.20 | ± --- | 1 PLACE | ± --- | ± --- | DIMENSION STYLE MM ONLY DRAWN BY: KCHO CHECKED BY: PTLIM APPROVED BY: SCLOW DATE: 2004/11/05 DATE: 2004/12/08 DATE: 2004/12/10 | SCALE NTS | DESIGN UNITS METRIC | THIRD ANGLE PROJECTION | 2.54MM PITCH DUAL ROW HEADER SINGLE WAFER, T/H |
|--|--|---|-------|----------------------------------|---------------------------|---|-----------------------|-------|----------|-------|-------|----------|--------|-------|---------|-------|-------|--|---------------------|-------------------------------|------------------------|---|
| | | mm | INCH | | | | | | | | | | | | | | | | | | | |
| | 4 PLACES | ± --- | ± --- | | | | | | | | | | | | | | | | | | | |
| | 3 PLACES | ± --- | ± --- | | | | | | | | | | | | | | | | | | | |
| 2 PLACES | ± 0.20 | ± --- | | | | | | | | | | | | | | | | | | | | |
| 1 PLACE | ± --- | ± --- | | | | | | | | | | | | | | | | | | | | |
| DRAFT WHERE APPLICABLE MUST REMAIN WITHIN DIMENSIONS | | | | MATERIAL NO. SEE TABLE | MOLEX INCORPORATED | | SHEET NO. 37 OF 46 | | | | | | | | | | | | | | | |
| | | | | SIZE A3 | | THIS DRAWING CONTAINS INFORMATION THAT IS PROPRIETARY TO MOLEX INCORPORATED AND SHOULD NOT BE USED WITHOUT WRITTEN PERMISSION | | | | | | | | | | | | | | | | |
| | | | | DOCUMENT NO. SD-87914-013 | | | | | | | | | | | | | | | | | | |

| | 10 | 9 | 8 | 7 | 6 | 5 | 4 | 3 | 2 | 1 | | | |
|---|----------------------------|---|--------------------------------------|--|---|----------|---------------|--------------|-----------|-------|-------|------|------|
| | PART NO FOR BULK PACKAGING | PART NO. FOR TUBE WITHOUT CAP PACKAGING | PART NO. FOR TUBE WITH CAP PACKAGING | PART NO. FOR TAPE & REEL WITHOUT CAP PACKAGING | PART NO. FOR TAPE & REEL WITH CAP PACKAGING | CKT SIZE | VOID POSITION | PLATING TYPE | DIMENSION | | | | |
| | | | | | | | | A | B | F | M | P | |
| F | 87914-6411 | ----- | ----- | ----- | ----- | 64 | ---- | 1 | 81.28 | 78.74 | 10.92 | 5.84 | 2.79 |
| | 87914-6421 | ----- | ----- | ----- | ----- | 64 | ---- | 1 | 81.28 | 78.74 | 12.25 | 7.00 | 2.96 |
| | 87914-6412 | ----- | ----- | ----- | ----- | 64 | ---- | 2 | 81.28 | 78.74 | 10.92 | 5.84 | 2.79 |
| | 87914-6422 | ----- | ----- | ----- | ----- | 64 | ---- | 2 | 81.28 | 78.74 | 12.25 | 7.00 | 2.96 |
| | 87914-6413 | ----- | ----- | ----- | ----- | 64 | ---- | 3 | 81.28 | 78.74 | 10.92 | 5.84 | 2.79 |
| | 87914-6423 | ----- | ----- | ----- | ----- | 64 | ---- | 3 | 81.28 | 78.74 | 12.25 | 7.00 | 2.96 |
| E | 87914-6414 | ----- | ----- | ----- | ----- | 64 | ---- | 4 | 81.28 | 78.74 | 10.92 | 5.84 | 2.79 |
| | 87914-6424 | ----- | ----- | ----- | ----- | 64 | ---- | 4 | 81.28 | 78.74 | 12.25 | 7.00 | 2.96 |
| | 87914-6415 | ----- | ----- | ----- | ----- | 64 | ---- | 5 | 81.28 | 78.74 | 10.92 | 5.84 | 2.79 |
| | 87914-6425 | ----- | ----- | ----- | ----- | 64 | ---- | 5 | 81.28 | 78.74 | 12.25 | 7.00 | 2.96 |
| | 87914-6416 | ----- | ----- | ----- | ----- | 64 | ---- | 6 | 81.28 | 78.74 | 10.92 | 5.84 | 2.79 |
| | 87914-6426 | ----- | ----- | ----- | ----- | 64 | ---- | 6 | 81.28 | 78.74 | 12.25 | 7.00 | 2.96 |
| D | | | | | | | | | | | | | |
| | | | | | | | | | | | | | |
| | | | | | | | | | | | | | |
| | | | | | | | | | | | | | |
| | | | | | | | | | | | | | |
| C | | | | | | | | | | | | | |
| | | | | | | | | | | | | | |
| | | | | | | | | | | | | | |
| | | | | | | | | | | | | | |
| | | | | | | | | | | | | | |
| B | | | | | | | | | | | | | |
| | | | | | | | | | | | | | |

| | | | | | | |
|---|---------------------|---------------------------------------|---|-----------------|--------------|------------------------|
| PG8. +879140108 EC NO: S2010-0695 DRWN:ATSEE 2010/02/11 CHKD:PTLIM 2004/12/08 APPR:MLONG 2010/06/05 D7 | QUALITY SYMBOLS | GENERAL TOLERANCES (UNLESS SPECIFIED) | DIMENSION STYLE | SCALE | DESIGN UNITS | THIRD ANGLE PROJECTION |
| | $F_A=0$ | mm INCH | MM ONLY | NTS | METRIC | |
| | $F_G=0$ | 4 PLACES ± --- ± --- | DRAWN BY DATE | TITLE | | |
| | $F_P=0$ | 3 PLACES ± --- ± --- | KCHO 2004/11/05 | 2.54MM PITCH | | |
| | | 2 PLACES ± 0.20 ± --- | CHECKED BY DATE | DUAL ROW HEADER | | |
| | 1 PLACE ± --- ± --- | PTLIM 2004/12/08 | SINGLE WAFER, T/H | | | |
| | ANGULAR ± 3 ° | APPROVED BY DATE | MOLEX INCORPORATED | | | |
| | | SCLOW 2004/12/10 | MATERIAL NO. | DOCUMENT NO. | | SHEET NO. |
| | | | SEE TABLE | SD-87914-013 | | 38 OF 46 |
| | | | THIS DRAWING CONTAINS INFORMATION THAT IS PROPRIETARY TO MOLEX INCORPORATED AND SHOULD NOT BE USED WITHOUT WRITTEN PERMISSION | | | |

| | 10 | 9 | 8 | 7 | 6 | 5 | 4 | 3 | 2 | 1 | | | |
|---|----------------------------|---|--------------------------------------|--|---|----------|---------------|--------------|-----------|-------|-------|------|------|
| | PART NO FOR BULK PACKAGING | PART NO. FOR TUBE WITHOUT CAP PACKAGING | PART NO. FOR TUBE WITH CAP PACKAGING | PART NO. FOR TAPE & REEL WITHOUT CAP PACKAGING | PART NO. FOR TAPE & REEL WITH CAP PACKAGING | CKT SIZE | VOID POSITION | PLATING TYPE | DIMENSION | | | | |
| | | | | | | | | | A | B | F | M | P |
| F | 87914-6611 | ----- | ----- | ----- | ----- | 66 | ---- | 1 | 83.82 | 81.28 | 10.92 | 5.84 | 2.79 |
| | 87914-6621 | ----- | ----- | ----- | ----- | 66 | ---- | 1 | 83.82 | 81.28 | 12.25 | 7.00 | 2.96 |
| | 87914-6612 | ----- | ----- | ----- | ----- | 66 | ---- | 2 | 83.82 | 81.28 | 10.92 | 5.84 | 2.79 |
| | 87914-6622 | ----- | ----- | ----- | ----- | 66 | ---- | 2 | 83.82 | 81.28 | 12.25 | 7.00 | 2.96 |
| | 87914-6613 | ----- | ----- | ----- | ----- | 66 | ---- | 3 | 83.82 | 81.28 | 10.92 | 5.84 | 2.79 |
| | 87914-6623 | ----- | ----- | ----- | ----- | 66 | ---- | 3 | 83.82 | 81.28 | 12.25 | 7.00 | 2.96 |
| E | 87914-6614 | ----- | ----- | ----- | ----- | 66 | ---- | 4 | 83.82 | 81.28 | 10.92 | 5.84 | 2.79 |
| | 87914-6624 | ----- | ----- | ----- | ----- | 66 | ---- | 4 | 83.82 | 81.28 | 12.25 | 7.00 | 2.96 |
| | 87914-6615 | ----- | ----- | ----- | ----- | 66 | ---- | 5 | 83.82 | 81.28 | 10.92 | 5.84 | 2.79 |
| | 87914-6625 | ----- | ----- | ----- | ----- | 66 | ---- | 5 | 83.82 | 81.28 | 12.25 | 7.00 | 2.96 |
| | 87914-6616 | ----- | ----- | ----- | ----- | 66 | ---- | 6 | 83.82 | 81.28 | 10.92 | 5.84 | 2.79 |
| | 87914-6626 | ----- | ----- | ----- | ----- | 66 | ---- | 6 | 83.82 | 81.28 | 12.25 | 7.00 | 2.96 |
| D | | | | | | | | | | | | | |
| | | | | | | | | | | | | | |
| | | | | | | | | | | | | | |
| | | | | | | | | | | | | | |
| C | | | | | | | | | | | | | |
| | | | | | | | | | | | | | |
| | | | | | | | | | | | | | |
| | | | | | | | | | | | | | |
| | | | | | | | | | | | | | |
| B | | | | | | | | | | | | | |
| | | | | | | | | | | | | | |

| PG8. +879140108 EC NO: S2010-0695 DRWN:ATSEE 2010/02/11 CHKD:PTLIM 2004/12/08 APPR:MLONG 2010/06/05 D7 | QUALITY SYMBOLS $\nabla_A=0$ $\nabla_C=0$ $\nabla_P=0$ | GENERAL TOLERANCES (UNLESS SPECIFIED) <table border="1"> <thead> <tr> <th></th> <th>mm</th> <th>INCH</th> </tr> </thead> <tbody> <tr> <td>4 PLACES</td> <td>± ---</td> <td>± ---</td> </tr> <tr> <td>3 PLACES</td> <td>± ---</td> <td>± ---</td> </tr> <tr> <td>2 PLACES</td> <td>± 0.20</td> <td>± ---</td> </tr> <tr> <td>1 PLACE</td> <td>± ---</td> <td>± ---</td> </tr> </tbody> </table> | | mm | INCH | 4 PLACES | ± --- | ± --- | 3 PLACES | ± --- | ± --- | 2 PLACES | ± 0.20 | ± --- | 1 PLACE | ± --- | ± --- | DIMENSION STYLE MM ONLY | SCALE NTS | DESIGN UNITS METRIC | THIRD ANGLE PROJECTION |
|---|--|--|---------------------------|--|-------------------------------------|------------------------------|-------|-------|----------|-------|-------|----------|--------|-------|---------|-------|-------|--|---------------------|-------------------------------|-------------------------------|
| | | mm | INCH | | | | | | | | | | | | | | | | | | |
| | 4 PLACES | ± --- | ± --- | | | | | | | | | | | | | | | | | | |
| | 3 PLACES | ± --- | ± --- | | | | | | | | | | | | | | | | | | |
| 2 PLACES | ± 0.20 | ± --- | | | | | | | | | | | | | | | | | | | |
| 1 PLACE | ± --- | ± --- | | | | | | | | | | | | | | | | | | | |
| DESCRIPTION DRAFT WHERE APPLICABLE MUST REMAIN WITHIN DIMENSIONS | | DRAWN BY KCHO | DATE 2004/11/05 | TITLE 2.54MM PITCH DUAL ROW HEADER SINGLE WAFER, T/H | | | | | | | | | | | | | | | | | |
| | | CHECKED BY PTLIM | DATE 2004/12/08 | MOLEX INCORPORATED | | | | | | | | | | | | | | | | | |
| | | APPROVED BY SCLOW | DATE 2004/12/10 | MATERIAL NO. SEE TABLE | DOCUMENT NO. SD-87914-013 | SHEET NO. 39 OF 46 | | | | | | | | | | | | | | | |

| PART NO FOR BULK PACKAGING | PART NO. FOR TUBE WITHOUT CAP PACKAGING | PART NO. FOR TUBE WITH CAP PACKAGING | PART NO. FOR TAPE & REEL WITHOUT CAP PACKAGING | PART NO. FOR TAPE & REEL WITH CAP PACKAGING | CKT SIZE | VOID POSITION | PLATING TYPE | DIMENSION | | | | |
|----------------------------|---|--------------------------------------|--|---|----------|---------------|--------------|------------|-------|-------|-------|-------|
| | | | | | | | | A | B | F | M | P |
| | | | | | | | | 87914-6811 | ----- | ----- | ----- | ----- |
| 87914-6821 | ----- | ----- | ----- | ----- | 68 | ---- | 1 | 86.36 | 83.82 | 12.25 | 7.00 | 2.96 |
| 87914-6812 | ----- | ----- | ----- | ----- | 68 | ---- | 2 | 86.36 | 83.82 | 10.92 | 5.84 | 2.79 |
| 87914-6822 | ----- | ----- | ----- | ----- | 68 | ---- | 2 | 86.36 | 83.82 | 12.25 | 7.00 | 2.96 |
| 87914-6813 | ----- | ----- | ----- | ----- | 68 | ---- | 3 | 86.36 | 83.82 | 10.92 | 5.84 | 2.79 |
| 87914-6823 | ----- | ----- | ----- | ----- | 68 | ---- | 3 | 86.36 | 83.82 | 12.25 | 7.00 | 2.96 |
| 87914-6814 | ----- | ----- | ----- | ----- | 68 | ---- | 4 | 86.36 | 83.82 | 10.92 | 5.84 | 2.79 |
| 87914-6824 | ----- | ----- | ----- | ----- | 68 | ---- | 4 | 86.36 | 83.82 | 12.25 | 7.00 | 2.96 |
| 87914-6815 | ----- | ----- | ----- | ----- | 68 | ---- | 5 | 86.36 | 83.82 | 10.92 | 5.84 | 2.79 |
| 87914-6825 | ----- | ----- | ----- | ----- | 68 | ---- | 5 | 86.36 | 83.82 | 12.25 | 7.00 | 2.96 |
| 87914-6816 | ----- | ----- | ----- | ----- | 68 | ---- | 6 | 86.36 | 83.82 | 10.92 | 5.84 | 2.79 |
| 87914-6826 | ----- | ----- | ----- | ----- | 68 | ---- | 6 | 86.36 | 83.82 | 12.25 | 7.00 | 2.96 |

| | | | | | | | | | |
|--|--|--|---|--|--|-----------------------------|------------------------|------------------------|--|
| PG8. +879140108 EC NO: S2010-0695 DRWN:ATSEE 2010/02/11 CHKD:PTLIM 2004/12/08 APPR:MLONG 2010/06/05 | QUALITY SYMBOLS $F_A=0$ $F_G=0$ $F_P=0$ | GENERAL TOLERANCES (UNLESS SPECIFIED) mm INCH | | DIMENSION STYLE MM ONLY | | SCALE NTS | DESIGN UNITS METRIC | THIRD ANGLE PROJECTION | |
| | | 4 PLACES ± --- ± --- 3 PLACES ± --- ± --- 2 PLACES ± 0.20 ± --- 1 PLACE ± --- ± --- | DRAWN BY: KCHO CHECKED BY: PTLIM APPROVED BY: SCLOW | DATE: 2004/11/05 DATE: 2004/12/08 DATE: 2004/12/10 | TITLE 2.54MM PITCH DUAL ROW HEADER SINGLE WAFER, T/H | | | | |
| | | ANGULAR ± 3 ° | | MATERIAL NO. DOCUMENT NO. | | SEE TABLE SD-87914-013 | | SHEET NO. 40 OF 46 | |
| DRAFT WHERE APPLICABLE MUST REMAIN WITHIN DIMENSIONS | | | | THIS DRAWING CONTAINS INFORMATION THAT IS PROPRIETARY TO MOLEX INCORPORATED AND SHOULD NOT BE USED WITHOUT WRITTEN PERMISSION | | | | | |

| | 10 | 9 | 8 | 7 | 6 | 5 | 4 | 3 | 2 | 1 | | | |
|---|-----------------------------|---|--------------------------------------|--|---|----------|---------------|--------------|-----------|-------|-------|------|------|
| | PART NO. FOR BULK PACKAGING | PART NO. FOR TUBE WITHOUT CAP PACKAGING | PART NO. FOR TUBE WITH CAP PACKAGING | PART NO. FOR TAPE & REEL WITHOUT CAP PACKAGING | PART NO. FOR TAPE & REEL WITH CAP PACKAGING | CKT SIZE | VOID POSITION | PLATING TYPE | DIMENSION | | | | |
| | | | | | | | | | A | B | F | M | P |
| F | 87914-7011 | ----- | ----- | ----- | ----- | 70 | ---- | 1 | 88.90 | 86.36 | 10.92 | 5.84 | 2.79 |
| | 87914-7021 | ----- | ----- | ----- | ----- | 70 | ---- | 1 | 88.90 | 86.36 | 12.25 | 7.00 | 2.96 |
| | 87914-7012 | ----- | ----- | ----- | ----- | 70 | ---- | 2 | 88.90 | 86.36 | 10.92 | 5.84 | 2.79 |
| | 87914-7022 | ----- | ----- | ----- | ----- | 70 | ---- | 2 | 88.90 | 86.36 | 12.25 | 7.00 | 2.96 |
| | 87914-7013 | ----- | ----- | ----- | ----- | 70 | ---- | 3 | 88.90 | 86.36 | 10.92 | 5.84 | 2.79 |
| | 87914-7023 | ----- | ----- | ----- | ----- | 70 | ---- | 3 | 88.90 | 86.36 | 12.25 | 7.00 | 2.96 |
| E | 87914-7014 | ----- | ----- | ----- | ----- | 70 | ---- | 4 | 88.90 | 86.36 | 10.92 | 5.84 | 2.79 |
| | 87914-7024 | ----- | ----- | ----- | ----- | 70 | ---- | 4 | 88.90 | 86.36 | 12.25 | 7.00 | 2.96 |
| | 87914-7015 | ----- | ----- | ----- | ----- | 70 | ---- | 5 | 88.90 | 86.36 | 10.92 | 5.84 | 2.79 |
| | 87914-7025 | ----- | ----- | ----- | ----- | 70 | ---- | 5 | 88.90 | 86.36 | 12.25 | 7.00 | 2.96 |
| | 87914-7016 | ----- | ----- | ----- | ----- | 70 | ---- | 6 | 88.90 | 86.36 | 10.92 | 5.84 | 2.79 |
| | 87914-7026 | ----- | ----- | ----- | ----- | 70 | ---- | 6 | 88.90 | 86.36 | 12.25 | 7.00 | 2.96 |
| D | | | | | | | | | | | | | |
| | | | | | | | | | | | | | |
| | | | | | | | | | | | | | |
| | | | | | | | | | | | | | |
| C | | | | | | | | | | | | | |
| | | | | | | | | | | | | | |
| | | | | | | | | | | | | | |
| | | | | | | | | | | | | | |
| B | | | | | | | | | | | | | |
| | | | | | | | | | | | | | |

| | | | | | | | | |
|--|--|---------------------------------------|--|-----------------------------------|---|--|------------------------------|-----------------------|
| PG8, +879140108 EC NO: S2010-0695 DRWN:ATSEE 2010/02/11 CHKD:PTLIM 2004/12/08 APPR:MLONG 2010/06/05 | QUALITY SYMBOLS $F_A=0$ $F_G=0$ $F_P=0$ | GENERAL TOLERANCES (UNLESS SPECIFIED) | | DIMENSION STYLE MM ONLY | SCALE NTS | DESIGN UNITS METRIC | THIRD ANGLE PROJECTION | |
| | | | | DRAWN BY KCHO | DATE 2004/11/05 | TITLE 2.54MM PITCH DUAL ROW HEADER SINGLE WAFER, T/H | | |
| | | | | CHECKED BY PTLIM | DATE 2004/12/08 | molex MOLEX INCORPORATED | | |
| | | | | APPROVED BY SCLOW | DATE 2004/12/10 | MATERIAL NO. SEE TABLE | DOCUMENT NO. SD-87914-013 | SHEET NO. 41 OF 46 |
| DRAFT WHERE APPLICABLE MUST REMAIN WITHIN DIMENSIONS | | | | SIZE A3 | THIS DRAWING CONTAINS INFORMATION THAT IS PROPRIETARY TO MOLEX INCORPORATED AND SHOULD NOT BE USED WITHOUT WRITTEN PERMISSION | | | |

| 10 | | 9 | | 8 | | 7 | | 6 | | 5 | | | 4 | | 3 | | 2 | | 1 | |
|----|----------------------------|---|--------------------------------------|--|---|----------|---------------|--------------|-----------|-------|-------|------|------|--|---|--|---|--|---|--|
| F | PART NO FOR BULK PACKAGING | PART NO. FOR TUBE WITHOUT CAP PACKAGING | PART NO. FOR TUBE WITH CAP PACKAGING | PART NO. FOR TAPE & REEL WITHOUT CAP PACKAGING | PART NO. FOR TAPE & REEL WITH CAP PACKAGING | CKT SIZE | VOID POSITION | PLATING TYPE | DIMENSION | | | | | | | | | | | |
| | A | B | F | M | P | | | | | | | | | | | | | | | |
| | 87914-7211 | ----- | ----- | ----- | ----- | 72 | ---- | 1 | 91.44 | 88.90 | 10.92 | 5.84 | 2.79 | | | | | | | |
| | 87914-7221 | ----- | ----- | ----- | ----- | 72 | ---- | 1 | 91.44 | 88.90 | 12.25 | 7.00 | 2.96 | | | | | | | |
| | 87914-7212 | ----- | ----- | ----- | ----- | 72 | ---- | 2 | 91.44 | 88.90 | 10.92 | 5.84 | 2.79 | | | | | | | |
| | 87914-7222 | ----- | ----- | ----- | ----- | 72 | ---- | 2 | 91.44 | 88.90 | 12.25 | 7.00 | 2.96 | | | | | | | |
| | 87914-7213 | ----- | ----- | ----- | ----- | 72 | ---- | 3 | 91.44 | 88.90 | 10.92 | 5.84 | 2.79 | | | | | | | |
| | 87914-7223 | ----- | ----- | ----- | ----- | 72 | ---- | 3 | 91.44 | 88.90 | 12.25 | 7.00 | 2.96 | | | | | | | |
| E | 87914-7214 | ----- | ----- | ----- | ----- | 72 | ---- | 4 | 91.44 | 88.90 | 10.92 | 5.84 | 2.79 | | | | | | | |
| | 87914-7224 | ----- | ----- | ----- | ----- | 72 | ---- | 4 | 91.44 | 88.90 | 12.25 | 7.00 | 2.96 | | | | | | | |
| | 87914-7215 | ----- | ----- | ----- | ----- | 72 | ---- | 5 | 91.44 | 88.90 | 10.92 | 5.84 | 2.79 | | | | | | | |
| | 87914-7225 | ----- | ----- | ----- | ----- | 72 | ---- | 5 | 91.44 | 88.90 | 12.25 | 7.00 | 2.96 | | | | | | | |
| | 87914-7216 | ----- | ----- | ----- | ----- | 72 | ---- | 6 | 91.44 | 88.90 | 10.92 | 5.84 | 2.79 | | | | | | | |
| | 87914-7226 | ----- | ----- | ----- | ----- | 72 | ---- | 6 | 91.44 | 88.90 | 12.25 | 7.00 | 2.96 | | | | | | | |
| D | | | | | | | | | | | | | | | | | | | | |
| | | | | | | | | | | | | | | | | | | | | |
| | | | | | | | | | | | | | | | | | | | | |
| | | | | | | | | | | | | | | | | | | | | |
| | | | | | | | | | | | | | | | | | | | | |
| C | | | | | | | | | | | | | | | | | | | | |
| | | | | | | | | | | | | | | | | | | | | |
| | | | | | | | | | | | | | | | | | | | | |
| | | | | | | | | | | | | | | | | | | | | |
| B | | | | | | | | | | | | | | | | | | | | |

| | | | | | | | | | | | | | | | | | | | | | | |
|---|--------------------|--|---|--|----|------|----------|-------|-------|----------|-------|-------|----------|--------|-------|---------|-------|-------|---|--|--|--|
| PG8. +879140108 EC NO: S2010-0695 DRWN:ATSEE 2010/02/11 CHKD:PTLIM 2004/12/08 APPR:MLONG 2010/06/05 D7 | REV DESCRIPTION | QUALITY SYMBOLS $F_A = 0$ $F_G = 0$ $F_P = 0$ | GENERAL TOLERANCES (UNLESS SPECIFIED) <table border="1"> <tr><td></td><td>mm</td><td>INCH</td></tr> <tr><td>4 PLACES</td><td>± ---</td><td>± ---</td></tr> <tr><td>3 PLACES</td><td>± ---</td><td>± ---</td></tr> <tr><td>2 PLACES</td><td>± 0.20</td><td>± ---</td></tr> <tr><td>1 PLACE</td><td>± ---</td><td>± ---</td></tr> </table> | | mm | INCH | 4 PLACES | ± --- | ± --- | 3 PLACES | ± --- | ± --- | 2 PLACES | ± 0.20 | ± --- | 1 PLACE | ± --- | ± --- | DIMENSION STYLE MM ONLY DRAWN BY: KCHO CHECKED BY: PTLIM APPROVED BY: SCLOW DATE: 2004/11/05 DATE: 2004/12/08 DATE: 2004/12/10 | SCALE NTS DESIGN UNITS METRIC THIRD ANGLE PROJECTION | TITLE 2.54MM PITCH DUAL ROW HEADER SINGLE WAFER, T/H MOLEX INCORPORATED DOCUMENT NO. SD-87914-013 SHEET NO. 42 OF 46 | DRAFT WHERE APPLICABLE MUST REMAIN WITHIN DIMENSIONS SEE TABLE THIS DRAWING CONTAINS INFORMATION THAT IS PROPRIETARY TO MOLEX INCORPORATED AND SHOULD NOT BE USED WITHOUT WRITTEN PERMISSION |
| | | mm | INCH | | | | | | | | | | | | | | | | | | | |
| | 4 PLACES | ± --- | ± --- | | | | | | | | | | | | | | | | | | | |
| 3 PLACES | ± --- | ± --- | | | | | | | | | | | | | | | | | | | | |
| 2 PLACES | ± 0.20 | ± --- | | | | | | | | | | | | | | | | | | | | |
| 1 PLACE | ± --- | ± --- | | | | | | | | | | | | | | | | | | | | |

| | 10 | 9 | 8 | 7 | 6 | 5 | 4 | 3 | 2 | 1 | | | |
|---|----------------------------|---|--------------------------------------|--|---|----------|---------------|--------------|-----------|-------|-------|------|------|
| | PART NO FOR BULK PACKAGING | PART NO. FOR TUBE WITHOUT CAP PACKAGING | PART NO. FOR TUBE WITH CAP PACKAGING | PART NO. FOR TAPE & REEL WITHOUT CAP PACKAGING | PART NO. FOR TAPE & REEL WITH CAP PACKAGING | CKT SIZE | VOID POSITION | PLATING TYPE | DIMENSION | | | | |
| | A | B | F | M | P | | | | | | | | |
| F | 87914-7411 | ----- | ----- | ----- | ----- | 74 | ---- | 1 | 93.98 | 91.44 | 10.92 | 5.84 | 2.79 |
| | 87914-7421 | ----- | ----- | ----- | ----- | 74 | ---- | 1 | 93.98 | 91.44 | 12.25 | 7.00 | 2.96 |
| | 87914-7412 | ----- | ----- | ----- | ----- | 74 | ---- | 2 | 93.98 | 91.44 | 10.92 | 5.84 | 2.79 |
| | 87914-7422 | ----- | ----- | ----- | ----- | 74 | ---- | 2 | 93.98 | 91.44 | 12.25 | 7.00 | 2.96 |
| | 87914-7413 | ----- | ----- | ----- | ----- | 74 | ---- | 3 | 93.98 | 91.44 | 10.92 | 5.84 | 2.79 |
| | 87914-7423 | ----- | ----- | ----- | ----- | 74 | ---- | 3 | 93.98 | 91.44 | 12.25 | 7.00 | 2.96 |
| E | 87914-7414 | ----- | ----- | ----- | ----- | 74 | ---- | 4 | 93.98 | 91.44 | 10.92 | 5.84 | 2.79 |
| | 87914-7424 | ----- | ----- | ----- | ----- | 74 | ---- | 4 | 93.98 | 91.44 | 12.25 | 7.00 | 2.96 |
| | 87914-7415 | ----- | ----- | ----- | ----- | 74 | ---- | 5 | 93.98 | 91.44 | 10.92 | 5.84 | 2.79 |
| | 87914-7425 | ----- | ----- | ----- | ----- | 74 | ---- | 5 | 93.98 | 91.44 | 12.25 | 7.00 | 2.96 |
| | 87914-7416 | ----- | ----- | ----- | ----- | 74 | ---- | 6 | 93.98 | 91.44 | 10.92 | 5.84 | 2.79 |
| | 87914-7426 | ----- | ----- | ----- | ----- | 74 | ---- | 6 | 93.98 | 91.44 | 12.25 | 7.00 | 2.96 |
| D | | | | | | | | | | | | | |
| | | | | | | | | | | | | | |
| | | | | | | | | | | | | | |
| | | | | | | | | | | | | | |
| | | | | | | | | | | | | | |
| C | | | | | | | | | | | | | |
| | | | | | | | | | | | | | |
| | | | | | | | | | | | | | |
| | | | | | | | | | | | | | |
| | | | | | | | | | | | | | |
| B | | | | | | | | | | | | | |
| | | | | | | | | | | | | | |
| | | | | | | | | | | | | | |

| PG8. +879140108 EC NO: S2010-0695 DRWN:ATSEE 2010/02/11 CHKD:PTLIM 2004/12/08 APPR:MLONG 2010/06/05 D7 | QUALITY SYMBOLS $F_A=0$ $F_C=0$ $F_P=0$ | GENERAL TOLERANCES (UNLESS SPECIFIED) <table border="1"> <tr><th colspan="2">mm</th><th>INCH</th></tr> <tr><td>4 PLACES</td><td>± ---</td><td>± ---</td></tr> <tr><td>3 PLACES</td><td>± ---</td><td>± ---</td></tr> <tr><td>2 PLACES</td><td>± 0.20</td><td>± ---</td></tr> <tr><td>1 PLACE</td><td>± ---</td><td>± ---</td></tr> </table> | mm | | INCH | 4 PLACES | ± --- | ± --- | 3 PLACES | ± --- | ± --- | 2 PLACES | ± 0.20 | ± --- | 1 PLACE | ± --- | ± --- | DIMENSION STYLE MM ONLY | SCALE NTS | DESIGN UNITS METRIC | THIRD ANGLE PROJECTION |
|---|--|--|---|--|------|----------|-------|-------|----------|-------|-------|----------|--------|-------|---------|-------|-------|-----------------------------------|---------------------|-------------------------------|------------------------|
| | mm | | INCH | | | | | | | | | | | | | | | | | | |
| | 4 PLACES | ± --- | ± --- | | | | | | | | | | | | | | | | | | |
| | 3 PLACES | ± --- | ± --- | | | | | | | | | | | | | | | | | | |
| 2 PLACES | ± 0.20 | ± --- | | | | | | | | | | | | | | | | | | | |
| 1 PLACE | ± --- | ± --- | | | | | | | | | | | | | | | | | | | |
| DRAWN BY KCHO | DATE 2004/11/05 | TITLE 2.54MM PITCH DUAL ROW HEADER SINGLE WAFER, T/H | | | | | | | | | | | | | | | | | | | |
| CHECKED BY PTLIM | DATE 2004/12/08 | MOLEX INCORPORATED | | | | | | | | | | | | | | | | | | | |
| APPROVED BY SCLOW | DATE 2004/12/10 | MATERIAL NO. SEE TABLE | | | | | | | | | | | | | | | | | | | |
| DRAFT WHERE APPLICABLE MUST REMAIN WITHIN DIMENSIONS | | DOCUMENT NO. SD-87914-013 | SHEET NO. 43 OF 46 | | | | | | | | | | | | | | | | | | |
| SIZE A3 | | | THIS DRAWING CONTAINS INFORMATION THAT IS PROPRIETARY TO MOLEX INCORPORATED AND SHOULD NOT BE USED WITHOUT WRITTEN PERMISSION | | | | | | | | | | | | | | | | | | |

| PART NO FOR BULK PACKAGING | PART NO. FOR TUBE WITHOUT CAP PACKAGING | PART NO. FOR TUBE WITH CAP PACKAGING | PART NO. FOR TAPE & REEL WITHOUT CAP PACKAGING | PART NO. FOR TAPE & REEL WITH CAP PACKAGING | CKT SIZE | VOID POSITION | PLATING TYPE | DIMENSION | | | | |
|----------------------------|---|--------------------------------------|--|---|----------|---------------|--------------|-----------|-------|-------|------|------|
| | | | | | | | | A | B | C | D | E |
| 87914-7611 | ----- | ----- | ----- | ----- | 76 | ---- | 1 | 96.52 | 93.98 | 10.92 | 5.84 | 2.79 |
| 87914-7621 | ----- | ----- | ----- | ----- | 76 | ---- | 1 | 96.52 | 93.98 | 12.25 | 7.00 | 2.96 |
| 87914-7612 | ----- | ----- | ----- | ----- | 76 | ---- | 2 | 96.52 | 93.98 | 10.92 | 5.84 | 2.79 |
| 87914-7622 | ----- | ----- | ----- | ----- | 76 | ---- | 2 | 96.52 | 93.98 | 12.25 | 7.00 | 2.96 |
| 87914-7613 | ----- | ----- | ----- | ----- | 76 | ---- | 3 | 96.52 | 93.98 | 10.92 | 5.84 | 2.79 |
| 87914-7623 | ----- | ----- | ----- | ----- | 76 | ---- | 3 | 96.52 | 93.98 | 12.25 | 7.00 | 2.96 |
| 87914-7614 | ----- | ----- | ----- | ----- | 76 | ---- | 4 | 96.52 | 93.98 | 10.92 | 5.84 | 2.79 |
| 87914-7624 | ----- | ----- | ----- | ----- | 76 | ---- | 4 | 96.52 | 93.98 | 12.25 | 7.00 | 2.96 |
| 87914-7615 | ----- | ----- | ----- | ----- | 76 | ---- | 5 | 96.52 | 93.98 | 10.92 | 5.84 | 2.79 |
| 87914-7625 | ----- | ----- | ----- | ----- | 76 | ---- | 5 | 96.52 | 93.98 | 12.25 | 7.00 | 2.96 |
| 87914-7616 | ----- | ----- | ----- | ----- | 76 | ---- | 6 | 96.52 | 93.98 | 10.92 | 5.84 | 2.79 |
| 87914-7626 | ----- | ----- | ----- | ----- | 76 | ---- | 6 | 96.52 | 93.98 | 12.25 | 7.00 | 2.96 |
| | | | | | | | | | | | | |
| | | | | | | | | | | | | |
| | | | | | | | | | | | | |
| | | | | | | | | | | | | |
| | | | | | | | | | | | | |
| | | | | | | | | | | | | |
| | | | | | | | | | | | | |
| | | | | | | | | | | | | |
| | | | | | | | | | | | | |
| | | | | | | | | | | | | |
| | | | | | | | | | | | | |
| | | | | | | | | | | | | |
| | | | | | | | | | | | | |
| | | | | | | | | | | | | |

| | | | | | | | |
|--|---------------------|---|---|--------------------|--|------------------------|-----------|
| PG8. +879140108 EC NO: S2010-0695 DRWN:ATSEE 2010/02/11 CHKD:PTLIM 2004/12/08 APPR:MLONG 2010/06/05 D7 | QUALITY SYMBOLS | GENERAL TOLERANCES (UNLESS SPECIFIED) | DIMENSION STYLE MM ONLY | SCALE NTS | DESIGN UNITS METRIC | THIRD ANGLE PROJECTION | |
| | $F_A=0$ | mm INCH | DRAWN BY KCHO | DATE 2004/11/05 | TITLE 2.54MM PITCH DUAL ROW HEADER SINGLE WAFER, T/H | | |
| | $F_C=0$ | 4 PLACES ± --- ± --- | CHECKED BY PTLIM | DATE 2004/12/08 | MOLEX INCORPORATED | | |
| | $F_P=0$ | 3 PLACES ± --- ± --- | APPROVED BY SCLOW | DATE 2004/12/10 | MATERIAL NO. | DOCUMENT NO. | SHEET NO. |
| | | 2 PLACES ± 0.20 ± --- | SEE TABLE SD-87914-013 44 OF 46 | | | | |
| | 1 PLACE ± --- ± --- | DRAFT WHERE APPLICABLE MUST REMAIN WITHIN DIMENSIONS | | | | | |
| | | ANGULAR ± 3 ° | | | | | |
| | | THIS DRAWING CONTAINS INFORMATION THAT IS PROPRIETARY TO MOLEX INCORPORATED AND SHOULD NOT BE USED WITHOUT WRITTEN PERMISSION | | | | | |

| | 10 | 9 | 8 | 7 | 6 | 5 | 4 | 3 | 2 | 1 | | | |
|---|----------------------------|---|--------------------------------------|--|---|----------|---------------|--------------|-----------|-------|-------|------|------|
| | PART NO FOR BULK PACKAGING | PART NO. FOR TUBE WITHOUT CAP PACKAGING | PART NO. FOR TUBE WITH CAP PACKAGING | PART NO. FOR TAPE & REEL WITHOUT CAP PACKAGING | PART NO. FOR TAPE & REEL WITH CAP PACKAGING | CKT SIZE | VOID POSITION | PLATING TYPE | DIMENSION | | | | |
| | A | B | F | M | P | | | | | | | | |
| F | 87914-7811 | ----- | ----- | ----- | ----- | 78 | ---- | 1 | 99.06 | 96.52 | 10.92 | 5.84 | 2.79 |
| | 87914-7821 | ----- | ----- | ----- | ----- | 78 | ---- | 1 | 99.06 | 96.52 | 12.25 | 7.00 | 2.96 |
| | 87914-7812 | ----- | ----- | ----- | ----- | 78 | ---- | 2 | 99.06 | 96.52 | 10.92 | 5.84 | 2.79 |
| | 87914-7822 | ----- | ----- | ----- | ----- | 78 | ---- | 2 | 99.06 | 96.52 | 12.25 | 7.00 | 2.96 |
| | 87914-7813 | ----- | ----- | ----- | ----- | 78 | ---- | 3 | 99.06 | 96.52 | 10.92 | 5.84 | 2.79 |
| | 87914-7823 | ----- | ----- | ----- | ----- | 78 | ---- | 3 | 99.06 | 96.52 | 12.25 | 7.00 | 2.96 |
| E | 87914-7814 | ----- | ----- | ----- | ----- | 78 | ---- | 4 | 99.06 | 96.52 | 10.92 | 5.84 | 2.79 |
| | 87914-7824 | ----- | ----- | ----- | ----- | 78 | ---- | 4 | 99.06 | 96.52 | 12.25 | 7.00 | 2.96 |
| | 87914-7815 | ----- | ----- | ----- | ----- | 78 | ---- | 5 | 99.06 | 96.52 | 10.92 | 5.84 | 2.79 |
| | 87914-7825 | ----- | ----- | ----- | ----- | 78 | ---- | 5 | 99.06 | 96.52 | 12.25 | 7.00 | 2.96 |
| | 87914-7816 | ----- | ----- | ----- | ----- | 78 | ---- | 6 | 99.06 | 96.52 | 10.92 | 5.84 | 2.79 |
| | 87914-7826 | ----- | ----- | ----- | ----- | 78 | ---- | 6 | 99.06 | 96.52 | 12.25 | 7.00 | 2.96 |
| D | | | | | | | | | | | | | |
| | | | | | | | | | | | | | |
| | | | | | | | | | | | | | |
| | | | | | | | | | | | | | |
| C | | | | | | | | | | | | | |
| | | | | | | | | | | | | | |
| | | | | | | | | | | | | | |
| | | | | | | | | | | | | | |
| B | | | | | | | | | | | | | |

| PG8. +879140108 EC NO: S2010-0695 DRW: NATSEE 2010/02/11 CHKD: PTLIM 2004/12/08 APPR: MLONG 2010/06/05 | DESCRIPTION REV | $F_A = 0$ $F_G = 0$ $F_P = 0$ | QUALITY SYMBOLS | GENERAL TOLERANCES (UNLESS SPECIFIED) | DIMENSION STYLE MM ONLY | SCALE NTS | DESIGN UNITS METRIC | THIRD ANGLE PROJECTION | | | | | | | | | | | | | | | | | | | | | | | | | | | | | |
|---|--------------------|---|---|--|--|---|--------------------------------------|-------------------------------|-------|-------|----------|-------|-------|----------|--------|-------|---------|-------|-------|--|----------|------|-------|------|------------|---|------------|------|-------|------------|-------------|------|--|-------|------------|--|---------------------------|
| | | | | <table border="1"> <tr> <th></th> <th>mm</th> <th>INCH</th> </tr> <tr> <td>4 PLACES</td> <td>± ---</td> <td>± ---</td> </tr> <tr> <td>3 PLACES</td> <td>± ---</td> <td>± ---</td> </tr> <tr> <td>2 PLACES</td> <td>± 0.20</td> <td>± ---</td> </tr> <tr> <td>1 PLACE</td> <td>± ---</td> <td>± ---</td> </tr> </table> | | mm | INCH | 4 PLACES | ± --- | ± --- | 3 PLACES | ± --- | ± --- | 2 PLACES | ± 0.20 | ± --- | 1 PLACE | ± --- | ± --- | <table border="1"> <tr> <th>DRAWN BY</th> <th>DATE</th> <th>TITLE</th> </tr> <tr> <td>KCHO</td> <td>2004/11/05</td> <td rowspan="3"> 2.54MM PITCH DUAL ROW HEADER SINGLE WAFER, T/H </td> </tr> <tr> <th>CHECKED BY</th> <th>DATE</th> </tr> <tr> <td>PTLIM</td> <td>2004/12/08</td> </tr> <tr> <th>APPROVED BY</th> <th>DATE</th> <td></td> </tr> <tr> <td>SCLOW</td> <td>2004/12/10</td> <td></td> </tr> </table> | DRAWN BY | DATE | TITLE | KCHO | 2004/11/05 | 2.54MM PITCH DUAL ROW HEADER SINGLE WAFER, T/H | CHECKED BY | DATE | PTLIM | 2004/12/08 | APPROVED BY | DATE | | SCLOW | 2004/12/10 | | MOLEX INCORPORATED |
| | | | mm | INCH | | | | | | | | | | | | | | | | | | | | | | | | | | | | | | | | | |
| | | 4 PLACES | ± --- | ± --- | | | | | | | | | | | | | | | | | | | | | | | | | | | | | | | | | |
| 3 PLACES | ± --- | ± --- | | | | | | | | | | | | | | | | | | | | | | | | | | | | | | | | | | | |
| 2 PLACES | ± 0.20 | ± --- | | | | | | | | | | | | | | | | | | | | | | | | | | | | | | | | | | | |
| 1 PLACE | ± --- | ± --- | | | | | | | | | | | | | | | | | | | | | | | | | | | | | | | | | | | |
| DRAWN BY | DATE | TITLE | | | | | | | | | | | | | | | | | | | | | | | | | | | | | | | | | | | |
| KCHO | 2004/11/05 | 2.54MM PITCH DUAL ROW HEADER SINGLE WAFER, T/H | | | | | | | | | | | | | | | | | | | | | | | | | | | | | | | | | | | |
| CHECKED BY | DATE | | | | | | | | | | | | | | | | | | | | | | | | | | | | | | | | | | | | |
| PTLIM | 2004/12/08 | | | | | | | | | | | | | | | | | | | | | | | | | | | | | | | | | | | | |
| APPROVED BY | DATE | | | | | | | | | | | | | | | | | | | | | | | | | | | | | | | | | | | | |
| SCLOW | 2004/12/10 | | | | | | | | | | | | | | | | | | | | | | | | | | | | | | | | | | | | |
| | | | DRAFT WHERE APPLICABLE MUST REMAIN WITHIN DIMENSIONS | SEE TABLE | MATERIAL NO. SD-87914-013 | DOCUMENT NO. | SHEET NO. 45 OF 46 | | | | | | | | | | | | | | | | | | | | | | | | | | | | | | |
| | | | | | SIZE A3 | THIS DRAWING CONTAINS INFORMATION THAT IS PROPRIETARY TO MOLEX INCORPORATED AND SHOULD NOT BE USED WITHOUT WRITTEN PERMISSION | | | | | | | | | | | | | | | | | | | | | | | | | | | | | | | |

| | 10 | 9 | 8 | 7 | 6 | 5 | 4 | 3 | 2 | 1 | | | |
|---|----------------------------|---|--------------------------------------|--|---|----------|---------------|--------------|-----------|-------|-------|------|------|
| | PART NO FOR BULK PACKAGING | PART NO. FOR TUBE WITHOUT CAP PACKAGING | PART NO. FOR TUBE WITH CAP PACKAGING | PART NO. FOR TAPE & REEL WITHOUT CAP PACKAGING | PART NO. FOR TAPE & REEL WITH CAP PACKAGING | CKT SIZE | VOID POSITION | PLATING TYPE | DIMENSION | | | | |
| | | | | | | | | | A | B | F | M | P |
| F | 87914-8011 | ----- | ----- | ----- | ----- | 80 | ---- | 1 | 101.60 | 99.06 | 10.92 | 5.84 | 2.79 |
| | 87914-8021 | ----- | ----- | ----- | ----- | 80 | ---- | 1 | 101.60 | 99.06 | 12.25 | 7.00 | 2.96 |
| | 87914-8012 | ----- | ----- | ----- | ----- | 80 | ---- | 2 | 101.60 | 99.06 | 10.92 | 5.84 | 2.79 |
| | 87914-8022 | ----- | ----- | ----- | ----- | 80 | ---- | 2 | 101.60 | 99.06 | 12.25 | 7.00 | 2.96 |
| | 87914-8013 | ----- | ----- | ----- | ----- | 80 | ---- | 3 | 101.60 | 99.06 | 10.92 | 5.84 | 2.79 |
| | 87914-8023 | ----- | ----- | ----- | ----- | 80 | ---- | 3 | 101.60 | 99.06 | 12.25 | 7.00 | 2.96 |
| E | 87914-8014 | ----- | ----- | ----- | ----- | 80 | ---- | 4 | 101.60 | 99.06 | 10.92 | 5.84 | 2.79 |
| | 87914-8024 | ----- | ----- | ----- | ----- | 80 | ---- | 4 | 101.60 | 99.06 | 12.25 | 7.00 | 2.96 |
| | 87914-8015 | ----- | ----- | ----- | ----- | 80 | ---- | 5 | 101.60 | 99.06 | 10.92 | 5.84 | 2.79 |
| | 87914-8025 | ----- | ----- | ----- | ----- | 80 | ---- | 5 | 101.60 | 99.06 | 12.25 | 7.00 | 2.96 |
| | 87914-8016 | ----- | ----- | ----- | ----- | 80 | ---- | 6 | 101.60 | 99.06 | 10.92 | 5.84 | 2.79 |
| | 87914-8026 | ----- | ----- | ----- | ----- | 80 | ---- | 6 | 101.60 | 99.06 | 12.25 | 7.00 | 2.96 |
| D | | | | | | | | | | | | | |
| | | | | | | | | | | | | | |
| | | | | | | | | | | | | | |
| | | | | | | | | | | | | | |
| C | | | | | | | | | | | | | |
| | | | | | | | | | | | | | |
| | | | | | | | | | | | | | |
| | | | | | | | | | | | | | |
| B | | | | | | | | | | | | | |
| | | | | | | | | | | | | | |

| PG8. +879140108 EC NO: S2010-0695 DRWN:ATSEE 2010/02/11 CHKD:PTLIM 2004/12/08 APPR:MLONG 2010/06/05 | QUALITY SYMBOLS $F_A=0$ $F_G=0$ $F_P=0$ | GENERAL TOLERANCES (UNLESS SPECIFIED) <table border="1"> <tr> <th></th> <th>mm</th> <th>INCH</th> </tr> <tr> <td>4 PLACES</td> <td>± ---</td> <td>± ---</td> </tr> <tr> <td>3 PLACES</td> <td>± ---</td> <td>± ---</td> </tr> <tr> <td>2 PLACES</td> <td>± 0.20</td> <td>± ---</td> </tr> <tr> <td>1 PLACE</td> <td>± ---</td> <td>± ---</td> </tr> </table> | | mm | INCH | 4 PLACES | ± --- | ± --- | 3 PLACES | ± --- | ± --- | 2 PLACES | ± 0.20 | ± --- | 1 PLACE | ± --- | ± --- | DIMENSION STYLE MM ONLY | SCALE NTS | DESIGN UNITS METRIC | THIRD ANGLE PROJECTION |
|--|--|---|----------|---|-------|----------|-------|-------|----------|-------|-------|----------|--------|-------|---------|-------|-------|-----------------------------------|--------------|------------------------|------------------------|
| | | | | mm | INCH | | | | | | | | | | | | | | | | |
| | | | 4 PLACES | ± --- | ± --- | | | | | | | | | | | | | | | | |
| | | | 3 PLACES | ± --- | ± --- | | | | | | | | | | | | | | | | |
| | | | 2 PLACES | ± 0.20 | ± --- | | | | | | | | | | | | | | | | |
| 1 PLACE | ± --- | ± --- | | | | | | | | | | | | | | | | | | | |
| DRAWN BY KCHO | DATE 2004/11/05 | TITLE 2.54MM PITCH DUAL ROW HEADER SINGLE WAFER, T/H | | | | | | | | | | | | | | | | | | | |
| CHECKED BY PTLIM | DATE 2004/12/08 | MOLEX INCORPORATED | | | | | | | | | | | | | | | | | | | |
| APPROVED BY SCLOW | DATE 2004/12/10 | DOCUMENT NO. SD-87914-013 | | | | | | | | | | | | | | | | | | | |
| MATERIAL NO. SEE TABLE | | SHEET NO. 46 OF 46 | | | | | | | | | | | | | | | | | | | |
| DRAFT WHERE APPLICABLE MUST REMAIN WITHIN DIMENSIONS | | | | THIS DRAWING CONTAINS INFORMATION THAT IS PROPRIETARY TO MOLEX INCORPORATED AND SHOULD NOT BE USED WITHOUT WRITTEN PERMISSION | | | | | | | | | | | | | | | | | |