

Data Sheet

Description

ASDL-4560 Infrared emitter is a 0805 ChipLED SMT package that is designed for high radiant intensity, fast switching and low forward voltage applications. It is optimized for efficiency at emission wavelength of 875nm and encapsulated with a flat lens for wide viewing angle applications.

Applications

- High-Speed Machine Automated System
- Remote Control
- Smoke Detector
- Medical Applications
- Non-Contact Position Sensing
- Optical Encoders

Features

- 875nm wavelength
- Industry Standard Footprint:
0805 ChipLED SMT Package
- Top Emitting
- High Brightness
- Low Forward Voltage
- High Pulse Rate
- High Speed
- Wide Viewing Angle
- Lead Free and ROHS Compliant
- Tape & Reel for automation placement

Ordering Information

Part Number	Packaging	Shipping Option
ASDL-4650-C22	Tape & Reel	12Kpcs

Package Outline

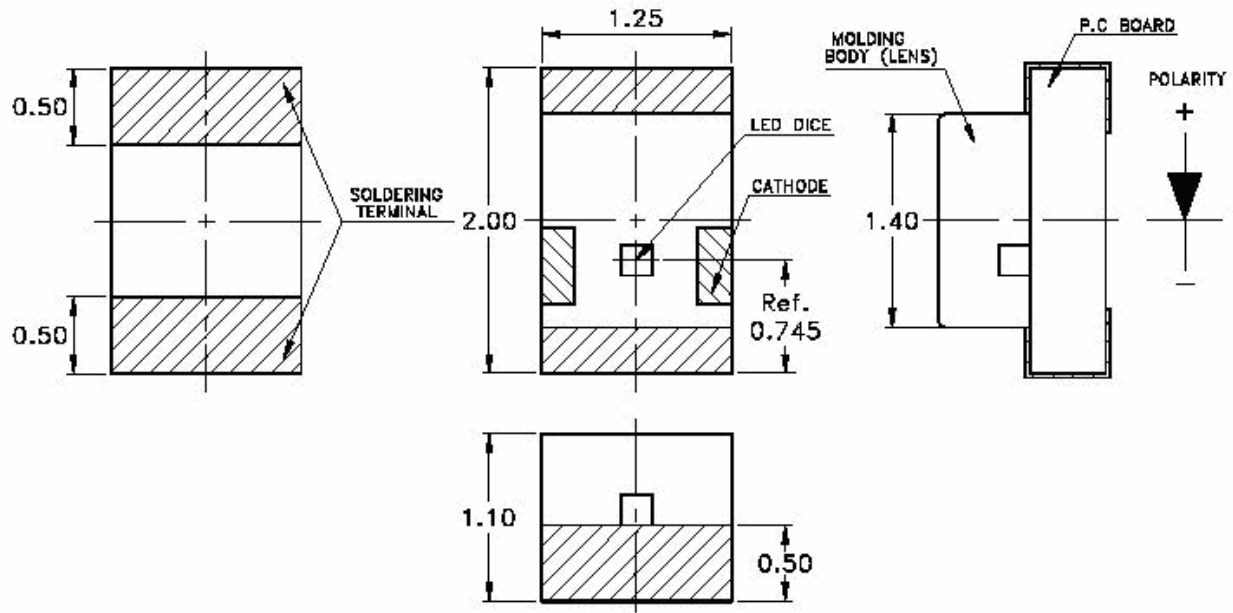

All Dimensions are in Millimeters

Tape and Reel Dimension

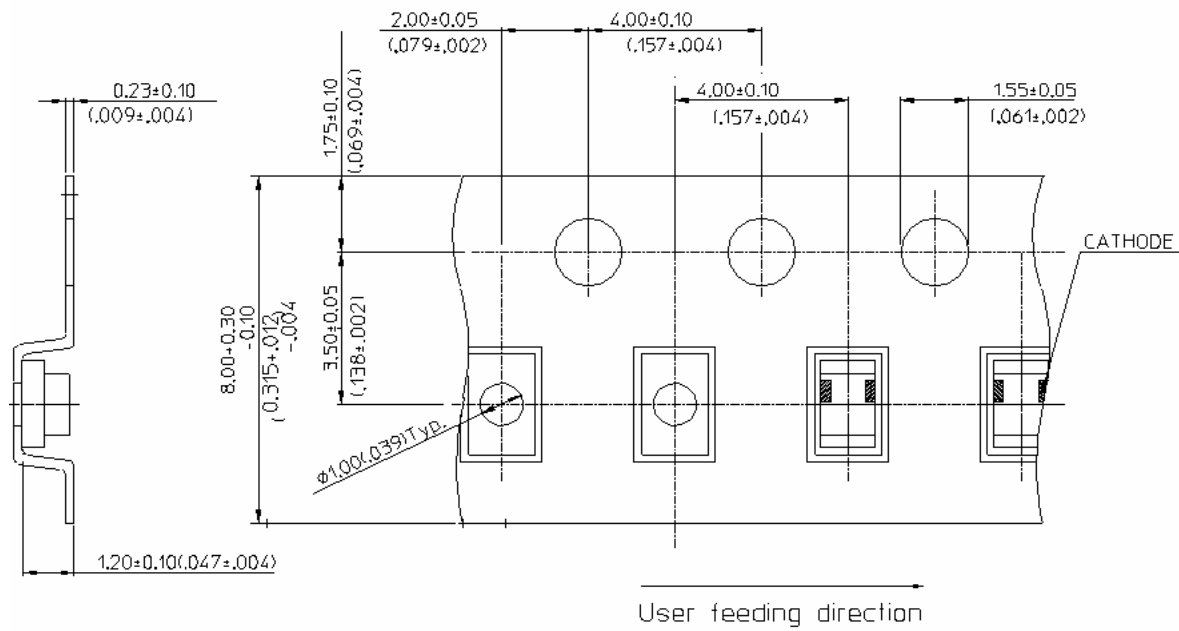

All Dimensions are in Millimeters (Inches)

Absolute Maximum Ratings at 25°C

Parameter	Symbol	Min.	Max	Unit	Reference
Peak Forward Current	I_{FPK}		325	mA	$T_p=500ns$ $T_w=100ns$ Duty Cycle=20%
Continuous Forward Current	I_{FDC}		100	mA	Figure 5
Power Dissipation	P_{DISS}		130	mW	
Reverse Voltage	V_R	4		V	$I_r=10uA$
Operating Temperature	T_O	-40	85	°C	
LED Junction Temperature	T_J		110	°C	
Lead Soldering Temperature			260 for 5 sec	°C	

Electrical Characteristics at 25°C

Parameter	Symbol	Min.	Typ.	Max.	Unit	Condition
Forward Voltage	V_F		1.4	1.75	V	$I_f=20mA$
			1.45	2.0	V	$I_f=50mA$
Reverse Voltage	V_R	4			V	$I_R=10uA$
Thermal Resistance Junction to Ambient			380		°C/W	
Diode Capacitance	C_0		50		pF	$V_f=0V, f=1MHz$

Optical Characteristics at 25°C

Parameter	Symbol	Min.	Typ.	Max.	Unit	Condition
Radiant On-Axis Intensity	I_E	2.0	2.8		mW/Sr	$I_f=50mA$
Viewing Angle	$2\theta_{1/2}$		150		deg	
Peak wavelength	λ_{PK}		875		nm	$I_f=50mA$
Spectral Width	$\Delta\lambda$		45		nm	$I_f=50mA$
Optical Rise Time	t_r		15		ns	$I_{FPK}=500mA$ Duty Factor=20% Pulse Width=100ns
Optical Fall Time	t_f		10		ns	$I_{FPK}=500mA$ Duty Factor=20% Pulse Width=100ns

Typical Electrical / Optical Characteristics Curve ($T_A = 25^\circ\text{C}$ Unless Otherwise Stated)

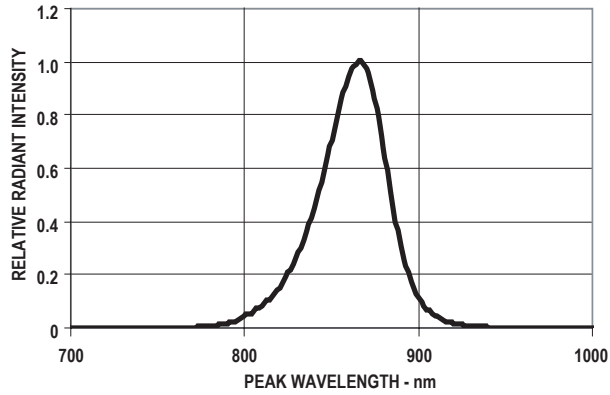

Figure 1. Peak Wavelength Vs Relative Radiant Intensity

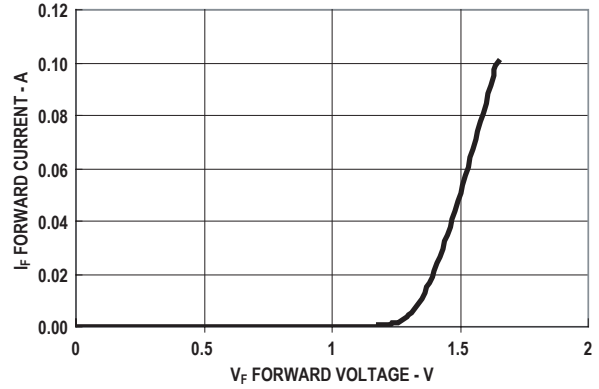

Figure 2. Forward Current Vs Forward Voltage

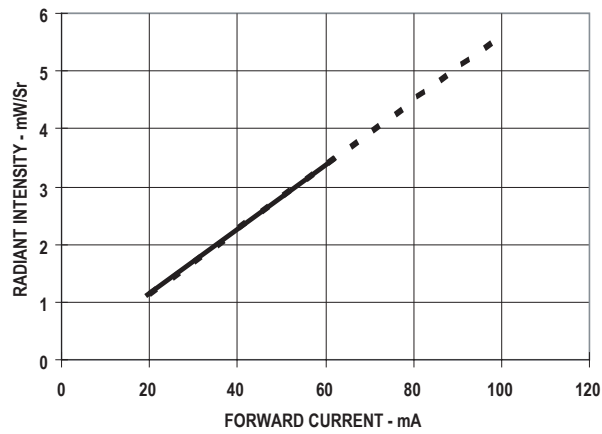

Figure 3. Forward Current Vs Radiant Intensity

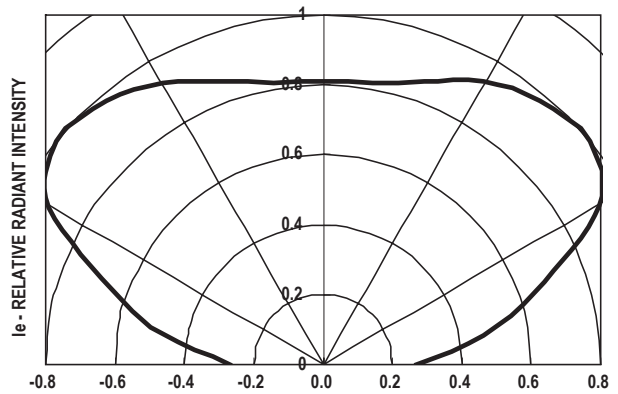

Figure 4. Angular Displacement Vs Relative Radiant Intensity

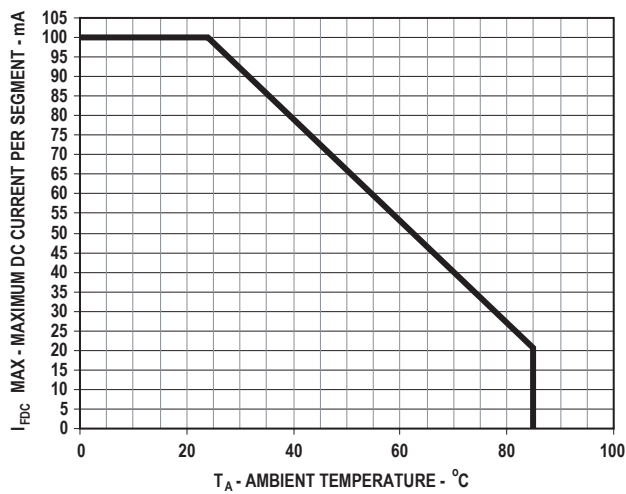
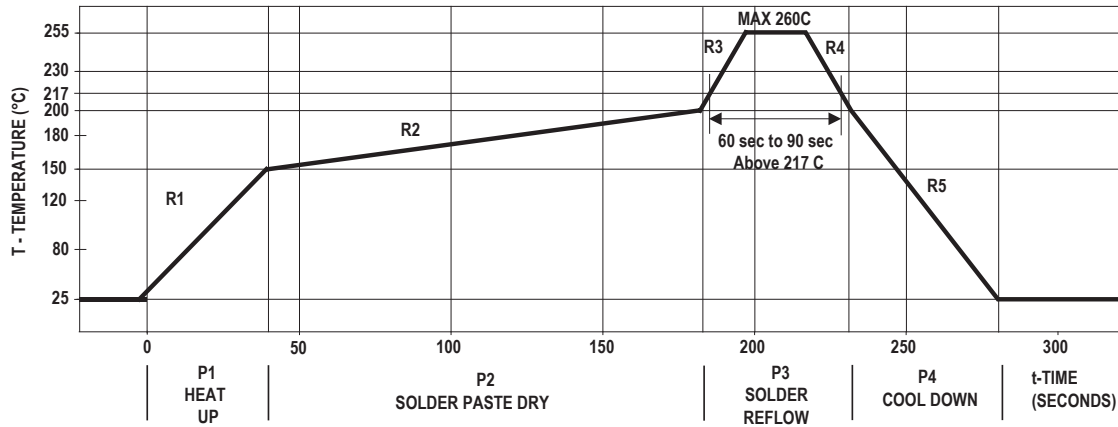

Figure 5. Forward Current versus Ambient Temperature derated based on $T_j = 110^\circ\text{C}$ and thermal resistance at 380°C/W

Recommended Reflow Profile



Process Zone	Symbol	ΔT	Maximum $\Delta T/\Delta \text{time}$ or Duration
Heat Up	P1, R1	25°C to 150°C	3°C/s
Solder Paste Dry	P2, R2	150°C to 200°C	100s to 180s
Solder Reflow	P3, R3 P3, R4	200°C to 260°C 260°C to 200°C	3°C/s -6°C/s
Cool Down	P4, R5	200°C to 25°C	-6°C/s
Time maintained above liquidus point, 217°C		> 217°C	60s to 90s
Peak Temperature		260°C	-
Time within 5°C of actual Peak Temperature		-	20s to 40s
Time 25°C to Peak Temperature		25°C to 260°C	8mins

The reflow profile is a straight-line representation of a nominal temperature profile for a convective reflow solder process. The temperature profile is divided into four process zones, each with different $\Delta T/\Delta \text{time}$ temperature change rates or duration. The $\Delta T/\Delta \text{time}$ rates or duration are detailed in the above table. The temperatures are measured at the component to printed circuit board connections.

In **process zone P1**, the PC board and component pins are heated to a temperature of 150°C to activate the flux in the solder paste. The temperature ramp up rate, R1, is limited to 3°C per second to allow for even heating of both the PC board and component pins.

Process zone P2 should be of sufficient time duration (100 to 180 seconds) to dry the solder paste. The temperature is raised to a level just below the liquidus point of the solder.

Process zone P3 is the solder reflow zone. In zone P3, the temperature is quickly raised above the liquidus point of solder to 260°C (500°F) for optimum results. The dwell time above the liquidus point of solder should be between 60 and 90 seconds. This is to assure proper coalescing of the solder paste into liquid solder and the formation of good solder connections. Beyond the recommended dwell time the intermetallic growth within the solder connections becomes excessive, resulting in the formation of weak and unreliable connections. The temperature is then rapidly reduced to a point below the solidus temperature of the solder to allow the solder within the connections to freeze solid.

Process zone P4 is the cool down after solder freeze. The cool down rate, R5, from the liquidus point of the solder to 25°C (77°F) should not exceed 6°C per second maximum. This limitation is necessary to allow the PC board and component pins to change dimensions evenly, putting minimal stresses on the component.

It is recommended to perform reflow soldering no more than twice.

Recommended Land Pattern

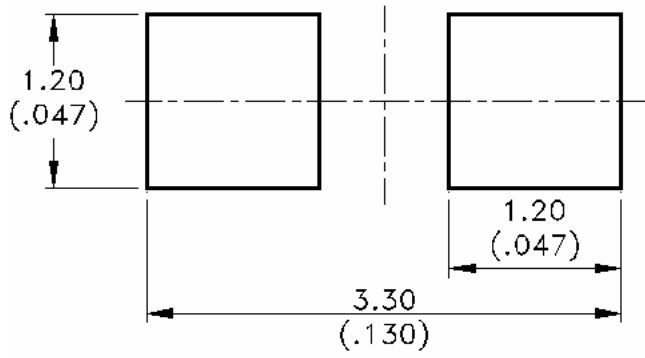

All Dimensions are in Millimeters (Inches)

For product information and a complete list of distributors, please go to our web site: www.avagotech.com

Avago, Avago Technologies, and the A logo are trademarks of Avago Technologies, Limited in the United States and other countries. Data subject to change. Copyright © 2007 Avago Technologies Limited. All rights reserved.
AV02-0275EN - August 24, 2007