

ACZRV5223B-HF Thru. ACZRV5256B-HF

Voltage: 2.7 to 30 Volts

Power: 200 mWatts

RoHS Device

Halogen Free



Features

- For surface mounted applications.
- General purpose, medium current.
- Ideally suited for automated assembly processes.
- Comply with AEC-Q101

Mechanical data

- Case: SOD-323, Molded plastic.
- Terminals: Solder Plated, solderable per MIL-STD-750, method 2026.
- Polarity: Cathode band.
- Weight: 0.004 grams(approx.).

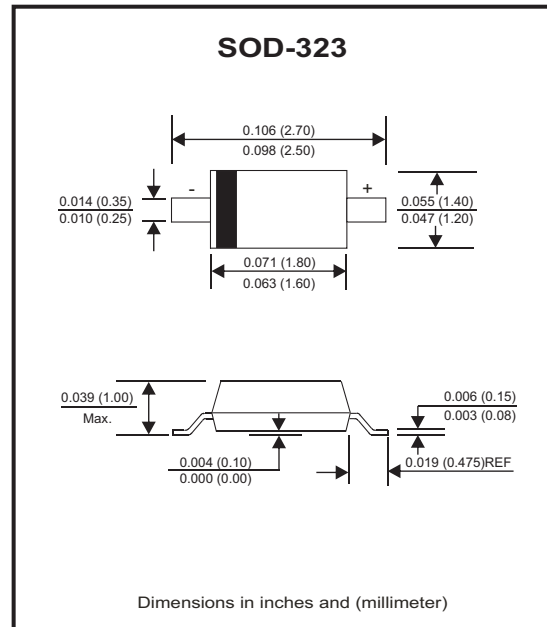

Circuit diagram



Maximum Rating AND Electrical Characteristics

Parameter	Symbol	Value	Unit
Forward voltage (Note 2) @ I _F = 10mA	V _F	0.9	V
Power dissipation (Note 1)	P _d	200	mW
Thermal resistance, junction to ambient air	R _{θJA}	625	°C/W
Junction temperature range	T _j	150	°C
Storage temperature range	T _{STG}	-65 to +150	°C

Notes:

1. Device mounted on ceramic PCBS; 7.6mm x 9.4mm x 0.87mm with pad areas 25mm² .
2. Tested with pulses, T_p ≤ 1.0ms.

Electrical Characteristics (@Ta = 25°C unless otherwise specified)

Part Number	Zener Voltage Range (Note 2)			Maximum Zener Impedance (Note 4)			Maximum Reverse current		Marking Code	
	Vz(V)@IzT			IzT	ZzT@IzT	ZzK@IzK	IzK	IR		VR
	Min(V)	Nom(V)	Max(V)	mA	Ω		mA	uA		V
ACZRV5223B-HF	2.57	2.7	2.84	20	30	1300	0.25	75	1.0	C3
ACZRV5225B-HF	2.85	3.0	3.15	20	30	1600	0.25	50	1.0	C5
ACZRV5226B-HF	3.14	3.3	3.47	20	28	1600	0.25	25	1.0	G1
ACZRV5227B-HF	3.42	3.6	3.78	20	24	1700	0.25	15	1.0	G2
ACZRV5228B-HF	3.71	3.9	4.10	20	23	1900	0.25	10	1.0	G3
ACZRV5229B-HF	4.09	4.3	4.52	20	22	2000	0.25	5.0	1.0	G4
ACZRV5230B-HF	4.47	4.7	4.94	20	19	1900	0.25	5.0	2.0	G5
ACZRV5231B-HF	4.85	5.1	5.36	20	17	1600	0.25	5.0	2.0	E1
ACZRV5232B-HF	5.32	5.6	5.88	20	11	1600	0.25	5.0	3.0	E2
ACZRV5233B-HF	5.70	6.0	6.30	20	7	1600	0.25	5.0	3.5	E3
ACZRV5234B-HF	5.89	6.2	6.51	20	7	1000	0.25	5.0	4.0	E4
ACZRV5235B-HF	6.46	6.8	7.14	20	5	750	0.25	3.0	5.0	E5
ACZRV5236B-HF	7.13	7.5	7.88	20	6	500	0.25	3.0	6.0	F1
ACZRV5237B-HF	7.79	8.2	8.61	20	8	500	0.25	3.0	6.5	F2
ACZRV5238B-HF	8.27	8.7	9.14	20	8	600	0.25	3.0	6.5	F3
ACZRV5239B-HF	8.65	9.1	9.56	20	10	600	0.25	3.0	7.0	F4
ACZRV5240B-HF	9.50	10	10.50	20	17	600	0.25	3.0	8.0	F5
ACZRV5241B-HF	10.45	11	11.55	20	22	600	0.25	2.0	8.4	H1
ACZRV5242B-HF	11.40	12	12.60	20	30	600	0.25	1.0	9.1	H2
ACZRV5243B-HF	12.35	13	13.65	9.5	13	600	0.25	0.5	9.9	H3
ACZRV5244B-HF	13.30	14	14.70	9.0	15	600	0.25	0.1	10	H4
ACZRV5245B-HF	14.25	15	15.75	8.5	16	600	0.25	0.1	11	H5
ACZRV5246B-HF	15.20	16	16.80	7.8	17	600	0.25	0.1	12	J1
ACZRV5248B-HF	17.10	18	18.90	7.0	21	600	0.25	0.1	14	J3
ACZRV5250B-HF	19.00	20	21.00	6.2	25	600	0.25	0.1	15	J5
ACZRV5251B-HF	20.90	22	23.10	5.6	29	600	0.25	0.1	17	K1
ACZRV5252B-HF	22.80	24	25.20	5.2	33	600	0.25	0.1	18	K2
ACZRV5253B-HF	23.75	25	26.25	5.0	35	600	0.25	0.1	19	K3
ACZRV5254B-HF	25.65	27	28.35	5.0	41	600	0.25	0.1	21	K4
ACZRV5255B-HF	26.60	28	29.40	4.5	44	600	0.25	0.1	21	K5
ACZRV5256B-HF	28.50	30	31.50	4.2	49	600	0.25	0.1	23	M1

RATING AND CHARACTERISTIC CURVES (ACZRV52XXB Series)

Fig.1 - Zener Characteristics (V_z up to 10V)

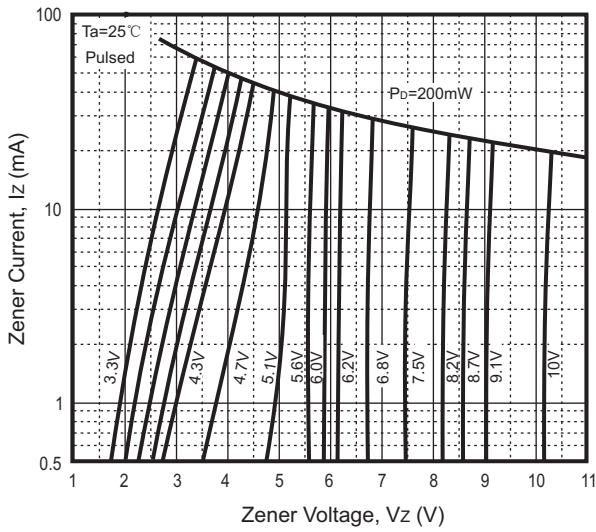

Fig.2 - Zener Characteristics (11V to 39V)

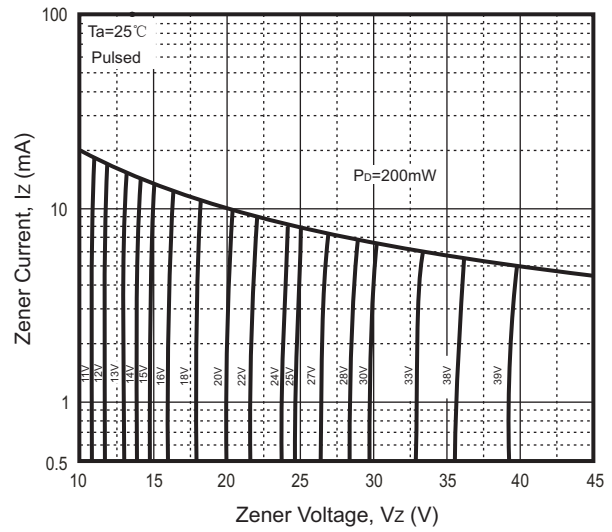

Fig.3 - Temperature Coefficients

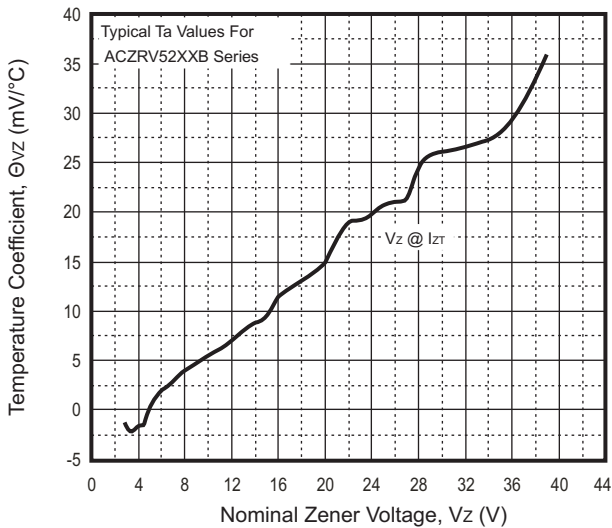

Fig.4 - Typical Capacitance

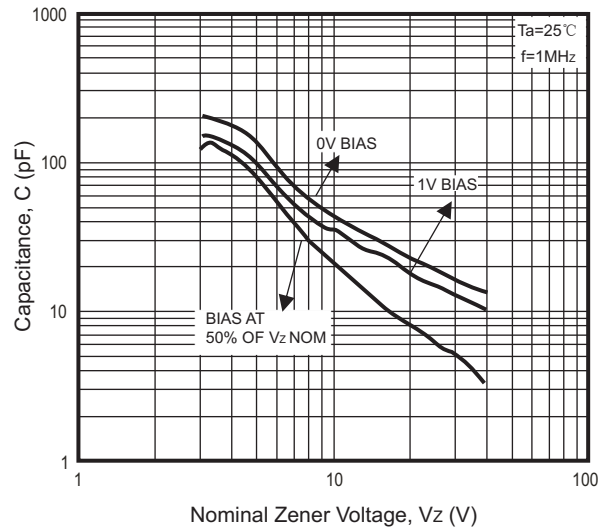

Fig.5 - Effect of Zener Voltage on Zener Impedance

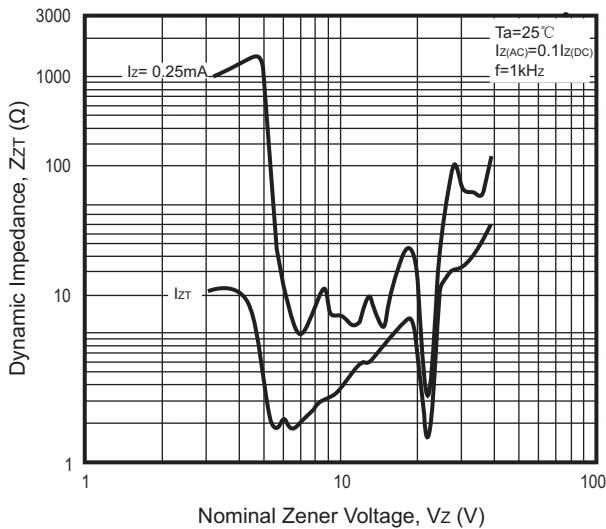
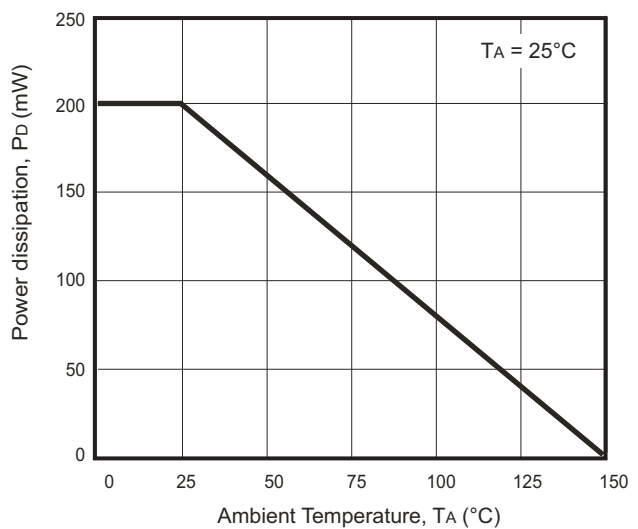
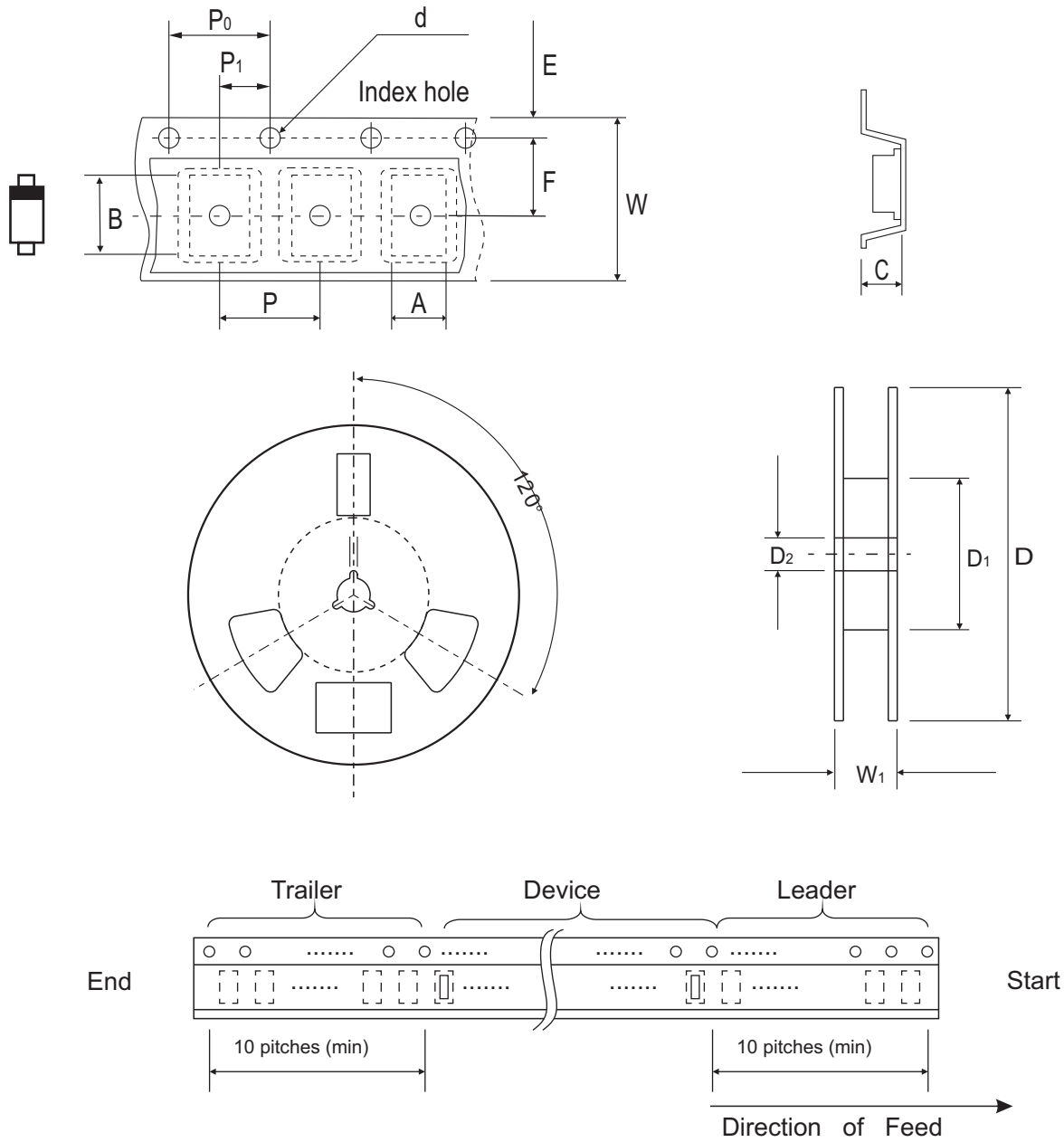

Fig.6- Power Derating Curve



Reel Taping Specification



SOD-323	SYMBOL	A	B	C	d	D	D1	D2
	(mm)	1.46 ± 0.10	2.90 ± 0.10	1.25 ± 0.10	1.50 + 0.10	178 ± 2.00	54.40 ± 1.00	13.00 ± 1.00
	(inch)	0.057 ± 0.004	0.114 ± 0.004	0.049 ± 0.004	0.059 + 0.004	7.008 ± 0.079	2.142 ± 0.039	0.512 ± 0.039

SOD-323	SYMBOL	E	F	P	P0	P1	W	W1
	(mm)	1.75 ± 0.10	3.50 ± 0.10	4.00 ± 0.10	4.00 ± 0.10	2.00 ± 0.10	8.00 + 0.30 / - 0.10	12.30 ± 1.00
	(inch)	0.069 ± 0.004	0.138 ± 0.004	0.158 ± 0.004	0.158 ± 0.004	0.079 ± 0.004	0.315 + 0.012 / - 0.004	0.484 ± 0.039

Marking Code

Part Number	Marking Code
ACZRV5223B-HF ~ ACZRV5256B-HF	XX



Notes:

Product type marking code (see page.2)

- █ = Cathode band
- XX = Product type marking code
- = Halogen Free Parts

Suggested PAD Layout

SIZE	SOD-323	
	(mm)	(inch)
A	2.15	0.085
B	0.80	0.031
C	0.70	0.028
D	2.95	0.116
E	1.35	0.053

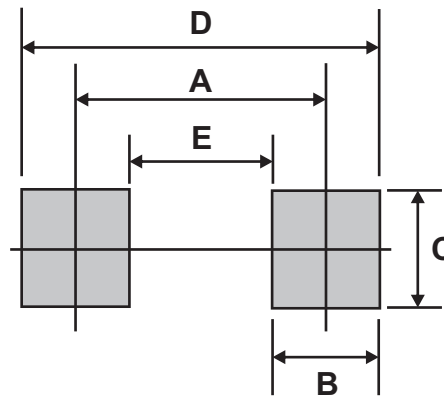

Standard Packaging

Case Type	REEL PACK	
	REEL (pcs)	Reel Size (inch)
SOD-323	3,000	7