



### Power MOSFET

PRODUCT SUMMARY	
$V_{DS}$ (V)	- 100
$R_{DS(on)}$ ( $\Omega$ )	$V_{GS} = - 10$ V   0.60
$Q_g$ (Max.) (nC)	18
$Q_{gs}$ (nC)	3.0
$Q_{gd}$ (nC)	9.0
Configuration	Single

DPAK (TO-252)



IPAK (TO-251)

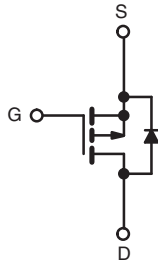
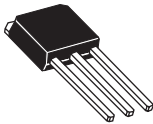

P-Channel MOSFET

#### FEATURES

- Dynamic dV/dt Rating
- Repetitive Avalanche Rated
- Surface Mount (IRFR9120/SiHFR9120)
- Straight Lead (IRFU9120/SiHFU9120)
- Available in Tape and Reel
- P-Channel
- Fast Switching
- Lead (Pb)-free Available



#### DESCRIPTION

Third generation Power MOSFETs from Vishay provide the designer with the best combination of fast switching, ruggedized device design, low on-resistance and cost-effectiveness.

The DPAK is designed for surface mounting using vapor phase, infrared, or wave soldering techniques. The straight lead version (IRFU/SiHFU series) is for through-hole mounting applications. Power dissipation levels up to 1.5 W are possible in typical surface mount applications.

ORDERING INFORMATION				
Package	DPAK (TO-252)	DPAK (TO-252)	DPAK (TO-252)	IPAK (TO-251)
Lead (Pb)-free	IRFR9120PbF	IRFR9120TRPbF <sup>a</sup>	IRFR9120TRLPbF <sup>a</sup>	IRFU9120PbF
	SiHFR9120-E3	SiHFR9120T-E3 <sup>a</sup>	SiHFR9120TL-E3 <sup>a</sup>	SiHFU9120-E3
SnPb	IRFR9120	IRFR9120TR <sup>a</sup>	IRFR9120TRL <sup>a</sup>	IRFU9120PbF
	SiHFR9120	SiHFR9120T <sup>a</sup>	SiHFR9120TL <sup>a</sup>	SiHFU9120

**Note**

a. See device orientation.

ABSOLUTE MAXIMUM RATINGS $T_C = 25$ °C, unless otherwise noted				
PARAMETER	SYMBOL		LIMIT	UNIT
Drain-Source Voltage	$V_{DS}$		- 100	V
Gate-Source Voltage	$V_{GS}$		$\pm 20$	
Continuous Drain Current	$V_{GS}$ at - 10 V	$T_C = 25$ °C	- 5.6	A
		$T_C = 100$ °C	- 3.6	
Pulsed Drain Current <sup>a</sup>	$I_{DM}$		- 22	W/°C
Linear Derating Factor			0.33	
Linear Derating Factor (PCB Mount) <sup>e</sup>			0.020	
Single Pulse Avalanche Energy <sup>b</sup>	$E_{AS}$		210	mJ
Repetitive Avalanche Current <sup>a</sup>	$I_{AR}$		- 5.6	A
Repetitive Avalanche Energy <sup>a</sup>	$E_{AR}$		4.2	mJ
Maximum Power Dissipation	$T_C = 25$ °C		42	W
Maximum Power Dissipation (PCB Mount) <sup>e</sup>	$T_A = 25$ °C		2.5	
Peak Diode Recovery dV/dt <sup>c</sup>	$dV/dt$		- 5.5	V/ns

<b>ABSOLUTE MAXIMUM RATINGS</b> $T_C = 25\text{ }^\circ\text{C}$ , unless otherwise noted			
PARAMETER	SYMBOL	LIMIT	UNIT
Operating Junction and Storage Temperature Range	$T_J, T_{stg}$	- 55 to + 150	°C
Soldering Recommendations (Peak Temperature)	for 10 s	260 <sup>d</sup>	

### Notes

- Repetitive rating; pulse width limited by maximum junction temperature (see fig. 11).
- $V_{DD} = -25\text{ V}$ , starting  $T_J = 25\text{ }^\circ\text{C}$ ,  $L = 10\text{ mH}$ ,  $R_G = 25\text{ }\Omega$ ,  $I_{AS} = -5.6\text{ A}$  (see fig. 12).
- $I_{SD} \leq -6.8\text{ A}$ ,  $dI/dt \leq 110\text{ A}/\mu\text{s}$ ,  $V_{DD} \leq V_{DS}$ ,  $T_J \leq 150\text{ }^\circ\text{C}$ .
- 1.6 mm from case.
- When mounted on 1" square PCB (FR-4 or G-10 material).

<b>THERMAL RESISTANCE RATINGS</b>					
PARAMETER	SYMBOL	MIN.	TYP.	MAX.	UNIT
Maximum Junction-to-Ambient	$R_{thJA}$	-	-	110	°C/W
Maximum Junction-to-Ambient (PCB Mount) <sup>a</sup>	$R_{thJA}$	-	-	50	
Maximum Junction-to-Case (Drain)	$R_{thJC}$	-	-	3.0	

### Note

- When mounted on 1" square PCB (FR-4 or G-10 material).

<b>SPECIFICATIONS</b> $T_J = 25\text{ }^\circ\text{C}$ , unless otherwise noted							
PARAMETER	SYMBOL	TEST CONDITIONS		MIN.	TYP.	MAX.	UNIT
<b>Static</b>							
Drain-Source Breakdown Voltage	$V_{DS}$	$V_{GS} = 0\text{ V}$ , $I_D = -250\text{ }\mu\text{A}$		- 100	-	-	V
$V_{DS}$ Temperature Coefficient	$\Delta V_{DS}/T_J$	Reference to $25\text{ }^\circ\text{C}$ , $I_D = -1\text{ mA}$		-	- 0.098	-	V/°C
Gate-Source Threshold Voltage	$V_{GS(th)}$	$V_{DS} = V_{GS}$ , $I_D = -250\text{ }\mu\text{A}$		- 2.0	-	- 4.0	V
Gate-Source Leakage	$I_{GSS}$	$V_{GS} = \pm 20\text{ V}$		-	-	$\pm 100$	nA
Zero Gate Voltage Drain Current	$I_{DSS}$	$V_{DS} = -100\text{ V}$ , $V_{GS} = 0\text{ V}$		-	-	- 100	$\mu\text{A}$
		$V_{DS} = -80\text{ V}$ , $V_{GS} = 0\text{ V}$ , $T_J = 125\text{ }^\circ\text{C}$		-	-	- 500	
Drain-Source On-State Resistance	$R_{DS(on)}$	$V_{GS} = -10\text{ V}$	$I_D = -3.4\text{ A}^b$	-	-	0.60	$\Omega$
Forward Transconductance	$g_{fs}$	$V_{DS} = -50\text{ V}$ , $I_D = -3.4\text{ A}$		1.5	-	-	S
<b>Dynamic</b>							
Input Capacitance	$C_{iss}$	$V_{GS} = 0\text{ V}$ , $V_{DS} = -25\text{ V}$ , $f = 1.0\text{ MHz}$ , see fig. 5		-	390	-	pF
Output Capacitance	$C_{oss}$			-	170	-	
Reverse Transfer Capacitance	$C_{rss}$			-	45	-	
Total Gate Charge	$Q_g$	$V_{GS} = -10\text{ V}$	$I_D = -6.8\text{ A}$ , $V_{DS} = -80\text{ V}$ , see fig. 6 and 13 <sup>b</sup>	-	-	18	nC
Gate-Source Charge	$Q_{gs}$			-	-	3.0	
Gate-Drain Charge	$Q_{gd}$			-	-	9.0	
Turn-On Delay Time	$t_{d(on)}$	$V_{DD} = -50\text{ V}$ , $I_D = -6.8\text{ A}$ , $R_G = 18\text{ }\Omega$ , $R_D = 7.1\text{ }\Omega$ , see fig. 10 <sup>b</sup>		-	9.6	-	ns
Rise Time	$t_r$			-	29	-	
Turn-Off Delay Time	$t_{d(off)}$			-	21	-	
Fall Time	$t_f$			-	25	-	
Internal Drain Inductance	$L_D$	Between lead, 6 mm (0.25") from package and center of die contact		-	4.5	-	nH
Internal Source Inductance	$L_S$			-	7.5	-	

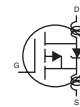



# IRFR9120, IRFU9120, SiHFR9120, SiHFU9120

**KERSEMI**

SPECIFICATIONS $T_J = 25^\circ\text{C}$ , unless otherwise noted							
PARAMETER	SYMBOL	TEST CONDITIONS	MIN.	TYP.	MAX.	UNIT	
<b>Drain-Source Body Diode Characteristics</b>							
Continuous Source-Drain Diode Current	$I_S$	MOSFET symbol showing the integral reverse p - n junction diode 	-	-	- 5.6	A	
Pulsed Diode Forward Current <sup>a</sup>	$I_{SM}$		-	-	- 22		
Body Diode Voltage	$V_{SD}$	$T_J = 25^\circ\text{C}$ , $I_S = -5.6\text{ A}$ , $V_{GS} = 0\text{ V}^b$	-	-	- 6.3	V	
Body Diode Reverse Recovery Time	$t_{rr}$	$T_J = 25^\circ\text{C}$ , $I_F = -6.8\text{ A}$ , $di/dt = 100\text{ A}/\mu\text{s}^b$	-	100	200	ns	
Body Diode Reverse Recovery Charge	$Q_{rr}$		-	0.33	0.66	$\mu\text{C}$	
Forward Turn-On Time	$t_{on}$	Intrinsic turn-on time is negligible (turn-on is dominated by $L_S$ and $L_D$ )					

**Notes**

- a. Repetitive rating; pulse width limited by maximum junction temperature (see fig. 11).
- b. Pulse width  $\leq 300\ \mu\text{s}$ ; duty cycle  $\leq 2\%$ .

**TYPICAL CHARACTERISTICS**  $25^\circ\text{C}$ , unless otherwise noted

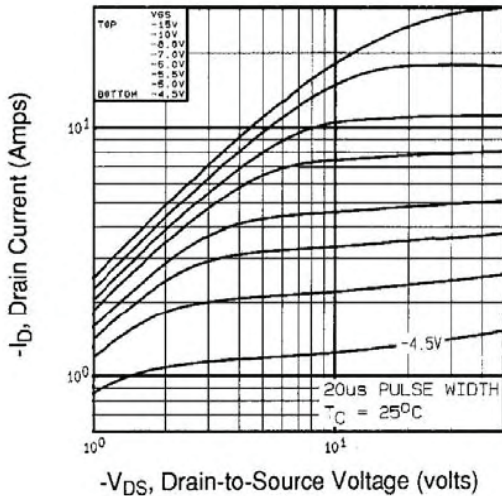

Fig. 1 - Typical Output Characteristics,  $T_C = 25^\circ\text{C}$

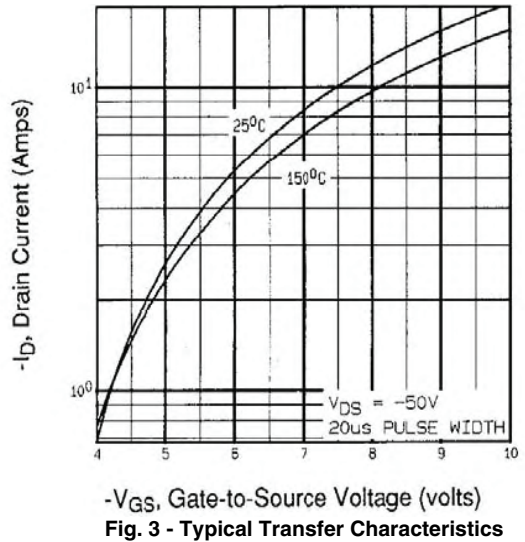

Fig. 3 - Typical Transfer Characteristics

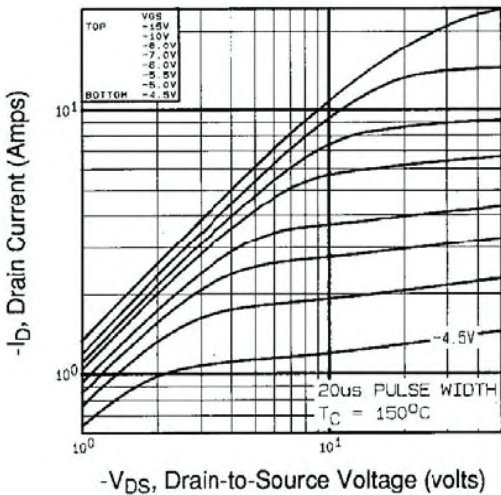

Fig. 2 - Typical Output Characteristics,  $T_C = 150^\circ\text{C}$

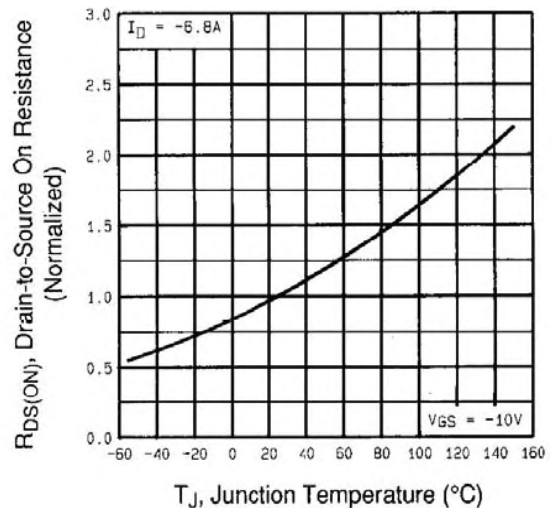

Fig. 4 - Normalized On-Resistance vs. Temperature

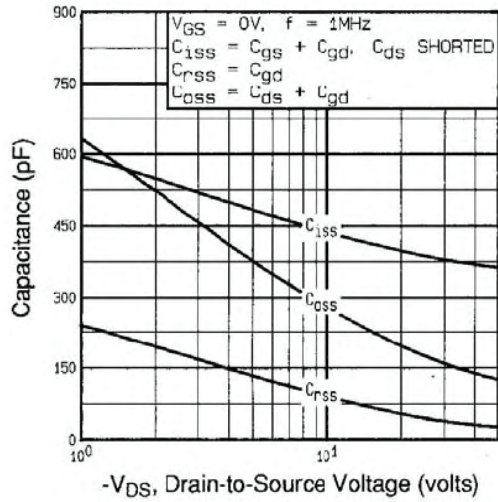

Fig. 5 - Typical Capacitance vs. Drain-to-Source Voltage

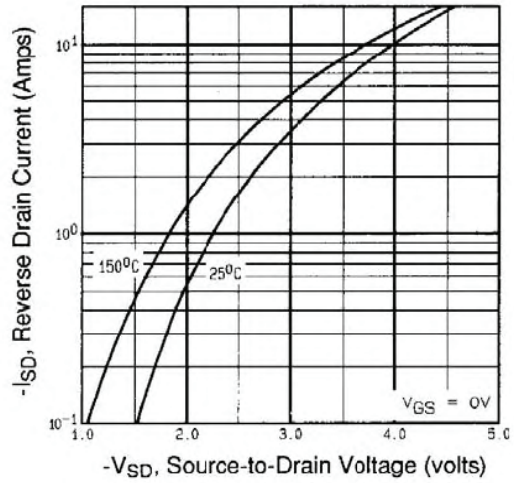

Fig. 7 - Typical Source-Drain Diode Forward Voltage

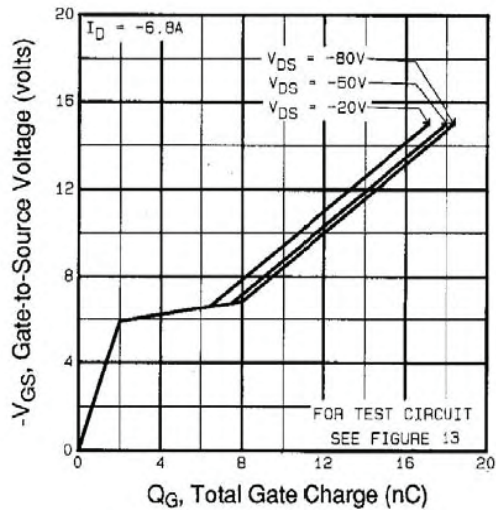

Fig. 6 - Typical Gate Charge vs. Gate-to-Source Voltage

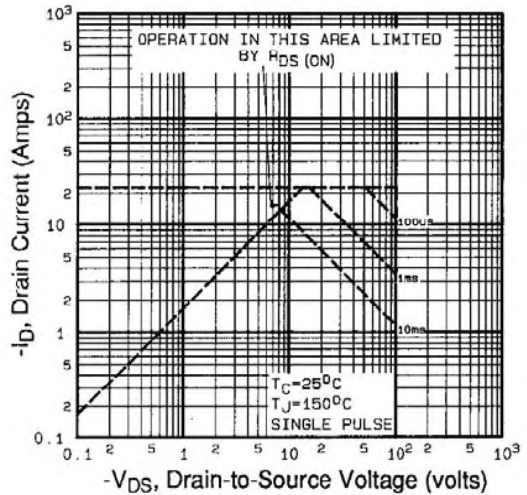

Fig. 8 - Maximum Safe Operating Area

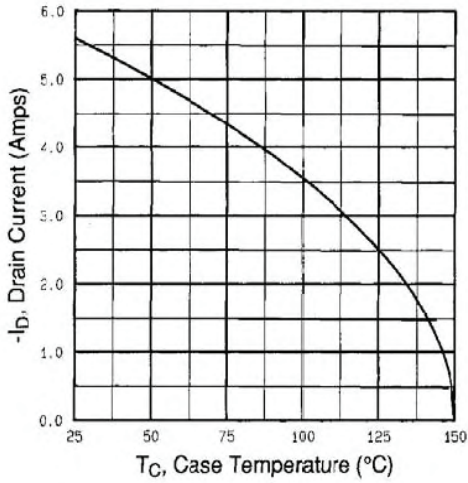

Fig. 9 - Maximum Drain Current vs. Case Temperature

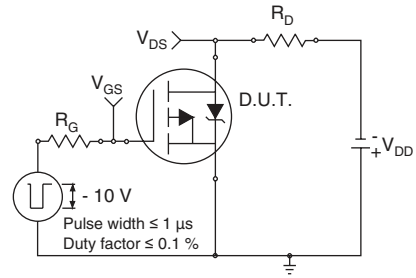

Fig. 10a - Switching Time Test Circuit

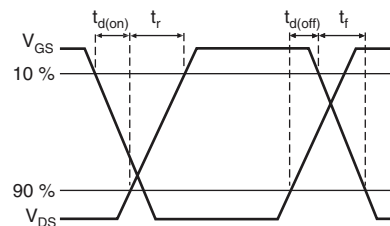

Fig. 10b - Switching Time Waveforms

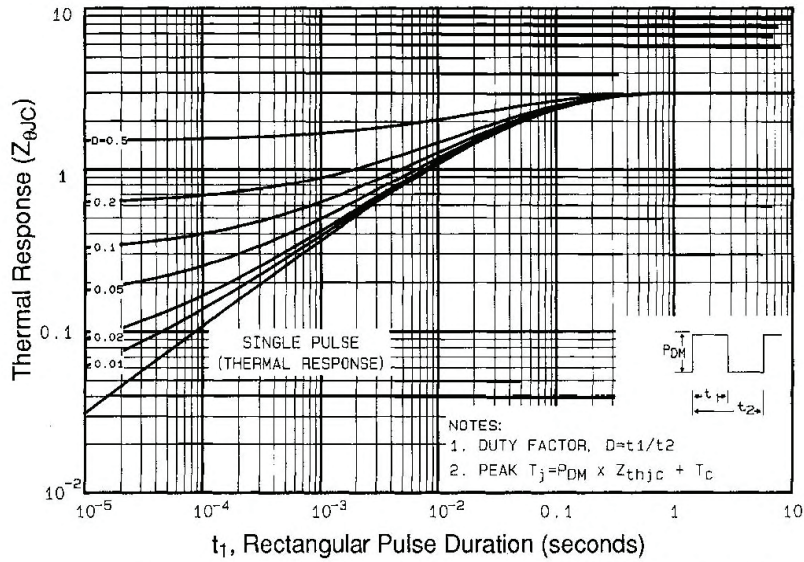

Fig. 11 - Maximum Effective Transient Thermal Impedance, Junction-to-Case

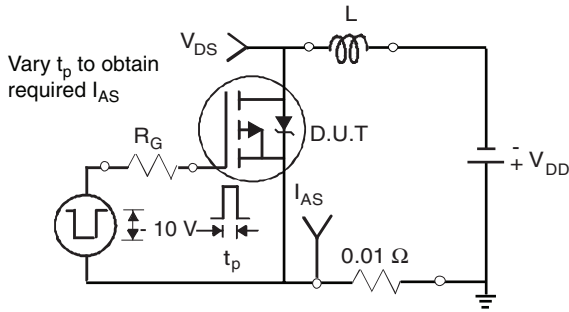

Fig. 12a - Unclamped Inductive Test Circuit

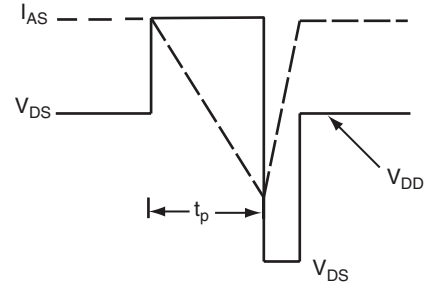

Fig. 12b - Unclamped Inductive Waveforms

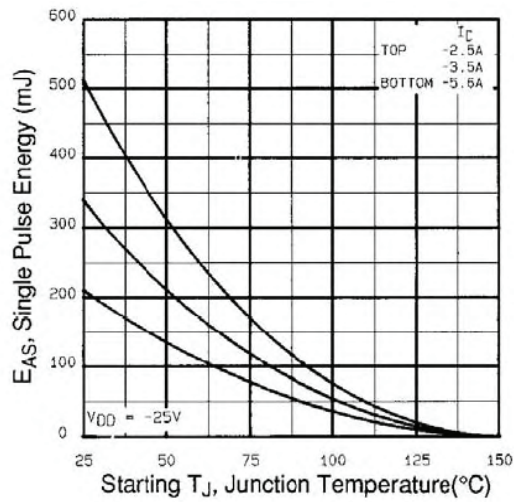

Fig. 12c - Maximum Avalanche Energy vs. Drain Current

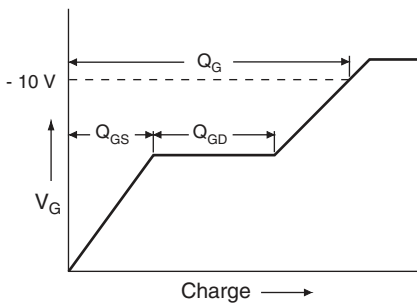

Fig. 13a - Basic Gate Charge Waveform

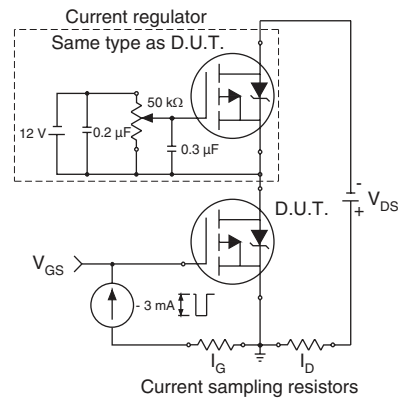

Fig. 13b - Gate Charge Test Circuit



KERSEMI

# IRFR9120, IRFU9120, SiHFR9120, SiHFU9120

## Peak Diode Recovery dV/dt Test Circuit

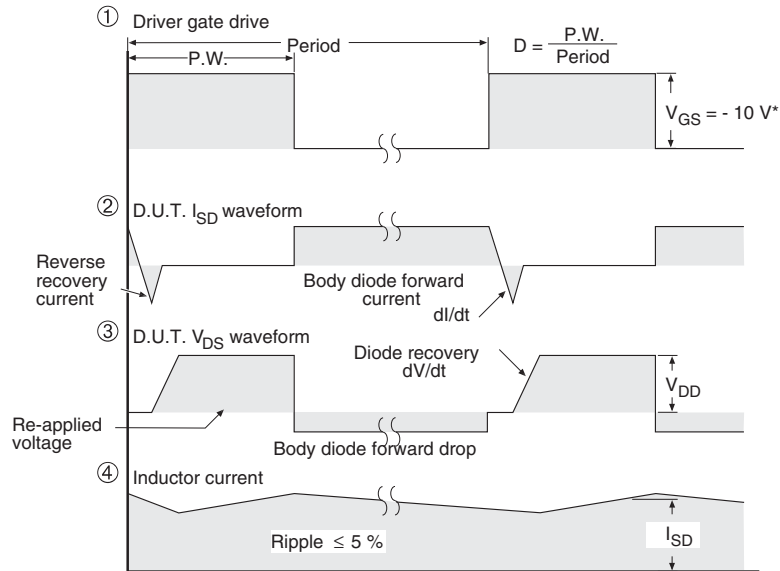
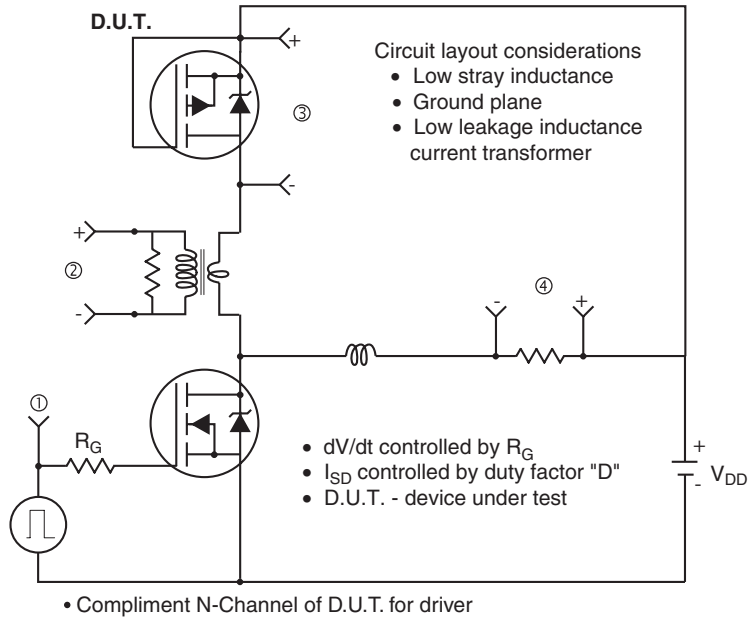

\*  $V_{GS} = -5\text{ V}$  for logic level and  $-3\text{ V}$  drive devices

Fig. 14 - For P-Channel