

Cree® P4 LED CP42B-RKS/AKS Data Sheet

This revolutionary package design allows the lighting designer to reduce the number of LEDs required and provide a more uniform and unique illuminated appearance than with other LED solutions.

This is possible through the efficient optical package design and high current capabilities. The low profile package can be easily coupled with reflectors or lenses to efficiently distribute light and provide the desired lit appearance. This product family employs green and blue LED materials, which allow designers to match the color of many lighting applications like vehicle signal lamps and amusement lighting.



FEATURES

- Size (mm): 7.6 x 7.6
- Color and Typical Dominant Wavelength (nm):
Red (624)
Amber (591)
- Luminous Flux (mlm)
Red (4400 - 11000)
Amber (5500 - 13200)
- Lead-Free
- RoHS Compliant

APPLICATIONS

- Channel Letter
- Amusement



Absolute Maximum Ratings ($T_A = 25^\circ\text{C}$)

Items	Symbol	Absolute Maximum Rating	Unit
		Red/Amber	
Forward Current	I_F	70 ^{Note1}	mA
Peak Forward Current ^{Note2}	I_{FP}	200	mA
Reverse Voltage	V_R	5	V
Power Dissipation	P_D	210	mW
Operation Temperature	T_{opr}	-40 ~ +100	$^\circ\text{C}$
Storage Temperature	T_{stg}	-40 ~ +100	$^\circ\text{C}$
Lead Soldering Temperature	T_{sol}	Max. 260 $^\circ\text{C}$ for 5 sec. max. (3 mm from the base of the epoxy bulb)	
Electrostatic Discharge Classification (MIL-STD-883E)	ESD	Class 2	

Note:

1. A heat sink is recommended if the device is operated at ambient temperatures higher than 25 $^\circ\text{C}$.
2. Pulse width ≤ 0.1 msec, duty $\leq 1/10$.

Typical Electrical & Optical Characteristics ($T_A = 25^\circ\text{C}$)

Characteristics	Color	Symbol	Condition	Unit	Minimum	Typical	Maximum
Forward Voltage	Red/Amber	V_F	$I_F = 70$ mA	V		2.5	3.0
Reverse Current	Red/Amber	I_R	$V_R = 5$ V	μA			100
Dominant Wavelength	Red	λ_D	$I_F = 70$ mA	nm	618	624	630
	Amber	λ_D	$I_F = 70$ mA	nm	584	591	599
Luminous Flux	Red	Φ_v	$I_F = 70$ mA	mlm	4400	6000	
	Amber	Φ_v	$I_F = 70$ mA	mlm	5500	7000	
50% Power Angle	Red/Amber	$2\theta_{1/2}$	$I_F = 70$ mA	deg		120	



Flux Bin Limit ($I_F = 70 \text{ mA}$)

Red

Bin Code	Min.(mlm)	Max.(mlm)
L0	4400	5500
M0	5500	6600
N0	6600	8730
P0	8730	11000

Amber

Bin Code	Min.(mlm)	Max.(mlm)
M0	5500	6600
N0	6600	8730
P0	8730	11000
Q0	11000	13200

- Tolerance of measurement of luminous flux is $\pm 15\%$

Color Bin Limit ($I_F = 70 \text{ mA}$)

Red

Bin Code	Min.(nm)	Max.(nm)
RA	618	630

Amber

Bin Code	Min.(nm)	Max.(nm)
A2	584	587
A3	587	590
A4	590	593
A5	593	596
A6	596	599

- Tolerance of measurement of dominant wavelength is $\pm 1 \text{ nm}$

VF Bin Limit ($I_F = 70 \text{ mA}$)

Red

Bin Code	Min.(V)	Max.(V)
23	2.0	2.2
24	2.2	2.4
25	2.4	2.6
26	2.6	2.8
27	2.8	3.0

Amber

Bin Code	Min.(V)	Max.(V)
23	2.0	2.2
24	2.2	2.4
25	2.4	2.6
26	2.6	2.8
27	2.8	3.0

- Tolerance of measurement of VF is $\pm 0.05\text{V}$

Graphs

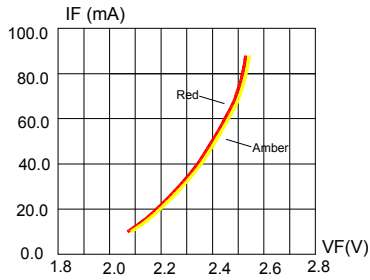

FIG. 1 FORWARD CURRENT VS. FORWARD VOLTAGE.

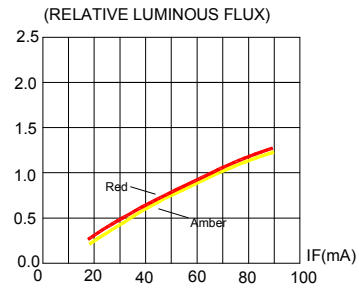

FIG. 2 RELATIVE LUMINOUS FLUX VS. FORWARD CURRENT

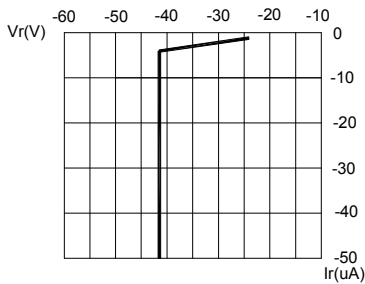

FIG. 3 Red & Amber REVERSE CURRENT VS. REVERSE VOLTAGE.

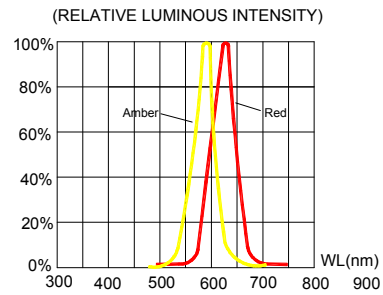

FIG. 4 RELATIVE LUMINOUS INTENSITY VS. WAVELENGTH.

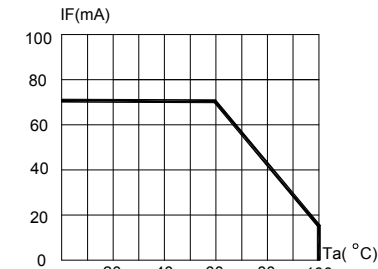

FIG. 5 Red & Amber MAXIMUM FORWARD DC CURRENT VS AMBIENT TEMPERATURE (Tjmax=120°C)

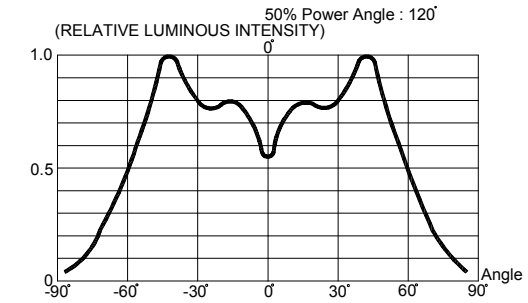

FIG. 6 FAR FIELD PATTERN

The above data are collected from statistical figures that do not necessarily correspond to the actual parameters of each single LED. Hence, these data will be changed without further notice.



Mechanical Dimensions

All dimensions are in mm. Tolerance is ± 0.25 mm unless otherwise noted.

An epoxy meniscus may extend about 1.5 mm down the leads.

Burr around bottom of epoxy may be 0.5 mm max.

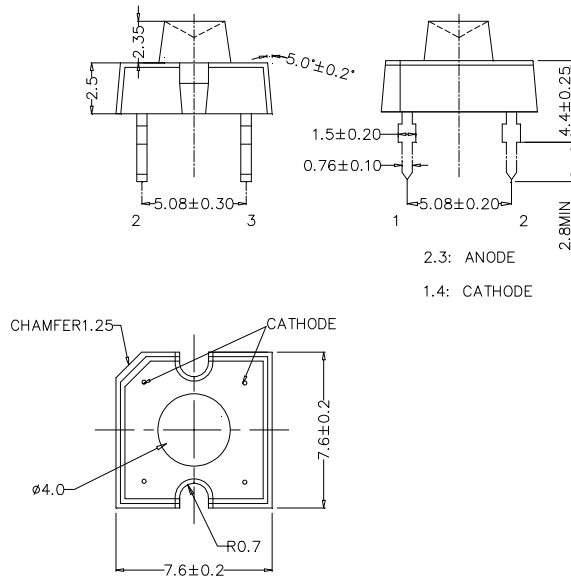

Notes

RoHS Compliance

The levels of environmentally sensitive, persistent biologically toxic (PBT), persistent organic pollutants (POP), or otherwise restricted materials in this product are below the maximum concentration values (also referred to as the threshold limits) permitted for such substances, or are used in an exempted application, in accordance with EU Directive 2002/95/EC on the restriction of the use of certain hazardous substances in electrical and electronic equipment (RoHS), as amended through April 21, 2006.

Vision Advisory Claim

Users should be cautioned not to stare at the light of this LED product. The bright light can damage the eye.

Package

Features:

- The LEDs are packed in cardboard boxes after packaging in normal or anti-electrostatic bags.
- Cardboard boxes will be used to protect the LEDs from mechanical shock during transportation.
- The boxes are not water resistant, and they must be kept away from water and moisture.
- The Tube Pack type of packaging.
- Max 60 pcs per tube.

