

Features

- For WLAN applications
- Usable bandwidth of 17 MHz
- Low loss
- High attenuation
- Balanced operation
- Ceramic Surface Mount Package (SMP)
- Hermetic
- RoHS compliant (2002/95/EC), Pb-free 

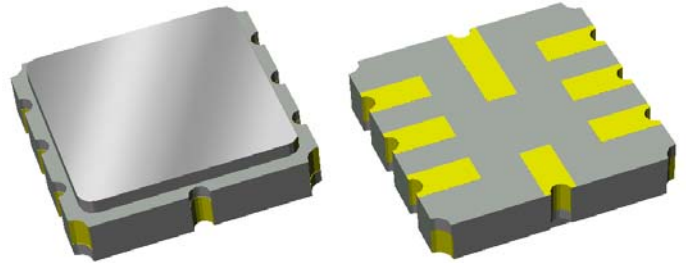

Package

Surface Mount 5.00 x 5.00 x 1.32 mm
SMP-20

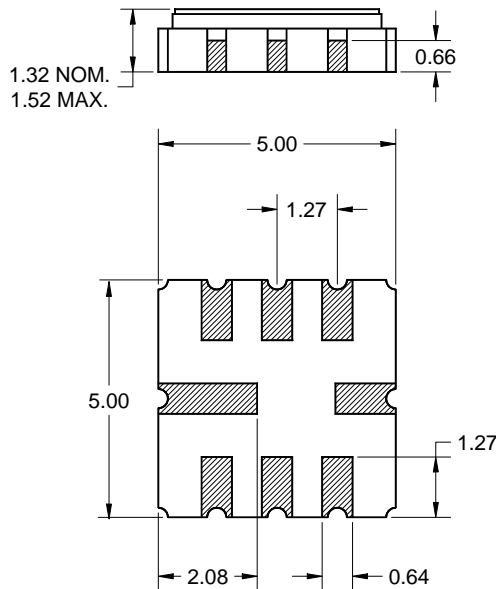

Dimensions shown are nominal in millimeters
All tolerances are ± 0.15 mm except overall
length and width $+0.15/-0.10$ mm

Body: Al_2O_3 ceramic
Lid: Kovar, Ni plated
Terminations: Au plating 0.5 - 1.0 μ m,
over a 2 - 6 μ m Ni plating

Pin Configuration

Bottom View

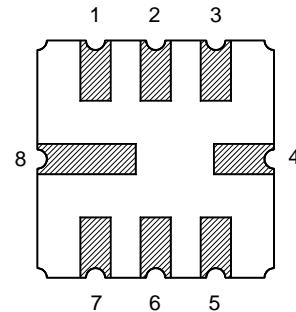

Pin No.	Description
1,3	Balanced Input
5,7	Balanced Output
2,6	External ground
8,4	Case ground

Electrical Specifications ⁽¹⁾

Operating Temperature Range: ⁽²⁾ -10 to +70 °C

Parameter ⁽³⁾	Minimum	Typical ⁽⁴⁾	Maximum	Unit
Center Frequency	-	770	-	MHz
Minimum Insertion Loss	-	2.3	3.2	dB
Maximum Insertion Loss 761.5 - 778.5 MHz	-	4.74	6.2	dB
Amplitude Variation 761.5 - 778.5 MHz	-	1.876	3.5	dB p-p
Group Delay 761.5-778.5 MHz	-	50	60	nsec
Group Delay Ripple 761.5-778.5 MHz	-	23	100	nsec
Relative Attenuation ⁽⁵⁾				
740 MHz	40	47	-	dB
750 MHz	32.5	45	-	dB
790 MHz	13	31	-	dB
800 MHz	35	51	-	dB
Minimum Rejection ⁽⁵⁾				
1 - 370 MHz	30	46	-	dB
370 - 740 MHz	30	46.5	-	dB
800 - 1400 MHz	30	43.5	-	dB
1400 - 2000 MHz	30	37.75	-	dB
Source Impedance: (Balanced) ⁽⁶⁾	-	250	-	Ω
Load Impedance: (Balanced) ⁽⁶⁾	-	250	-	Ω

Notes:

1. All specifications are based on the TriQuint test circuit matching schematics shown below
2. In production, devices will be tested at room temperature to a guardbanded specification to ensure electrical compliance over temperature
3. Electrical margin has been built into the design to account for the variations due to temperature drift and manufacturing tolerances
4. Typical values are based on average measurements at room temperature
5. Referenced to insertion loss at 770 MHz
6. This is the optimum impedance in order to achieve the performance shown

Test Circuit:

Actual matching values may vary due to PCB layout and parasitics

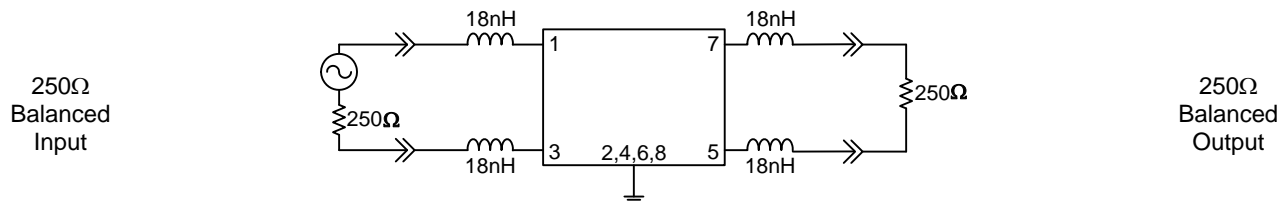

Typical Performance (at +25°C)

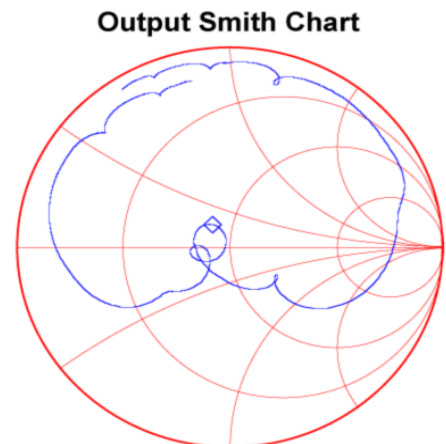
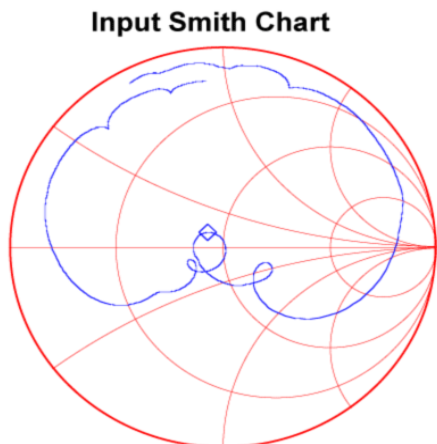
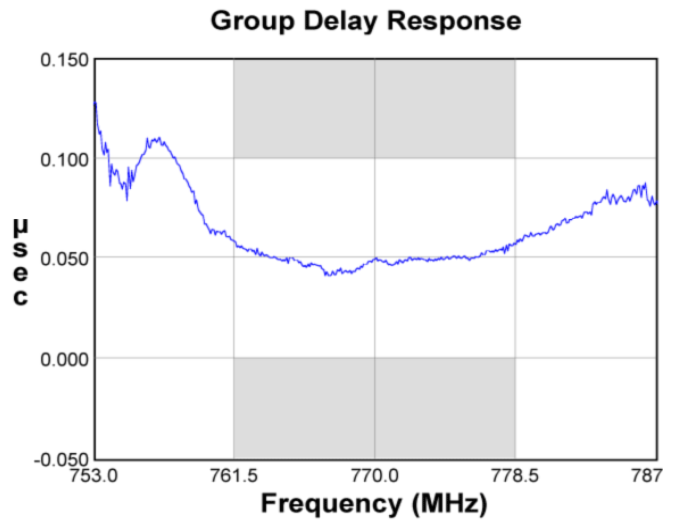
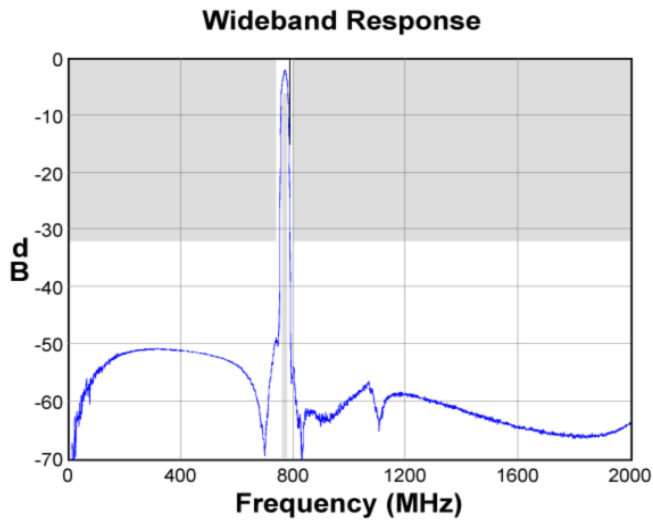
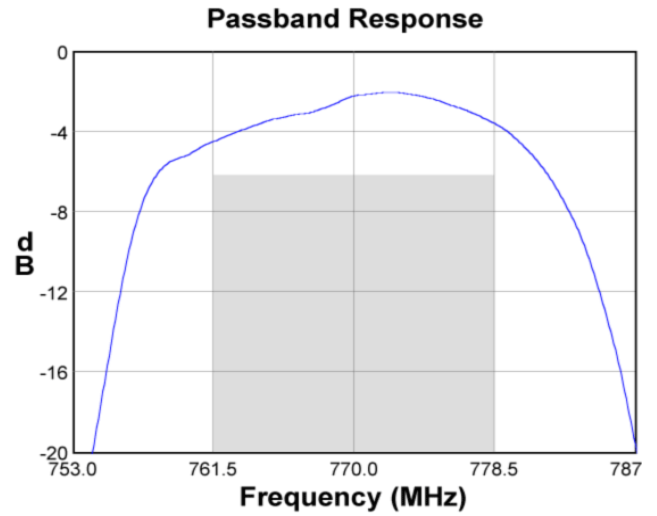
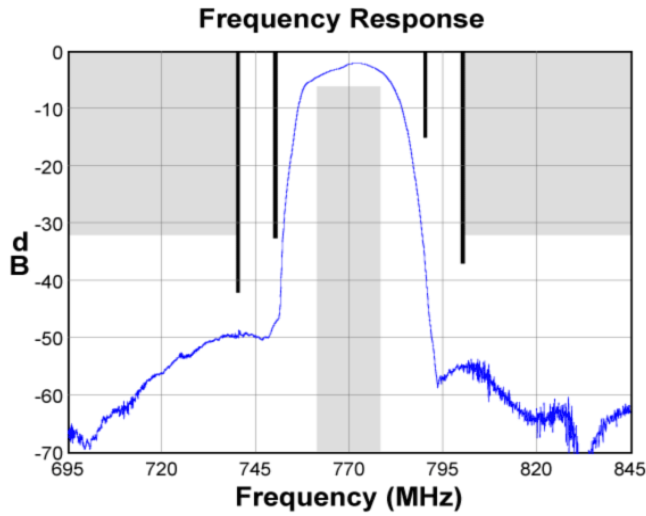

Matching Schematics

Actual matching values may vary due to PCB layout and parasitics

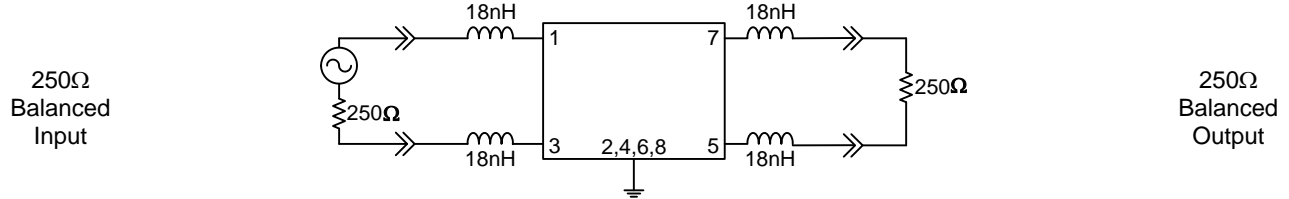

Marking

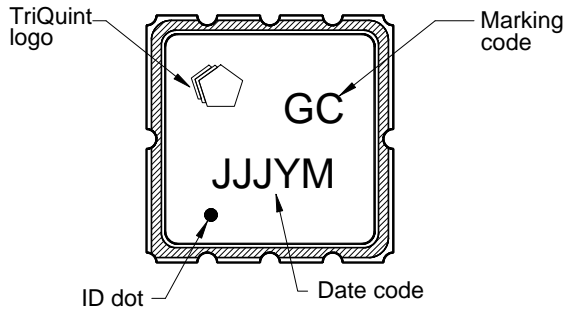

The date code consists of: JJJ = Julian day,
Y = last digit of year, M = manufacturing site code

PCB Footprint

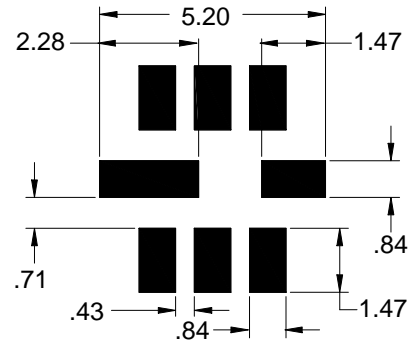

This footprint represents a recommendation only
Dimensions shown are nominal in millimeters

Tape and Reel

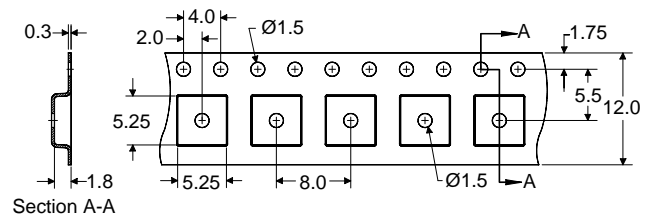
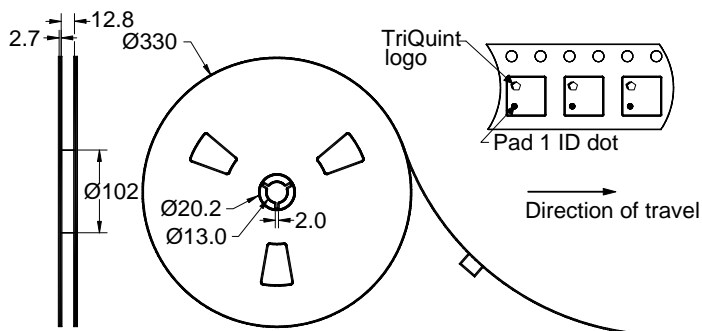

Dimensions shown are nominal in millimeters
Packaging quantity: 4000 units/reel

Maximum Ratings

Parameter	Symbol	Minimum	Maximum	Unit
Operating Temperature Range	T	-10	+70	°C
Storage Temperature Range	T _{stg}	-40	+85	°C

Important Notes

Warnings

- Electrostatic Sensitive Device (ESD) 
- Avoid ultrasonic exposure

RoHS Compliance

- This product complies with EU directive 2002/95/EC (RoHS) 

Solderability

- Compatible with JEDEC J-STD-020C **Pb**-free process, **260°C** peak reflow temperature ([see soldering profile](#))

Links to Additional Technical Information

[PCB Layout Tips](#)

[Qualification Flowchart](#)

[Soldering Profile](#)

[S-Parameters](#)

[RoHS information](#)

[Other Technical Information](#)

TriQuint's liability is limited only to the Surface Acoustic Wave (SAW) component(s) described in this data sheet. TriQuint does not accept any liability for applications, processes, circuits or assemblies, which are implemented using any TriQuint component described in this data sheet.

Contact Information



PO Box 609501
Orlando, FL 32860-9501
USA

Phone: +1 (407) 886-8860
Fax: +1 (407) 886-7061
Email: info-product@tqs.com
Web: www.triquint.com

Or contact one of our worldwide
Network of [sales offices](#),
[Representatives or distributors](#)