

Ceramic

# High Pass Filter

HFCN-9700+

50Ω

9700 to 16980 MHz



CASE STYLE: FV1206-4

## The Big Deal

- Small size 3.2mm x 1.6 mm
- High Power handling (7W)
- High rejection (30 dB typ)
- Ceramic construction

## Product Overview

New High Pass Filter HFCN-9700+ is an LTCC based filter, that extends the upper frequency cutoff range of the existing HFCN series to 9.7 GHz. Systems that previously relied on large distributed filter elements to support these lower frequencies can save space and system complexity by integrating the HFCN-9700+ into new designs. These filters are offered in a EIA 1206 package size and have a typical stop band rejection of 32 dB.

## Key Features

Feature	Advantages
Small Size	Available in the size of typical resistors or capacitors (EIA 1206), the ultra small HFCN series integrates an entire high pass filter into a simple SMT chip form factor.
High Power Handling	The HFCN series can withstand up to 7W CW signal without damage making this filter ideal for use in medium power to transmit paths.
Temperature Stability	Over a 155°C operating temperature range (-55°C to +100°C), the HFCN series ceramic filters typically exhibit low pass band insertion loss variation.
High Rejection	Achieving 32dB rejection from DC-6770 MHz; the HFCN-9700+ provides a versatile high pass configuration for many up converter applications.



Ceramic

# High Pass Filter

50Ω

9700 to 16980 MHz

## HFCN-9700+



CASE STYLE: FV1206-4

**+RoHS Compliant**

The +Suffix identifies RoHS Compliance. See our web site for RoHS Compliance methodologies and qualifications



Available Tape and Reel at no extra cost

Reel Size	Devices/Reel
7"	20, 50, 100, 200, 500, 1000, 3000

### Features

- low cost
- small size
- temperature stable
- excellent power handling, 7W
- hermetically sealed

### Applications

- electronic warfare (EW)
- sub-harmonic rejection
- transmitters/receivers
- lab use

### Specification Definition

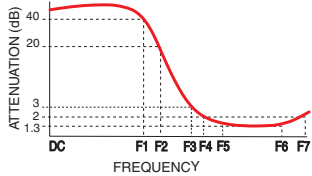

### Functional Schematic

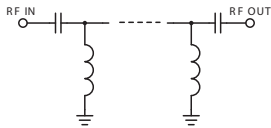

### Top View

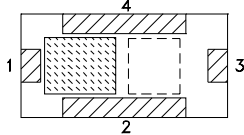

### Pad Connections

Input	1
Output	3
Ground	2,4

### Electrical Specifications<sup>(1,2)</sup> at 25°C

Parameter	F#	Frequency (MHz)	Min.	Typ.	Max.	Unit	
Stop Band	Rejection Loss	DC-F1	DC - 6770	25	32	—	dB
		F1-F2	DC - 7550	18	27	—	dB
	Freq. Cut-Off <sup>(1)</sup>	F3	9070	—	3.0	—	dB
	VSWR	DC-F2	DC - 7550	—	20	—	:1
Pass Band	Insertion Loss <sup>(3)</sup>	F4-F7	9700 - 16980	—	1.0	3.0	dB
		F5-F6	11460 - 16570	—	0.8	2.0	dB
	VSWR	F4-F7	9700 - 16980	—	1.8	—	:1

<sup>(1)</sup> In Application where DC voltage is present at either input or output ports, dc de-coupling capacitors are required.

<sup>(2)</sup> Measured on Mini-Circuits Characterization Test Board TB-860+.

<sup>(3)</sup> Referenced to mid-band loss, 1 dB typ.

### Maximum Ratings

Operating Temperature	-55°C to +100°C
Storage Temperature	-55°C to +100°C
RF Power Input*	7W at 25°C

\*Passband rating, derate linearly to 3W at 100°C ambient  
Permanent damage may occur if any of these limits are exceeded.

### Typical Performance Data at 25°C

Frequency (MHz)	Insertion Loss (dB)	VSWR (:1)
100	52.56	6169.40
500	39.17	922.97
1000	34.27	239.27
2000	32.01	101.87
3000	33.40	78.91
4000	36.36	55.49
5500	44.10	36.67
6500	43.49	30.11
6800	39.61	22.26
7550	27.48	29.33
9100	3.85	3.21
9700	1.98	2.05
11500	1.21	1.42
13000	1.03	1.29
15000	1.27	1.43
16500	1.11	1.20
17000	1.30	1.42
18000	2.95	2.91

HFCN-9700+  
INSERTION LOSS

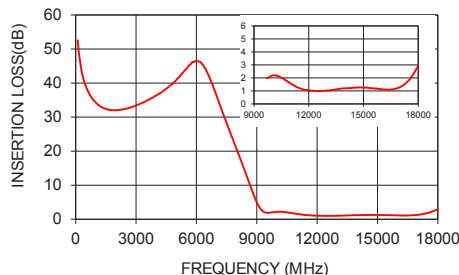

HFCN-9700+  
VSWR

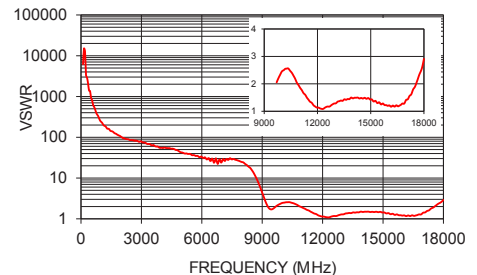

# High Pass Filter

# HFCN-9700+

## Outline Drawing

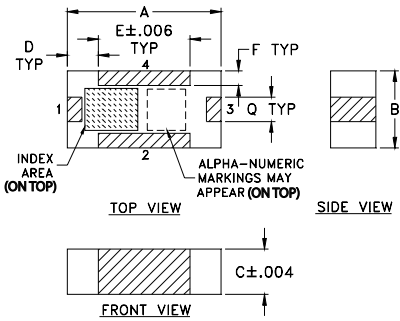

### Pad Connections

Input	1
Output	3
Ground	2,4

Product Marking: EE

### Outline Dimensions (inch/mm)

A	B	C	D	E	F	G	H	J
.126	.063	.037	.026	.075	.012	.182	.104	.069
3.20	1.60	0.94	0.66	1.91	0.30	4.62	2.64	1.75
K	L	M	N	P	Q	R		wt
.119	.041	.039	.013	.024	.020	.039		grams
3.02	1.04	0.99	0.33	0.61	0.51	0.99		.020

## PCB Land Pattern

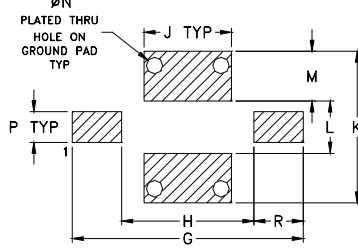

Suggested Layout,  
Tolerance to be within ±.002

## Demo Board MCL P/N: TB-860+ Suggested PCB Layout (PL-487)

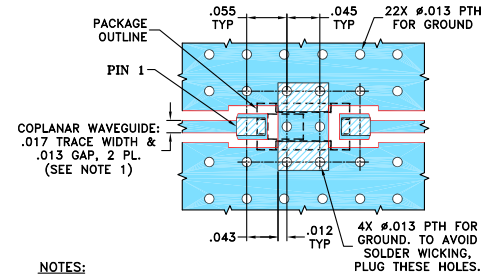

### NOTES:

- TRACE WIDTH AND GAP ARE SHOWN FOR ROGERS RO4350B WITH DIELECTRIC THICKNESS .010" ± .001". COPPER: 1/2 OZ. EACH SIDE. FOR OTHER MATERIALS TRACE WIDTH AND GAP MAY NEED TO BE MODIFIED.
- BOTTOM SIDE OF THE PCB IS CONTINUOUS GROUND PLANE.
  - DENOTES PCB COPPER LAYOUT WITH SMOBC (SOLDER MASK OVER BARE COPPER)
  - DENOTES COPPER LAND PATTERN FREE OF SOLDER MASK

### Additional Notes

- Performance and quality attributes and conditions not expressly stated in this specification document are intended to be excluded and do not form a part of this specification document.
- Electrical specifications and performance data contained in this specification document are based on Mini-Circuit's applicable established test performance criteria and measurement instructions.
- The parts covered by this specification document are subject to Mini-Circuits' standard limited warranty and terms and conditions (collectively, "Standard Terms"); Purchasers of this part are entitled to the rights and benefits contained therein. For a full statement of the Standard Terms and the exclusive rights and remedies thereunder, please visit Mini-Circuits' website at [www.minicircuits.com/MCLStore/terms.jsp](http://www.minicircuits.com/MCLStore/terms.jsp)

