

SIDE- LOOK PACKAGE PHOTOTRANSISTOR

● Features

1. Wide range of collector current.
2. Lend for high sensitivity.
3. Low cost plastic package.
4. Lens Appearance: Water Clear.
5. This product doesn't contain restriction substance, comply ROHS standard

● Description

The BPT-NP13C2 is a NPN silicon phototransistor mounted in a lensed ,water clear plastic package .

The lensing effect of the package allows an acceptance half view angle of 50° that is measured from the optical axis to the half power point .

● Package Dimensions:

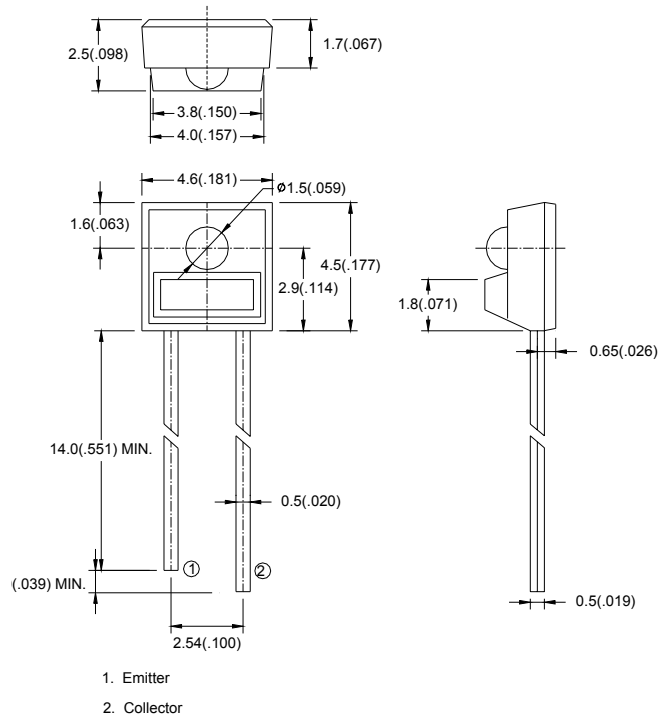

NOTES:

- 1.All dimensions are in millimeters (inches).
- 2.Tolerance is $\pm 0.25\text{mm}$ (0.01") unless otherwise specified.
- 3.Lead spacing is measured where the leads emerge from the package
- 4.Specifications are subject to change without notice

● Absolute Maximum Ratings(Ta=25°C)

Parameter	Maximum Rating	Unit
Power Dissipation	100	mW
Collector- Emitter Voltage	30	V
Emitter- Collector Voltage	5	V
Operating Temperature	-45°C ~ +85°C	
Storage Temperature Range	-45°C ~ +100°C	
Lead Soldering Temperature	260°C for 5 seconds	

● **Electrical Characteristics** (TA=25°C unless otherwise noted)

PARAMETER	SYMBOL	MIN	TYP	MAX	UNITS	TEST CONDITIONS
Collector- Emitter Breakdown Voltage	$V_{(BR)CEO}$	30	-	-	V	$I_C=1\text{ mA}$ $E_e=0\text{mW/cm}^2$
Emitter-Collector Breakdown Voltage	$V_{(BR)ECO}$	5	-	-	V	$I_R=0.1\text{mA}$ $E_e=0\text{ mW/cm}^2$
Collector- Emitter Saturation Voltage	$V_{CE(SAT)}$	-	-	0.5	V	$I_C=0.1\text{ mA}$ $E_e=1.0\text{mW/cm}^2$
Rise Time	T_r	-	25	-	μS	$V_{CE}=5\text{V}$ $R_L=1\text{K}\Omega$ $F=100\text{HZ}$
Fall Time	T_f	-	25	-		
Collector Dark Current	I_d	-	-	100	nA	$V_{CE}=10\text{V}$ $E_e=0\text{ mW/cm}^2$
Light Current	$I_{C(ON)}$	-	11	-	mA	$V_{CE}=5\text{V}$ $E_e=1.0\text{mW/cm}^2$

● **Typical Optical-Electrical Characteristic Curves**

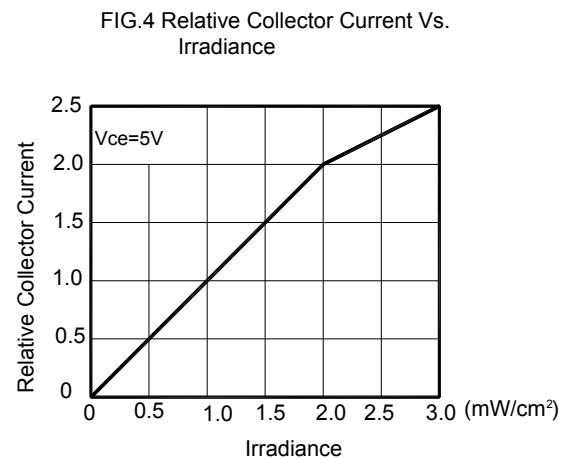
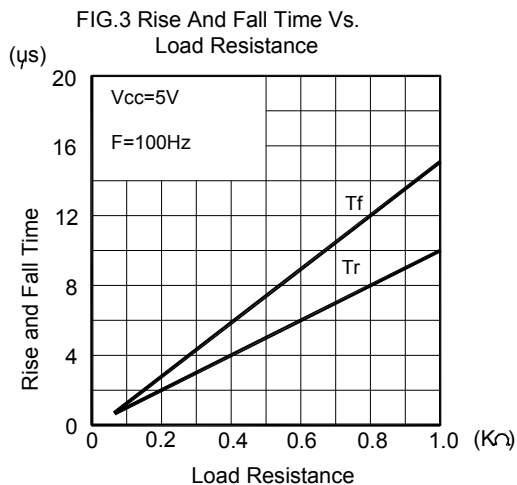
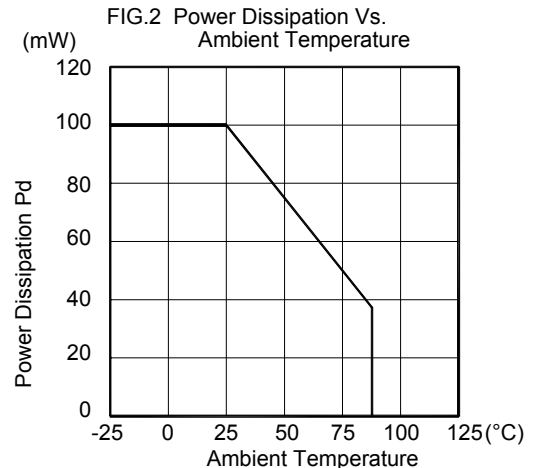
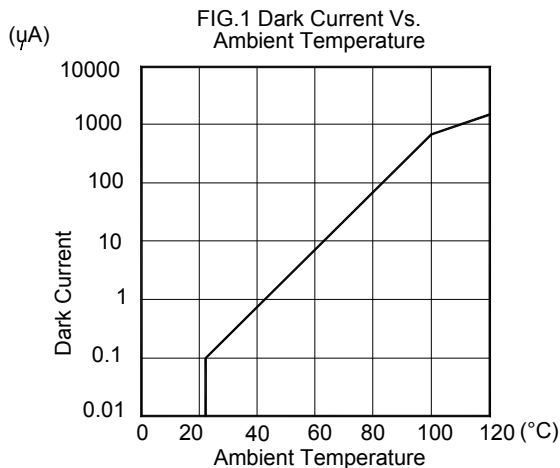

● Tapping and packaging specifications(Units: mm)

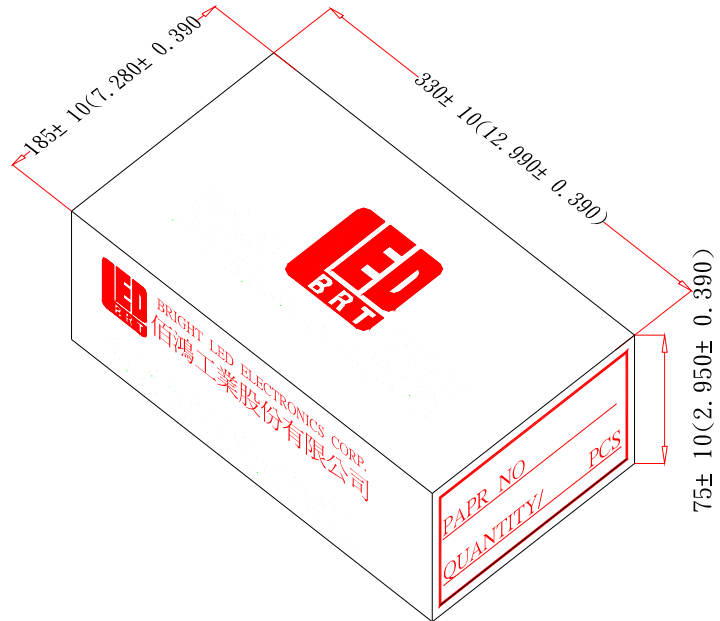

● Packaging Bag Dimensions

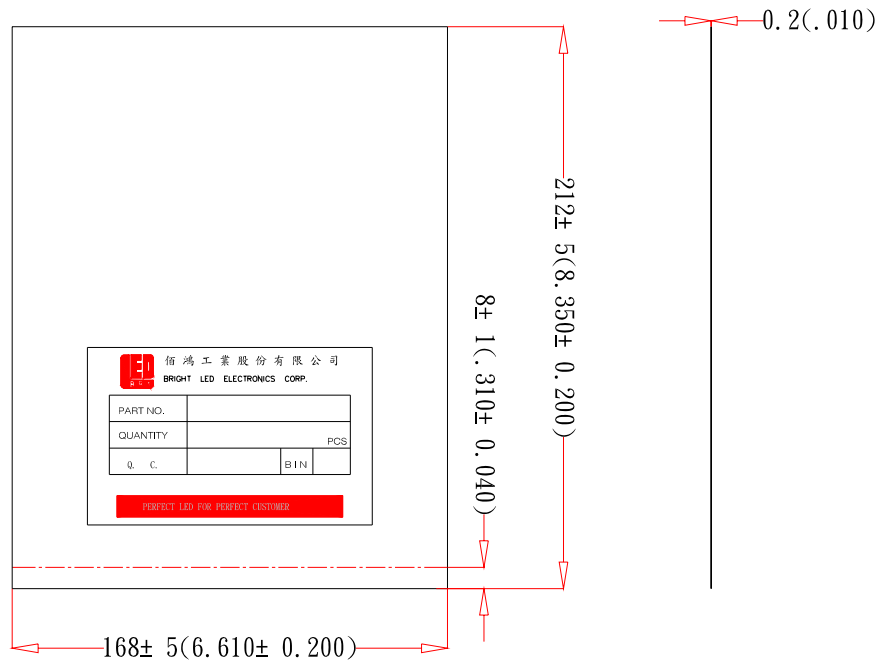

Notes:

- 1、1000pcs per bag, 8Kpcs per box.
- 2、All dimensions are in millimeters(inches).
- 3、Specifications are subject to change without notice.