



DL-3147-141(-241)

Index Guided AlGaInP Laser Diode

Overview

DL-3147-141(-241) is index guided 645 nm (Typ.) AlGaInP laser diode with low threshold current and high operating temperature. The low threshold current and high operating temperature are achieved by a strained multiple quantum well active layer. DL-3147-141(-241) is suitable for applications such as bar-code scanners, optical disc systems and other optical information systems.

Features

- Short wavelength : 645 nm (Typ.)
- Low threshold current : $I_{th} = 45$ mA (Typ.)
- High operating temperature : 60°C at 5 mW
- TE mode

Absolute Maximum Ratings at $T_c=25^{\circ}\text{C}$

Parameter	Symbol	Ratings	Unit
Light Output	P_o	7	mW
Reverse Voltage	Laser	2	V
	PIN	30	
Operating Temperature	T_{opr}	-10 to +60	$^{\circ}\text{C}$
Storage Temperature	T_{stg}	-40 to +85	$^{\circ}\text{C}$

Package Dimensions

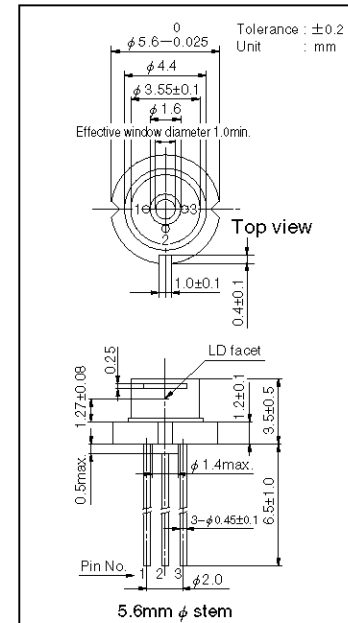

Electrical Connection

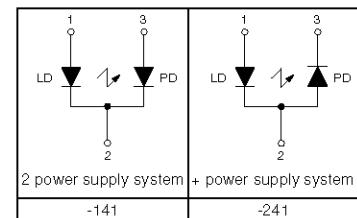

Electrical and Optical Characteristics at $T_c=25^{\circ}\text{C}$

Parameter	Symbol	Condition	Min.	Typ.	Max.	Unit
Threshold Current	I_{th}	CW	-	45	65	mA
Operating Current	I_{op}	$P_o=5\text{mW}$	-	60	80	mA
Operating Voltage	V_{op}	$P_o=5\text{mW}$	-	2.2	2.5	V
Lasing Wavelength	λ_p	$P_o=5\text{mW}$	-	645	655	nm
Beam Divergence	Perpendicular	θ_{\perp}	25	30	40	deg.
	Parallel	θ_{\parallel}	6	7.5	10	deg.
Off Axis Angle	Perpendicular	$\Delta\theta_{\perp}$	-	-	± 3	deg.
	Parallel	$\Delta\theta_{\parallel}$	-	-	± 2	deg.
Differential Efficiency	dP_o/dI_{op}	-	0.15	0.35	-	mW/mA
Monitoring Output Current	I_m	$P_o=5\text{mW}$	0.05	0.15	-	mA
Astigmatism	A_s	$P_o=5\text{mW}$	-	8	-	μm

※) Full angle at half maximum note : The above product specifications are subject to change without notice.

Characteristics

Output power vs. Forward current

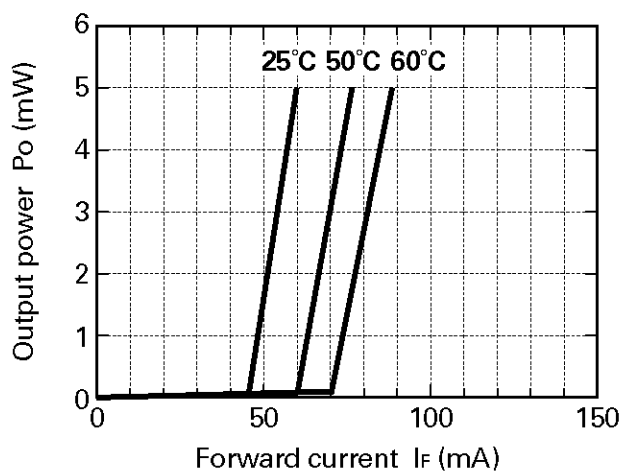

Threshold current vs. Temperature

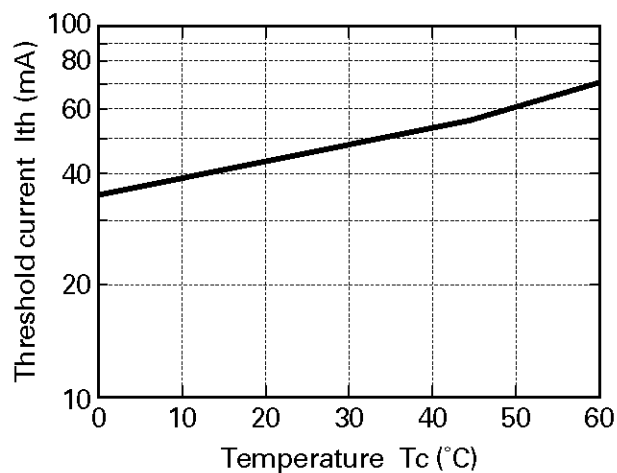

Monitor current vs. Output power

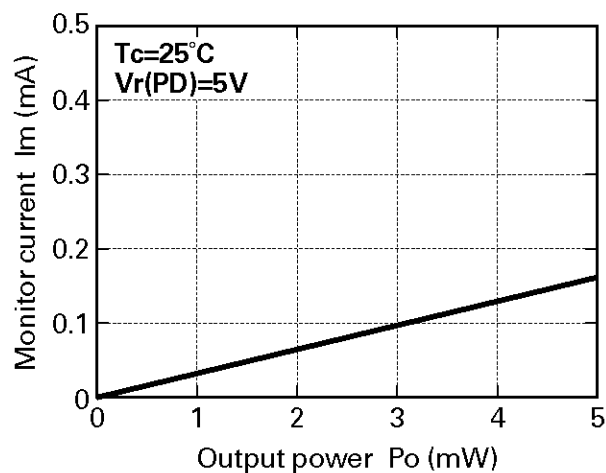

Beam divergence

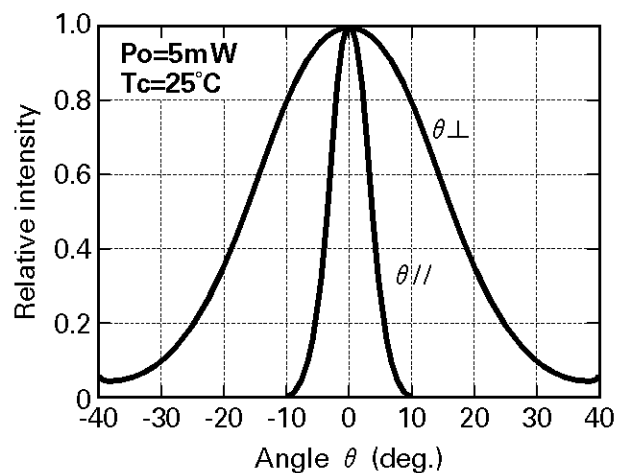

Lasing wavelength vs. Temperature

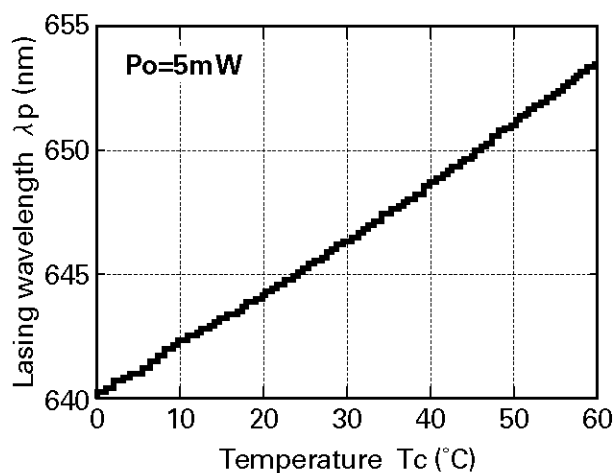

Output power vs. Lasing wavelength

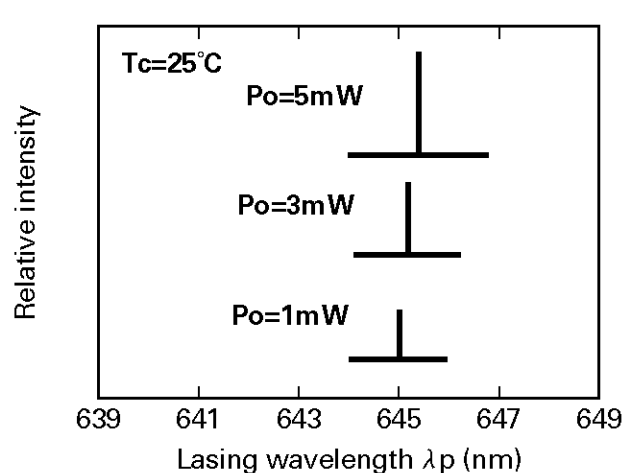

 **CAUTION**

1. No products described or contained herein are intended for use in surgical implants, life-support systems, aerospace equipment, nuclear power control systems, vehicles, disaster / crime-prevention equipment or the like, and the failure of which may directly or indirectly cause injury, death or property loss.
2. Anyone purchasing any products described or contained herein for an above-mentioned use shall:
 - 1) Accept full responsibility and indemnify and defend SANYO ELECTRIC CO.,LTD., it's affiliates, subsidiaries and distributors or any of their officers and employees, jointly and severally, against any and all claims and litigation and all damages, costs and expenses associated with such use.
 - 2) Not impose any responsibility for any fault or negligence which may be cited in any such claim or litigation on SANYO ELECTRIC CO., LTD., it's affiliates, subsidiaries and distributors or any of their officers and employees jointly or severally.
3. Information (including circuit diagrams and circuit parameters) disclosed herein is for example only; it is not guaranteed for mass production, SANYO believes the information disclosed herein is accurate and reliable, but no guarantees are made or implied regarding it's use or any infringements of intellectual property rights or other rights of third parties.

Precautionary instructions in handling gallium arsenic products

Special precautions must be taken in handling this product because it contains, gallium arsenic, which is designated as a toxic substance by law. Be sure to adhere strictly to all applicable laws and regulations enacted for this substance, particularly when it comes to disposal.

Manufactured by ; **Tottori SANYO Electric Co., Ltd.**
Electronics Device Bussiness Headquarters LED Division
5-318, Tachikawa-cho, Tottori City, 680 Japan
TEL: +81-857-21-2137 FAX: +81-857-21-2161