

## Features

- Formerly **FulTec** brand
- Extremely high speed performance
- Blocks high voltages and currents
- Two TBU™ protectors in one small package
- Simple, superior circuit protection
- Minimal PCB area
- RoHS compliant\*, UL Recognized

## Applications

- POTS linecards
- VoIP equipment
- Voice and data combo linecards
- ONU, ONT
- Gateways
- Cable and DSL modems

## TBU™ P500-G and P850-G Protectors

### Transient Blocking Units - TBU™ Devices

Bourns® Model P500-G and P850-G TBU™ products are high speed, surge protection components designed to protect Subscriber Line Interface Circuits (SLICs) against transients caused by AC power cross, induction and lightning surges.

The TBU™ device blocks surges and provides an effective barrier behind which sensitive electronics are not exposed to large voltages or currents during surge events.

### Agency Approval

UL recognized component File # E315805.

### Industry Standards

Description			Model
Telcordia	GR-1089	Port Type 2, 4	P500-G
		Port Type 3, 5	P850-G
ITU-T	K.20, K.20E, K.21, K.21E, K.45		P850-G

### Absolute Maximum Ratings (T<sub>amb</sub> = 25 °C)

Symbol	Parameter	Value	Unit	
V <sub>imp</sub>	Maximum protection voltage for impulse faults with rise time ≥ 1 μsec	P500-Gxxx-WH P850-Gxxx-WH	500 850	V
V <sub>rms</sub>	Maximum protection voltage for continuous V <sub>rms</sub> faults	P500-Gxxx-WH P850-Gxxx-WH	300 425	V
T <sub>op</sub>	Operating temperature range		-40 to +85	°C
T <sub>stg</sub>	Storage temperature range		-65 to +150	°C

### Electrical Characteristics (T<sub>amb</sub> = 25 °C)

Symbol	Parameter	Min.	Typ.	Max.	Unit
I <sub>op</sub>	Maximum current through the device that will not cause current blocking			100 200 100 200	mA
I <sub>trigger</sub>	Typical current for the device to go from normal operating state to protected state		150 275 150 275		mA
I <sub>out</sub>	Maximum current through the device			200 400 200 400	mA
R <sub>TBU</sub>	Series resistance of the TBU™ device		50	55	Ω
R <sub>bal</sub>	Line-to-line series resistance difference between two TBU™ devices			2	Ω
t <sub>block</sub>	Maximum time for the device to go from normal operating state to protected state			1	μs
I <sub>quiescent</sub>	Current through the triggered TBU™ device with 50 Vdc circuit voltage		0.7		mA
V <sub>reset</sub>	Voltage below which the triggered TBU™ device will transition to normal operating state		22		V

The P-G series TBU™ devices are bidirectional; specifications are valid in both directions.

\*RoHS Directive 2002/95/EC Jan 27 2003 including Annex.

Specifications are subject to change without notice.

Customers should verify actual device performance in their specific applications

Typical Performance Characteristics

V-I Characteristics

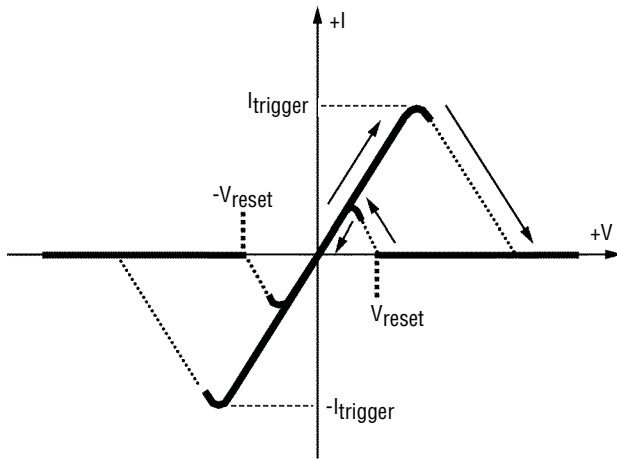

Time to Block vs. Fault Current

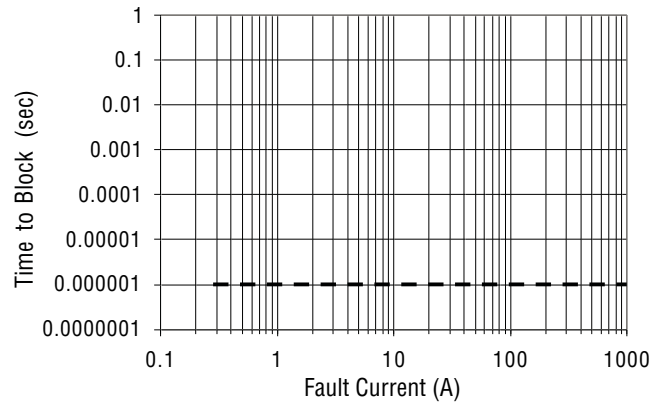

Trigger Current Temperature

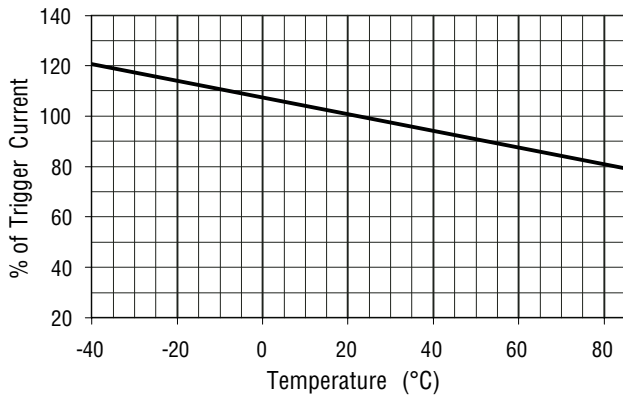

## Operational Characteristics

The graphs below demonstrate the operational characteristics of the TBU™ device. For each graph the fault voltage, protected side voltage, and current is presented.

TEST CONFIGURATION DIAGRAM

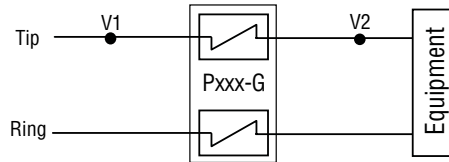

P500-G Lightning, 500 V

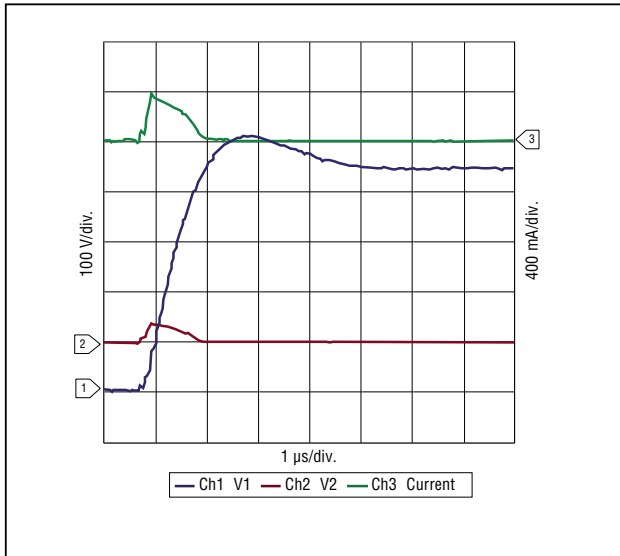

P850-G Lightning, 850 V

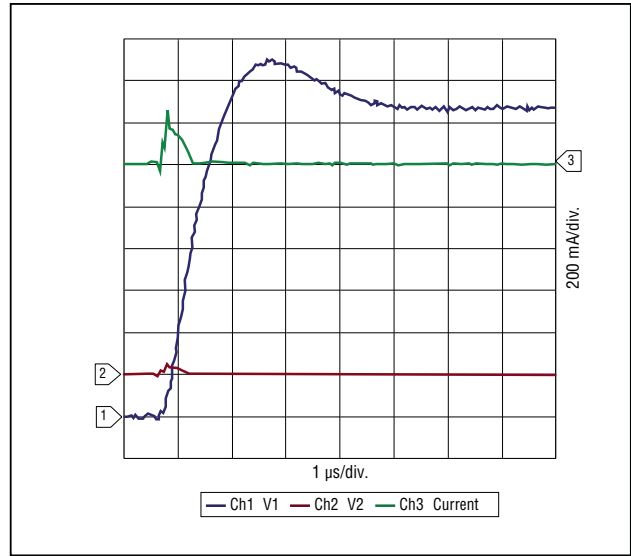

P500-G Power Fault, 120 Vrms, 25 A

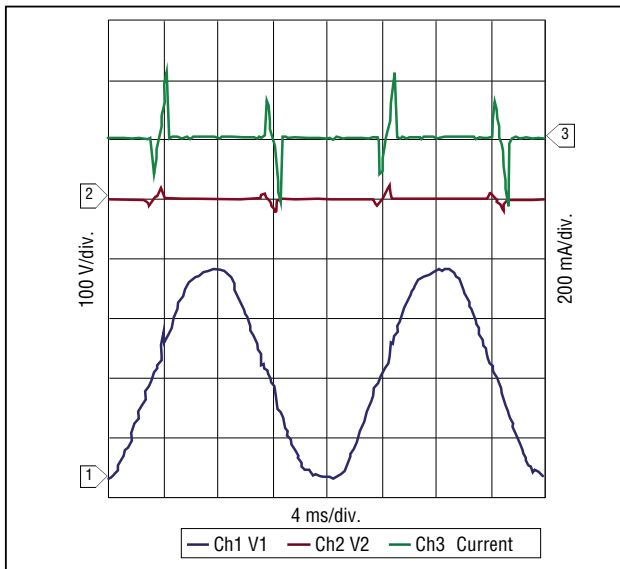

P850-G Power Fault, 230 Vrms, 25 A

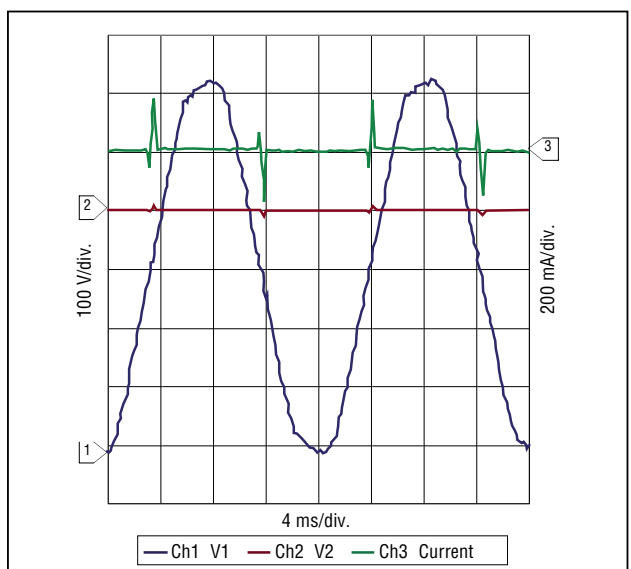

# TBU™ P500-G and P850-G Protectors

# BOURNS®

## Product Dimensions

### P500-Gxxx

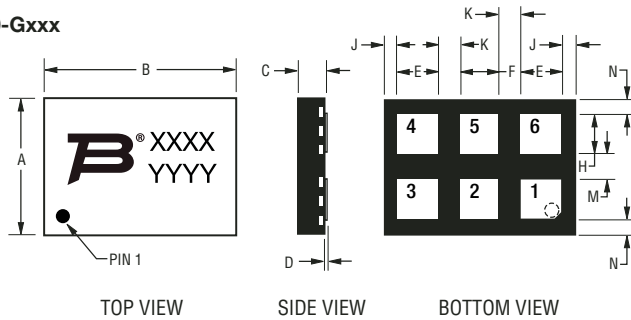

### P850-Gxxx

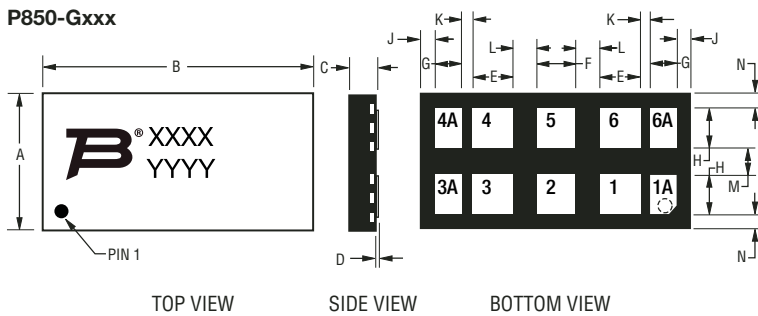

Pads 1A and 1 are internally connected; the same for pads 3A with 3, 4A with 4, and 6A with 6. This allows for one PCB layout to accommodate the P500 or P850.

Dim.	P500-G			P850-G		
	Min.	Typ.	Max.	Min.	Typ.	Max.
A	3.40 (.139)	4.00 (.157)	4.10 (.161)	3.40 (.139)	4.00 (.157)	4.10 (.161)
B	5.90 (.232)	6.00 (.236)	6.10 (.240)	8.15 (.321)	8.25 (.325)	8.35 (.329)
C	0.80 (.031)	0.85 (.033)	0.90 (.035)	0.80 (.031)	0.85 (.033)	0.90 (.035)
D	0.000 (.000)	0.025 (.001)	0.050 (.002)	0.000 (.000)	0.025 (.001)	0.050 (.002)
E	1.15 (.045)	1.25 (.049)	1.35 (.053)	1.15 (.045)	1.25 (.049)	1.35 (.053)
F	1.05 (.041)	1.15 (.045)	1.25 (.049)	1.05 (.041)	1.15 (.045)	1.25 (.049)
G	--	--	--	0.725 (.029)	0.825 (.032)	0.925 (.036)
H	1.10 (.043)	1.20 (.047)	1.30 (.051)	1.10 (.043)	1.20 (.047)	1.30 (.051)
J	0.375 (.015)	0.425 (.017)	0.475 (.019)	0.375 (.015)	0.425 (.017)	0.475 (.019)
K	0.70 (.028)	0.75 (.030)	0.80 (.031)	0.25 (.010)	0.30 (.012)	0.35 (.014)
L	--	--	--	0.70 (.028)	0.75 (.030)	0.80 (.031)
M	0.70 (.028)	0.75 (.030)	0.80 (.031)	0.70 (.028)	0.75 (.030)	0.80 (.031)
N	0.375 (.015)	0.425 (.017)	0.475 (.018)	0.375 (.015)	0.425 (.017)	0.475 (.018)

DIMENSIONS:  $\frac{\text{MM}}{(\text{INCHES})}$

## Recommended Pad Layout

### P500-Gxxx

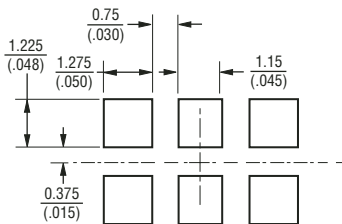

### Pad Designation

Pad #	Apply
1	Tip In
2	NC
3	Tip Out
4	Ring Out
5	NC
6	Ring In

NC = Solder to PCB; do not make electrical connection, do not connect to ground.

### P850-Gxxx

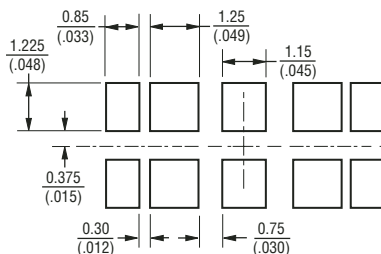

### Pad Designation

Pad #	Apply	Pad #	Apply
1A	Tip In	4A	Ring Out
1	Tip In	4	Ring Out
2	NC	5	NC
3	Tip Out	6	Ring In
3A	Tip Out	6A	Ring In

NC = Solder to PCB; do not make electrical connection, do not connect to ground.

## Block Diagram

### P500-Gxxx

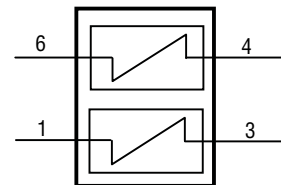

### P850-Gxxx

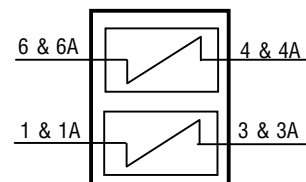

TBU™ devices have matte-tin termination finish. Suggested layout should use non-solder mask define (NSMD). Recommended stencil thickness is 0.10-0.12 mm (.004-.005 in.) with stencil opening size 0.025 mm (.0010 in.) less than the device pad size. As when heat sinking any power device, it is recommended that, wherever possible, extra PCB copper area is allowed. For minimum parasitic capacitance, do not allow any signal, ground or power signals beneath any of the pads of the device.

Specifications are subject to change without notice. Customers should verify actual device performance in their specific applications

## Thermal Resistances

Part #	Symbol	Parameter	Value	Unit
P500-G	$R_{th(j-a)}$	Junction to leads (package)	113	°C/W
		Junction to leads (per TBU™ device)	236	°C/W
P850-G	$R_{th(j-a)}$	Junction to leads (package)	119	°C/W
		Junction to leads (per TBU™ device)	215	°C/W

## Reflow Profile

Profile Feature	Pb-Free Assembly
Average Ramp-Up Rate (T <sub>smax</sub> to T <sub>p</sub> )	3 °C/sec. max.
Preheat	
- Temperature Min. (T <sub>smin</sub> )	150 °C
- Temperature Max. (T <sub>smax</sub> )	200 °C
- Time (t <sub>smin</sub> to t <sub>smax</sub> )	60-180 sec.
Time maintained above:	
- Temperature (T <sub>L</sub> )	217 °C
- Time (t <sub>L</sub> )	60-150 sec.
Peak/Classification Temperature (T <sub>p</sub> )	260 °C
Time within 5 °C of Actual Peak Temp. (t <sub>p</sub> )	20-40 sec.
Ramp-Down Rate	6 °C/sec. max.
Time 25 °C to Peak Temperature	8 min. max.

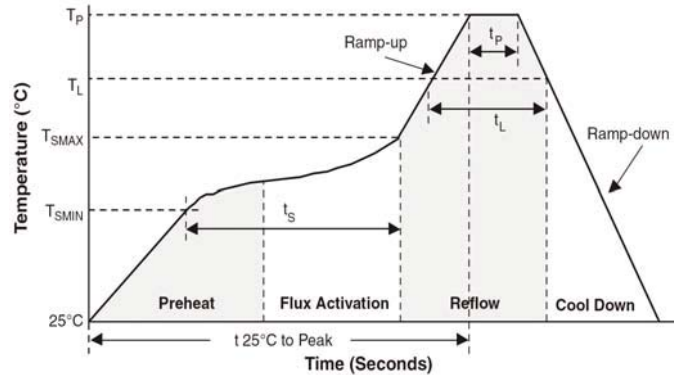

# TBU™ P500-G and P850-G Protectors

# BOURNS®

## How to Order

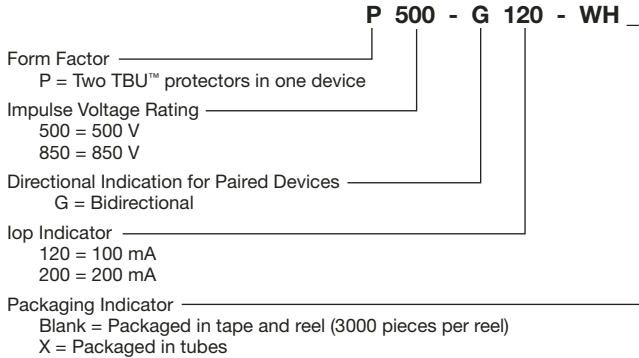

## Typical Part Marking

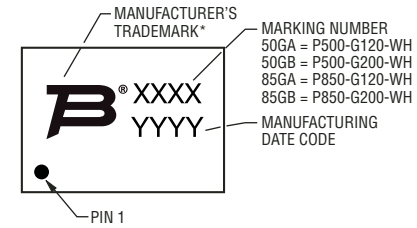

\*TRANSITION FROM FULTEC TRADEMARK TO BOURNS TRADEMARK IN 2009.

## Packaging Specifications (per EIA468-B)

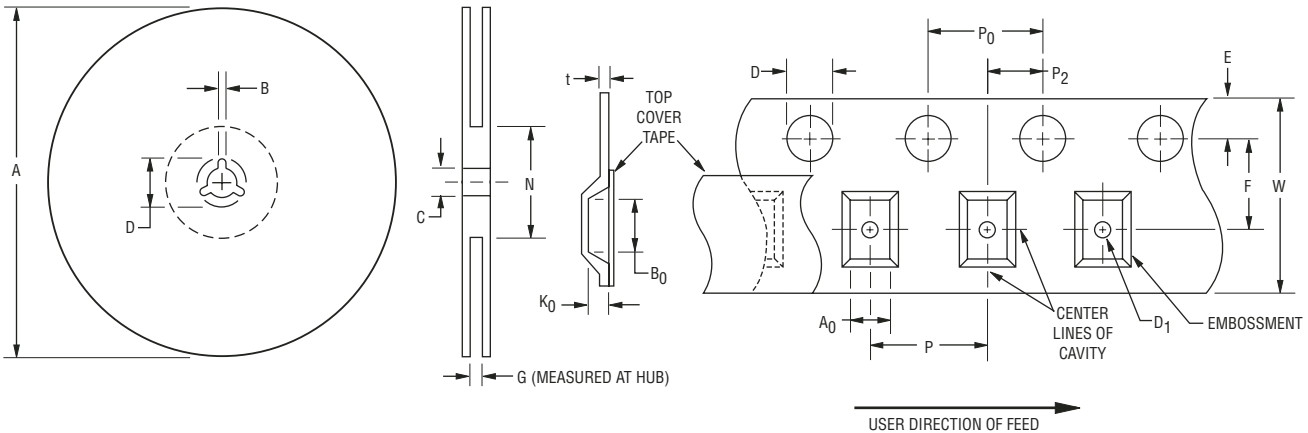

Device	A		B		C		D		G	N
	Min.	Max.	Min.	Max.	Min.	Max.	Min.	Max.	Ref.	Ref.
P500-G, P850-G	326 (12.835)	330.25 (13.002)	1.5 (.059)	2.5 (.098)	12.8 (.504)	13.5 (.531)	20.2 (.795)	-	16.5 (.650)	102 (4.016)

Device	A <sub>0</sub>		B <sub>0</sub>		D		D <sub>1</sub>		E		F	
	Min.	Max.	Min.	Max.	Min.	Max.	Min.	Max.	Min.	Max.	Min.	max.
P500-G	4.2 (.165)	4.4 (.173)	6.2 (.244)	6.4 (.252)	1.5 (.059)	1.6 (.063)	1.5 (.059)	-	1.65 (.065)	1.85 (.073)	5.4 (.213)	5.6 (.220)
P850-G	4.2 (.165)	4.4 (.173)	8.45 (.333)	8.65 (.341)	1.5 (.059)	1.6 (.063)	1.5 (.059)	-	1.65 (.065)	1.85 (.073)	7.4 (.291)	7.6 (.299)

Device	K <sub>0</sub>		P		P <sub>0</sub>		P <sub>2</sub>		t		W	
	Min.	Max.	Min.	Max.	Min.	Max.	Min.	Max.	Min.	Max.	Min.	Max.
P500-G	1.0 (.039)	1.2 (.047)	7.9 (.311)	8.1 (.319)	3.9 (.159)	4.1 (.161)	1.9 (.075)	2.1 (.083)	0.25 (.010)	0.35 (.014)	11.7 (.461)	12.3 (.484)
P850-G	1.1 (.043)	1.3 (.051)	7.9 (.311)	8.1 (.319)	3.9 (.159)	4.1 (.161)	1.9 (.075)	2.1 (.083)	0.25 (.010)	0.35 (.014)	15.7 (.618)	16.3 (.642)

DIMENSIONS:  $\frac{\text{MM}}{\text{(INCHES)}}$

Specifications are subject to change without notice.  
 Customers should verify actual device performance in their specific applications

# TBU™ P500-G and P850-G Protectors



## Reference Designs

A cost-effective protection solution combines the Bourns® TBU™ protection device with a pair of MOVs or Bourns® GDTs and a diode bridge. The diagram below illustrates a common configuration of these components. The graphs to the right demonstrate the operational characteristics of the circuit.

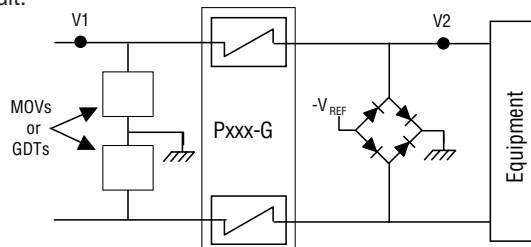

Common Configuration Diagram

P500-G Configuration (GR-1089 Intra-building and 5 kV Lightning)			
Product	Qty.	Part Number	Source
TBU™ Device	1	P500-Gxxx-WH	Bourns, Inc.
MOV	2	CNR-10D201K GNR10D201K	CNR Centra Science Ceramate Technical
Diode bridge	2	GSD2004S-V MMBD2004S	Vishay Diodes Inc.

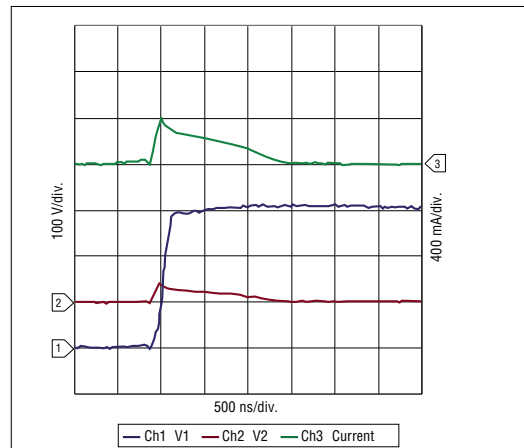

P500-G Solution: 5000 V Lightning 2/10  $\mu$ sec, 500 A

P850-G Configuration (ITU-T K.20, K.21, K.20E, K.21E, K.45)			
Product	Qty.	Part Number	Source
TBU™ Device	1	P850-G120-WH	Bourns, Inc.
MOV	2	CNR-10D361K GNR10D361K	CNR Centra Science Ceramate Technical
Diode bridge	2	GSD2004S-V MMBD2004S	Vishay Diodes Inc.

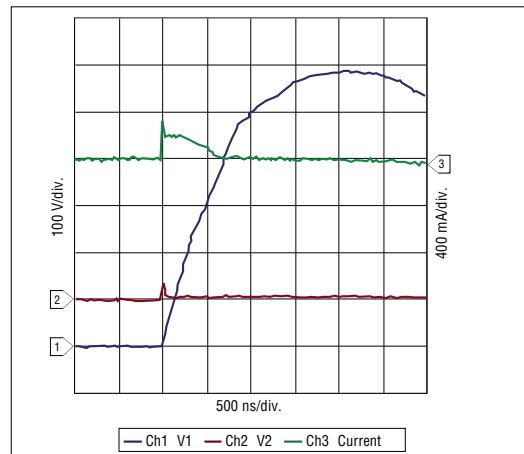

P850-G Solution: 4000 V Lightning 10/700  $\mu$ sec, 100 A



**Asia-Pacific:** Tel: +886-2 2562-4117 • Fax: +886-2 2562-4116  
**Europe:** Tel: +41-41 768 5555 • Fax: +41-41 768 5510  
**The Americas:** Tel: +1-951 781-5500 • Fax: +1-951 781-5700  
[www.bourns.com](http://www.bourns.com)