

Ultra-Sensitive Dual-Channel Quadrature Hall-Effect Bipolar Switch

Features and Benefits

- Two matched Hall effect switches on a single substrate
- Sensor Hall element spacing approximately 1 mm
- Superior temperature stability
- 3.3 to 18 V operation
- Integrated ESD diode from OUTPUT and VCC pins to GND
- High-sensitivity switchpoints
- Robust structure for EMC protection
- Solid-state reliability

Package: 8 pin SOIC (suffix L), and 4 pin SIP (suffix K)

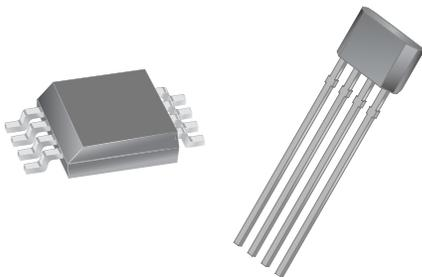

Not to scale

Description

The A3425 is a dual-output-channel, bipolar switch with each channel comprising a separate complete Hall-effect sensor circuit with dedicated Hall element and separate digital output for speed and direction signal processing capability. The independent Hall elements (E1 integrated with OUTPUTA, and E2 integrated with OUTPUTB) are photolithographically aligned to better than 1 μm . Maintaining this accurate mechanical location between the two active Hall elements eliminates the major manufacturing hurdle encountered in fine-pitch detection applications. The A3425 is a highly sensitive, temperature-stable magnetic sensing device, which is ideal for use in ring magnet-based speed and direction systems used in harsh automotive and industrial environments.

The A3425 contains two independent Hall effect switches, and has a monolithic IC that accurately locates the two Hall elements, E1 and E2, approximately 1 mm apart. The digital outputs are 90° out of phase so that the outputs are in quadrature, with the proper ring magnet design. This allows for easy processing of speed and direction signals. Extremely low-drift amplifiers guarantee symmetry between the switches to maintain signal

Continued on the next page...

Typical Application

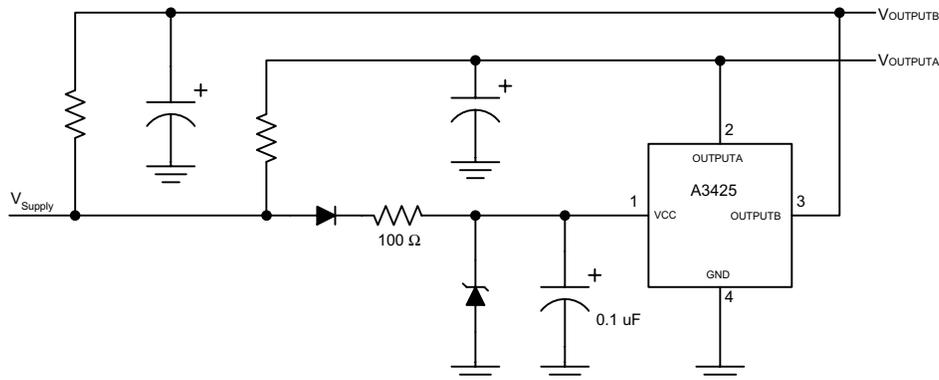

Using unregulated supply

A3425

Ultra-Sensitive Dual-Channel Quadrature Hall-Effect Bipolar Switch

Description (continued)

quadrature. The patented chopper stabilization technique cancels offsets in each channel, and provides stable operation over the operating temperature and voltage ranges. An on-chip regulator allows the use of this device over a wide operating voltage range. Post-assembly factory programming provides sensitive switchpoints

that are symmetrical between the two switches.

The A3425 is available in a plastic 8-pin SOIC surface mount package (L) and a plastic 4-pin SIP (K), both in two operating temperature ranges. Each package is available in a lead (Pb) free version with 100% matte tin plated leadframe.

Selection Guide

Part Number	Pb-free ¹	Packing ²	Mounting	Ambient, T _A
A3425EK-T	Yes	Bulk, 500 pieces/bag	4-pin SIP through hole	-40°C to 85°C
A3425EKTN-T	Yes	13-in. reel, 4000 pieces/reel		
A3425EL-T	Yes	Bulk, 500 pieces/bag	8-pin SOIC surface mount	
A3425ELTR-T	Yes	13-in. reel, 3000 pieces/reel		
A3425LK-T	Yes	Bulk, 98 pieces/bag	4-pin SIP through hole	-40°C to 150°C
A3425LKTN-T	Yes	13-in. reel, 4000 pieces/reel		
A3425LL-T	Yes	Bulk, 500 pieces/bag	8-pin SOIC surface mount	
A3425LLTR-T	Yes	13-in. reel, 3000 pieces/reel		

¹Pb-based variants are being phased out of the product line. The variants cited in this footnote are in production but have been determined to be NOT FOR NEW DESIGN. This classification indicates that sale of this device is currently restricted to existing customer applications. The variants should not be purchased for new design applications because obsolescence in the near future is probable. Samples are no longer available. Status change: May 1, 2006. These variants include: A3425EL, A3425ELTR, A3425LL, and A3425LLTR.

²Contact Allegro for additional packing options.



Absolute Maximum Ratings

Characteristic	Symbol	Notes	Rating	Units
Supply Voltage	V _{CC}		26.5	V
Reverse Battery Voltage	V _{RCC}		-16	V
Output Off Voltage	V _{OUTPUT}		V _{CC}	V
Output Sink Current	I _{OUTPUT(SINK)}		Internally Limited	-
Magnetic Flux Density	B		Unlimited	-
Operating Ambient Temperature	T _A	Range E	-40 to 85	°C
		Range L	-40 to 150	°C
Maximum Junction Temperature	T _{J(max)}		165	°C
Storage Temperature	T _{stg}		-65 to 170	°C

Functional Block Diagram

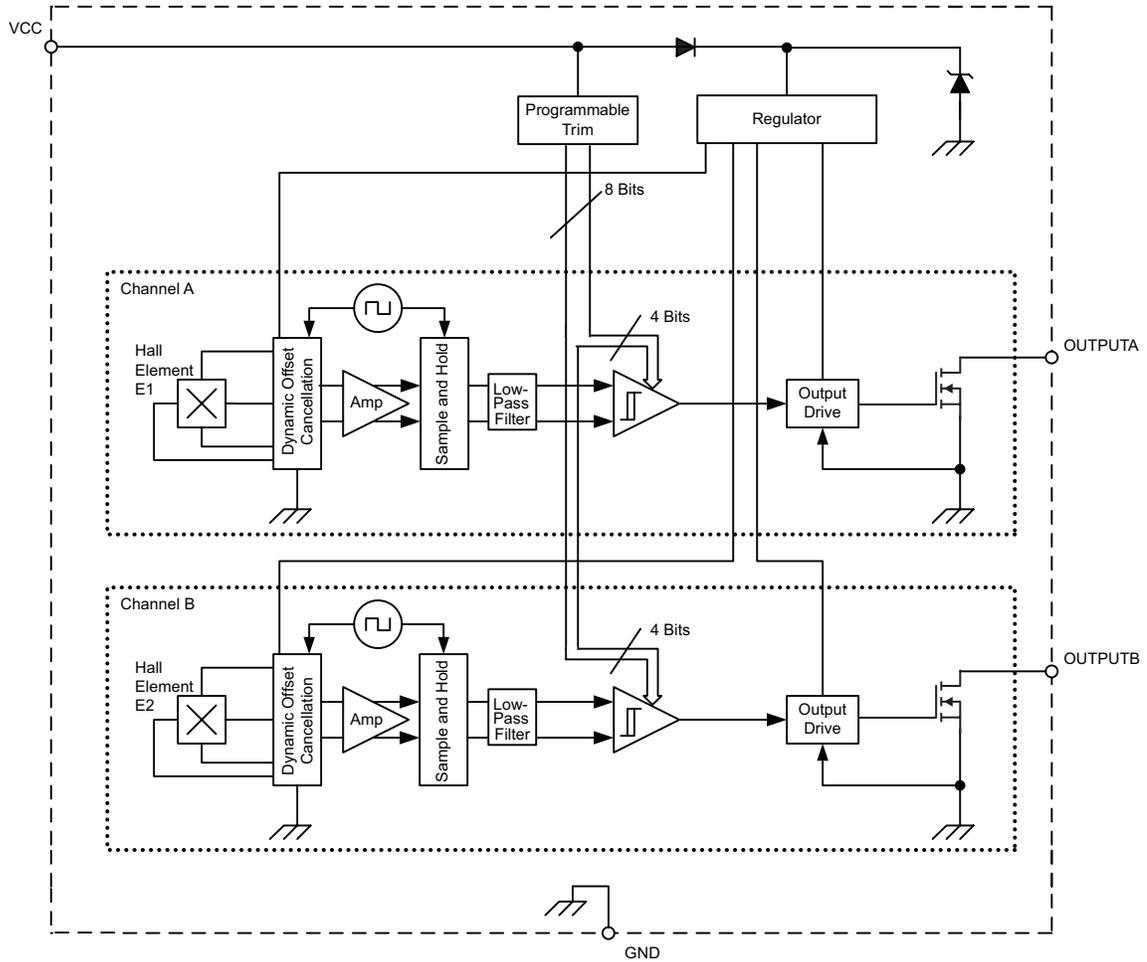

Package K

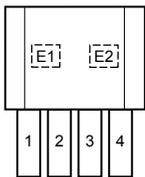

Package L

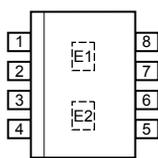

Terminal List Table

Pin Number		Name	Function
Package K	Package L		
1	1	VCC	Connects power supply to on-chip voltage regulator
2	2	OUTPUTA	Output from E1 via first Schmitt circuit
3	3	OUTPUTB	Output from E2 via second Schmitt circuit
4	4	GND	Terminal for ground connection
-	5-8	NC	No connection

OPERATING CHARACTERISTICS Valid over operating temperature ranges unless otherwise noted; typical data applies to $V_{CC} = 12\text{ V}$, and $T_A = 25^\circ\text{C}$

Characteristic	Symbol	Test Conditions	Min.	Typ.	Max	Units
ELECTRICAL CHARACTERISTICS						
Supply Voltage ¹	V_{CC}	Operating; $T_A \leq 150^\circ\text{C}$	3.3	–	18	V
Output Leakage Current	$I_{\text{OUTPUT(OFF)}}$	Either output	–	< 1	10	μA
Output Rise Time	t_r	$C_{\text{LOAD}} = 20\text{ pF}$, $R_{\text{LOAD}} = 820\ \Omega$	–	1.8	–	μs
Output Fall Time	t_f	$C_{\text{LOAD}} = 20\text{ pF}$, $R_{\text{LOAD}} = 820\ \Omega$	–	1.2	–	μs
Supply Current	$I_{\text{CC(OFF)}}$	$B < B_{\text{RP(A)}}$, $B < B_{\text{RP(B)}}$	–	3.5	6.0	mA
	$I_{\text{CC(ON)}}$	$B > B_{\text{OP(A)}}$, $B > B_{\text{OP(B)}}$	–	4.0	6.0	mA
Low Output Voltage	$V_{\text{OUTPUT(ON)}}$	Both outputs; $I_{\text{OUTPUT(SINK)}} = 20\text{ mA}$; $B > B_{\text{OP(A)}}$, $B > B_{\text{OP(B)}}$	–	160	500	mV
Output Sink Current	$I_{\text{OUTPUT(SINK)}}$		–	–	20	mA
Output Sink Current, Continuous ²	$I_{\text{OUTPUT(SINK)C}}$	$T_J < T_{\text{J(max)}}$, $V_{\text{OUTPUT}} = 12\text{ V}$	–	–	70	mA
Output Sink Current, Peak ³	$I_{\text{OUTPUT(SINK)P}}$	$t < 3\text{ seconds}$	–	–	220	mA
Chopping Frequency	f_C		–	340	–	kHz
TRANSIENT PROTECTION CHARACTERISTICS						
Supply Zener Voltage	V_Z	$I_{\text{CC}} = 15\text{ mA}$	28	33	37	V
Supply Zener Current ⁴	I_Z	$V_S = 28\text{ V}$	–	–	9.0	mA
Reverse-Battery Current	I_{RCC}	$V_{\text{RCC}} = -18\text{ V}$, $T_J < T_{\text{J(max)}}$	–	2	15	mA

Continued on the next page...

OPERATING CHARACTERISTICS (continued) Valid over operating temperature ranges unless otherwise noted; typical data applies to $V_{CC} = 12\text{ V}$, and $T_A = 25^\circ\text{C}$

Characteristic	Symbol	Test Conditions	Min.	Typ.	Max	Units
MAGNETIC CHARACTERISTICS, K Package⁵						
Operate Point: $B > B_{OP}$	$B_{OP(A)}, B_{OP(B)}$		–	7	35	G
Release Point: $B < B_{RP}$	$B_{RP(A)}, B_{RP(B)}$		–35	–7	–	G
Hysteresis: $B_{OP(A)} - B_{RP(A)}$, $B_{OP(B)} - B_{RP(B)}$	$B_{HYS(A)}, B_{HYS(B)}$		5	16	40	G
Symmetry: Channel A, Channel B, $B_{OP(A)} + B_{RP(A)}, B_{OP(B)} + B_{RP(B)}$	SYM_A, SYM_B		–40	–	40	G
Operate Symmetry: $B_{OP(A)} - B_{OP(B)}$	$SYM_{AB(OP)}$		–30	–	30	G
Release Symmetry: $B_{RP(A)} - B_{RP(B)}$	$SYM_{AB(RP)}$		–30	–	30	G
MAGNETIC CHARACTERISTICS, L Package⁵						
Operate Point: $B > B_{OP}$	$B_{OP(A)}, B_{OP(B)}$		–	7	30	G
Release Point: $B < B_{RP}$	$B_{RP(A)}, B_{RP(B)}$		–30	–7	–	G
Hysteresis: $B_{OP(A)} - B_{RP(A)}$, $B_{OP(B)} - B_{RP(B)}$	$B_{HYS(A)}, B_{HYS(B)}$		5	14	35	G
Symmetry: Channel A, Channel B, $B_{OP(A)} + B_{RP(A)}, B_{OP(B)} + B_{RP(B)}$	SYM_A, SYM_B		–35	–	35	G
Operate Symmetry: $B_{OP(A)} - B_{OP(B)}$	$SYM_{AB(OP)}$		–25	–	25	G
Release Symmetry: $B_{RP(A)} - B_{RP(B)}$	$SYM_{AB(RP)}$		–25	–	25	G

¹ When operating at maximum voltage, never exceed maximum junction temperature, $T_{J(max)}$. Refer to power derating curve charts.

² Device will survive the current level specified, but operation within magnetic specification cannot be guaranteed.

³ Short circuit of the output to VCC is protected for the time duration specified.

⁴ Maximum specification limit is equivalent to $I_{CC(max)} + 3\text{ mA}$.

⁵ Magnetic flux density, B, is indicated as a negative value for north-polarity magnetic fields, and as a positive value for south-polarity magnetic fields. This so-called algebraic convention supports arithmetic comparison of north and south polarity values, where the relative strength of the field is indicated by the absolute value of B, and the sign indicates the polarity of the field (for example, a –100 G field and a 100 G field have equivalent strength, but opposite polarity).

EMC

Contact Allegro MicroSystems for EMC performance.

THERMAL CHARACTERISTICS may require derating at maximum conditions, see application information

Characteristic	Symbol	Test Conditions*	Value	Units
Package Thermal Resistance	$R_{\theta JA}$	Package K, 1-layer PCB with copper limited to solder pads	177	$^{\circ}\text{C}/\text{W}$
		Package L-8 pin, 1-layer PCB with copper limited to solder pads	140	$^{\circ}\text{C}/\text{W}$
		Package L-8 pin, 4-layer PCB based on JEDEC standard	80	$^{\circ}\text{C}/\text{W}$

*Additional thermal data available on the Allegro Web site.

Power Derating Curve

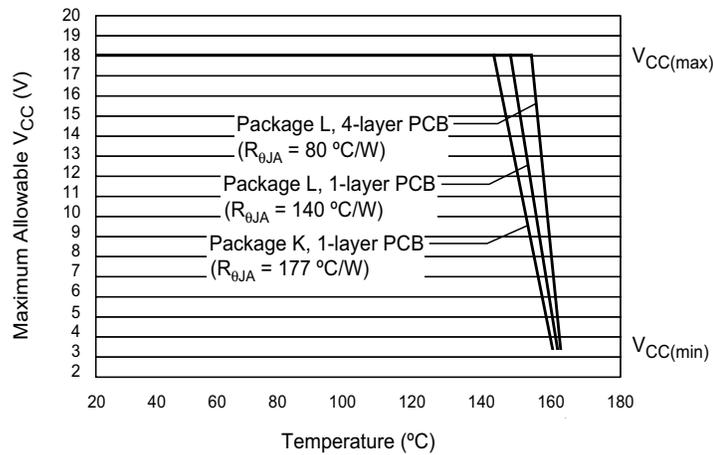

Power Dissipation versus Temperature

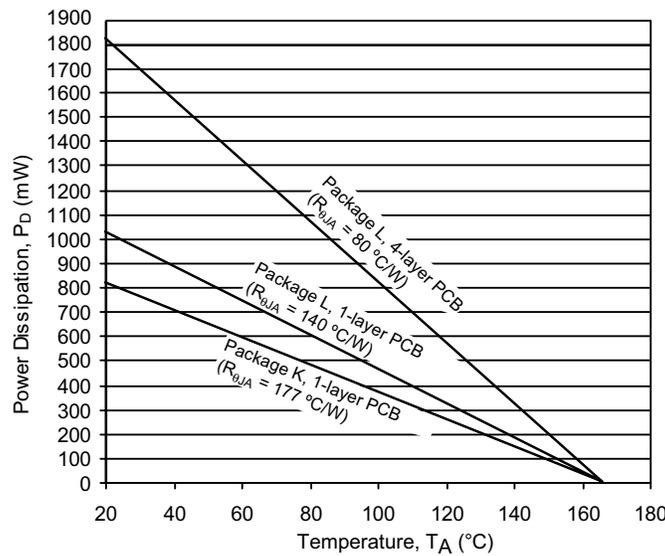

Functional Description

Chopper-Stabilized Technique

When using Hall effect technology, a limiting factor for switchpoint accuracy is the small signal voltage developed across the Hall element. This voltage is disproportionately small relative to the offset that can be produced at the output of the Hall device. This makes it difficult to process the signal and maintain an accurate, reliable output over the specified temperature and voltage range.

Chopper stabilization is a unique approach used to minimize Hall offset on the chip. The patented Allegro technique, *dynamic quadrature offset cancellation*, removes key sources of the output drift induced by thermal and mechanical stress. This offset reduction technique is based on a signal modulation-demodulation process. The undesired offset signal is separated from the magnetically induced signal in the frequency domain through modulation. The subsequent demodulation acts as a modulation process for the offset, causing the magnetically-induced signal to recover its original spectrum at the baseband level, while the dc offset becomes a high-frequency signal. Then, using a low-pass filter, the signal passes while the modulated dc offset is suppressed.

The chopper stabilization technique uses a 170 kHz high-frequency clock. The Hall element chopping

occurs on each clock edge, resulting in a 340 kHz chop frequency. This high-frequency operation allows for a greater sampling rate, which produces higher accuracy and faster signal processing capability. This approach desensitizes the chip to the effects of thermal and mechanical stress. The disadvantage to this approach is that jitter, also known as *360° repeatability*, can be induced on the output signal. The *sample-and-hold* process, used by the demodulator to store and recover the signal, can slightly degrade the signal-to-noise ratio. This is because the process generates replicas of the noise spectrum at the baseband, causing a decrease in jitter performance. However, the improvement in switchpoint performance, resulting from the reduction of the effects of thermal and mechanical stress, outweighs the degradation in the signal-to-noise ratio.

This technique produces devices that have an extremely stable quiescent Hall element output voltage, are immune to thermal stress, and have precise recoverability after temperature cycling. This technique is made possible through the use of a BiCMOS process, which allows the use of low-offset and low-noise amplifiers in combination with high-density logic integration and sample-and-hold circuits. This process is illustrated in the following diagram.

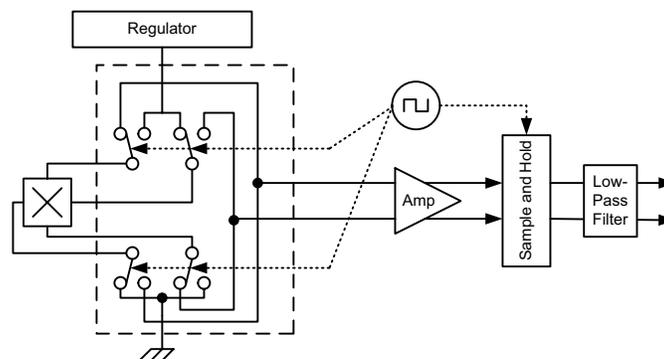

Chopper stabilization circuit (dynamic quadrature offset cancellation)

Typical Applications Operation

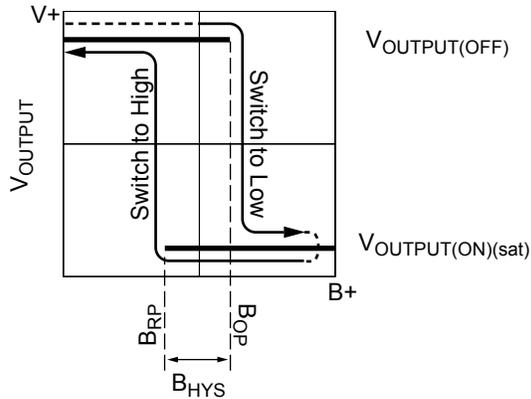

Output voltage in relation to sensed magnetic flux density. Output on each channel independently follows the same pattern of transition through B_{OP} followed by transition through B_{RP} .

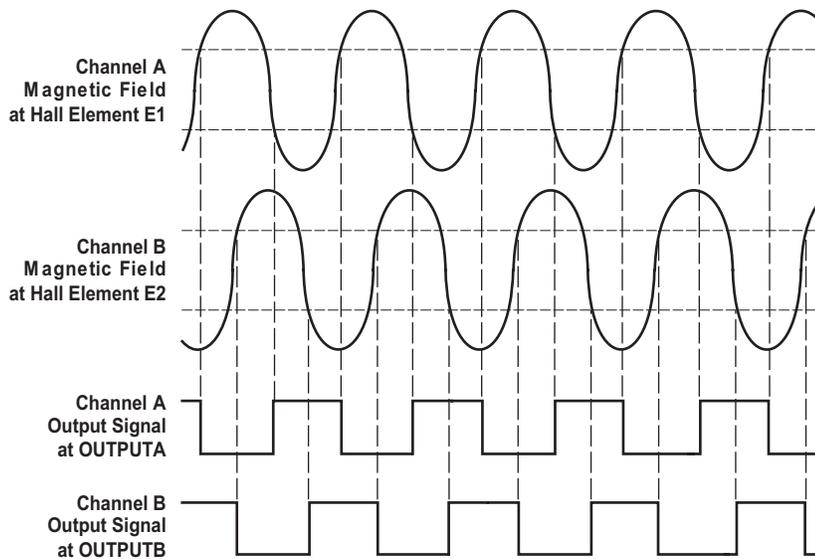

Quadrature output signal configuration. The outputs of the two output channels have a phase difference of 90° when used with a properly designed magnet that has an optimal pole pitch of twice the Hall element spacing of 1.0 mm.

Typical Applications Circuits

This device requires minimal protection circuitry during operation with a low-voltage regulated line. The on-chip voltage regulator provides immunity to power supply variations between 3.3 and 18 V. Because the device has open-drain outputs, pull-up resistors must be included.

If protection against coupled and injected noise is required, then a simple low-pass filter on the supply (RC) and a filtering capacitor on each of the outputs may also be needed, as shown in the unregulated supply diagram.

For applications in which the device receives its power from unregulated sources, such as a car battery, full

protection is generally required to protect the device against supply-side transients. Specifications for such transients vary for each application, so the design of the protection circuit should be optimized for each application.

For example, the circuit shown in the unregulated supply diagram includes a Zener diode that offers high voltage load-dump protection and noise filtering by means of a series resistor and capacitor. In addition, it includes a series diode that protects against high-voltage reverse battery conditions.

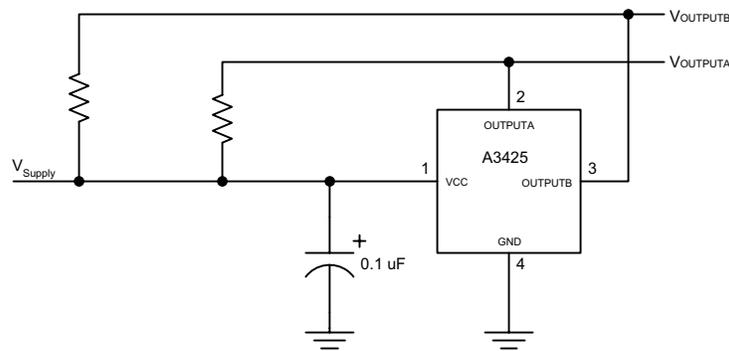

Regulated supply

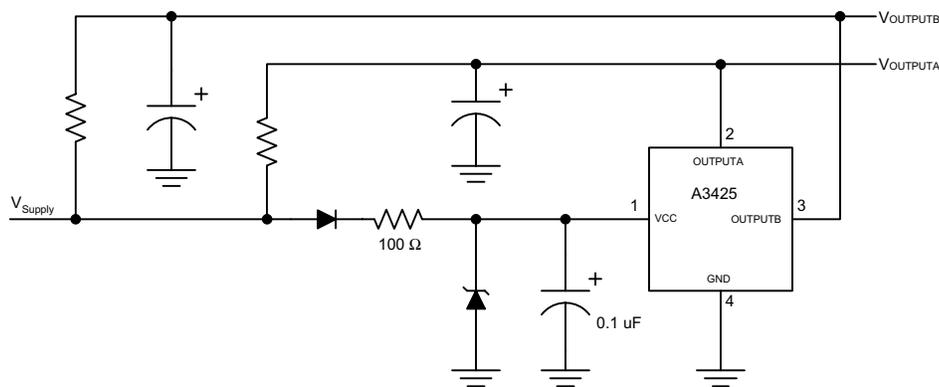

Unregulated supply

Typical Thermal Performance

The device must be operated below the maximum junction temperature of the device, $T_{J(max)}$. Under certain combinations of peak conditions, reliable operation may require derating supplied power or improving the heat dissipation properties of the application. This section presents a procedure for correlating factors affecting operating T_J . (Thermal data is also available on the Allegro MicroSystems Web site.)

The Package Thermal Resistance, $R_{\theta JA}$, is a figure of merit summarizing the ability of the application and the device to dissipate heat from the junction (die), through all paths to the ambient air. Its primary component is the Effective Thermal Conductivity, K , of the printed circuit board, including adjacent devices and traces. Radiation from the die through the device case, $R_{\theta JC}$, is relatively small component of $R_{\theta JA}$. Ambient air temperature, T_A , and air motion are significant external factors, damped by overmolding.

The effect of varying power levels (Power Dissipation, P_D), can be estimated. The following formulas represent the fundamental relationships used to estimate T_J , at P_D .

$$P_D = V_{IN} \times I_{IN} \quad (1)$$

$$\Delta T = P_D \times R_{\theta JA} \quad (2)$$

$$T_J = T_A + \Delta T \quad (3)$$

For example, given common conditions such as: $T_A = 25^\circ\text{C}$, $V_{CC} = 12\text{ V}$, $I_{CC} = 4\text{ mA}$, and $R_{\theta JA} = 140\text{ }^\circ\text{C/W}$, then:

$$P_D = V_{CC} \times I_{CC} = 12\text{ V} \times 4\text{ mA} = 48\text{ mW}$$

$$\Delta T = P_D \times R_{\theta JA} = 48\text{ mW} \times 140\text{ }^\circ\text{C/W} = 7^\circ\text{C}$$

$$T_J = T_A + \Delta T = 25^\circ\text{C} + 7^\circ\text{C} = 32^\circ\text{C}$$

A worst-case estimate, $P_{D(max)}$, represents the maximum allowable power level ($V_{CC(max)}$, $I_{CC(max)}$), without exceeding $T_{J(max)}$, at a selected $R_{\theta JA}$ and T_A .

Example: Reliability for V_{CC} at $T_A = 150^\circ\text{C}$, package L, using minimum-K PCB

Observe the worst-case ratings for the device, specifically: $R_{\theta JA} = 140\text{ }^\circ\text{C/W}$, $T_{J(max)} = 165^\circ\text{C}$, $V_{CC(max)} = 18\text{ V}$, and $I_{CC(max)} = 6\text{ mA}$.

Calculate the maximum allowable power level, $P_{D(max)}$. First, invert equation 3:

$$\Delta T_{max} = T_{J(max)} - T_A = 165^\circ\text{C} - 150^\circ\text{C} = 15^\circ\text{C}$$

This provides the allowable increase to T_J resulting from internal power dissipation. Then, invert equation 2:

$$P_{D(max)} = \Delta T_{max} \div R_{\theta JA} = 15^\circ\text{C} \div 140\text{ }^\circ\text{C/W} = 107\text{ mW}$$

Finally, invert equation 1 with respect to voltage:

$$V_{CC(est)} = P_{D(max)} \div I_{CC(max)} = 107\text{ mW} \div 6\text{ mA} = 18\text{ V}$$

The result indicates that, at T_A , the application and device can dissipate adequate amounts of heat at voltages $\leq V_{CC(est)}$.

Compare $V_{CC(est)}$ to $V_{CC(max)}$. If $V_{CC(est)} \leq V_{CC(max)}$, then reliable operation between $V_{CC(est)}$ and $V_{CC(max)}$ requires enhanced $R_{\theta JA}$. If $V_{CC(est)} \geq V_{CC(max)}$, then operation between $V_{CC(est)}$ and $V_{CC(max)}$ is reliable under these conditions.

Electrical Operating Characteristics, Package L

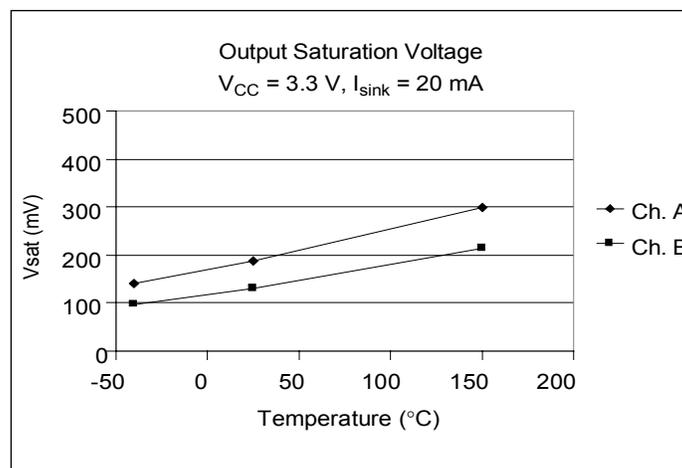
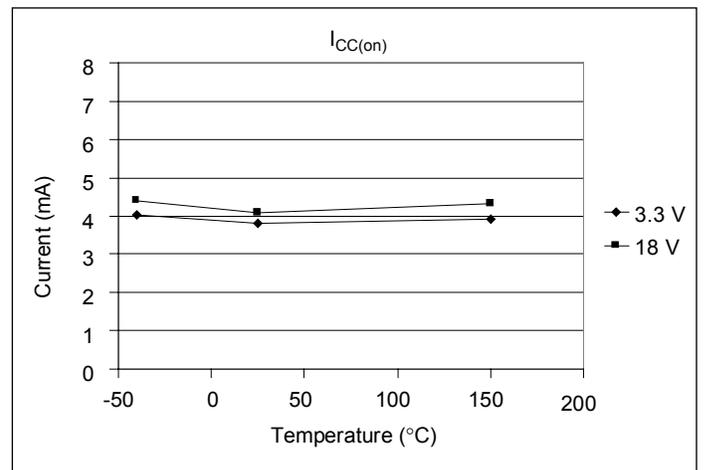
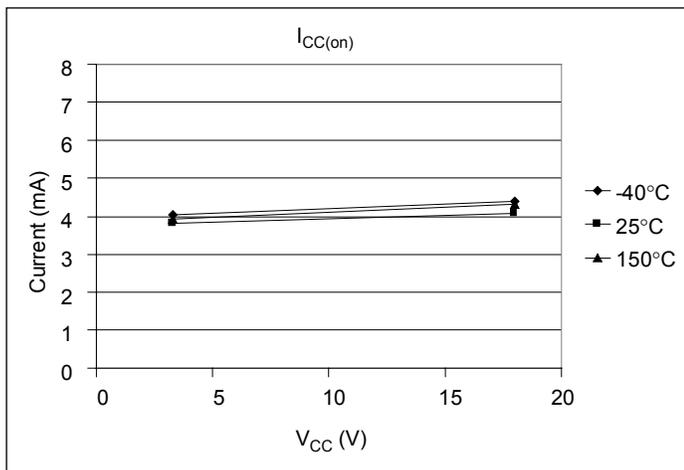
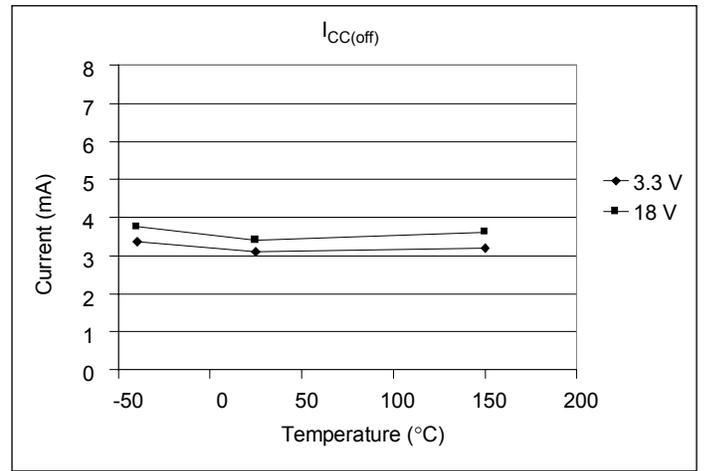
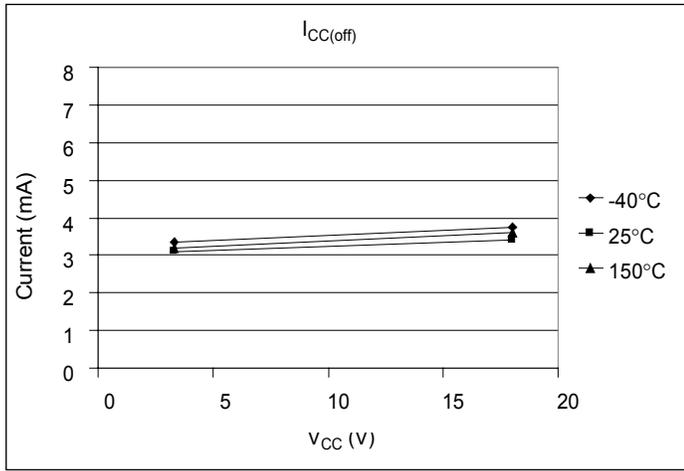

Magnetic Operating Characteristics, Package L

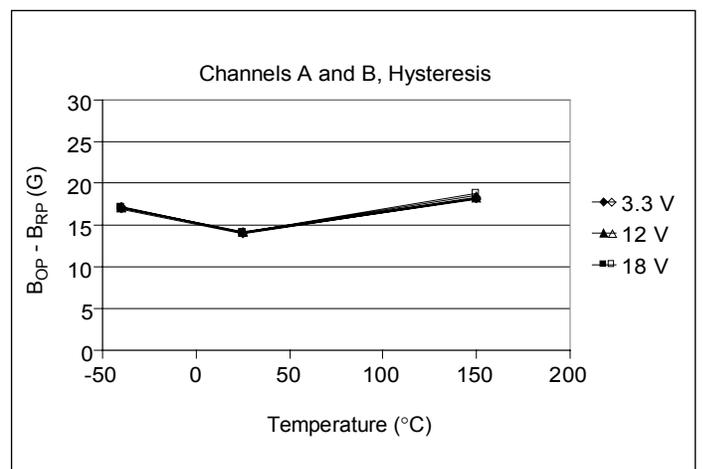
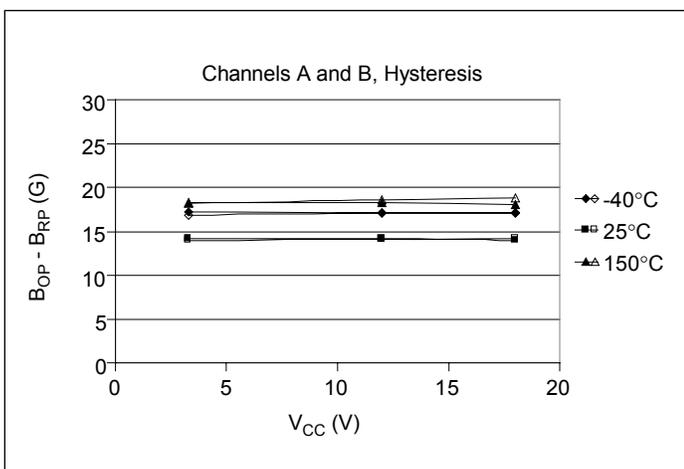
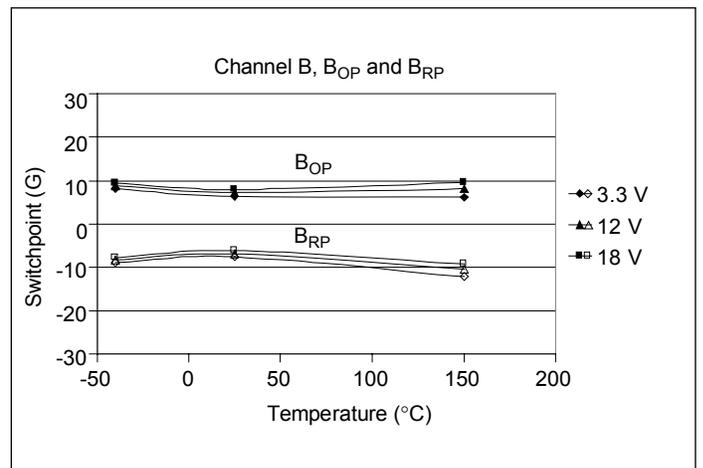
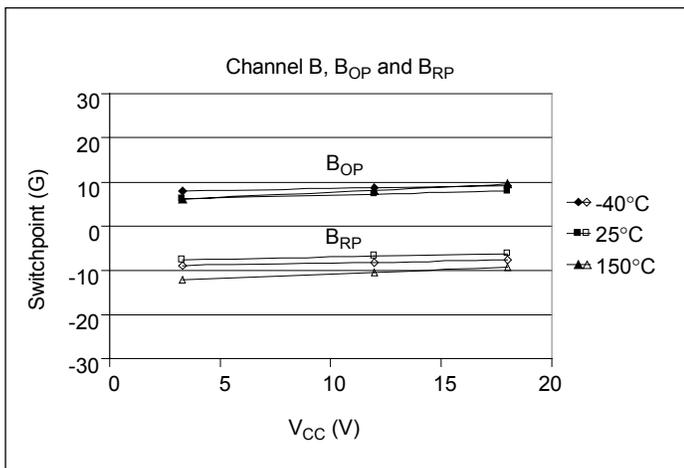
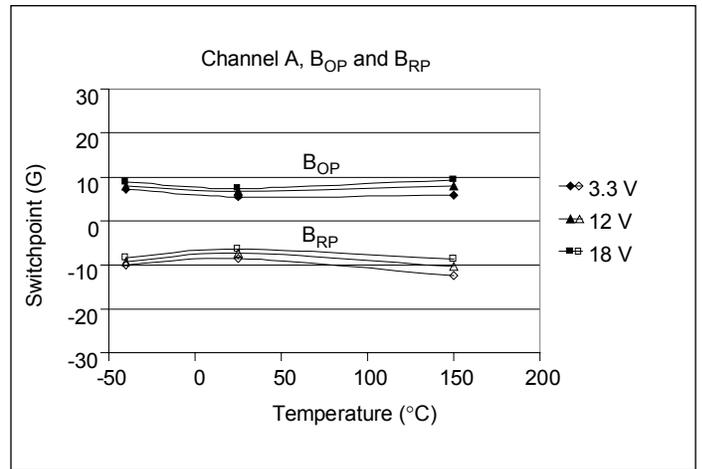
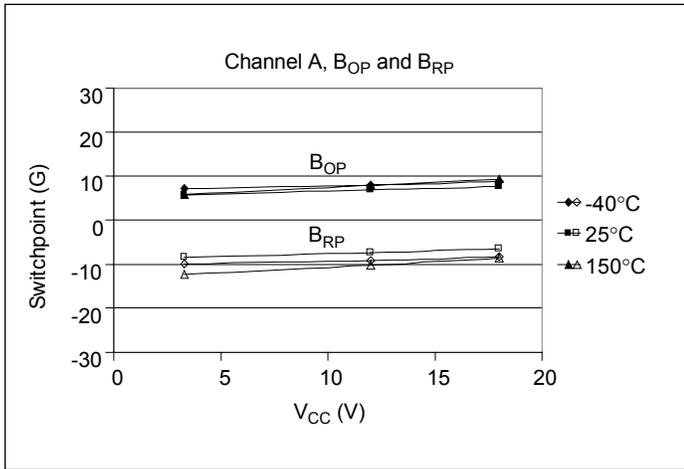

Additional magnetic characteristics on next page

Magnetic Operating Characteristics, Package L (continued)

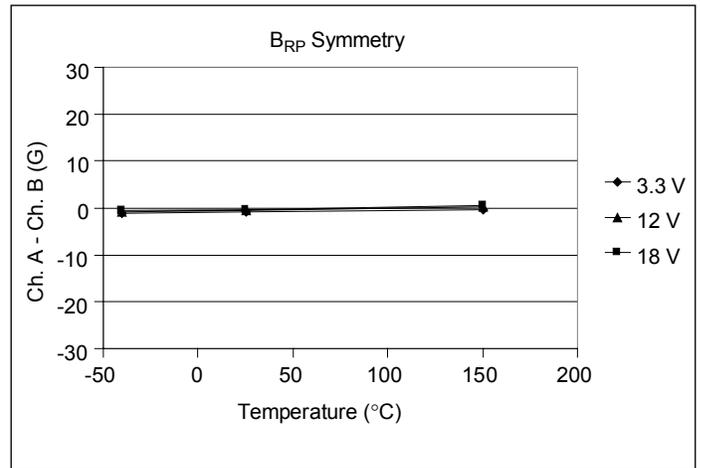
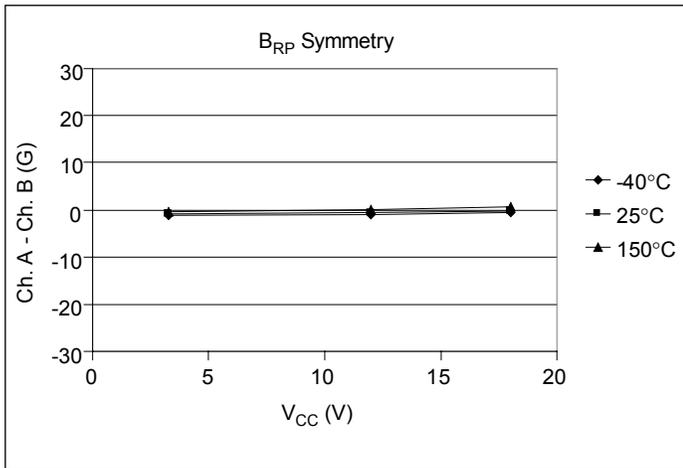
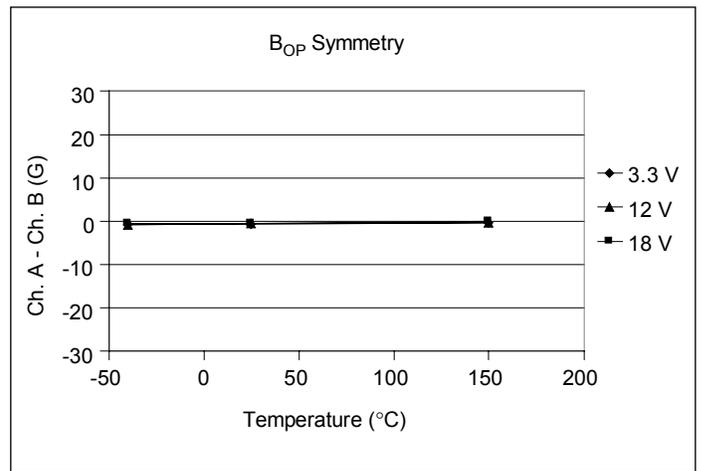
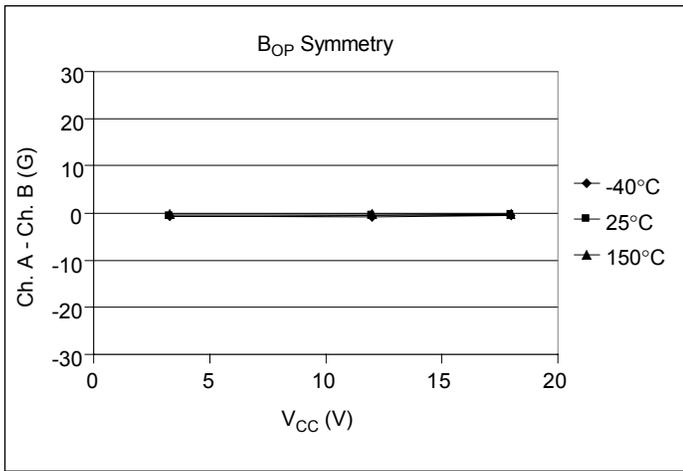

Additional magnetic characteristics on next page

Magnetic Operating Characteristics, Package L (continued)

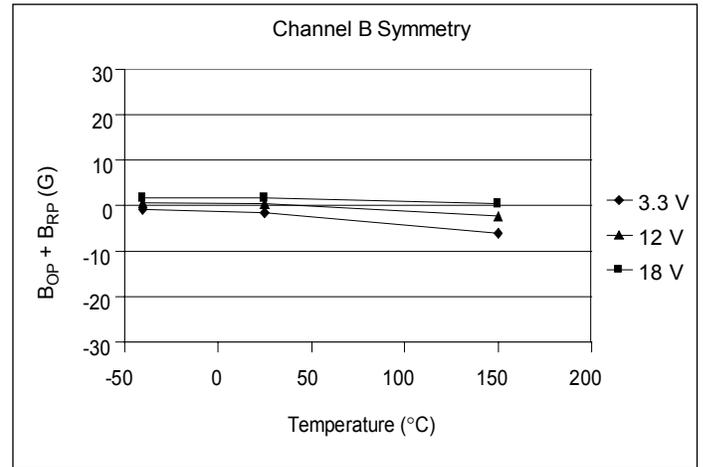
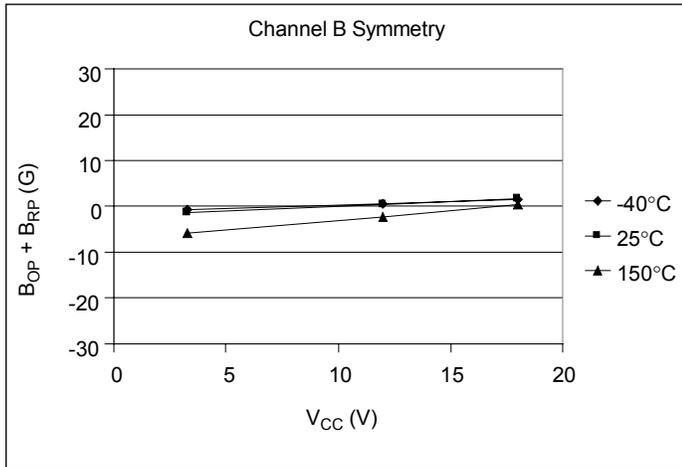
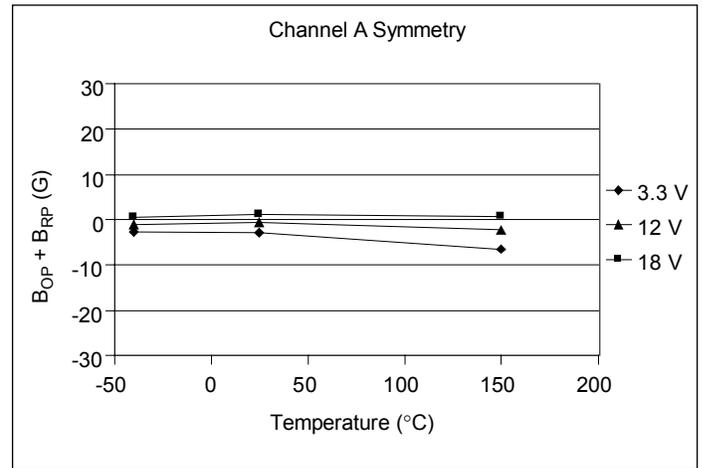
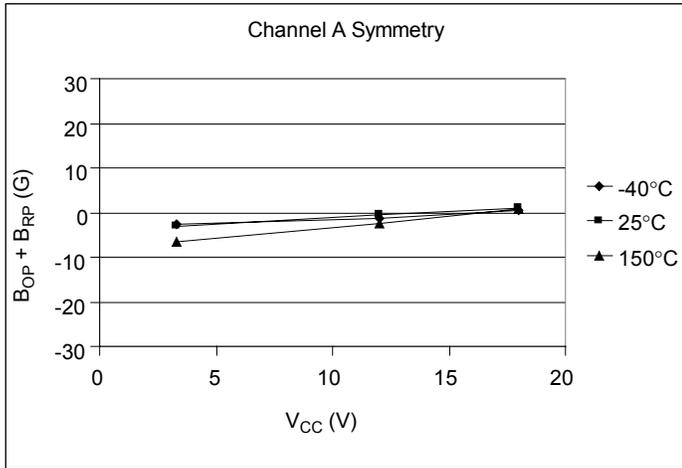

Electrical Operating Characteristics, Package K

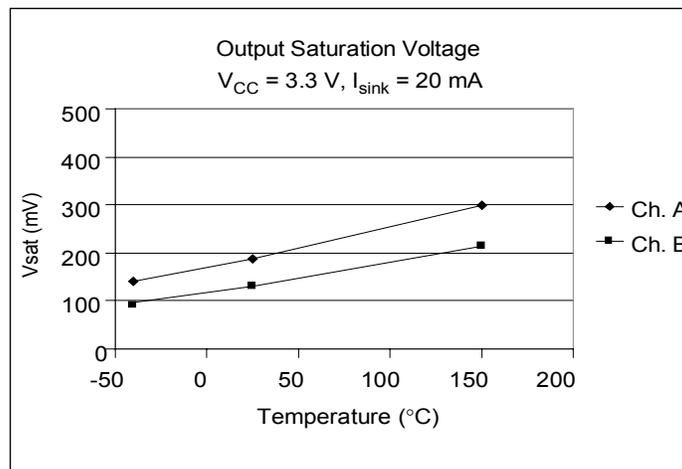
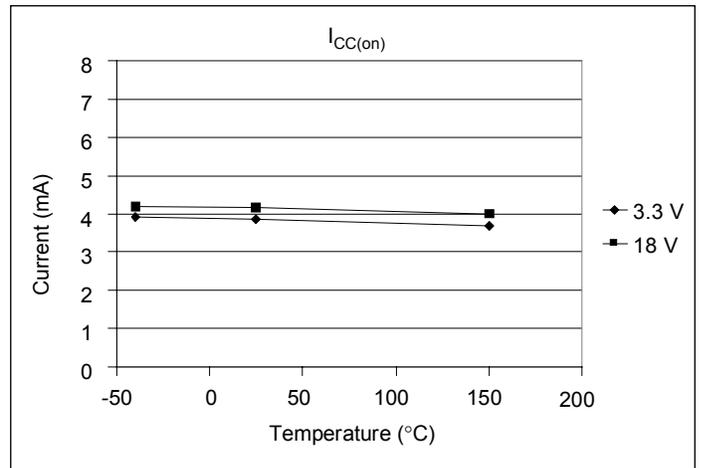
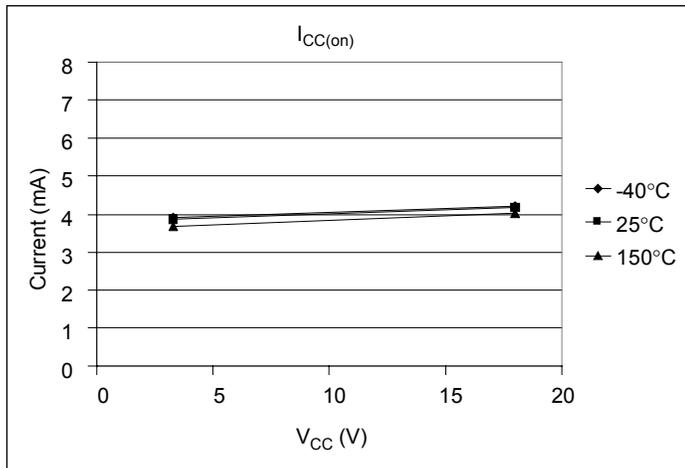
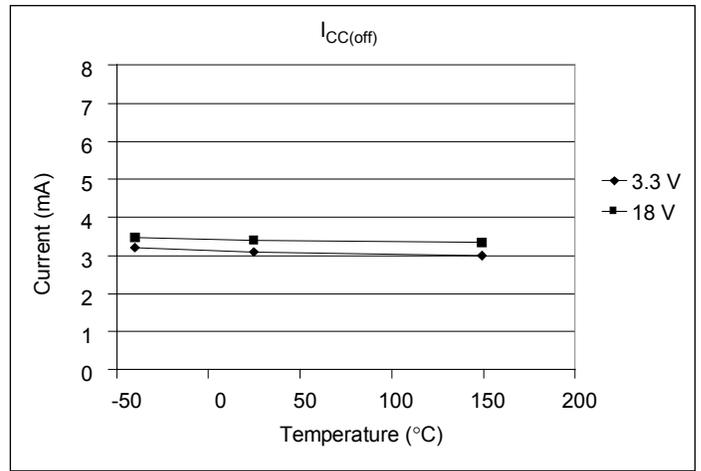
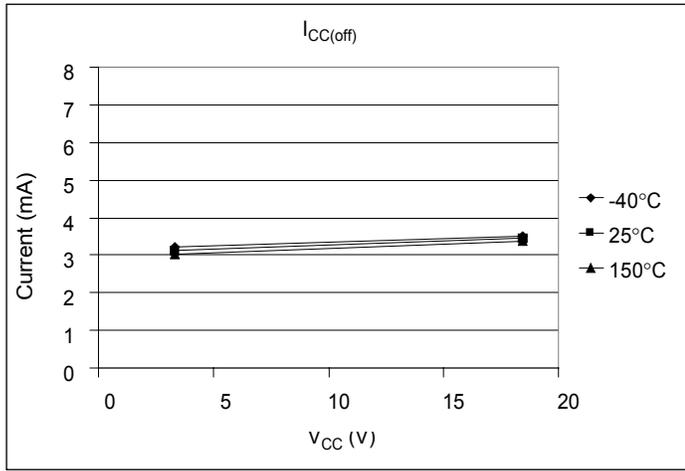

Magnetic Operating Characteristics, Package K

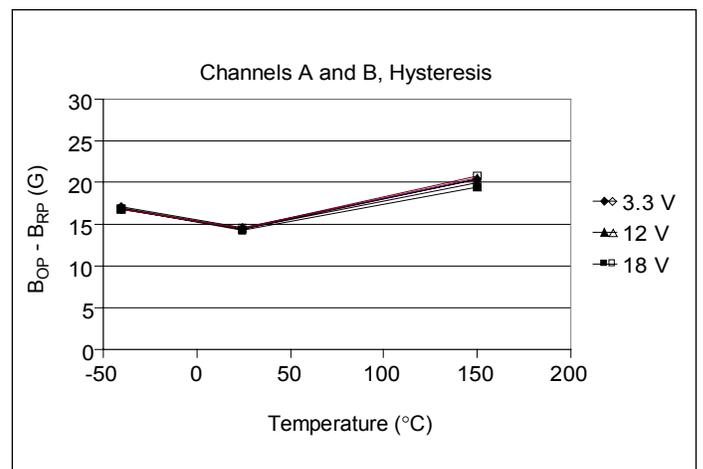
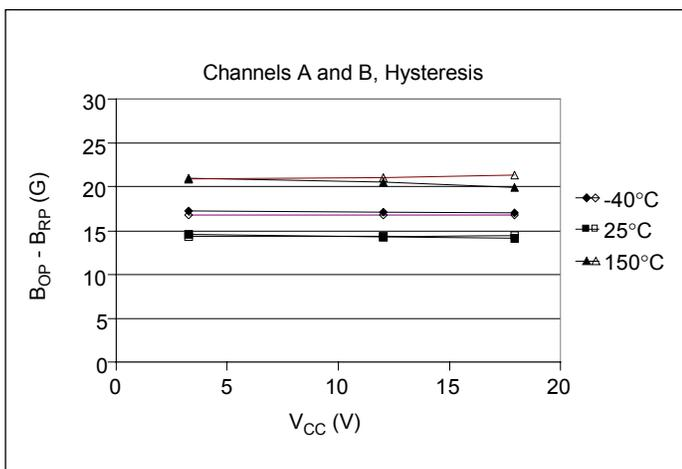
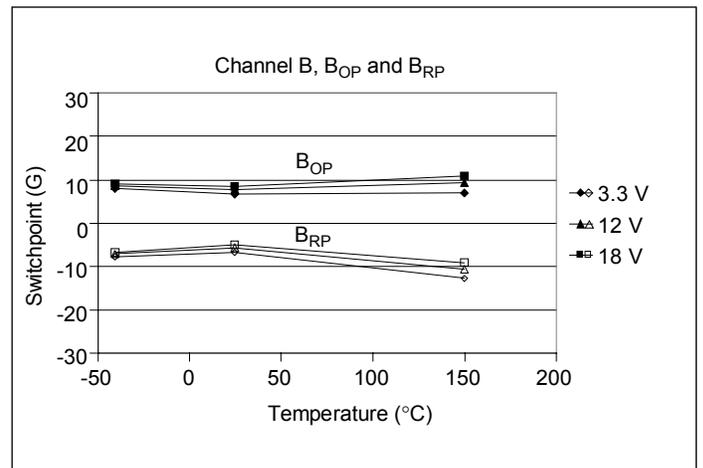
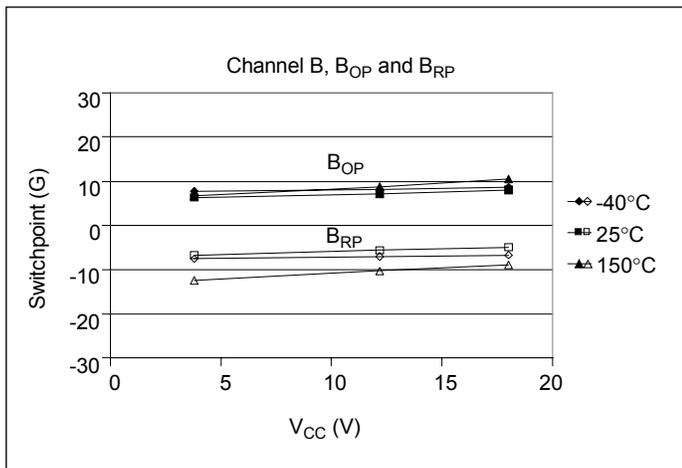
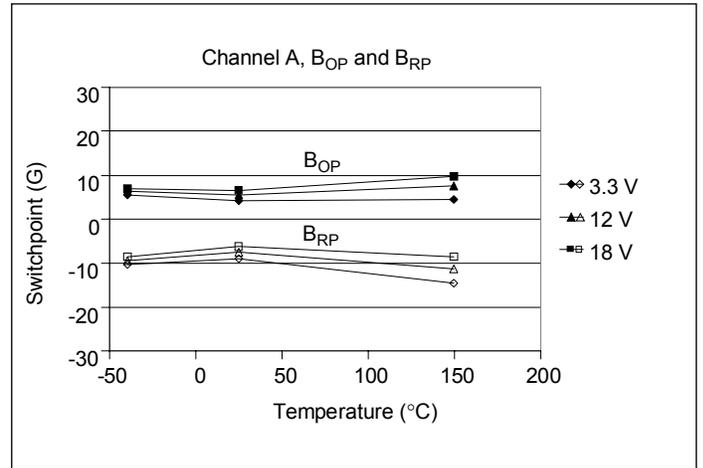
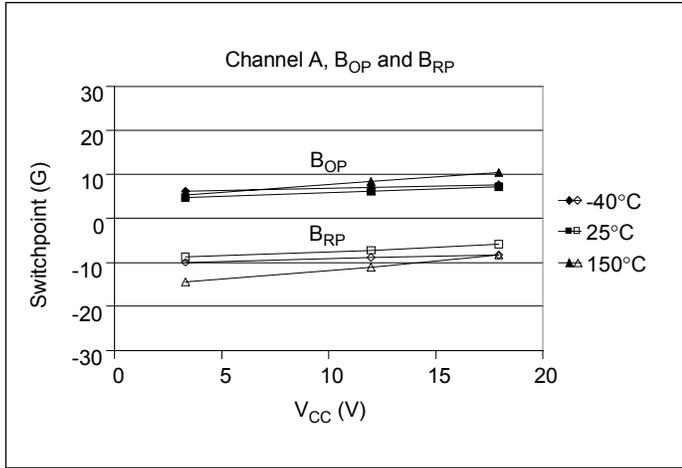

Additional magnetic characteristics on next page

Magnetic Operating Characteristics, Package K (continued)

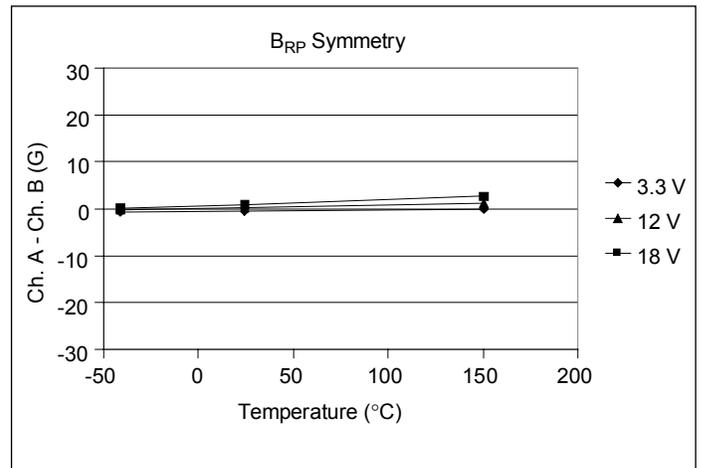
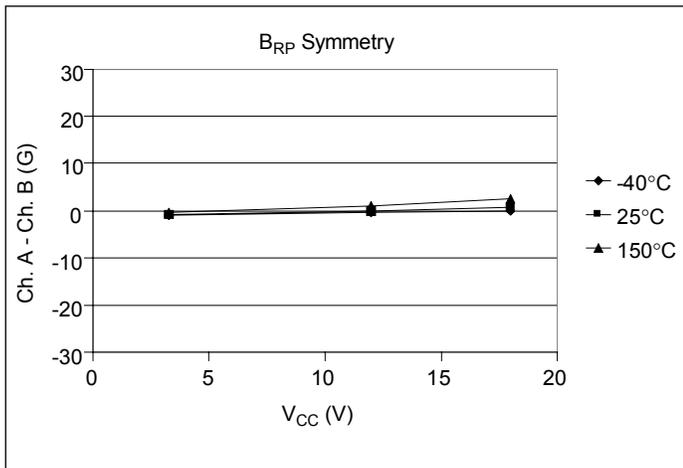
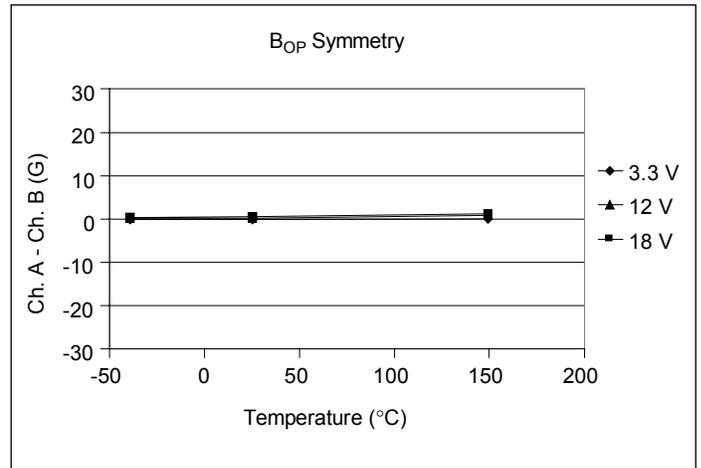
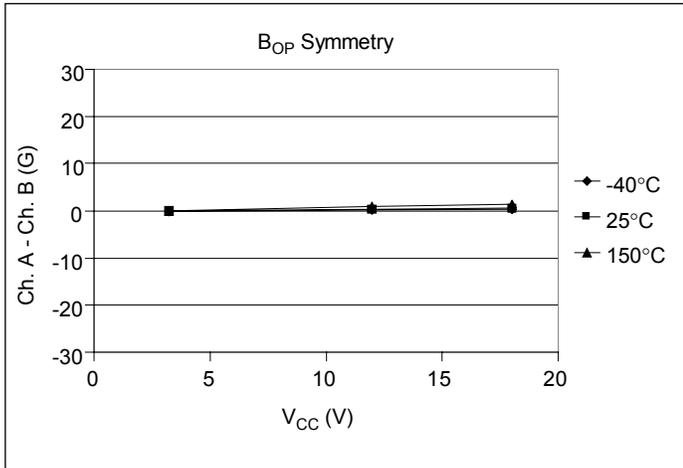

Additional magnetic characteristics on next page

Magnetic Operating Characteristics, Package K (continued)

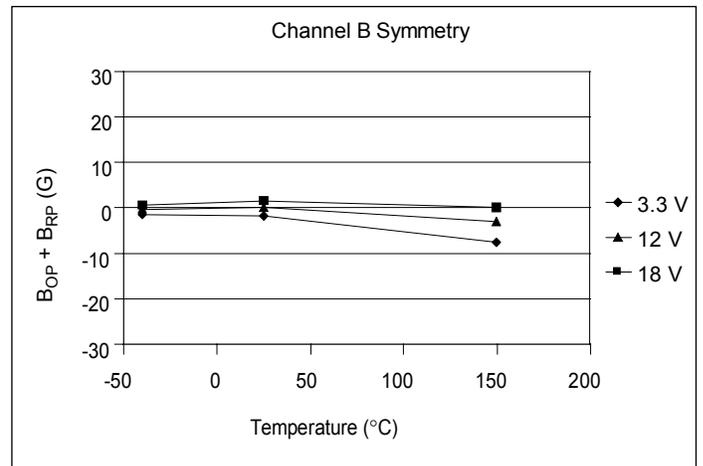
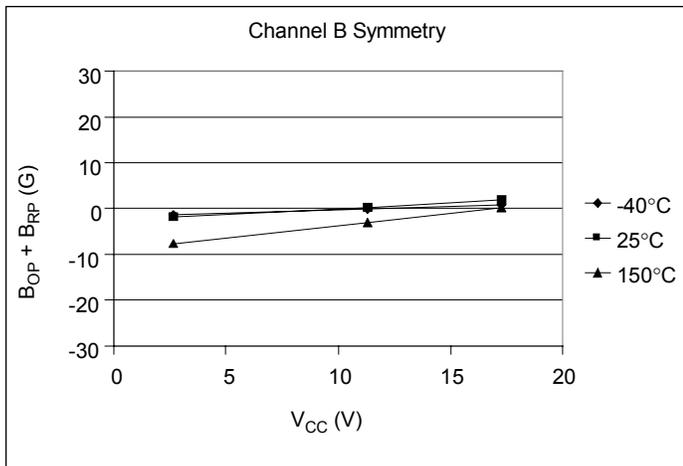
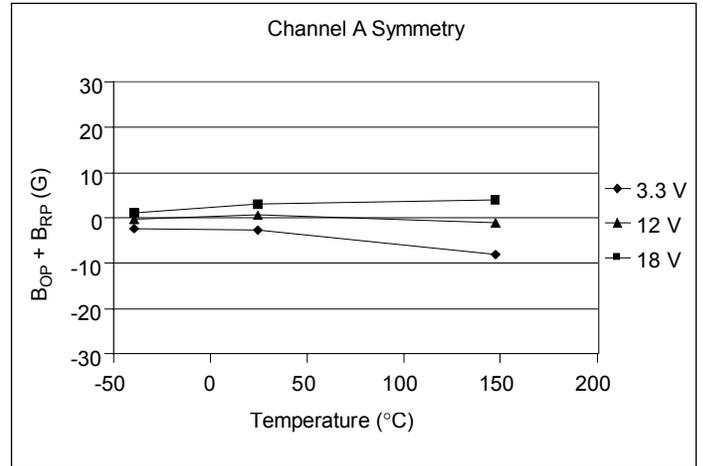
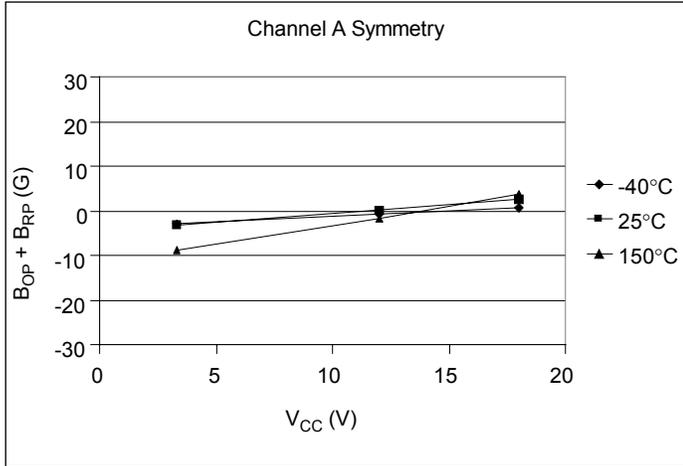

Package K, 4-pin SIP

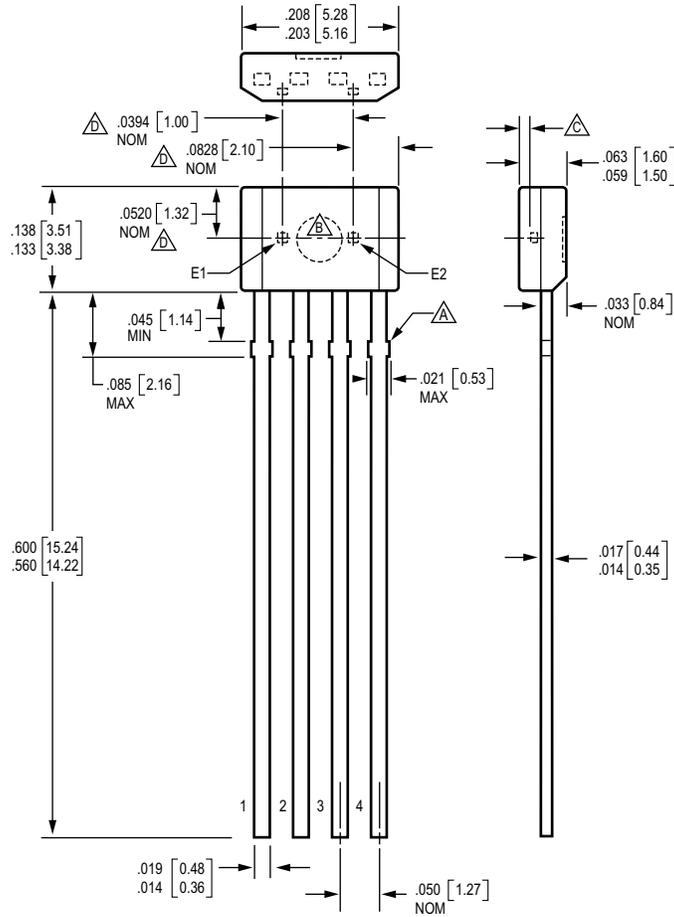

- Dimensions in inches
 Millimeters in brackets, for reference only
 Case dimensions exclusive of mold flash or gate burrs
 Mold flash .010 [0.25] MAX, gate burr .008 [0.20] MAX, dambar protrusion .004 [0.10] MAX
 Exact case and lead configuration at supplier discretion within limits shown
- Dambar removal protrusion (BX)
 - Ejector mark on opposite side
 - Active Area Depth .0165 [0.42] NOM
 - Hall elements E1, E2 (not to scale)

Ultra-Sensitive Dual-Channel Quadrature Hall-Effect Bipolar Switch

Package L, 8-pin SOIC

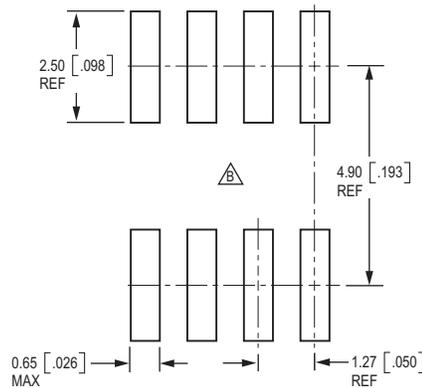
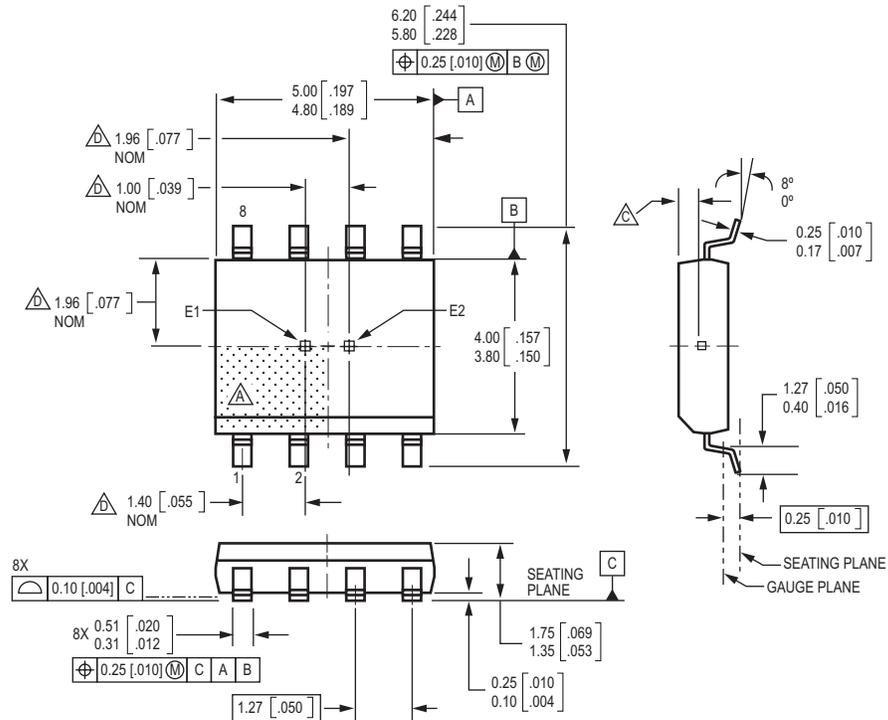

- Preliminary dimensions, for reference only
 Dimensions in millimeters
 U.S. Customary dimensions (in.) in brackets, for reference only
 (reference JEDEC MS-012 AA)
 Dimensions exclusive of mold flash, gate burrs, and dambar protrusions
 Exact case and lead configuration at supplier discretion within limits shown
- A Terminal #1 mark area
 - B Reference pad layout (reference IPC SOIC127P600-8M); adjust as necessary to meet application process requirements
 - C Active Area Depth 0.40 [0.016]
 - D Hall elements E1, E2 (not to scale), U.S. Customary dimensions controlling

The products described herein are manufactured under one or more of the following U.S. patents: 5,045,920; 5,264,783; 5,442,283; 5,389,889; 5,581,179; 5,517,112; 5,619,137; 5,621,319; 5,650,719; 5,686,894; 5,694,038; 5,729,130; 5,917,320; and other patents pending.

Allegro MicroSystems, Inc. reserves the right to make, from time to time, such departures from the detail specifications as may be required to permit improvements in the performance, reliability, or manufacturability of its products. Before placing an order, the user is cautioned to verify that the information being relied upon is current.

Allegro products are not authorized for use as critical components in life-support devices or systems without express written approval.

The information included herein is believed to be accurate and reliable. However, Allegro MicroSystems, Inc. assumes no responsibility for its use; nor for any infringement of patents or other rights of third parties which may result from its use.

Copyright © 2005, 2006, Allegro MicroSystems, Inc.