

# NFC Ferrite Antenna (13.56MHz)

ANFCA-3225-A02



RoHS/RoHS II compliant



32 x 25 mm

## Moisture Sensitivity Level (MSL) – MSL 1

### FEATURES:

- Ultra thin flexible antenna structure ( 220+/-46  $\mu$ m)
- Peel and Stick antenna designs
- Ferrite sheet backing optimizes magnetic fields
- Wide operating temperature range -40°C to +85°C
- Matched to leading NFC controller IC's
- Customized solutions available

### APPLICATIONS:

- Mobiles
- NFC Payment readers
- Electronic wallets
- Health care ID scanners
- NFC data loggers transport
- Ticketing systems
- Museum information systems
- Electronic Parking Payments
- Industrial data collection.

### STANDARD SPECIFICATIONS:

#### Maximum Ratings

Item	Value
Operating Temperature Range	-40°C to + 85°C
Storage Temperature Range	-40°C to + 85°C

Item	Spec
Operating Frequency (MHz)	13.56
Inductance ( $\mu$ H)	1.8 $\pm$ 10%
RAC ( $\Omega$ )	2.5 $\pm$ 20%
Test Condition	1 MHz/500mV

Test equipment: TH2828S.

#### Connection to the PCB

While soldering thin wires to the pads on the antenna is possible, great care must be taken, (see manual soldering Section 10.1). However it is recommended to make contact to the antenna pads via Pogo Pins. These are soldered onto the product PCB, and interface mechanically via a pressure contact to the pads on the NFC antenna. Volume applications using the NFC antenna should always use Pogo Pins to make the connections.

#### Product Customization

Products can be customized according to customer requirements. Features such as the dimensions or shape of the coil or its inductance can be customized. Please contact ABRACON or authorized distributor / agent for further details.

# NFC Ferrite Antenna (13.56MHz)

ANFCA-3225-A02



RoHS/RoHS II compliant

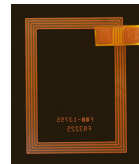

32 x 25 mm

## OUTLINE DIMENSIONS:

View from rear ferrite side, pads upward

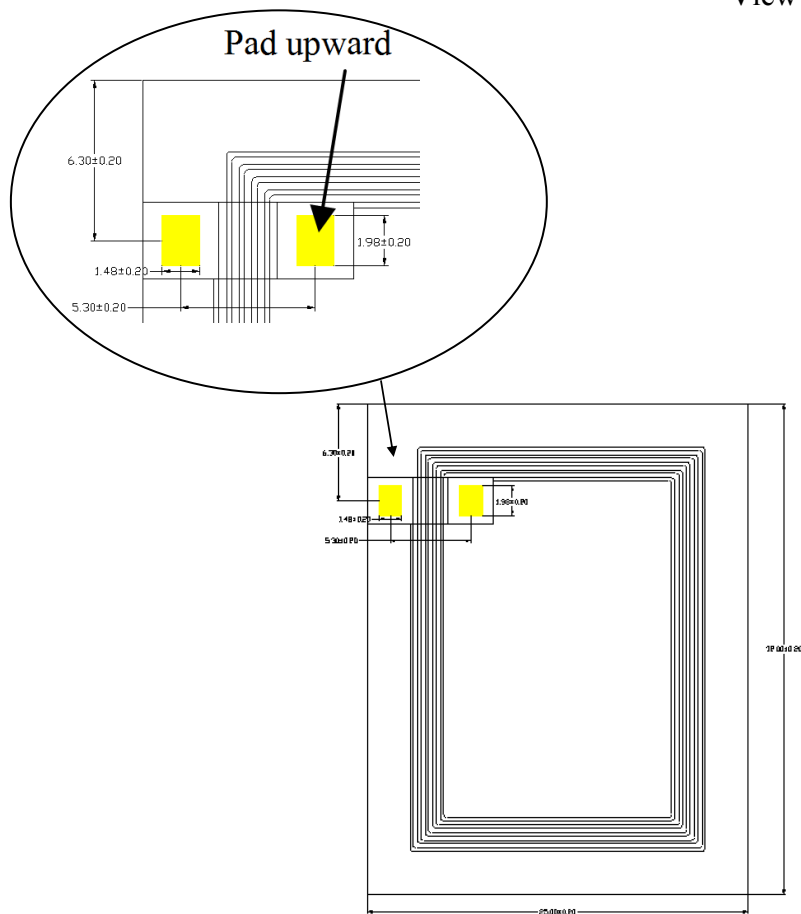

(Dimensions in mm)

## CONSTRUCTION:

No	Material Name	Thickness ( $\mu\text{m}$ )	Thickness (in)
1	PET Tape	10+/-3	0.000393±0.000118
2	Ferrite Sheet	100+/-5	0.00393±0.000196
3	Adhesive Tape	10+/-3	0.000393±0.000118
4	FCP	70+/-30	0.00275±0.000118
5	Adhesive Tape	30+/-5	0.00118±0.000196
6	Release Paper	/	/
Total Thickness		220+/-46	0.00866±0.00181

# NFC Ferrite Antenna (13.56MHz)

ANFCA-3225-A02



RoHS/RoHS II compliant



32 x 25 mm

## MATCHING CIRCUIT AND REFERENCE VALUES

Component	Value for reference only <sup>(1)</sup>	Notes
L0	560 / 330nH (NXP / Broadcom)	EMC filter resonance at 15.4MHz (NXP) and 20.6MHz (Broadcom).
C0	180pF	EMC filter resonance at 15.4MHz (NXP) and 20.6MHz (Broadcom).
C1	33pF	Antenna matching component, to achieve series resonance at 13.56MHz. (Note: Antenna matching component value may need optimization depending upon antenna environment)
C2 (Includes C2a and C2b values)	82pF	Antenna matching component, to achieve parallel resonance at 15MHz. (Note: Antenna matching component value may need optimization depending upon antenna environment).
Rq	0 Ohm	Damping resistor, the Rq resistor used to lower Q-value if above 35 Ohm, if needed.

Note (1) Values can change depending upon drive circuits, design of the antenna and environment.

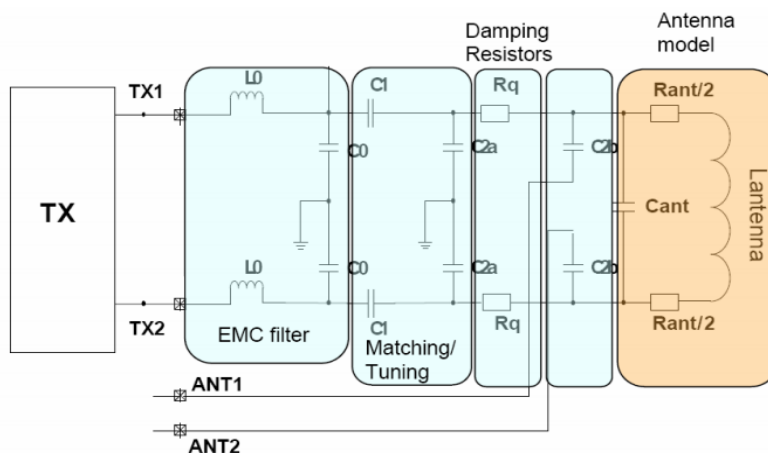

**Reflow Profile:** Not recommended for reflow soldering

**Manual Soldering:** Recommended Soldering iron temperature setting: 330°C, 3 seconds max, 3 times max.

**Packaging:** 100pcs per polyphene bag / box

**ATTENTION:** Abracon Corporation's products are COTS – Commercial-Off-The-Shelf products; suitable for Commercial, Industrial and, where designated, Automotive Applications. Abracon's products are not specifically designed for Military, Aviation, Aerospace, Life-dependant Medical applications or any application requiring high reliability where component failure could result in loss of life and/or property. For applications requiring high reliability and/or presenting an extreme operating environment, written consent and authorization from Abracon Corporation is required. Please contact Abracon Corporation for more information.

ABRACON IS  
ISO9001:2008  
CERTIFIED



2 Faraday, Suite# B | Irvine | CA 92618 **Revised:10.07.15**

Ph. 949.546.8000 | Fax. 949.546.8001

Visit [www.abracon.com](http://www.abracon.com) for Terms and Conditions of Sale