



**LUMINARY** MICRO™

---

# LM3S1138 Microcontroller

DATA SHEET

---

## Legal Disclaimers and Trademark Information

INFORMATION IN THIS DOCUMENT IS PROVIDED IN CONNECTION WITH LUMINARY MICRO PRODUCTS. NO LICENSE, EXPRESS OR IMPLIED, BY ESTOPPEL OR OTHERWISE, TO ANY INTELLECTUAL PROPERTY RIGHTS IS GRANTED BY THIS DOCUMENT. EXCEPT AS PROVIDED IN LUMINARY MICRO'S TERMS AND CONDITIONS OF SALE FOR SUCH PRODUCTS, LUMINARY MICRO ASSUMES NO LIABILITY WHATSOEVER, AND LUMINARY MICRO DISCLAIMS ANY EXPRESS OR IMPLIED WARRANTY, RELATING TO SALE AND/OR USE OF LUMINARY MICRO'S PRODUCTS INCLUDING LIABILITY OR WARRANTIES RELATING TO FITNESS FOR A PARTICULAR PURPOSE, MERCHANTABILITY, OR INFRINGEMENT OF ANY PATENT, COPYRIGHT OR OTHER INTELLECTUAL PROPERTY RIGHT. LUMINARY MICRO'S PRODUCTS ARE NOT INTENDED FOR USE IN MEDICAL, LIFE SAVING, OR LIFE-SUSTAINING APPLICATIONS.

Luminary Micro may make changes to specifications and product descriptions at any time, without notice. Contact your local Luminary Micro sales office or your distributor to obtain the latest specifications before placing your product order.

Designers must not rely on the absence or characteristics of any features or instructions marked "reserved" or "undefined." Luminary Micro reserves these for future definition and shall have no responsibility whatsoever for conflicts or incompatibilities arising from future changes to them.

Copyright © 2007 Luminary Micro, Inc. All rights reserved. Stellaris is a registered trademark and Luminary Micro and the Luminary Micro logo are trademarks of Luminary Micro, Inc. or its subsidiaries in the United States and other countries. ARM and Thumb are registered trademarks and Cortex is a trademark of ARM Limited. Other names and brands may be claimed as the property of others.

Luminary Micro, Inc.  
108 Wild Basin, Suite 350  
Austin, TX 78746  
Main: +1-512-279-8800  
Fax: +1-512-279-8879  
<http://www.luminarymicro.com>



LUMINARY MICRO™



# Table of Contents

<b>About This Document .....</b>	<b>18</b>
Audience .....	18
About This Manual .....	18
Related Documents .....	18
Documentation Conventions .....	18
<b>1 Architectural Overview .....</b>	<b>20</b>
1.1 Product Features .....	20
1.2 Target Applications .....	25
1.3 High-Level Block Diagram .....	25
1.4 Functional Overview .....	26
1.4.1 ARM Cortex™-M3 .....	27
1.4.2 Motor Control Peripherals .....	27
1.4.3 Analog Peripherals .....	28
1.4.4 Serial Communications Peripherals .....	28
1.4.5 System Peripherals .....	30
1.4.6 Memory Peripherals .....	30
1.4.7 Additional Features .....	31
1.4.8 Hardware Details .....	32
<b>2 ARM Cortex-M3 Processor Core .....</b>	<b>33</b>
2.1 Block Diagram .....	34
2.2 Functional Description .....	34
2.2.1 Serial Wire and JTAG Debug .....	34
2.2.2 Embedded Trace Macrocell (ETM) .....	35
2.2.3 Trace Port Interface Unit (TPIU) .....	35
2.2.4 ROM Table .....	35
2.2.5 Memory Protection Unit (MPU) .....	35
2.2.6 Nested Vectored Interrupt Controller (NVIC) .....	35
<b>3 Memory Map .....</b>	<b>39</b>
<b>4 Interrupts .....</b>	<b>41</b>
<b>5 JTAG Interface .....</b>	<b>44</b>
5.1 Block Diagram .....	45
5.2 Functional Description .....	45
5.2.1 JTAG Interface Pins .....	46
5.2.2 JTAG TAP Controller .....	47
5.2.3 Shift Registers .....	48
5.2.4 Operational Considerations .....	48
5.3 Initialization and Configuration .....	51
5.4 Register Descriptions .....	51
5.4.1 Instruction Register (IR) .....	51
5.4.2 Data Registers .....	53
<b>6 System Control .....</b>	<b>55</b>
6.1 Functional Description .....	55
6.1.1 Device Identification .....	55
6.1.2 Reset Control .....	55

6.1.3	Power Control .....	58
6.1.4	Clock Control .....	58
6.1.5	System Control .....	60
6.2	Initialization and Configuration .....	61
6.3	Register Map .....	61
6.4	Register Descriptions .....	62
<b>7</b>	<b>Hibernation Module .....</b>	<b>114</b>
7.1	Block Diagram .....	115
7.2	Functional Description .....	115
7.2.1	Register Access Timing .....	115
7.2.2	Clock Source .....	116
7.2.3	Battery Management .....	116
7.2.4	Real-Time Clock .....	116
7.2.5	Non-Volatile Memory .....	117
7.2.6	Power Control .....	117
7.2.7	Interrupts and Status .....	117
7.3	Initialization and Configuration .....	118
7.3.1	Initialization .....	118
7.3.2	RTC Match Functionality (No Hibernation) .....	118
7.3.3	RTC Match/Wake-Up from Hibernation .....	118
7.3.4	External Wake-Up from Hibernation .....	119
7.3.5	RTC/External Wake-Up from Hibernation .....	119
7.4	Register Map .....	119
7.5	Register Descriptions .....	120
<b>8</b>	<b>Internal Memory .....</b>	<b>133</b>
8.1	Block Diagram .....	133
8.2	Functional Description .....	133
8.2.1	SRAM Memory .....	133
8.2.2	Flash Memory .....	134
8.3	Flash Memory Initialization and Configuration .....	135
8.3.1	Flash Programming .....	135
8.3.2	Nonvolatile Register Programming .....	136
8.4	Register Map .....	136
8.5	Flash Register Descriptions (Flash Control Offset) .....	137
8.6	Flash Register Descriptions (System Control Offset) .....	144
<b>9</b>	<b>General-Purpose Input/Outputs (GPIOs) .....</b>	<b>157</b>
9.1	Functional Description .....	157
9.1.1	Data Control .....	157
9.1.2	Interrupt Control .....	158
9.1.3	Mode Control .....	159
9.1.4	Commit Control .....	159
9.1.5	Pad Control .....	159
9.1.6	Identification .....	160
9.2	Initialization and Configuration .....	160
9.3	Register Map .....	161
9.4	Register Descriptions .....	163

<b>10</b>	<b>General-Purpose Timers</b> .....	<b>198</b>
10.1	Block Diagram .....	199
10.2	Functional Description .....	199
10.2.1	GPTM Reset Conditions .....	199
10.2.2	32-Bit Timer Operating Modes .....	199
10.2.3	16-Bit Timer Operating Modes .....	201
10.3	Initialization and Configuration .....	205
10.3.1	32-Bit One-Shot/Periodic Timer Mode .....	205
10.3.2	32-Bit Real-Time Clock (RTC) Mode .....	206
10.3.3	16-Bit One-Shot/Periodic Timer Mode .....	206
10.3.4	16-Bit Input Edge Count Mode .....	207
10.3.5	16-Bit Input Edge Timing Mode .....	207
10.3.6	16-Bit PWM Mode .....	208
10.4	Register Map .....	208
10.5	Register Descriptions .....	209
<b>11</b>	<b>Watchdog Timer</b> .....	<b>234</b>
11.1	Block Diagram .....	234
11.2	Functional Description .....	234
11.3	Initialization and Configuration .....	235
11.4	Register Map .....	235
11.5	Register Descriptions .....	236
<b>12</b>	<b>Analog-to-Digital Converter (ADC)</b> .....	<b>257</b>
12.1	Block Diagram .....	258
12.2	Functional Description .....	258
12.2.1	Sample Sequencers .....	258
12.2.2	Module Control .....	259
12.2.3	Hardware Sample Averaging Circuit .....	260
12.2.4	Analog-to-Digital Converter .....	260
12.2.5	Test Modes .....	260
12.2.6	Internal Temperature Sensor .....	260
12.3	Initialization and Configuration .....	261
12.3.1	Module Initialization .....	261
12.3.2	Sample Sequencer Configuration .....	261
12.4	Register Map .....	262
12.5	Register Descriptions .....	263
<b>13</b>	<b>Universal Asynchronous Receivers/Transmitters (UARTs)</b> .....	<b>290</b>
13.1	Block Diagram .....	291
13.2	Functional Description .....	291
13.2.1	Transmit/Receive Logic .....	291
13.2.2	Baud-Rate Generation .....	292
13.2.3	Data Transmission .....	293
13.2.4	Serial IR (SIR) .....	293
13.2.5	FIFO Operation .....	294
13.2.6	Interrupts .....	294
13.2.7	Loopback Operation .....	295
13.2.8	IrDA SIR block .....	295
13.3	Initialization and Configuration .....	295
13.4	Register Map .....	296

13.5	Register Descriptions .....	297
<b>14</b>	<b>Synchronous Serial Interface (SSI) .....</b>	<b>331</b>
14.1	Block Diagram .....	331
14.2	Functional Description .....	331
14.2.1	Bit Rate Generation .....	332
14.2.2	FIFO Operation .....	332
14.2.3	Interrupts .....	332
14.2.4	Frame Formats .....	333
14.3	Initialization and Configuration .....	340
14.4	Register Map .....	341
14.5	Register Descriptions .....	342
<b>15</b>	<b>Inter-Integrated Circuit (I<sup>2</sup>C) Interface .....</b>	<b>368</b>
15.1	Block Diagram .....	368
15.2	Functional Description .....	368
15.2.1	I <sup>2</sup> C Bus Functional Overview .....	369
15.2.2	Available Speed Modes .....	371
15.2.3	Interrupts .....	372
15.2.4	Loopback Operation .....	372
15.2.5	Command Sequence Flow Charts .....	372
15.3	Initialization and Configuration .....	379
15.4	I <sup>2</sup> C Register Map .....	380
15.5	Register Descriptions (I <sup>2</sup> C Master) .....	381
15.6	Register Descriptions (I2C Slave) .....	394
<b>16</b>	<b>Analog Comparators .....</b>	<b>403</b>
16.1	Block Diagram .....	404
16.2	Functional Description .....	404
16.2.1	Internal Reference Programming .....	406
16.3	Initialization and Configuration .....	407
16.4	Register Map .....	407
16.5	Register Descriptions .....	408
<b>17</b>	<b>Pin Diagram .....</b>	<b>416</b>
<b>18</b>	<b>Signal Tables .....</b>	<b>417</b>
<b>19</b>	<b>Operating Characteristics .....</b>	<b>431</b>
<b>20</b>	<b>Electrical Characteristics .....</b>	<b>432</b>
20.1	DC Characteristics .....	432
20.1.1	Maximum Ratings .....	432
20.1.2	Recommended DC Operating Conditions .....	432
20.1.3	On-Chip Low Drop-Out (LDO) Regulator Characteristics .....	433
20.1.4	Power Specifications .....	433
20.1.5	Flash Memory Characteristics .....	433
20.2	AC Characteristics .....	434
20.2.1	Load Conditions .....	434
20.2.2	Clocks .....	434
20.2.3	Analog-to-Digital Converter .....	435
20.2.4	Analog Comparator .....	435
20.2.5	I <sup>2</sup> C .....	436

---

20.2.6	Hibernation Module .....	436
20.2.7	Synchronous Serial Interface (SSI) .....	437
20.2.8	JTAG and Boundary Scan .....	439
20.2.9	General-Purpose I/O .....	440
20.2.10	Reset .....	441
<b>21</b>	<b>Package Information .....</b>	<b>443</b>
<b>A</b>	<b>Serial Flash Loader .....</b>	<b>445</b>
A.1	Serial Flash Loader .....	445
A.2	Interfaces .....	445
A.2.1	UART .....	445
A.2.2	SSI .....	445
A.3	Packet Handling .....	446
A.3.1	Packet Format .....	446
A.3.2	Sending Packets .....	446
A.3.3	Receiving Packets .....	446
A.4	Commands .....	447
A.4.1	COMMAND_PING (0X20) .....	447
A.4.2	COMMAND_GET_STATUS (0x23) .....	447
A.4.3	COMMAND_DOWNLOAD (0x21) .....	447
A.4.4	COMMAND_SEND_DATA (0x24) .....	448
A.4.5	COMMAND_RUN (0x22) .....	448
A.4.6	COMMAND_RESET (0x25) .....	448
<b>B</b>	<b>Register Quick Reference .....</b>	<b>450</b>
<b>C</b>	<b>Ordering and Contact Information .....</b>	<b>465</b>
C.1	Ordering Information .....	465
C.2	Company Information .....	465
C.3	Support Information .....	465

## List of Figures

Figure 1-1.	Stellaris® Fury-class Family High-Level Block Diagram .....	26
Figure 2-1.	CPU Block Diagram .....	34
Figure 2-2.	TPIU Block Diagram .....	35
Figure 5-1.	JTAG Module Block Diagram .....	45
Figure 5-2.	Test Access Port State Machine .....	48
Figure 5-3.	IDCODE Register Format .....	53
Figure 5-4.	BYPASS Register Format .....	54
Figure 5-5.	Boundary Scan Register Format .....	54
Figure 6-1.	External Circuitry to Extend Reset .....	56
Figure 7-1.	Hibernation Module Block Diagram .....	115
Figure 8-1.	Flash Block Diagram .....	133
Figure 9-1.	GPIO DATA Write Example .....	158
Figure 9-2.	GPIO DATA Read Example .....	158
Figure 10-1.	GPTM Module Block Diagram .....	199
Figure 10-2.	16-Bit Input Edge Count Mode Example .....	203
Figure 10-3.	16-Bit Input Edge Time Mode Example .....	204
Figure 10-4.	16-Bit PWM Mode Example .....	205
Figure 11-1.	WDT Module Block Diagram .....	234
Figure 12-1.	ADC Module Block Diagram .....	258
Figure 12-2.	Internal Temperature Sensor Characteristic .....	261
Figure 13-1.	UART Module Block Diagram .....	291
Figure 13-2.	UART Character Frame .....	292
Figure 13-3.	IrDA Data Modulation .....	294
Figure 14-1.	SSI Module Block Diagram .....	331
Figure 14-2.	TI Synchronous Serial Frame Format (Single Transfer) .....	333
Figure 14-3.	TI Synchronous Serial Frame Format (Continuous Transfer) .....	334
Figure 14-4.	Freescal e SPI Format (Single Transfer) with SPO=0 and SPH=0 .....	335
Figure 14-5.	Freescal e SPI Format (Continuous Transfer) with SPO=0 and SPH=0 .....	335
Figure 14-6.	Freescal e SPI Frame Format with SPO=0 and SPH=1 .....	336
Figure 14-7.	Freescal e SPI Frame Format (Single Transfer) with SPO=1 and SPH=0 .....	337
Figure 14-8.	Freescal e SPI Frame Format (Continuous Transfer) with SPO=1 and SPH=0 .....	337
Figure 14-9.	Freescal e SPI Frame Format with SPO=1 and SPH=1 .....	338
Figure 14-10.	MICROWIRE Frame Format (Single Frame) .....	339
Figure 14-11.	MICROWIRE Frame Format (Continuous Transfer) .....	340
Figure 14-12.	MICROWIRE Frame Format, SSIFss Input Setup and Hold Requirements .....	340
Figure 15-1.	I <sup>2</sup> C Block Diagram .....	368
Figure 15-2.	I <sup>2</sup> C Bus Configuration .....	369
Figure 15-3.	START and STOP Conditions .....	369
Figure 15-4.	Complete Data Transfer with a 7-Bit Address .....	370
Figure 15-5.	R/S Bit in First Byte .....	370
Figure 15-6.	Data Validity During Bit Transfer on the I <sup>2</sup> C Bus .....	370
Figure 15-7.	Master Single SEND .....	373
Figure 15-8.	Master Single RECEIVE .....	374
Figure 15-9.	Master Burst SEND .....	375
Figure 15-10.	Master Burst RECEIVE .....	376
Figure 15-11.	Master Burst RECEIVE after Burst SEND .....	377



---

Figure 15-12. Master Burst SEND after Burst RECEIVE .....	378
Figure 15-13. Slave Command Sequence .....	379
Figure 16-1. Analog Comparator Module Block Diagram .....	404
Figure 16-2. Structure of Comparator Unit .....	405
Figure 16-3. Comparator Internal Reference Structure .....	406
Figure 17-1. Pin Connection Diagram .....	416
Figure 20-1. Load Conditions .....	434
Figure 20-2. I <sup>2</sup> C Timing .....	436
Figure 20-3. Hibernation Module Timing .....	437
Figure 20-4. SSI Timing for TI Frame Format (FRF=01), Single Transfer Timing Measurement .....	438
Figure 20-5. SSI Timing for MICROWIRE Frame Format (FRF=10), Single Transfer .....	438
Figure 20-6. SSI Timing for SPI Frame Format (FRF=00), with SPH=1 .....	439
Figure 20-7. JTAG Test Clock Input Timing .....	440
Figure 20-8. JTAG Test Access Port (TAP) Timing .....	440
Figure 20-9. JTAG TRST Timing .....	440
Figure 20-10. External Reset Timing ( $\overline{\text{RST}}$ ) .....	441
Figure 20-11. Power-On Reset Timing .....	442
Figure 20-12. Brown-Out Reset Timing .....	442
Figure 20-13. Software Reset Timing .....	442
Figure 20-14. Watchdog Reset Timing .....	442
Figure 21-1. 100-Pin LQFP Package .....	443

## List of Tables

Table 1.	Documentation Conventions .....	18
Table 3-1.	Memory Map .....	39
Table 4-1.	Exception Types .....	41
Table 4-2.	Interrupts .....	42
Table 5-1.	JTAG Port Pins Reset State .....	46
Table 5-2.	JTAG Instruction Register Commands .....	51
Table 6-1.	System Control Register Map .....	61
Table 7-1.	Hibernation Module Register Map .....	119
Table 8-1.	Flash Protection Policy Combinations .....	135
Table 8-2.	Flash Resident Registers .....	136
Table 8-3.	Flash Register Map .....	136
Table 9-1.	GPIO Pad Configuration Examples .....	160
Table 9-2.	GPIO Interrupt Configuration Example .....	160
Table 9-3.	GPIO Register Map .....	162
Table 10-1.	16-Bit Timer With Prescaler Configurations .....	202
Table 10-2.	Timers Register Map .....	208
Table 11-1.	Watchdog Timer Register Map .....	235
Table 12-1.	Samples and FIFO Depth of Sequencers .....	258
Table 12-2.	ADC Register Map .....	262
Table 13-1.	UART Register Map .....	296
Table 14-1.	SSI Register Map .....	342
Table 15-1.	Examples of I <sup>2</sup> C Master Timer Period versus Speed Mode .....	371
Table 15-2.	Inter-Integrated Circuit (I <sup>2</sup> C) Interface Register Map .....	380
Table 15-3.	Write Field Decoding for I2CMCS[3:0] Field (Sheet 1 of 3) .....	385
Table 16-1.	Comparator 0 Operating Modes .....	405
Table 16-2.	Comparator 1 Operating Modes .....	405
Table 16-3.	Comparator 2 Operating Modes .....	406
Table 16-4.	Internal Reference Voltage and ACREFACTL Field Values .....	406
Table 16-5.	Analog Comparators Register Map .....	408
Table 18-1.	Signals by Pin Number .....	417
Table 18-2.	Signals by Signal Name .....	421
Table 18-3.	Signals by Function, Except for GPIO .....	425
Table 18-4.	GPIO Pins and Alternate Functions .....	429
Table 19-1.	Temperature Characteristics .....	431
Table 19-2.	Thermal Characteristics .....	431
Table 20-1.	Maximum Ratings .....	432
Table 20-2.	Recommended DC Operating Conditions .....	432
Table 20-3.	LDO Regulator Characteristics .....	433
Table 20-4.	Flash Memory Characteristics .....	433
Table 20-5.	Phase Locked Loop (PLL) Characteristics .....	434
Table 20-6.	Clock Characteristics .....	434
Table 20-7.	Crystal Characteristics .....	434
Table 20-8.	ADC Characteristics .....	435
Table 20-9.	Analog Comparator Characteristics .....	435
Table 20-10.	Analog Comparator Voltage Reference Characteristics .....	435
Table 20-11.	I <sup>2</sup> C Characteristics .....	436

Table 20-12.	Hibernation Module Characteristics .....	436
Table 20-13.	SSI Characteristics .....	437
Table 20-14.	JTAG Characteristics .....	439
Table 20-15.	GPIO Characteristics .....	441
Table 20-16.	Reset Characteristics .....	441
Table C-1.	Part Ordering Information .....	465

## List of Registers

<b>System Control</b> .....	<b>55</b>
Register 1: Device Identification 0 (DID0), offset 0x000 .....	63
Register 2: Brown-Out Reset Control (PBORCTL), offset 0x030 .....	65
Register 3: LDO Power Control (LDOPCTL), offset 0x034 .....	66
Register 4: Raw Interrupt Status (RIS), offset 0x050 .....	67
Register 5: Interrupt Mask Control (IMC), offset 0x054 .....	68
Register 6: Masked Interrupt Status and Clear (MISC), offset 0x058 .....	69
Register 7: Reset Cause (RESC), offset 0x05C .....	70
Register 8: Run-Mode Clock Configuration (RCC), offset 0x060 .....	71
Register 9: XTAL to PLL Translation (PLLCFG), offset 0x064 .....	75
Register 10: Run-Mode Clock Configuration 2 (RCC2), offset 0x070 .....	76
Register 11: Deep Sleep Clock Configuration (DSLPCCLKCFG), offset 0x144 .....	78
Register 12: Device Identification 1 (DID1), offset 0x004 .....	79
Register 13: Device Capabilities 0 (DC0), offset 0x008 .....	81
Register 14: Device Capabilities 1 (DC1), offset 0x010 .....	82
Register 15: Device Capabilities 2 (DC2), offset 0x014 .....	84
Register 16: Device Capabilities 3 (DC3), offset 0x018 .....	86
Register 17: Device Capabilities 4 (DC4), offset 0x01C .....	88
Register 18: Run Mode Clock Gating Control Register 0 (RCGC0), offset 0x100 .....	89
Register 19: Sleep Mode Clock Gating Control Register 0 (SCGC0), offset 0x110 .....	91
Register 20: Deep Sleep Mode Clock Gating Control Register 0 (DCGC0), offset 0x120 .....	93
Register 21: Run Mode Clock Gating Control Register 1 (RCGC1), offset 0x104 .....	95
Register 22: Sleep Mode Clock Gating Control Register 1 (SCGC1), offset 0x114 .....	98
Register 23: Deep Sleep Mode Clock Gating Control Register 1 (DCGC1), offset 0x124 .....	101
Register 24: Run Mode Clock Gating Control Register 2 (RCGC2), offset 0x108 .....	104
Register 25: Sleep Mode Clock Gating Control Register 2 (SCGC2), offset 0x118 .....	106
Register 26: Deep Sleep Mode Clock Gating Control Register 2 (DCGC2), offset 0x128 .....	108
Register 27: Software Reset Control 0 (SRCR0), offset 0x040 .....	110
Register 28: Software Reset Control 1 (SRCR1), offset 0x044 .....	111
Register 29: Software Reset Control 2 (SRCR2), offset 0x048 .....	113
<b>Hibernation Module</b> .....	<b>114</b>
Register 1: Hibernation RTC Counter (HIBRTCC), offset 0x000 .....	121
Register 2: Hibernation RTC Match 0 (HIBRTCM0), offset 0x004 .....	122
Register 3: Hibernation RTC Match 1 (HIBRTCM1), offset 0x008 .....	123
Register 4: Hibernation RTC Load (HIBRTCLD), offset 0x00C .....	124
Register 5: Hibernation Control (HIBCTL), offset 0x010 .....	125
Register 6: Hibernation Interrupt Mask (HIBIM), offset 0x014 .....	127
Register 7: Hibernation Raw Interrupt Status (HIBRIS), offset 0x018 .....	128
Register 8: Hibernation Masked Interrupt Status (HIBMIS), offset 0x01C .....	129
Register 9: Hibernation Interrupt Clear (HIBIC), offset 0x020 .....	130
Register 10: Hibernation RTC Trim (HIBRTCT), offset 0x024 .....	131
Register 11: Hibernation Data (HIBDATA), offset 0x030-0x12C .....	132
<b>Internal Memory</b> .....	<b>133</b>
Register 1: Flash Memory Address (FMA), offset 0x000 .....	138
Register 2: Flash Memory Data (FMD), offset 0x004 .....	139

Register 3:	Flash Memory Control (FMC), offset 0x008 .....	140
Register 4:	Flash Controller Raw Interrupt Status (FCRIS), offset 0x00C .....	142
Register 5:	Flash Controller Interrupt Mask (FCIM), offset 0x010 .....	143
Register 6:	Flash Controller Masked Interrupt Status and Clear (FCMISC), offset 0x014 .....	144
Register 7:	USec Reload (USECRL), offset 0x140 .....	145
Register 8:	Flash Memory Protection Read Enable 0 (FMPRE0), offset 0x130 and 0x200 .....	146
Register 9:	Flash Memory Protection Program Enable 0 (FMPPE0), offset 0x134 and 0x400 .....	147
Register 10:	User Debug (USER_DBG), offset 0x1D0 .....	148
Register 11:	User Register 0 (USER_REG0), offset 0x1E0 .....	149
Register 12:	User Register 1 (USER_REG1), offset 0x1E4 .....	150
Register 13:	Flash Memory Protection Read Enable 1 (FMPRE1), offset 0x204 .....	151
Register 14:	Flash Memory Protection Read Enable 2 (FMPRE2), offset 0x208 .....	152
Register 15:	Flash Memory Protection Read Enable 3 (FMPRE3), offset 0x20C .....	153
Register 16:	Flash Memory Protection Program Enable 1 (FMPPE1), offset 0x404 .....	154
Register 17:	Flash Memory Protection Program Enable 2 (FMPPE2), offset 0x408 .....	155
Register 18:	Flash Memory Protection Program Enable 3 (FMPPE3), offset 0x40C .....	156
<b>General-Purpose Input/Outputs (GPIOs) .....</b>		<b>157</b>
Register 1:	GPIO Data (GPIODATA), offset 0x000 .....	164
Register 2:	GPIO Direction (GPIODIR), offset 0x400 .....	165
Register 3:	GPIO Interrupt Sense (GPIOIS), offset 0x404 .....	166
Register 4:	GPIO Interrupt Both Edges (GPIOIBE), offset 0x408 .....	167
Register 5:	GPIO Interrupt Event (GPIOIEV), offset 0x40C .....	168
Register 6:	GPIO Interrupt Mask (GPIOIM), offset 0x410 .....	169
Register 7:	GPIO Raw Interrupt Status (GPIORIS), offset 0x414 .....	170
Register 8:	GPIO Masked Interrupt Status (GPIOMIS), offset 0x418 .....	171
Register 9:	GPIO Interrupt Clear (GPIOICR), offset 0x41C .....	172
Register 10:	GPIO Alternate Function Select (GPIOAFSEL), offset 0x420 .....	173
Register 11:	GPIO 2-mA Drive Select (GPIODR2R), offset 0x500 .....	175
Register 12:	GPIO 4-mA Drive Select (GPIODR4R), offset 0x504 .....	176
Register 13:	GPIO 8-mA Drive Select (GPIODR8R), offset 0x508 .....	177
Register 14:	GPIO Open Drain Select (GPIOODR), offset 0x50C .....	178
Register 15:	GPIO Pull-Up Select (GPIOPUR), offset 0x510 .....	179
Register 16:	GPIO Pull-Down Select (GPIOPDR), offset 0x514 .....	180
Register 17:	GPIO Slew Rate Control Select (GPIOSLR), offset 0x518 .....	181
Register 18:	GPIO Digital Enable (GPIODEN), offset 0x51C .....	182
Register 19:	GPIO Lock (GPIOLOCK), offset 0x520 .....	183
Register 20:	GPIO Commit (GPIOCR), offset 0x524 .....	184
Register 21:	GPIO Peripheral Identification 4 (GPIOPeriphID4), offset 0xFD0 .....	186
Register 22:	GPIO Peripheral Identification 5 (GPIOPeriphID5), offset 0xFD4 .....	187
Register 23:	GPIO Peripheral Identification 6 (GPIOPeriphID6), offset 0xFD8 .....	188
Register 24:	GPIO Peripheral Identification 7 (GPIOPeriphID7), offset 0xFDC .....	189
Register 25:	GPIO Peripheral Identification 0 (GPIOPeriphID0), offset 0xFE0 .....	190
Register 26:	GPIO Peripheral Identification 1 (GPIOPeriphID1), offset 0xFE4 .....	191
Register 27:	GPIO Peripheral Identification 2 (GPIOPeriphID2), offset 0xFE8 .....	192
Register 28:	GPIO Peripheral Identification 3 (GPIOPeriphID3), offset 0xFEC .....	193
Register 29:	GPIO PrimeCell Identification 0 (GPIOPCellID0), offset 0xFF0 .....	194
Register 30:	GPIO PrimeCell Identification 1 (GPIOPCellID1), offset 0xFF4 .....	195
Register 31:	GPIO PrimeCell Identification 2 (GPIOPCellID2), offset 0xFF8 .....	196

Register 32: GPIO PrimeCell Identification 3 (GPIOCellID3), offset 0xFFC .....	197
<b>General-Purpose Timers .....</b>	<b>198</b>
Register 1: GPTM Configuration (GPTMCFG), offset 0x000 .....	210
Register 2: GPTM TimerA Mode (GPTMTAMR), offset 0x004 .....	211
Register 3: GPTM TimerB Mode (GPTMTBMR), offset 0x008 .....	213
Register 4: GPTM Control (GPTMCTL), offset 0x00C .....	215
Register 5: GPTM Interrupt Mask (GPTMIMR), offset 0x018 .....	218
Register 6: GPTM Raw Interrupt Status (GPTMRIS), offset 0x01C .....	220
Register 7: GPTM Masked Interrupt Status (GPTMMIS), offset 0x020 .....	221
Register 8: GPTM Interrupt Clear (GPTMICR), offset 0x024 .....	222
Register 9: GPTM TimerA Interval Load (GPTMTAILR), offset 0x028 .....	224
Register 10: GPTM TimerB Interval Load (GPTMTBILR), offset 0x02C .....	225
Register 11: GPTM TimerA Match (GPTMTAMATCHR), offset 0x030 .....	226
Register 12: GPTM TimerB Match (GPTMTBMATCHR), offset 0x034 .....	227
Register 13: GPTM TimerA Prescale (GPTMTAPR), offset 0x038 .....	228
Register 14: GPTM TimerB Prescale (GPTMTBPR), offset 0x03C .....	229
Register 15: GPTM TimerA Prescale Match (GPTMTAPMR), offset 0x040 .....	230
Register 16: GPTM TimerB Prescale Match (GPTMTBPMR), offset 0x044 .....	231
Register 17: GPTM TimerA (GPTMTAR), offset 0x048 .....	232
Register 18: GPTM TimerB (GPTMTBR), offset 0x04C .....	233
<b>Watchdog Timer .....</b>	<b>234</b>
Register 1: Watchdog Load (WDTLOAD), offset 0x000 .....	237
Register 2: Watchdog Value (WDTVALUE), offset 0x004 .....	238
Register 3: Watchdog Control (WDTCTL), offset 0x008 .....	239
Register 4: Watchdog Interrupt Clear (WDTICR), offset 0x00C .....	240
Register 5: Watchdog Raw Interrupt Status (WDTRIS), offset 0x010 .....	241
Register 6: Watchdog Masked Interrupt Status (WDTMIS), offset 0x014 .....	242
Register 7: Watchdog Test (WDTTEST), offset 0x418 .....	243
Register 8: Watchdog Lock (WDTLOCK), offset 0xC00 .....	244
Register 9: Watchdog Peripheral Identification 4 (WDTPeriphID4), offset 0xFD0 .....	245
Register 10: Watchdog Peripheral Identification 5 (WDTPeriphID5), offset 0xFD4 .....	246
Register 11: Watchdog Peripheral Identification 6 (WDTPeriphID6), offset 0xFD8 .....	247
Register 12: Watchdog Peripheral Identification 7 (WDTPeriphID7), offset 0xFDC .....	248
Register 13: Watchdog Peripheral Identification 0 (WDTPeriphID0), offset 0xFE0 .....	249
Register 14: Watchdog Peripheral Identification 1 (WDTPeriphID1), offset 0xFE4 .....	250
Register 15: Watchdog Peripheral Identification 2 (WDTPeriphID2), offset 0xFE8 .....	251
Register 16: Watchdog Peripheral Identification 3 (WDTPeriphID3), offset 0xFEC .....	252
Register 17: Watchdog PrimeCell Identification 0 (WDTPCellID0), offset 0xFF0 .....	253
Register 18: Watchdog PrimeCell Identification 1 (WDTPCellID1), offset 0xFF4 .....	254
Register 19: Watchdog PrimeCell Identification 2 (WDTPCellID2), offset 0xFF8 .....	255
Register 20: Watchdog PrimeCell Identification 3 (WDTPCellID3), offset 0xFFC .....	256
<b>Analog-to-Digital Converter (ADC) .....</b>	<b>257</b>
Register 1: ADC Active Sample Sequencer (ADCACTSS), offset 0x000 .....	264
Register 2: ADC Raw Interrupt Status (ADCRIS), offset 0x004 .....	265
Register 3: ADC Interrupt Mask (ADCIM), offset 0x008 .....	266
Register 4: ADC Interrupt Status and Clear (ADCISC), offset 0x00C .....	267
Register 5: ADC Overflow Status (ADCOSTAT), offset 0x010 .....	268
Register 6: ADC Event Multiplexer Select (ADCEMUX), offset 0x014 .....	269

Register 7:	ADC Underflow Status (ADCUSTAT), offset 0x018 .....	272
Register 8:	ADC Sample Sequencer Priority (ADCSSPRI), offset 0x020 .....	273
Register 9:	ADC Processor Sample Sequence Initiate (ADCPSSI), offset 0x028 .....	274
Register 10:	ADC Sample Averaging Control (ADCSAC), offset 0x030 .....	275
Register 11:	ADC Sample Sequence Input Multiplexer Select 0 (ADCSSMUX0), offset 0x040 .....	276
Register 12:	ADC Sample Sequence Control 0 (ADCSSCTL0), offset 0x044 .....	278
Register 13:	ADC Sample Sequence Result FIFO 0 (ADCSSFIFO0), offset 0x048 .....	281
Register 14:	ADC Sample Sequence Result FIFO 1 (ADCSSFIFO1), offset 0x068 .....	281
Register 15:	ADC Sample Sequence Result FIFO 2 (ADCSSFIFO2), offset 0x088 .....	281
Register 16:	ADC Sample Sequence Result FIFO 3 (ADCSSFIFO3), offset 0x0A8 .....	281
Register 17:	ADC Sample Sequence FIFO 0 Status (ADCSSFSTAT0), offset 0x04C .....	282
Register 18:	ADC Sample Sequence FIFO 1 Status (ADCSSFSTAT1), offset 0x06C .....	282
Register 19:	ADC Sample Sequence FIFO 2 Status (ADCSSFSTAT2), offset 0x08C .....	282
Register 20:	ADC Sample Sequence FIFO 3 Status (ADCSSFSTAT3), offset 0x0AC .....	282
Register 21:	ADC Sample Sequence Input Multiplexer Select 1 (ADCSSMUX1), offset 0x060 .....	283
Register 22:	ADC Sample Sequence Input Multiplexer Select 2 (ADCSSMUX2), offset 0x080 .....	283
Register 23:	ADC Sample Sequence Control 1 (ADCSSCTL1), offset 0x064 .....	284
Register 24:	ADC Sample Sequence Control 2 (ADCSSCTL2), offset 0x084 .....	284
Register 25:	ADC Sample Sequence Input Multiplexer Select 3 (ADCSSMUX3), offset 0x0A0 .....	286
Register 26:	ADC Sample Sequence Control 3 (ADCSSCTL3), offset 0x0A4 .....	287
Register 27:	ADC Test Mode Loopback (ADCTMLB), offset 0x100 .....	288
<b>Universal Asynchronous Receivers/Transmitters (UARTs) .....</b>		<b>290</b>
Register 1:	UART Data (UARTDR), offset 0x000 .....	298
Register 2:	UART Receive Status/Error Clear (UARTRSR/UARTECR), offset 0x004 .....	300
Register 3:	UART Flag (UARTFR), offset 0x018 .....	302
Register 4:	UART IrDA Low-Power Register (UARTILPR), offset 0x020 .....	304
Register 5:	UART Integer Baud-Rate Divisor (UARTIBRD), offset 0x024 .....	305
Register 6:	UART Fractional Baud-Rate Divisor (UARTFBRD), offset 0x028 .....	306
Register 7:	UART Line Control (UARTLCRH), offset 0x02C .....	307
Register 8:	UART Control (UARTCTL), offset 0x030 .....	309
Register 9:	UART Interrupt FIFO Level Select (UARTIFLS), offset 0x034 .....	311
Register 10:	UART Interrupt Mask (UARTIM), offset 0x038 .....	313
Register 11:	UART Raw Interrupt Status (UARTRIS), offset 0x03C .....	315
Register 12:	UART Masked Interrupt Status (UARTMIS), offset 0x040 .....	316
Register 13:	UART Interrupt Clear (UARTICR), offset 0x044 .....	317
Register 14:	UART Peripheral Identification 4 (UARTPeriphID4), offset 0xFD0 .....	319
Register 15:	UART Peripheral Identification 5 (UARTPeriphID5), offset 0xFD4 .....	320
Register 16:	UART Peripheral Identification 6 (UARTPeriphID6), offset 0xFD8 .....	321
Register 17:	UART Peripheral Identification 7 (UARTPeriphID7), offset 0xFDC .....	322
Register 18:	UART Peripheral Identification 0 (UARTPeriphID0), offset 0xFE0 .....	323
Register 19:	UART Peripheral Identification 1 (UARTPeriphID1), offset 0xFE4 .....	324
Register 20:	UART Peripheral Identification 2 (UARTPeriphID2), offset 0xFE8 .....	325
Register 21:	UART Peripheral Identification 3 (UARTPeriphID3), offset 0xFEC .....	326
Register 22:	UART PrimeCell Identification 0 (UARTPCellID0), offset 0xFF0 .....	327
Register 23:	UART PrimeCell Identification 1 (UARTPCellID1), offset 0xFF4 .....	328
Register 24:	UART PrimeCell Identification 2 (UARTPCellID2), offset 0xFF8 .....	329
Register 25:	UART PrimeCell Identification 3 (UARTPCellID3), offset 0xFFC .....	330

<b>Synchronous Serial Interface (SSI)</b> .....	<b>331</b>
Register 1: SSI Control 0 (SSICR0), offset 0x000 .....	343
Register 2: SSI Control 1 (SSICR1), offset 0x004 .....	345
Register 3: SSI Data (SSIDR), offset 0x008 .....	347
Register 4: SSI Status (SSISR), offset 0x00C .....	348
Register 5: SSI Clock Prescale (SSICPSR), offset 0x010 .....	350
Register 6: SSI Interrupt Mask (SSIIM), offset 0x014 .....	351
Register 7: SSI Raw Interrupt Status (SSIRIS), offset 0x018 .....	353
Register 8: SSI Masked Interrupt Status (SSIMIS), offset 0x01C .....	354
Register 9: SSI Interrupt Clear (SSIICR), offset 0x020 .....	355
Register 10: SSI Peripheral Identification 4 (SSIPeriphID4), offset 0xFD0 .....	356
Register 11: SSI Peripheral Identification 5 (SSIPeriphID5), offset 0xFD4 .....	357
Register 12: SSI Peripheral Identification 6 (SSIPeriphID6), offset 0xFD8 .....	358
Register 13: SSI Peripheral Identification 7 (SSIPeriphID7), offset 0xFDC .....	359
Register 14: SSI Peripheral Identification 0 (SSIPeriphID0), offset 0xFE0 .....	360
Register 15: SSI Peripheral Identification 1 (SSIPeriphID1), offset 0xFE4 .....	361
Register 16: SSI Peripheral Identification 2 (SSIPeriphID2), offset 0xFE8 .....	362
Register 17: SSI Peripheral Identification 3 (SSIPeriphID3), offset 0xFEC .....	363
Register 18: SSI PrimeCell Identification 0 (SSIPCellID0), offset 0xFF0 .....	364
Register 19: SSI PrimeCell Identification 1 (SSIPCellID1), offset 0xFF4 .....	365
Register 20: SSI PrimeCell Identification 2 (SSIPCellID2), offset 0xFF8 .....	366
Register 21: SSI PrimeCell Identification 3 (SSIPCellID3), offset 0xFFC .....	367
<b>Inter-Integrated Circuit (I<sup>2</sup>C) Interface</b> .....	<b>368</b>
Register 1: I <sup>2</sup> C Master Slave Address (I2CMSA), offset 0x000 .....	382
Register 2: I <sup>2</sup> C Master Control/Status (I2CMCS), offset 0x004 .....	383
Register 3: I <sup>2</sup> C Master Data (I2CMDR), offset 0x008 .....	387
Register 4: I <sup>2</sup> C Master Timer Period (I2CMTPR), offset 0x00C .....	388
Register 5: I <sup>2</sup> C Master Interrupt Mask (I2CMIMR), offset 0x010 .....	389
Register 6: I <sup>2</sup> C Master Raw Interrupt Status (I2CMRIS), offset 0x014 .....	390
Register 7: I <sup>2</sup> C Master Masked Interrupt Status (I2CMMIS), offset 0x018 .....	391
Register 8: I <sup>2</sup> C Master Interrupt Clear (I2CMICR), offset 0x01C .....	392
Register 9: I <sup>2</sup> C Master Configuration (I2CMCR), offset 0x020 .....	393
Register 10: I <sup>2</sup> C Slave Own Address (I2CSOAR), offset 0x000 .....	395
Register 11: I <sup>2</sup> C Slave Control/Status (I2CSCSR), offset 0x004 .....	396
Register 12: I <sup>2</sup> C Slave Data (I2CSDR), offset 0x008 .....	398
Register 13: I <sup>2</sup> C Slave Interrupt Mask (I2CSIMR), offset 0x00C .....	399
Register 14: I <sup>2</sup> C Slave Raw Interrupt Status (I2CSRIS), offset 0x010 .....	400
Register 15: I <sup>2</sup> C Slave Masked Interrupt Status (I2CSMIS), offset 0x014 .....	401
Register 16: I <sup>2</sup> C Slave Interrupt Clear (I2CSICR), offset 0x018 .....	402
<b>Analog Comparators</b> .....	<b>403</b>
Register 1: Analog Comparator Masked Interrupt Status (ACMIS), offset 0x00 .....	409
Register 2: Analog Comparator Raw Interrupt Status (ACRIS), offset 0x04 .....	410
Register 3: Analog Comparator Interrupt Enable (ACINTEN), offset 0x08 .....	411
Register 4: Analog Comparator Reference Voltage Control (ACREFCTL), offset 0x10 .....	412
Register 5: Analog Comparator Status 0 (ACSTAT0), offset 0x20 .....	413
Register 6: Analog Comparator Status 1 (ACSTAT1), offset 0x40 .....	413
Register 7: Analog Comparator Status 2 (ACSTAT2), offset 0x60 .....	413



Register 8:	Analog Comparator Control 0 (ACCTL0), offset 0x24 .....	414
Register 9:	Analog Comparator Control 1 (ACCTL1), offset 0x44 .....	414
Register 10:	Analog Comparator Control 2 (ACCTL2), offset 0x64 .....	414

## About This Document

This data sheet provides reference information for the LM3S1138 microcontroller, describing the functional blocks of the system-on-chip (SoC) device designed around the ARM® Cortex™-M3 core.

### Audience

This manual is intended for system software developers, hardware designers, and application developers.

### About This Manual

This document is organized into sections that correspond to each major feature.

### Related Documents

The following documents are referenced by the data sheet, and available on the documentation CD or from the Luminary Micro web site at [www.luminarymicro.com](http://www.luminarymicro.com):

- *ARM® Cortex™-M3 Technical Reference Manual*
- *ARM® CoreSight Technical Reference Manual*
- *ARM® v7-M Architecture Application Level Reference Manual*

The following related documents are also referenced:

- *IEEE Standard 1149.1-Test Access Port and Boundary-Scan Architecture*

This documentation list was current as of publication date. Please check the Luminary Micro web site for additional documentation, including application notes and white papers.

### Documentation Conventions

This document uses the conventions shown in Table 1 on page 18.

**Table 1. Documentation Conventions**

Notation	Meaning
<b>General Register Notation</b>	
<b>REGISTER</b>	APB registers are indicated in uppercase bold. For example, <b>PBORCTL</b> is the Power-On and Brown-Out Reset Control register. If a register name contains a lowercase n, it represents more than one register. For example, <b>SRCRn</b> represents any (or all) of the three Software Reset Control registers: <b>SRCR0</b> , <b>SRCR1</b> , and <b>SRCR2</b> .
bit	A single bit in a register.
bit field	Two or more consecutive and related bits.
offset 0xnnn	A hexadecimal increment to a register's address, relative to that module's base address as specified in "Memory Map" on page 39.
Register N	Registers are numbered consecutively throughout the document to aid in referencing them. The register number has no meaning to software.

Notation	Meaning
reserved	Register bits marked <i>reserved</i> are reserved for future use. In most cases, reserved bits are set to 0; however, user software should not rely on the value of a reserved bit. To provide software compatibility with future products, the value of a reserved bit should be preserved across a read-modify-write operation.
yy:xx	The range of register bits inclusive from xx to yy. For example, 31:15 means bits 15 through 31 in that register.
<b>Register Bit/Field Types</b>	This value in the register bit diagram indicates whether software running on the controller can change the value of the bit field.
RC	Software can read this field. The bit or field is cleared by hardware after reading the bit/field.
RO	Software can read this field. Always write the chip reset value.
R/W	Software can read or write this field.
R/W1C	Software can read or write this field. A write of a 0 to a W1C bit does not affect the bit value in the register. A write of a 1 clears the value of the bit in the register; the remaining bits remain unchanged.  This register type is primarily used for clearing interrupt status bits where the read operation provides the interrupt status and the write of the read value clears only the interrupts being reported at the time the register was read.
W1C	Software can write this field. A write of a 0 to a W1C bit does not affect the bit value in the register. A write of a 1 clears the value of the bit in the register; the remaining bits remain unchanged. A read of the register returns no meaningful data.  This register is typically used to clear the corresponding bit in an interrupt register.
WO	Only a write by software is valid; a read of the register returns no meaningful data.
<b>Register Bit/Field Reset Value</b>	This value in the register bit diagram shows the bit/field value after any reset, unless noted.
0	Bit cleared to 0 on chip reset.
1	Bit set to 1 on chip reset.
-	Nondeterministic.
<b>Pin/Signal Notation</b>	
[ ]	Pin alternate function; a pin defaults to the signal without the brackets.
pin	Refers to the physical connection on the package.
signal	Refers to the electrical signal encoding of a pin.
assert a signal	Change the value of the signal from the logically False state to the logically True state. For active High signals, the asserted signal value is 1 (High); for active Low signals, the asserted signal value is 0 (Low). The active polarity (High or Low) is defined by the signal name (see <code>SIGNAL</code> and <code>SIGNAL</code> below).
deassert a signal	Change the value of the signal from the logically True state to the logically False state.
<code>SIGNAL</code>	Signal names are in uppercase and in the Courier font. An overbar on a signal name indicates that it is active Low. To assert <code>SIGNAL</code> is to drive it Low; to deassert <code>SIGNAL</code> is to drive it High.
<code>SIGNAL</code>	Signal names are in uppercase and in the Courier font. An active High signal has no overbar. To assert <code>SIGNAL</code> is to drive it High; to deassert <code>SIGNAL</code> is to drive it Low.
<b>Numbers</b>	
X	An uppercase X indicates any of several values is allowed, where X can be any legal pattern. For example, a binary value of 0X00 can be either 0100 or 0000, a hex value of 0xX is 0x0 or 0x1, and so on.
0x	Hexadecimal numbers have a prefix of 0x. For example, 0x00FF is the hexadecimal number FF.  All other numbers within register tables are assumed to be binary. Within conceptual information, binary numbers are indicated with a b suffix, for example, 1011b, and decimal numbers are written without a prefix or suffix.

# 1 Architectural Overview

The Luminary Micro Stellaris<sup>®</sup> family of microcontrollers—the first ARM<sup>®</sup> Cortex<sup>™</sup>-M3 based controllers—brings high-performance 32-bit computing to cost-sensitive embedded microcontroller applications. These pioneering parts deliver customers 32-bit performance at a cost equivalent to legacy 8- and 16-bit devices, all in a package with a small footprint.

The Stellaris<sup>®</sup> family offers efficient performance and extensive integration, favorably positioning the device into cost-conscious applications requiring significant control-processing and connectivity capabilities. The Stellaris<sup>®</sup> LM3S2000 series, designed for Controller Area Network (CAN) applications, extends the Stellaris family with Bosch CAN networking technology, the golden standard in short-haul industrial networks. The Stellaris<sup>®</sup> LM3S2000 series also marks the first integration of CAN capabilities with the revolutionary Cortex-M3 core. The Stellaris<sup>®</sup> LM3S6000 series combines both a 10/100 Ethernet Media Access Control (MAC) and Physical (PHY) layer, marking the first time that integrated connectivity is available with an ARM Cortex-M3 MCU and the only integrated 10/100 Ethernet MAC and PHY available in an ARM architecture MCU.

The LM3S1138 microcontroller is targeted for industrial applications, including remote monitoring, electronic point-of-sale machines, test and measurement equipment, network appliances and switches, factory automation, HVAC and building control, gaming equipment, motion control, medical instrumentation, and fire and security.

For applications requiring extreme conservation of power, the LM3S1138 microcontroller features a Battery-backed Hibernation module to efficiently power down the LM3S1138 to a low-power state during extended periods of inactivity. With a power-up/power-down sequencer, a continuous time counter (RTC), a pair of match registers, an APB interface to the system bus, and dedicated non-volatile memory, the Hibernation module positions the LM3S1138 microcontroller perfectly for battery applications.

In addition, the LM3S1138 microcontroller offers the advantages of ARM's widely available development tools, System-on-Chip (SoC) infrastructure IP applications, and a large user community. Additionally, the microcontroller uses ARM's Thumb<sup>®</sup>-compatible Thumb-2 instruction set to reduce memory requirements and, thereby, cost. Finally, the LM3S1138 microcontroller is code-compatible to all members of the extensive Stellaris<sup>®</sup> family; providing flexibility to fit our customers' precise needs.

Luminary Micro offers a complete solution to get to market quickly, with evaluation and development boards, white papers and application notes, an easy-to-use peripheral driver library, and a strong support, sales, and distributor network.

## 1.1 Product Features

The LM3S1138 microcontroller includes the following product features:

- 32-Bit RISC Performance
  - 32-bit ARM<sup>®</sup> Cortex<sup>™</sup>-M3 v7M architecture optimized for small-footprint embedded applications
  - System timer (SysTick), providing a simple, 24-bit clear-on-write, decrementing, wrap-on-zero counter with a flexible control mechanism
  - Thumb<sup>®</sup>-compatible Thumb-2-only instruction set processor core for high code density
  - 50-MHz operation

- Hardware-division and single-cycle-multiplication
- Integrated Nested Vectored Interrupt Controller (NVIC) providing deterministic interrupt handling
- 34 interrupts with eight priority levels
- Memory protection unit (MPU), providing a privileged mode for protected operating system functionality
- Unaligned data access, enabling data to be efficiently packed into memory
- Atomic bit manipulation (bit-banding), delivering maximum memory utilization and streamlined peripheral control
- Internal Memory
  - 64 KB single-cycle flash
    - User-managed flash block protection on a 2-KB block basis
    - User-managed flash data programming
    - User-defined and managed flash-protection block
  - 16 KB single-cycle SRAM
- General-Purpose Timers
  - Four General-Purpose Timer Modules (GPTM), each of which provides two 16-bit timer/counters. Each GPTM can be configured to operate independently as timers or event counters: as a single 32-bit timer, as one 32-bit Real-Time Clock (RTC) to event capture, for Pulse Width Modulation (PWM), or to trigger analog-to-digital conversions
  - 32-bit Timer modes
    - Programmable one-shot timer
    - Programmable periodic timer
    - Real-Time Clock when using an external 32.768-KHz clock as the input
    - User-enabled stalling in periodic and one-shot mode when the controller asserts the CPU Halt flag during debug
    - ADC event trigger
  - 16-bit Timer modes
    - General-purpose timer function with an 8-bit prescaler
    - Programmable one-shot timer
    - Programmable periodic timer
    - User-enabled stalling when the controller asserts CPU Halt flag during debug

- ADC event trigger
- 16-bit Input Capture modes
  - Input edge count capture
  - Input edge time capture
- 16-bit PWM mode
  - Simple PWM mode with software-programmable output inversion of the PWM signal
- ARM FiRM-compliant Watchdog Timer
  - 32-bit down counter with a programmable load register
  - Separate watchdog clock with an enable
  - Programmable interrupt generation logic with interrupt masking
  - Lock register protection from runaway software
  - Reset generation logic with an enable/disable
  - User-enabled stalling when the controller asserts the CPU Halt flag during debug
- Synchronous Serial Interface (SSI)
  - Two SSI modules, each with the following features:
    - Master or slave operation
    - Programmable clock bit rate and prescale
    - Separate transmit and receive FIFOs, 16 bits wide, 8 locations deep
    - Programmable interface operation for Freescale SPI, MICROWIRE, or Texas Instruments synchronous serial interfaces
    - Programmable data frame size from 4 to 16 bits
    - Internal loopback test mode for diagnostic/debug testing
- UART
  - Three fully programmable 16C550-type UARTs with IrDA support
  - Separate 16x8 transmit (TX) and 16x12 receive (RX) FIFOs to reduce CPU interrupt service loading
  - Programmable baud-rate generator with fractional divider
  - Programmable FIFO length, including 1-byte deep operation providing conventional double-buffered interface
  - FIFO trigger levels of 1/8, 1/4, 1/2, 3/4, and 7/8

- Standard asynchronous communication bits for start, stop, and parity
- False-start-bit detection
- Line-break generation and detection
- ADC
  - Single- and differential-input configurations
  - Eight 10-bit channels (inputs) when used as single-ended inputs
  - Sample rate of one million samples/second
  - Flexible, configurable analog-to-digital conversion
  - Four programmable sample conversion sequences from one to eight entries long, with corresponding conversion result FIFOs
  - Each sequence triggered by software or internal event (timers, analog comparators, or GPIO)
  - On-chip temperature sensor
- Analog Comparators
  - Three independent integrated analog comparators
  - Configurable for output to: drive an output pin, generate an interrupt, or initiate an ADC sample sequence
  - Compare external pin input to external pin input or to internal programmable voltage reference
- I<sup>2</sup>C
  - Two I<sup>2</sup>C modules
  - Master and slave receive and transmit operation with transmission speed up to 100 Kbps in Standard mode and 400 Kbps in Fast mode
  - Interrupt generation
  - Master with arbitration and clock synchronization, multimaster support, and 7-bit addressing mode
- GPIOs
  - 9-46 GPIOs, depending on configuration
  - 5-V-tolerant input/outputs
  - Programmable interrupt generation as either edge-triggered or level-sensitive
  - Bit masking in both read and write operations through address lines
  - Can initiate an ADC sample sequence

- Programmable control for GPIO pad configuration:
  - Weak pull-up or pull-down resistors
  - 2-mA, 4-mA, and 8-mA pad drive
  - Slew rate control for the 8-mA drive
  - Open drain enables
  - Digital input enables
- Power
  - On-chip Low Drop-Out (LDO) voltage regulator, with programmable output user-adjustable from 2.25 V to 2.75 V
  - Hibernation module handles the power-up/down 3.3 V sequencing and control for the core digital logic and analog circuits
  - Low-power options on controller: Sleep and Deep-sleep modes
  - Low-power options for peripherals: software controls shutdown of individual peripherals
  - User-enabled LDO unregulated voltage detection and automatic reset
  - 3.3-V supply brown-out detection and reporting via interrupt or reset
- Flexible Reset Sources
  - Power-on reset (POR)
  - Reset pin assertion
  - Brown-out (BOR) detector alerts to system power drops
  - Software reset
  - Watchdog timer reset
  - Internal low drop-out (LDO) regulator output goes unregulated
- Additional Features
  - Six reset sources
  - Programmable clock source control
  - Clock gating to individual peripherals for power savings
  - IEEE 1149.1-1990 compliant Test Access Port (TAP) controller
  - Debug access via JTAG and Serial Wire interfaces
  - Full JTAG boundary scan
- Industrial-range 100-pin RoHS-compliant LQFP package



## 1.2 Target Applications

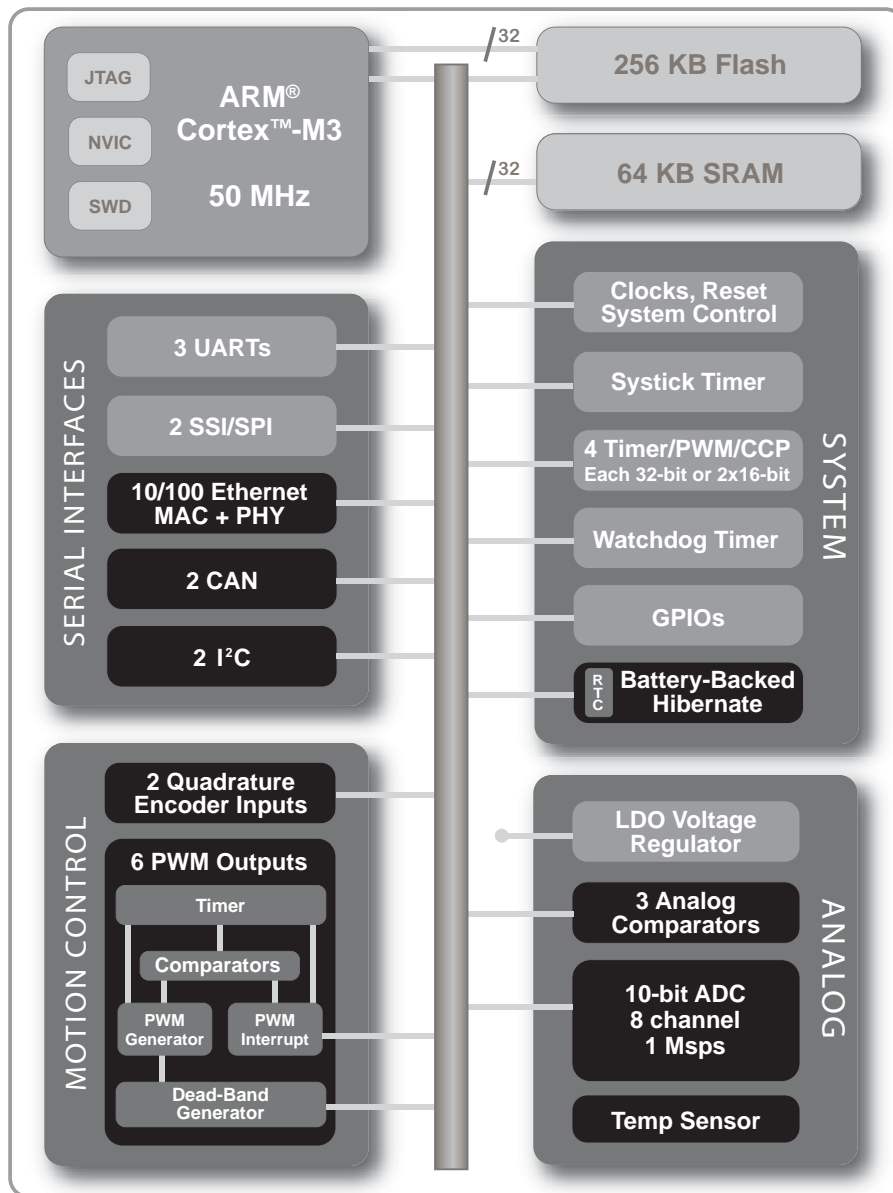
- Remote monitoring
- Electronic point-of-sale (POS) machines
- Test and measurement equipment
- Network appliances and switches
- Factory automation
- HVAC and building control
- Gaming equipment
- Motion control
- Medical instrumentation
- Fire and security
- Power and energy
- Transportation

## 1.3 High-Level Block Diagram

Figure 1-1 on page 26 shows the features on the Stellaris® Fury-class family of devices.

**Note:** Figure 1-1 on page 26 indicates the full set of features available on all the devices in the Stellaris® Fury-class family, not all the features on this specific device.

Figure 1-1. Stellaris® Fury-class Family High-Level Block Diagram



## 1.4 Functional Overview

The following sections provide an overview of the features of the LM3S1138 microcontroller. The page number in parenthesis indicates where that feature is discussed in detail. Ordering and support information can be found in “Ordering and Contact Information” on page 465.

## 1.4.1 ARM Cortex™-M3

### 1.4.1.1 Processor Core (see page 33)

All members of the Stellaris® product family, including the LM3S1138 microcontroller, are designed around an ARM Cortex™-M3 processor core. The ARM Cortex-M3 processor provides the core for a high-performance, low-cost platform that meets the needs of minimal memory implementation, reduced pin count, and low-power consumption, while delivering outstanding computational performance and exceptional system response to interrupts.

“ARM Cortex-M3 Processor Core” on page 33 provides an overview of the ARM core; the core is detailed in the *ARM® Cortex™-M3 Technical Reference Manual*.

### 1.4.1.2 System Timer (SysTick)

Cortex-M3 includes an integrated system timer, SysTick. SysTick provides a simple, 24-bit clear-on-write, decrementing, wrap-on-zero counter with a flexible control mechanism. The counter can be used in several different ways, for example:

- An RTOS tick timer which fires at a programmable rate (for example, 100 Hz) and invokes a SysTick routine.
- A high-speed alarm timer using the system clock.
- A variable rate alarm or signal timer—the duration is range-dependent on the reference clock used and the dynamic range of the counter.
- A simple counter. Software can use this to measure time to completion and time used.
- An internal clock source control based on missing/meeting durations. The COUNTFLAG bit-field in the control and status register can be used to determine if an action completed within a set duration, as part of a dynamic clock management control loop.

### 1.4.1.3 Nested Vectored Interrupt Controller (NVIC)

The LM3S1138 controller includes the ARM Nested Vectored Interrupt Controller (NVIC) on the ARM Cortex-M3 core. The NVIC and Cortex-M3 prioritize and handle all exceptions. All exceptions are handled in Handler Mode. The processor state is automatically stored to the stack on an exception, and automatically restored from the stack at the end of the Interrupt Service Routine (ISR). The vector is fetched in parallel to the state saving, which enables efficient interrupt entry. The processor supports tail-chaining, which enables back-to-back interrupts to be performed without the overhead of state saving and restoration. Software can set eight priority levels on 7 exceptions (system handlers) and 34 interrupts.

“Interrupts” on page 41 provides an overview of the NVIC controller and the interrupt map. Exceptions and interrupts are detailed in the *ARM® Cortex™-M3 Technical Reference Manual*.

## 1.4.2 Motor Control Peripherals

To enhance motor control, the LM3S1138 controller features Pulse Width Modulation (PWM) outputs.

### 1.4.2.1 PWM (see page 204)

Pulse width modulation (PWM) is a powerful technique for digitally encoding analog signal levels. High-resolution counters are used to generate a square wave, and the duty cycle of the square wave is modulated to encode an analog signal. Typical applications include switching power supplies and motor control.

On the LM3S1138, PWM motion control functionality can be achieved through the motion control features of the general-purpose timers (using the CCP pins).

**CCP Pins (see page 204)**

The General-Purpose Timer Module's CCP (Capture Compare PWM) pins are software programmable to support a simple PWM mode with a software-programmable output inversion of the PWM signal.

### 1.4.3 Analog Peripherals

To handle analog signals, the LM3S1138 microcontroller offers an Analog-to-Digital Converter (ADC).

For support of analog signals, the LM3S1138 microcontroller offers three analog comparators.

#### 1.4.3.1 ADC (see page 257)

An analog-to-digital converter (ADC) is a peripheral that converts a continuous analog voltage to a discrete digital number.

The LM3S1138 ADC module features 10-bit conversion resolution and supports eight input channels, plus an internal temperature sensor. Four buffered sample sequences allow rapid sampling of up to eight analog input sources without controller intervention. Each sample sequence provides flexible programming with fully configurable input source, trigger events, interrupt generation, and sequence priority.

#### 1.4.3.2 Analog Comparators (see page 403)

An analog comparator is a peripheral that compares two analog voltages, and provides a logical output that signals the comparison result.

The LM3S1138 microcontroller provides three independent integrated analog comparators that can be configured to drive an output or generate an interrupt or ADC event.

A comparator can compare a test voltage against any one of these voltages:

- An individual external reference voltage
- A shared single external reference voltage
- A shared internal reference voltage

The comparator can provide its output to a device pin, acting as a replacement for an analog comparator on the board, or it can be used to signal the application via interrupts or triggers to the ADC to cause it to start capturing a sample sequence. The interrupt generation and ADC triggering logic is separate. This means, for example, that an interrupt can be generated on a rising edge and the ADC triggered on a falling edge.

### 1.4.4 Serial Communications Peripherals

The LM3S1138 controller supports both asynchronous and synchronous serial communications with:

- Three fully programmable 16C550-type UARTs
- Two SSI modules
- Two I<sup>2</sup>C modules

#### 1.4.4.1 UART (see page 290)

A Universal Asynchronous Receiver/Transmitter (UART) is an integrated circuit used for RS-232C serial communications, containing a transmitter (parallel-to-serial converter) and a receiver (serial-to-parallel converter), each clocked separately.

The LM3S1138 controller includes three fully programmable 16C550-type UARTs that support data transfer speeds up to 460.8 Kbps. (Although similar in functionality to a 16C550 UART, it is not register-compatible.) In addition, each UART is capable of supporting IrDA.

Separate 16x8 transmit (TX) and 16x12 receive (RX) FIFOs reduce CPU interrupt service loading. The UART can generate individually masked interrupts from the RX, TX, modem status, and error conditions. The module provides a single combined interrupt when any of the interrupts are asserted and are unmasked.

#### 1.4.4.2 SSI (see page 331)

Synchronous Serial Interface (SSI) is a four-wire bi-directional communications interface.

The LM3S1138 controller includes two SSI modules that provide the functionality for synchronous serial communications with peripheral devices, and can be configured to use the Freescale SPI, MICROWIRE, or TI synchronous serial interface frame formats. The size of the data frame is also configurable, and can be set between 4 and 16 bits, inclusive.

Each SSI module performs serial-to-parallel conversion on data received from a peripheral device, and parallel-to-serial conversion on data transmitted to a peripheral device. The TX and RX paths are buffered with internal FIFOs, allowing up to eight 16-bit values to be stored independently.

Each SSI module can be configured as either a master or slave device. As a slave device, the SSI module can also be configured to disable its output, which allows a master device to be coupled with multiple slave devices.

Each SSI module also includes a programmable bit rate clock divider and prescaler to generate the output serial clock derived from the SSI module's input clock. Bit rates are generated based on the input clock and the maximum bit rate is determined by the connected peripheral.

#### 1.4.4.3 I<sup>2</sup>C (see page 368)

The Inter-Integrated Circuit (I<sup>2</sup>C) bus provides bi-directional data transfer through a two-wire design (a serial data line SDA and a serial clock line SCL).

The I<sup>2</sup>C bus interfaces to external I<sup>2</sup>C devices such as serial memory (RAMs and ROMs), networking devices, LCDs, tone generators, and so on. The I<sup>2</sup>C bus may also be used for system testing and diagnostic purposes in product development and manufacture.

The LM3S1138 controller includes two I<sup>2</sup>C modules that provide the ability to communicate to other IC devices over an I<sup>2</sup>C bus. The I<sup>2</sup>C bus supports devices that can both transmit and receive (write and read) data.

Devices on the I<sup>2</sup>C bus can be designated as either a master or a slave. Each I<sup>2</sup>C module supports both sending and receiving data as either a master or a slave, and also supports the simultaneous operation as both a master and a slave. The four I<sup>2</sup>C modes are: Master Transmit, Master Receive, Slave Transmit, and Slave Receive.

A Stellaris<sup>®</sup> I<sup>2</sup>C module can operate at two speeds: Standard (100 Kbps) and Fast (400 Kbps).

Both the I<sup>2</sup>C master and slave can generate interrupts. The I<sup>2</sup>C master generates interrupts when a transmit or receive operation completes (or aborts due to an error). The I<sup>2</sup>C slave generates interrupts when data has been sent or requested by a master.

## 1.4.5 System Peripherals

### 1.4.5.1 Programmable GPIOs (see page 157)

General-purpose input/output (GPIO) pins offer flexibility for a variety of connections.

The Stellaris<sup>®</sup> GPIO module is composed of eight physical GPIO blocks, each corresponding to an individual GPIO port. The GPIO module is FiRM-compliant (compliant to the ARM Foundation IP for Real-Time Microcontrollers specification) and supports 9-46 programmable input/output pins. The number of GPIOs available depends on the peripherals being used (see “Signal Tables” on page 417 for the signals available to each GPIO pin).

The GPIO module features programmable interrupt generation as either edge-triggered or level-sensitive on all pins, programmable control for GPIO pad configuration, and bit masking in both read and write operations through address lines.

### 1.4.5.2 Four Programmable Timers (see page 198)

Programmable timers can be used to count or time external events that drive the Timer input pins.

The Stellaris<sup>®</sup> General-Purpose Timer Module (GPTM) contains four GPTM blocks. Each GPTM block provides two 16-bit timer/counters that can be configured to operate independently as timers or event counters, or configured to operate as one 32-bit timer or one 32-bit Real-Time Clock (RTC). Timers can also be used to trigger analog-to-digital (ADC) conversions.

When configured in 32-bit mode, a timer can run as a one-shot timer, periodic timer, or Real-Time Clock (RTC). When in 16-bit mode, a timer can run as a one-shot timer or periodic timer, and can extend its precision by using an 8-bit prescaler. A 16-bit timer can also be configured for event capture or Pulse Width Modulation (PWM) generation.

### 1.4.5.3 Watchdog Timer (see page 234)

A watchdog timer can generate nonmaskable interrupts (NMIs) or a reset when a time-out value is reached. The watchdog timer is used to regain control when a system has failed due to a software error or to the failure of an external device to respond in the expected way.

The Stellaris<sup>®</sup> Watchdog Timer module consists of a 32-bit down counter, a programmable load register, interrupt generation logic, and a locking register.

The Watchdog Timer can be configured to generate an interrupt to the controller on its first time-out, and to generate a reset signal on its second time-out. Once the Watchdog Timer has been configured, the lock register can be written to prevent the timer configuration from being inadvertently altered.

## 1.4.6 Memory Peripherals

The LM3S1138 controller offers both single-cycle SRAM and single-cycle Flash memory.

### 1.4.6.1 SRAM (see page 133)

The LM3S1138 static random access memory (SRAM) controller supports 16 KB SRAM. The internal SRAM of the Stellaris<sup>®</sup> devices is located at offset 0x0000.0000 of the device memory map. To reduce the number of time-consuming read-modify-write (RMW) operations, ARM has introduced *bit-banding* technology in the new Cortex-M3 processor. With a bit-band-enabled processor, certain regions in the memory map (SRAM and peripheral space) can use address aliases to access individual bits in a single, atomic operation.

### 1.4.6.2 Flash (see page 134)

The LM3S1138 Flash controller supports 64 KB of flash memory. The flash is organized as a set of 1-KB blocks that can be individually erased. Erasing a block causes the entire contents of the block to be reset to all 1s. These blocks are paired into a set of 2-KB blocks that can be individually protected. The blocks can be marked as read-only or execute-only, providing different levels of code protection. Read-only blocks cannot be erased or programmed, protecting the contents of those blocks from being modified. Execute-only blocks cannot be erased or programmed, and can only be read by the controller instruction fetch mechanism, protecting the contents of those blocks from being read by either the controller or by a debugger.

## 1.4.7 Additional Features

### 1.4.7.1 Memory Map (see page 39)

A memory map lists the location of instructions and data in memory. The memory map for the LM3S1138 controller can be found in “Memory Map” on page 39. Register addresses are given as a hexadecimal increment, relative to the module’s base address as shown in the memory map.

The *ARM® Cortex™-M3 Technical Reference Manual* provides further information on the memory map.

### 1.4.7.2 JTAG TAP Controller (see page 44)

The Joint Test Action Group (JTAG) port provides a standardized serial interface for controlling the Test Access Port (TAP) and associated test logic. The TAP, JTAG instruction register, and JTAG data registers can be used to test the interconnects of assembled printed circuit boards, obtain manufacturing information on the components, and observe and/or control the inputs and outputs of the controller during normal operation. The JTAG port provides a high degree of testability and chip-level access at a low cost.

The JTAG port is comprised of the standard five pins:  $\overline{\text{TRST}}$ , TCK, TMS, TDI, and TDO. Data is transmitted serially into the controller on TDI and out of the controller on TDO. The interpretation of this data is dependent on the current state of the TAP controller. For detailed information on the operation of the JTAG port and TAP controller, please refer to the *IEEE Standard 1149.1-Test Access Port and Boundary-Scan Architecture*.

The Luminary Micro JTAG controller works with the ARM JTAG controller built into the Cortex-M3 core. This is implemented by multiplexing the TDO outputs from both JTAG controllers. ARM JTAG instructions select the ARM TDO output while Luminary Micro JTAG instructions select the Luminary Micro TDO outputs. The multiplexer is controlled by the Luminary Micro JTAG controller, which has comprehensive programming for the ARM, Luminary Micro, and unimplemented JTAG instructions.

### 1.4.7.3 System Control and Clocks (see page 55)

System control determines the overall operation of the device. It provides information about the device, controls the clocking of the device and individual peripherals, and handles reset detection and reporting.

### 1.4.7.4 Hibernation Module (see page 114)

The Hibernation module provides logic to switch power off to the main processor and peripherals, and to wake on external or time-based events. The Hibernation module includes power-sequencing logic, a real-time clock with a pair of match registers, low-battery detection circuitry, and interrupt signalling to the processor. It also includes 64 32-bit words of non-volatile memory that can be used for saving state during hibernation.

### **1.4.8 Hardware Details**

Details on the pins and package can be found in the following sections:

- “Pin Diagram” on page 416
- “Signal Tables” on page 417
- “Operating Characteristics” on page 431
- “Electrical Characteristics” on page 432
- “Package Information” on page 443



## 2 ARM Cortex-M3 Processor Core

The ARM Cortex-M3 processor provides the core for a high-performance, low-cost platform that meets the needs of minimal memory implementation, reduced pin count, and low power consumption, while delivering outstanding computational performance and exceptional system response to interrupts. Features include:

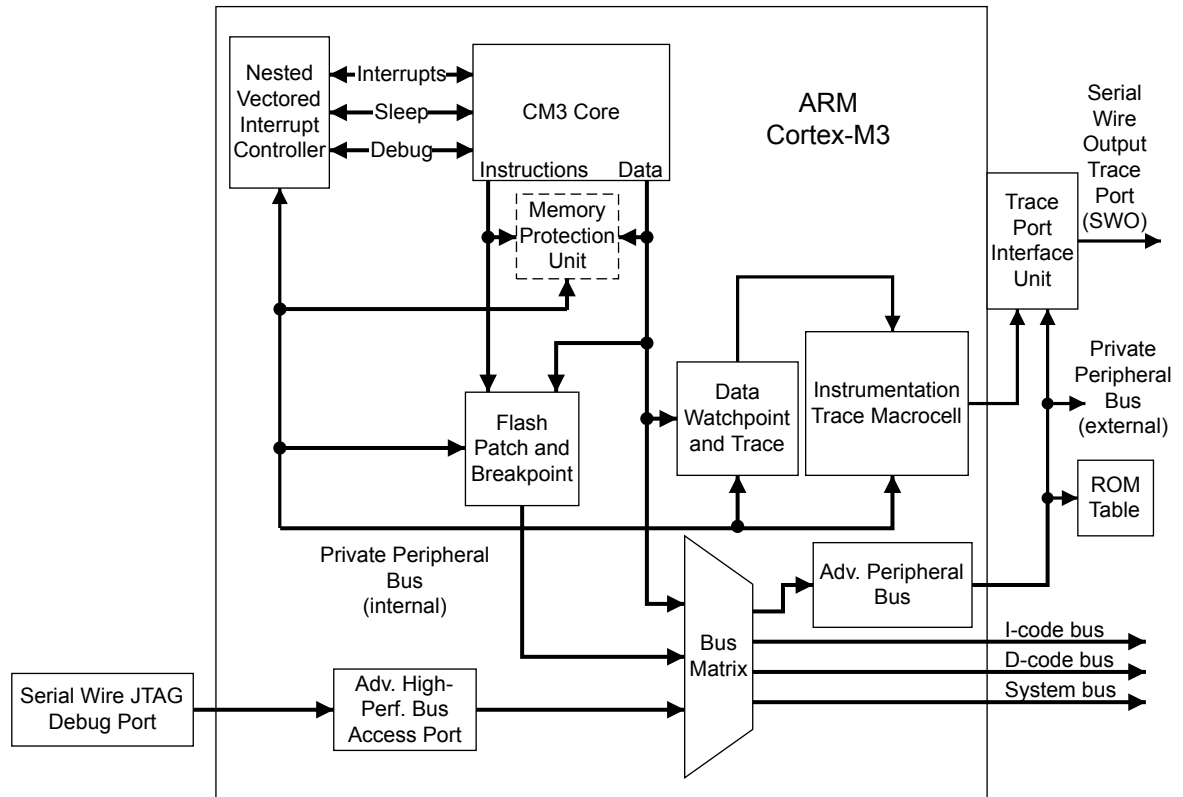
- Compact core.
- Thumb-2 instruction set, delivering the high-performance expected of an ARM core in the memory size usually associated with 8- and 16-bit devices; typically in the range of a few kilobytes of memory for microcontroller class applications.
- Rapid application execution through Harvard architecture characterized by separate buses for instruction and data.
- Exceptional interrupt handling, by implementing the register manipulations required for handling an interrupt in hardware.
- Memory protection unit (MPU) to provide a privileged mode of operation for complex applications.
- Migration from the ARM7™ processor family for better performance and power efficiency.
- Full-featured debug solution with a:
  - Serial Wire JTAG Debug Port (SWJ-DP)
  - Flash Patch and Breakpoint (FPB) unit for implementing breakpoints
  - Data Watchpoint and Trigger (DWT) unit for implementing watchpoints, trigger resources, and system profiling
  - Instrumentation Trace Macrocell (ITM) for support of printf style debugging
  - Trace Port Interface Unit (TPIU) for bridging to a Trace Port Analyzer

The Stellaris® family of microcontrollers builds on this core to bring high-performance 32-bit computing to cost-sensitive embedded microcontroller applications, such as factory automation and control, industrial control power devices, building and home automation, and stepper motors.

For more information on the ARM Cortex-M3 processor core, see the *ARM® Cortex™-M3 Technical Reference Manual*. For information on SWJ-DP, see the *ARM® CoreSight Technical Reference Manual*.

## 2.1 Block Diagram

Figure 2-1. CPU Block Diagram



## 2.2 Functional Description

**Important:** The *ARM® Cortex™-M3 Technical Reference Manual* describes all the features of an ARM Cortex-M3 in detail. However, these features differ based on the implementation. This section describes the Stellaris® implementation.

Luminary Micro has implemented the ARM Cortex-M3 core as shown in Figure 2-1 on page 34. As noted in the *ARM® Cortex™-M3 Technical Reference Manual*, several Cortex-M3 components are flexible in their implementation: SW/JTAG-DP, ETM, TPIU, the ROM table, the MPU, and the Nested Vectored Interrupt Controller (NVIC). Each of these is addressed in the sections that follow.

### 2.2.1 Serial Wire and JTAG Debug

Luminary Micro has replaced the ARM SW-DP and JTAG-DP with the ARM CoreSight™-compliant Serial Wire JTAG Debug Port (SWJ-DP) interface. This means Chapter 12, “Debug Port,” of the *ARM® Cortex™-M3 Technical Reference Manual* does not apply to Stellaris® devices.

The SWJ-DP interface combines the SWD and JTAG debug ports into one module. See the *CoreSight™ Design Kit Technical Reference Manual* for details on SWJ-DP.

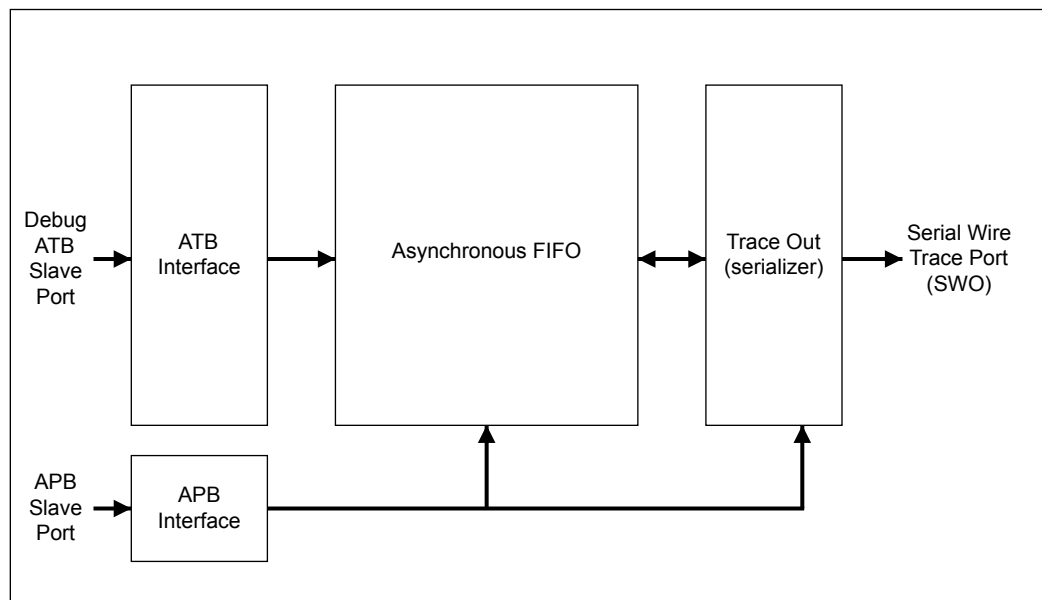
## 2.2.2 Embedded Trace Macrocell (ETM)

ETM was not implemented in the Stellaris<sup>®</sup> devices. This means Chapters 15 and 16 of the *ARM<sup>®</sup> Cortex<sup>™</sup>-M3 Technical Reference Manual* can be ignored.

## 2.2.3 Trace Port Interface Unit (TPIU)

The TPIU acts as a bridge between the Cortex-M3 trace data from the ITM, and an off-chip Trace Port Analyzer. The Stellaris<sup>®</sup> devices have implemented TPIU as shown in Figure 2-2 on page 35. This is similar to the non-ETM version described in the *ARM<sup>®</sup> Cortex<sup>™</sup>-M3 Technical Reference Manual*, however, SWJ-DP only provides SWV output for the TPIU.

**Figure 2-2. TPIU Block Diagram**



## 2.2.4 ROM Table

The default ROM table was implemented as described in the *ARM<sup>®</sup> Cortex<sup>™</sup>-M3 Technical Reference Manual*.

## 2.2.5 Memory Protection Unit (MPU)

The Memory Protection Unit (MPU) is included on the LM3S1138 controller and supports the standard ARMv7 Protected Memory System Architecture (PMSA) model. The MPU provides full support for protection regions, overlapping protection regions, access permissions, and exporting memory attributes to the system.

## 2.2.6 Nested Vectored Interrupt Controller (NVIC)

The Nested Vectored Interrupt Controller (NVIC):

- Facilitates low-latency exception and interrupt handling
- Controls power management
- Implements system control registers

The NVIC supports up to 240 dynamically reprioritizable interrupts each with up to 256 levels of priority. The NVIC and the processor core interface are closely coupled, which enables low latency interrupt processing and efficient processing of late arriving interrupts. The NVIC maintains knowledge of the stacked (nested) interrupts to enable tail-chaining of interrupts.

You can only fully access the NVIC from privileged mode, but you can pend interrupts in user-mode if you enable the Configuration Control Register (see the ARM® Cortex™-M3 Technical Reference Manual). Any other user-mode access causes a bus fault.

All NVIC registers are accessible using byte, halfword, and word unless otherwise stated.

All NVIC registers and system debug registers are little endian regardless of the endianness state of the processor.

### 2.2.6.1 Interrupts

The *ARM® Cortex™-M3 Technical Reference Manual* describes the maximum number of interrupts and interrupt priorities. The LM3S1138 microcontroller supports 34 interrupts with eight priority levels.

### 2.2.6.2 System Timer (SysTick)

Cortex-M3 includes an integrated system timer, SysTick. SysTick provides a simple, 24-bit clear-on-write, decrementing, wrap-on-zero counter with a flexible control mechanism. The counter can be used in several different ways, for example:

- An RTOS tick timer which fires at a programmable rate (for example, 100 Hz) and invokes a SysTick routine.
- A high-speed alarm timer using the system clock.
- A variable rate alarm or signal timer—the duration is range-dependent on the reference clock used and the dynamic range of the counter.
- A simple counter. Software can use this to measure time to completion and time used.
- An internal clock source control based on missing/meeting durations. The COUNTFLAG bit-field in the control and status register can be used to determine if an action completed within a set duration, as part of a dynamic clock management control loop.

#### **Functional Description**

The timer consists of three registers:

- A control and status counter to configure its clock, enable the counter, enable the SysTick interrupt, and determine counter status.
- The reload value for the counter, used to provide the counter's wrap value.
- The current value of the counter.

A fourth register, the SysTick Calibration Value Register, is not implemented in the Stellaris® devices.

When enabled, the timer counts down from the reload value to zero, reloads (wraps) to the value in the SysTick Reload Value register on the next clock edge, then decrements on subsequent clocks. Writing a value of zero to the Reload Value register disables the counter on the next wrap. When the counter reaches zero, the COUNTFLAG status bit is set. The COUNTFLAG bit clears on reads.

Writing to the Current Value register clears the register and the COUNTFLAG status bit. The write does not trigger the SysTick exception logic. On a read, the current value is the value of the register at the time the register is accessed.

If the core is in debug state (halted), the counter will not decrement. The timer is clocked with respect to a reference clock. The reference clock can be the core clock or an external clock source.

### **SysTick Control and Status Register**

Use the SysTick Control and Status Register to enable the SysTick features. The reset is 0x0000.0000.

Bit/Field	Name	Type	Reset	Description
31:17	reserved	RO	0	Software should not rely on the value of a reserved bit. To provide compatibility with future products, the value of a reserved bit should be preserved across a read-modify-write operation.
16	COUNTFLAG	R/W	0	Returns 1 if timer counted to 0 since last time this was read. Clears on read by application. If read by the debugger using the DAP, this bit is cleared on read-only if the MasterType bit in the AHB-AP Control Register is set to 0. Otherwise, the COUNTFLAG bit is not changed by the debugger read.
15:3	reserved	RO	0	Software should not rely on the value of a reserved bit. To provide compatibility with future products, the value of a reserved bit should be preserved across a read-modify-write operation.
2	CLKSOURCE	R/W	0	0 = external reference clock. (Not implemented for Stellaris microcontrollers.) 1 = core clock.  If no reference clock is provided, it is held at 1 and so gives the same time as the core clock. The core clock must be at least 2.5 times faster than the reference clock. If it is not, the count values are unpredictable.
1	TICKINT	R/W	0	1 = counting down to 0 pends the SysTick handler.  0 = counting down to 0 does not pend the SysTick handler. Software can use the COUNTFLAG to determine if ever counted to 0.
0	ENABLE	R/W	0	1 = counter operates in a multi-shot way. That is, counter loads with the Reload value and then begins counting down. On reaching 0, it sets the COUNTFLAG to 1 and optionally pends the SysTick handler, based on TICKINT. It then loads the Reload value again, and begins counting.  0 = counter disabled.

### **SysTick Reload Value Register**

Use the SysTick Reload Value Register to specify the start value to load into the current value register when the counter reaches 0. It can be any value between 1 and 0x00FF.FFFF. A start value of 0 is possible, but has no effect because the SysTick interrupt and COUNTFLAG are activated when counting from 1 to 0.

Therefore, as a multi-shot timer, repeated over and over, it fires every N+1 clock pulse, where N is any value from 1 to 0x00FF.FFFF. So, if the tick interrupt is required every 100 clock pulses, 99 must be written into the RELOAD. If a new value is written on each tick interrupt, so treated as single shot, then the actual count down must be written. For example, if a tick is next required after 400 clock pulses, 400 must be written into the RELOAD.

Bit/Field	Name	Type	Reset	Description
31:24	reserved	RO	0	Software should not rely on the value of a reserved bit. To provide compatibility with future products, the value of a reserved bit should be preserved across a read-modify-write operation.

Bit/Field	Name	Type	Reset	Description
23:0	RELOAD	W1C	-	Value to load into the SysTick Current Value Register when the counter reaches 0.

### ***SysTick Current Value Register***

Use the SysTick Current Value Register to find the current value in the register.

Bit/Field	Name	Type	Reset	Description
31:24	reserved	RO	0	Software should not rely on the value of a reserved bit. To provide compatibility with future products, the value of a reserved bit should be preserved across a read-modify-write operation.
23:0	CURRENT	W1C	-	Current value at the time the register is accessed. No read-modify-write protection is provided, so change with care.  This register is write-clear. Writing to it with any value clears the register to 0. Clearing this register also clears the COUNTFLAG bit of the SysTick Control and Status Register.

### ***SysTick Calibration Value Register***

The SysTick Calibration Value register is not implemented.

### 3 Memory Map

The memory map for the LM3S1138 controller is provided in Table 3-1 on page 39.

In this manual, register addresses are given as a hexadecimal increment, relative to the module's base address as shown in the memory map. See also Chapter 4, "Memory Map" in the *ARM® Cortex™-M3 Technical Reference Manual*.

**Important:** In Table 3-1 on page 39, addresses not listed are reserved.

**Table 3-1. Memory Map<sup>a</sup>**

Start	End	Description	For details on registers, see page ...
<b>Memory</b>			
0x0000.0000	0x0000.FFFF	On-chip flash <sup>b</sup>	137
0x2000.0000	0x2000.3FFF	Bit-banded on-chip SRAM <sup>c</sup>	137
0x2010.0000	0x21FF.FFFF	Reserved non-bit-banded SRAM space	-
0x2200.0000	0x23FF.FFFF	Bit-band alias of 0x2000.0000 through 0x200F.FFFF	133
0x2400.0000	0x3FFF.FFFF	Reserved non-bit-banded SRAM space	-
<b>FiRM Peripherals</b>			
0x4000.0000	0x4000.0FFF	Watchdog timer	236
0x4000.4000	0x4000.4FFF	GPIO Port A	163
0x4000.5000	0x4000.5FFF	GPIO Port B	163
0x4000.6000	0x4000.6FFF	GPIO Port C	163
0x4000.7000	0x4000.7FFF	GPIO Port D	163
0x4000.8000	0x4000.8FFF	SSI0	342
0x4000.9000	0x4000.9FFF	SSI1	342
0x4000.C000	0x4000.CFFF	UART0	297
0x4000.D000	0x4000.DFFF	UART1	297
0x4000.E000	0x4000.EFFF	UART2	297
<b>Peripherals</b>			
0x4002.0000	0x4002.07FF	I2C Master 0	381
0x4002.0800	0x4002.0FFF	I2C Slave 0	394
0x4002.1000	0x4002.17FF	I2C Master 1	381
0x4002.1800	0x4002.1FFF	I2C Slave 1	394
0x4002.4000	0x4002.4FFF	GPIO Port E	163
0x4002.5000	0x4002.5FFF	GPIO Port F	163
0x4002.6000	0x4002.6FFF	GPIO Port G	163
0x4002.7000	0x4002.7FFF	GPIO Port H	163
0x4003.0000	0x4003.0FFF	Timer0	209
0x4003.1000	0x4003.1FFF	Timer1	209
0x4003.2000	0x4003.2FFF	Timer2	209
0x4003.3000	0x4003.3FFF	Timer3	209
0x4003.8000	0x4003.8FFF	ADC	263

Start	End	Description	For details on registers, see page ...
0x4003.C000	0x4003.CFFF	Analog Comparators	403
0x400F.C000	0x400F.CFFF	Hibernation Module	120
0x400F.D000	0x400F.DFFF	Flash control	137
0x400F.E000	0x400F.EFFF	System control	62
0x4200.0000	0x43FF.FFFF	Bit-banded alias of 0x4000.0000 through 0x400F.FFFF	-
<b>Private Peripheral Bus</b>			
0xE000.0000	0xE000.0FFF	Instrumentation Trace Macrocell (ITM)	ARM® Cortex™-M3 Technical Reference Manual
0xE000.1000	0xE000.1FFF	Data Watchpoint and Trace (DWT)	
0xE000.2000	0xE000.2FFF	Flash Patch and Breakpoint (FPB)	
0xE000.3000	0xE000.DFFF	Reserved	
0xE000.E000	0xE000.EFFF	Nested Vectored Interrupt Controller (NVIC)	
0xE000.F000	0xE003.FFFF	Reserved	
0xE004.0000	0xE004.0FFF	Trace Port Interface Unit (TPIU)	
0xE004.1000	0xE004.1FFF	Reserved	
0xE004.2000	0xE00F.FFFF	Reserved	-
0xE010.0000	0xFFFF.FFFF	Reserved for vendor peripherals	-

- a. All reserved space returns a bus fault when read or written.
- b. The unavailable flash will bus fault throughout this range.
- c. The unavailable SRAM will bus fault throughout this range.



## 4 Interrupts

The ARM Cortex-M3 processor and the Nested Vectored Interrupt Controller (NVIC) prioritize and handle all exceptions. All exceptions are handled in Handler Mode. The processor state is automatically stored to the stack on an exception, and automatically restored from the stack at the end of the Interrupt Service Routine (ISR). The vector is fetched in parallel to the state saving, which enables efficient interrupt entry. The processor supports tail-chaining, which enables back-to-back interrupts to be performed without the overhead of state saving and restoration.

Table 4-1 on page 41 lists all the exceptions. Software can set eight priority levels on seven of these exceptions (system handlers) as well as on 34 interrupts (listed in Table 4-2 on page 42).

Priorities on the system handlers are set with the NVIC System Handler Priority registers. Interrupts are enabled through the NVIC Interrupt Set Enable register and prioritized with the NVIC Interrupt Priority registers. You can also group priorities by splitting priority levels into pre-emption priorities and subpriorities. All the interrupt registers are described in Chapter 8, “Nested Vectored Interrupt Controller” in the *ARM® Cortex™-M3 Technical Reference Manual*.

Internally, the highest user-settable priority (0) is treated as fourth priority, after a Reset, NMI, and a Hard Fault. Note that 0 is the default priority for all the settable priorities.

If you assign the same priority level to two or more interrupts, their hardware priority (the lower the position number) determines the order in which the processor activates them. For example, if both GPIO Port A and GPIO Port B are priority level 1, then GPIO Port A has higher priority.

See Chapter 5, “Exceptions” and Chapter 8, “Nested Vectored Interrupt Controller” in the *ARM® Cortex™-M3 Technical Reference Manual* for more information on exceptions and interrupts.

**Note:** In Table 4-2 on page 42 interrupts not listed are reserved.

**Table 4-1. Exception Types**

Exception Type	Position	Priority <sup>a</sup>	Description
-	0	-	Stack top is loaded from first entry of vector table on reset.
Reset	1	-3 (highest)	Invoked on power up and warm reset. On first instruction, drops to lowest priority (and then is called the base level of activation). This is asynchronous.
Non-Maskable Interrupt (NMI)	2	-2	Cannot be stopped or preempted by any exception but reset. This is asynchronous.  An NMI is only producible by software, using the NVIC <b>Interrupt Control State</b> register.
Hard Fault	3	-1	All classes of Fault, when the fault cannot activate due to priority or the configurable fault handler has been disabled. This is synchronous.
Memory Management	4	settable	MPU mismatch, including access violation and no match. This is synchronous.  The priority of this exception can be changed.
Bus Fault	5	settable	Pre-fetch fault, memory access fault, and other address/memory related faults. This is synchronous when precise and asynchronous when imprecise.  You can enable or disable this fault.
Usage Fault	6	settable	Usage fault, such as undefined instruction executed or illegal state transition attempt. This is synchronous.
-	7-10	-	Reserved.
SVCcall	11	settable	System service call with SVC instruction. This is synchronous.

Exception Type	Position	Priority <sup>a</sup>	Description
Debug Monitor	12	settable	Debug monitor (when not halting). This is synchronous, but only active when enabled. It does not activate if lower priority than the current activation.
-	13	-	Reserved.
PendSV	14	settable	Pendable request for system service. This is asynchronous and only pended by software.
SysTick	15	settable	System tick timer has fired. This is asynchronous.
Interrupts	16 and above	settable	Asserted from outside the ARM Cortex-M3 core and fed through the NVIC (prioritized). These are all asynchronous. Table 4-2 on page 42 lists the interrupts on the LM3S1138 controller.

a. 0 is the default priority for all the settable priorities.

**Table 4-2. Interrupts**

Interrupt (Bit in Interrupt Registers)	Description
0	GPIO Port A
1	GPIO Port B
2	GPIO Port C
3	GPIO Port D
4	GPIO Port E
5	UART0
6	UART1
7	SSI0
8	I2C0
14	ADC Sequence 0
15	ADC Sequence 1
16	ADC Sequence 2
17	ADC Sequence 3
18	Watchdog timer
19	Timer0 A
20	Timer0 B
21	Timer1 A
22	Timer1 B
23	Timer2 A
24	Timer2 B
25	Analog Comparator 0
26	Analog Comparator 1
27	Analog Comparator 2
28	System Control
29	Flash Control
30	GPIO Port F
31	GPIO Port G
32	GPIO Port H
33	UART2
34	SSI1

---

Interrupt (Bit in Interrupt Registers)	Description
35	Timer3 A
36	Timer3 B
37	I2C1
43	Hibernation Module
44-47	Reserved

## 5 JTAG Interface

The Joint Test Action Group (JTAG) port is an IEEE standard that defines a Test Access Port and Boundary Scan Architecture for digital integrated circuits and provides a standardized serial interface for controlling the associated test logic. The TAP, Instruction Register (IR), and Data Registers (DR) can be used to test the interconnections of assembled printed circuit boards and obtain manufacturing information on the components. The JTAG Port also provides a means of accessing and controlling design-for-test features such as I/O pin observation and control, scan testing, and debugging.

The JTAG port is comprised of the standard five pins:  $\overline{\text{TRST}}$ , TCK, TMS, TDI, and TDO. Data is transmitted serially into the controller on TDI and out of the controller on TDO. The interpretation of this data is dependent on the current state of the TAP controller. For detailed information on the operation of the JTAG port and TAP controller, please refer to the *IEEE Standard 1149.1-Test Access Port and Boundary-Scan Architecture*.

The Luminary Micro JTAG controller works with the ARM JTAG controller built into the Cortex-M3 core. This is implemented by multiplexing the TDO outputs from both JTAG controllers. ARM JTAG instructions select the ARM TDO output while Luminary Micro JTAG instructions select the Luminary Micro TDO outputs. The multiplexer is controlled by the Luminary Micro JTAG controller, which has comprehensive programming for the ARM, LMI, and unimplemented JTAG instructions.

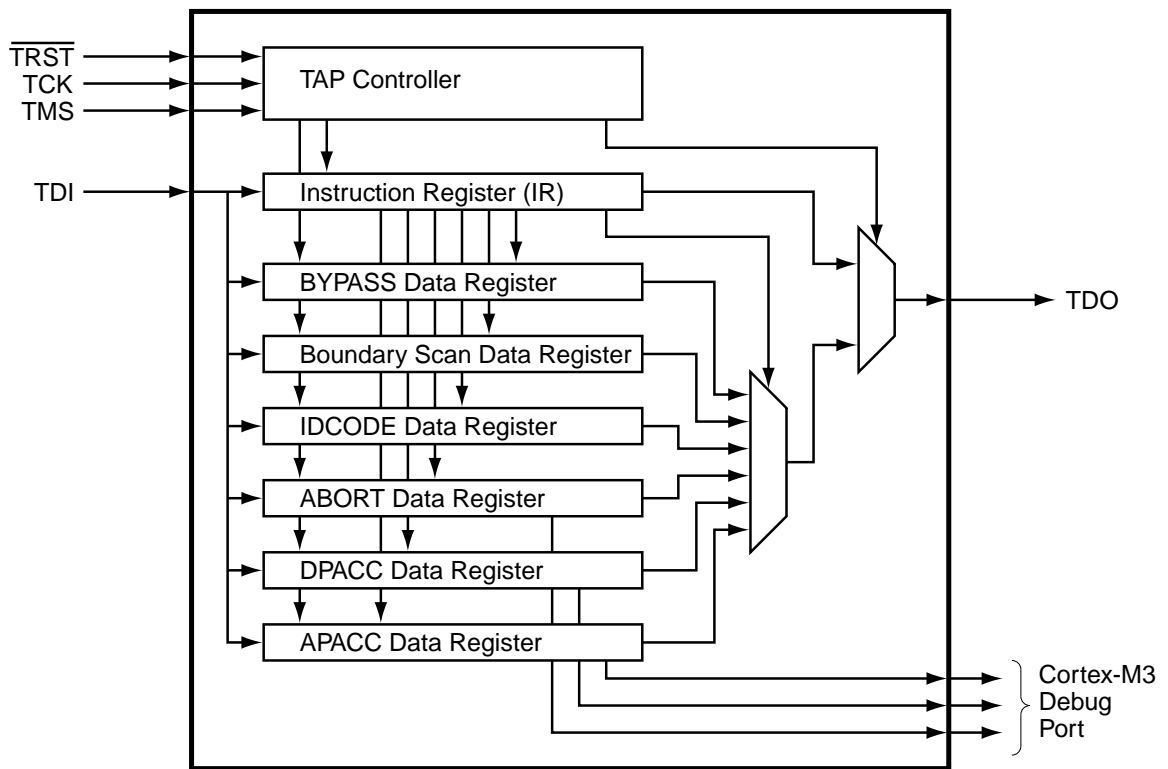
The JTAG module has the following features:

- IEEE 1149.1-1990 compatible Test Access Port (TAP) controller
- Four-bit Instruction Register (IR) chain for storing JTAG instructions
- IEEE standard instructions:
  - BYPASS instruction
  - IDCODE instruction
  - SAMPLE/PRELOAD instruction
  - EXTEST instruction
  - INTEST instruction
- ARM additional instructions:
  - APACC instruction
  - DPACC instruction
  - ABORT instruction
- Integrated ARM Serial Wire Debug (SWD)

See the *ARM® Cortex™-M3 Technical Reference Manual* for more information on the ARM JTAG controller.

## 5.1 Block Diagram

Figure 5-1. JTAG Module Block Diagram



## 5.2 Functional Description

A high-level conceptual drawing of the JTAG module is shown in Figure 5-1 on page 45. The JTAG module is composed of the Test Access Port (TAP) controller and serial shift chains with parallel update registers. The TAP controller is a simple state machine controlled by the  $\overline{\text{TRST}}$ ,  $\text{TCK}$  and  $\text{TMS}$  inputs. The current state of the TAP controller depends on the current value of  $\overline{\text{TRST}}$  and the sequence of values captured on  $\text{TMS}$  at the rising edge of  $\text{TCK}$ . The TAP controller determines when the serial shift chains capture new data, shift data from  $\text{TDI}$  towards  $\text{TDO}$ , and update the parallel load registers. The current state of the TAP controller also determines whether the Instruction Register (IR) chain or one of the Data Register (DR) chains is being accessed.

The serial shift chains with parallel load registers are comprised of a single Instruction Register (IR) chain and multiple Data Register (DR) chains. The current instruction loaded in the parallel load register determines which DR chain is captured, shifted, or updated during the sequencing of the TAP controller.

Some instructions, like  $\text{EXTEST}$  and  $\text{INTEST}$ , operate on data currently in a DR chain and do not capture, shift, or update any of the chains. Instructions that are not implemented decode to the  $\text{BYPASS}$  instruction to ensure that the serial path between  $\text{TDI}$  and  $\text{TDO}$  is always connected (see Table 5-2 on page 51 for a list of implemented instructions).

See “JTAG and Boundary Scan” on page 439 for JTAG timing diagrams.

## 5.2.1 JTAG Interface Pins

The JTAG interface consists of five standard pins:  $\overline{\text{TRST}}$ , TCK, TMS, TDI, and TDO. These pins and their associated reset state are given in Table 5-1 on page 46. Detailed information on each pin follows.

**Table 5-1. JTAG Port Pins Reset State**

Pin Name	Data Direction	Internal Pull-Up	Internal Pull-Down	Drive Strength	Drive Value
$\overline{\text{TRST}}$	Input	Enabled	Disabled	N/A	N/A
TCK	Input	Enabled	Disabled	N/A	N/A
TMS	Input	Enabled	Disabled	N/A	N/A
TDI	Input	Enabled	Disabled	N/A	N/A
TDO	Output	Enabled	Disabled	2-mA driver	High-Z

### 5.2.1.1 Test Reset Input ( $\overline{\text{TRST}}$ )

The  $\overline{\text{TRST}}$  pin is an asynchronous active Low input signal for initializing and resetting the JTAG TAP controller and associated JTAG circuitry. When  $\overline{\text{TRST}}$  is asserted, the TAP controller resets to the Test-Logic-Reset state and remains there while  $\overline{\text{TRST}}$  is asserted. When the TAP controller enters the Test-Logic-Reset state, the JTAG Instruction Register (IR) resets to the default instruction, IDCODE.

By default, the internal pull-up resistor on the  $\overline{\text{TRST}}$  pin is enabled after reset. Changes to the pull-up resistor settings on GPIO Port B should ensure that the internal pull-up resistor remains enabled on PB7/ $\overline{\text{TRST}}$ ; otherwise JTAG communication could be lost.

### 5.2.1.2 Test Clock Input (TCK)

The TCK pin is the clock for the JTAG module. This clock is provided so the test logic can operate independently of any other system clocks. In addition, it ensures that multiple JTAG TAP controllers that are daisy-chained together can synchronously communicate serial test data between components. During normal operation, TCK is driven by a free-running clock with a nominal 50% duty cycle. When necessary, TCK can be stopped at 0 or 1 for extended periods of time. While TCK is stopped at 0 or 1, the state of the TAP controller does not change and data in the JTAG Instruction and Data Registers is not lost.

By default, the internal pull-up resistor on the TCK pin is enabled after reset. This assures that no clocking occurs if the pin is not driven from an external source. The internal pull-up and pull-down resistors can be turned off to save internal power as long as the TCK pin is constantly being driven by an external source.

### 5.2.1.3 Test Mode Select (TMS)

The TMS pin selects the next state of the JTAG TAP controller. TMS is sampled on the rising edge of TCK. Depending on the current TAP state and the sampled value of TMS, the next state is entered. Because the TMS pin is sampled on the rising edge of TCK, the *IEEE Standard 1149.1* expects the value on TMS to change on the falling edge of TCK.

Holding TMS high for five consecutive TCK cycles drives the TAP controller state machine to the Test-Logic-Reset state. When the TAP controller enters the Test-Logic-Reset state, the JTAG Instruction Register (IR) resets to the default instruction, IDCODE. Therefore, this sequence can be used as a reset mechanism, similar to asserting  $\overline{\text{TRST}}$ . The JTAG Test Access Port state machine can be seen in its entirety in Figure 5-2 on page 48.

By default, the internal pull-up resistor on the TMS pin is enabled after reset. Changes to the pull-up resistor settings on GPIO Port C should ensure that the internal pull-up resistor remains enabled on PC1/TMS; otherwise JTAG communication could be lost.

#### 5.2.1.4 Test Data Input (TDI)

The TDI pin provides a stream of serial information to the IR chain and the DR chains. TDI is sampled on the rising edge of TCK and, depending on the current TAP state and the current instruction, presents this data to the proper shift register chain. Because the TDI pin is sampled on the rising edge of TCK, the *IEEE Standard 1149.1* expects the value on TDI to change on the falling edge of TCK.

By default, the internal pull-up resistor on the TDI pin is enabled after reset. Changes to the pull-up resistor settings on GPIO Port C should ensure that the internal pull-up resistor remains enabled on PC2/TDI; otherwise JTAG communication could be lost.

#### 5.2.1.5 Test Data Output (TDO)

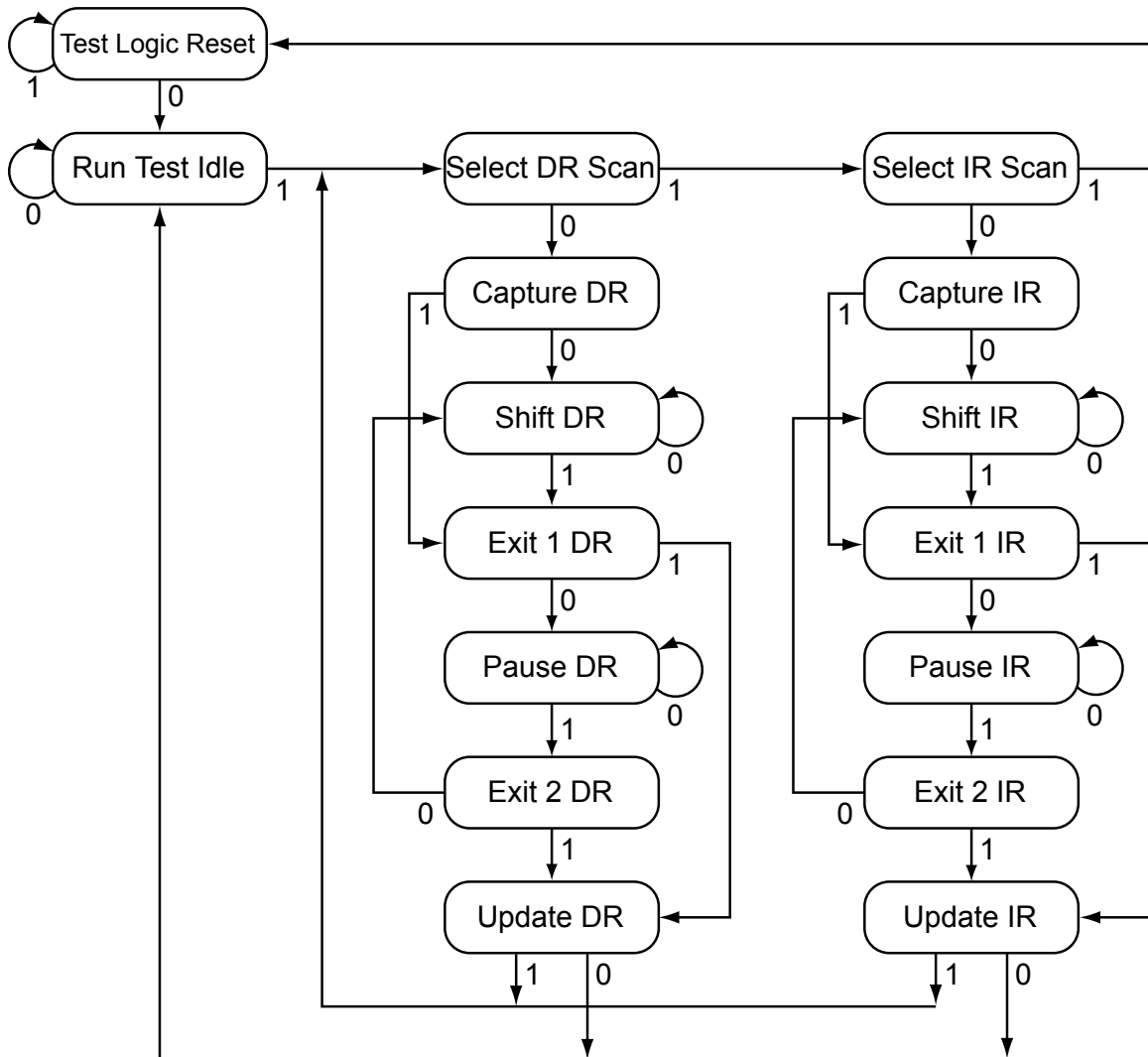
The TDO pin provides an output stream of serial information from the IR chain or the DR chains. The value of TDO depends on the current TAP state, the current instruction, and the data in the chain being accessed. In order to save power when the JTAG port is not being used, the TDO pin is placed in an inactive drive state when not actively shifting out data. Because TDO can be connected to the TDI of another controller in a daisy-chain configuration, the *IEEE Standard 1149.1* expects the value on TDO to change on the falling edge of TCK.

By default, the internal pull-up resistor on the TDO pin is enabled after reset. This assures that the pin remains at a constant logic level when the JTAG port is not being used. The internal pull-up and pull-down resistors can be turned off to save internal power if a High-Z output value is acceptable during certain TAP controller states.

### 5.2.2 JTAG TAP Controller

The JTAG TAP controller state machine is shown in Figure 5-2 on page 48. The TAP controller state machine is reset to the Test-Logic-Reset state on the assertion of a Power-On-Reset (POR) or the assertion of  $\overline{\text{TRST}}$ . Asserting the correct sequence on the TMS pin allows the JTAG module to shift in new instructions, shift in data, or idle during extended testing sequences. For detailed information on the function of the TAP controller and the operations that occur in each state, please refer to *IEEE Standard 1149.1*.

Figure 5-2. Test Access Port State Machine



### 5.2.3 Shift Registers

The Shift Registers consist of a serial shift register chain and a parallel load register. The serial shift register chain samples specific information during the TAP controller's CAPTURE states and allows this information to be shifted out of TDO during the TAP controller's SHIFT states. While the sampled data is being shifted out of the chain on TDO, new data is being shifted into the serial shift register on TDI. This new data is stored in the parallel load register during the TAP controller's UPDATE states. Each of the shift registers is discussed in detail in "Register Descriptions" on page 51.

### 5.2.4 Operational Considerations

There are certain operational considerations when using the JTAG module. Because the JTAG pins can be programmed to be GPIOs, board configuration and reset conditions on these pins must be considered. In addition, because the JTAG module has integrated ARM Serial Wire Debug, the method for switching between these two operational modes is described below.



### 5.2.4.1 GPIO Functionality

When the controller is reset with either a POR or  $\overline{\text{RST}}$ , the JTAG/SWD port pins default to their JTAG/SWD configurations. The default configuration includes enabling digital functionality (setting **GPIO DEN** to 1), enabling the pull-up resistors (setting **GPIO PUR** to 1), and enabling the alternate hardware function (setting **GPIO AFSEL** to 1) for the  $\text{PB7}$  and  $\text{PC}[3:0]$  JTAG/SWD pins.

It is possible for software to configure these pins as GPIOs after reset by writing 0s to  $\text{PB7}$  and  $\text{PC}[3:0]$  in the **GPIO AFSEL** register. If the user does not require the JTAG/SWD port for debugging or board-level testing, this provides five more GPIOs for use in the design.

**Caution** – If the JTAG pins are used as GPIOs in a design,  $\text{PB7}$  and  $\text{PC2}$  cannot have external pull-down resistors connected to both of them at the same time. If both pins are pulled Low during reset, the controller has unpredictable behavior. If this happens, remove one or both of the pull-down resistors, and apply  $\overline{\text{RST}}$  or power-cycle the part.

In addition, it is possible to create a software sequence that prevents the debugger from connecting to the Stellaris<sup>®</sup> microcontroller. If the program code loaded into flash immediately changes the JTAG pins to their GPIO functionality, the debugger may not have enough time to connect and halt the controller before the JTAG pin functionality switches. This may lock the debugger out of the part. This can be avoided with a software routine that restores JTAG functionality based on an external or software trigger.

The commit control registers provide a layer of protection against accidental programming of critical hardware peripherals. Writes to protected bits of the **GPIO Alternate Function Select (GPIO AFSEL)** register (see page 173) are not committed to storage unless the **GPIO Lock (GPIO LOCK)** register (see page 183) has been unlocked and the appropriate bits of the **GPIO Commit (GPIO CR)** register (see page 184) have been set to 1.

#### **Recovering a "Locked" Device**

If software configures any of the JTAG/SWD pins as GPIO and loses the ability to communicate with the debugger, there is a debug sequence that can be used to recover the device. Performing a total of ten JTAG-to-SWD and SWD-to-JTAG switch sequences while holding the device in reset mass erases the flash memory. The sequence to recover the device is:

1. Assert and hold the  $\overline{\text{RST}}$  signal.
2. Perform the JTAG-to-SWD switch sequence.
3. Perform the SWD-to-JTAG switch sequence.
4. Perform the JTAG-to-SWD switch sequence.
5. Perform the SWD-to-JTAG switch sequence.
6. Perform the JTAG-to-SWD switch sequence.
7. Perform the SWD-to-JTAG switch sequence.
8. Perform the JTAG-to-SWD switch sequence.
9. Perform the SWD-to-JTAG switch sequence.
10. Perform the JTAG-to-SWD switch sequence.
11. Perform the SWD-to-JTAG switch sequence.

12. Release the  $\overline{\text{RST}}$  signal.

The JTAG-to-SWD and SWD-to-JTAG switch sequences are described in “ARM Serial Wire Debug (SWD)” on page 50. When performing switch sequences for the purpose of recovering the debug capabilities of the device, only steps 1 and 2 of the switch sequence need to be performed.

#### 5.2.4.2 ARM Serial Wire Debug (SWD)

In order to seamlessly integrate the ARM Serial Wire Debug (SWD) functionality, a serial-wire debugger must be able to connect to the Cortex-M3 core without having to perform, or have any knowledge of, JTAG cycles. This is accomplished with a SWD preamble that is issued before the SWD session begins.

The preamble used to enable the SWD interface of the SWJ-DP module starts with the TAP controller in the Test-Logic-Reset state. From here, the preamble sequences the TAP controller through the following states: Run Test Idle, Select DR, Select IR, Test Logic Reset, Test Logic Reset, Run Test Idle, Run Test Idle, Select DR, Select IR, Test Logic Reset, Test Logic Reset, Run Test Idle, Run Test Idle, Select DR, Select IR, and Test Logic Reset states.

Stepping through this sequences of the TAP state machine enables the SWD interface and disables the JTAG interface. For more information on this operation and the SWD interface, see the *ARM® Cortex™-M3 Technical Reference Manual* and the *ARM® CoreSight Technical Reference Manual*.

Because this sequence is a valid series of JTAG operations that could be issued, the ARM JTAG TAP controller is not fully compliant to the *IEEE Standard 1149.1*. This is the only instance where the ARM JTAG TAP controller does not meet full compliance with the specification. Due to the low probability of this sequence occurring during normal operation of the TAP controller, it should not affect normal performance of the JTAG interface.

##### **JTAG-to-SWD Switching**

To switch the operating mode of the Debug Access Port (DAP) from JTAG to SWD mode, the external debug hardware must send a switch sequence to the device. The 16-bit switch sequence for switching to SWD mode is defined as b1110011110011110, transmitted LSB first. This can also be represented as 16'hE79E when transmitted LSB first. The complete switch sequence should consist of the following transactions on the TCK/SWCLK and TMS/SWDIO signals:

1. Send at least 50 TCK/SWCLK cycles with TMS/SWDIO set to 1. This ensures that both JTAG and SWD are in their reset/idle states.
2. Send the 16-bit JTAG-to-SWD switch sequence, 16'hE79E.
3. Send at least 50 TCK/SWCLK cycles with TMS/SWDIO set to 1. This ensures that if SWJ-DP was already in SWD mode, before sending the switch sequence, the SWD goes into the line reset state.

##### **SWD-to-JTAG Switching**

To switch the operating mode of the Debug Access Port (DAP) from SWD to JTAG mode, the external debug hardware must send a switch sequence to the device. The 16-bit switch sequence for switching to JTAG mode is defined as b1110011110011110, transmitted LSB first. This can also be represented as 16'hE73C when transmitted LSB first. The complete switch sequence should consist of the following transactions on the TCK/SWCLK and TMS/SWDIO signals:

1. Send at least 50 TCK/SWCLK cycles with TMS/SWDIO set to 1. This ensures that both JTAG and SWD are in their reset/idle states.

2. Send the 16-bit SWD-to-JTAG switch sequence, 16'hE73C.
3. Send at least 5 TCK/SWCLK cycles with TMS/SWDIO set to 1. This ensures that if SWJ-DP was already in JTAG mode, before sending the switch sequence, the JTAG goes into the Test Logic Reset state.

## 5.3 Initialization and Configuration

After a Power-On-Reset or an external reset ( $\overline{\text{RST}}$ ), the JTAG pins are automatically configured for JTAG communication. No user-defined initialization or configuration is needed. However, if the user application changes these pins to their GPIO function, they must be configured back to their JTAG functionality before JTAG communication can be restored. This is done by enabling the five JTAG pins ( $\text{PB7}$  and  $\text{PC}[3:0]$ ) for their alternate function using the **GPIOAFSEL** register.

## 5.4 Register Descriptions

There are no APB-accessible registers in the JTAG TAP Controller or Shift Register chains. The registers within the JTAG controller are all accessed serially through the TAP Controller. The registers can be broken down into two main categories: Instruction Registers and Data Registers.

### 5.4.1 Instruction Register (IR)

The JTAG TAP Instruction Register (IR) is a four-bit serial scan chain with a parallel load register connected between the JTAG TDI and TDO pins. When the TAP Controller is placed in the correct states, bits can be shifted into the Instruction Register. Once these bits have been shifted into the chain and updated, they are interpreted as the current instruction. The decode of the Instruction Register bits is shown in Table 5-2 on page 51. A detailed explanation of each instruction, along with its associated Data Register, follows.

**Table 5-2. JTAG Instruction Register Commands**

IR[3:0]	Instruction	Description
0000	EXTEST	Drives the values preloaded into the Boundary Scan Chain by the SAMPLE/PRELOAD instruction onto the pads.
0001	INTEST	Drives the values preloaded into the Boundary Scan Chain by the SAMPLE/PRELOAD instruction into the controller.
0010	SAMPLE / PRELOAD	Captures the current I/O values and shifts the sampled values out of the Boundary Scan Chain while new preload data is shifted in.
1000	ABORT	Shifts data into the ARM Debug Port Abort Register.
1010	DPACC	Shifts data into and out of the ARM DP Access Register.
1011	APACC	Shifts data into and out of the ARM AC Access Register.
1110	IDCODE	Loads manufacturing information defined by the <i>IEEE Standard 1149.1</i> into the IDCODE chain and shifts it out.
1111	BYPASS	Connects TDI to TDO through a single Shift Register chain.
All Others	Reserved	Defaults to the BYPASS instruction to ensure that TDI is always connected to TDO.

#### 5.4.1.1 EXTEST Instruction

The EXTEST instruction does not have an associated Data Register chain. The EXTEST instruction uses the data that has been preloaded into the Boundary Scan Data Register using the SAMPLE/PRELOAD instruction. When the EXTEST instruction is present in the Instruction Register, the preloaded data in the Boundary Scan Data Register associated with the outputs and output enables are used to drive the GPIO pads rather than the signals coming from the core. This allows

tests to be developed that drive known values out of the controller, which can be used to verify connectivity.

#### 5.4.1.2 INTEST Instruction

The INTEST instruction does not have an associated Data Register chain. The INTEST instruction uses the data that has been preloaded into the Boundary Scan Data Register using the SAMPLE/PRELOAD instruction. When the INTEST instruction is present in the Instruction Register, the preloaded data in the Boundary Scan Data Register associated with the inputs are used to drive the signals going into the core rather than the signals coming from the GPIO pads. This allows tests to be developed that drive known values into the controller, which can be used for testing. It is important to note that although the  $\overline{\text{RST}}$  input pin is on the Boundary Scan Data Register chain, it is only observable.

#### 5.4.1.3 SAMPLE/PRELOAD Instruction

The SAMPLE/PRELOAD instruction connects the Boundary Scan Data Register chain between TDI and TDO. This instruction samples the current state of the pad pins for observation and preloads new test data. Each GPIO pad has an associated input, output, and output enable signal. When the TAP controller enters the Capture DR state during this instruction, the input, output, and output-enable signals to each of the GPIO pads are captured. These samples are serially shifted out of TDO while the TAP controller is in the Shift DR state and can be used for observation or comparison in various tests.

While these samples of the inputs, outputs, and output enables are being shifted out of the Boundary Scan Data Register, new data is being shifted into the Boundary Scan Data Register from TDI. Once the new data has been shifted into the Boundary Scan Data Register, the data is saved in the parallel load registers when the TAP controller enters the Update DR state. This update of the parallel load register preloads data into the Boundary Scan Data Register that is associated with each input, output, and output enable. This preloaded data can be used with the EXTEST and INTEST instructions to drive data into or out of the controller. Please see “Boundary Scan Data Register” on page 54 for more information.

#### 5.4.1.4 ABORT Instruction

The ABORT instruction connects the associated ABORT Data Register chain between TDI and TDO. This instruction provides read and write access to the ABORT Register of the ARM Debug Access Port (DAP). Shifting the proper data into this Data Register clears various error bits or initiates a DAP abort of a previous request. Please see the “ABORT Data Register” on page 54 for more information.

#### 5.4.1.5 DPACC Instruction

The DPACC instruction connects the associated DPACC Data Register chain between TDI and TDO. This instruction provides read and write access to the DPACC Register of the ARM Debug Access Port (DAP). Shifting the proper data into this register and reading the data output from this register allows read and write access to the ARM debug and status registers. Please see “DPACC Data Register” on page 54 for more information.

#### 5.4.1.6 APACC Instruction

The APACC instruction connects the associated APACC Data Register chain between TDI and TDO. This instruction provides read and write access to the APACC Register of the ARM Debug Access Port (DAP). Shifting the proper data into this register and reading the data output from this register allows read and write access to internal components and buses through the Debug Port. Please see “APACC Data Register” on page 54 for more information.

### 5.4.1.7 IDCODE Instruction

The IDCODE instruction connects the associated IDCODE Data Register chain between TDI and TDO. This instruction provides information on the manufacturer, part number, and version of the ARM core. This information can be used by testing equipment and debuggers to automatically configure their input and output data streams. IDCODE is the default instruction that is loaded into the JTAG Instruction Register when a power-on-reset (POR) is asserted,  $\overline{\text{TRST}}$  is asserted, or the Test-Logic-Reset state is entered. Please see “IDCODE Data Register” on page 53 for more information.

### 5.4.1.8 BYPASS Instruction

The BYPASS instruction connects the associated BYPASS Data Register chain between TDI and TDO. This instruction is used to create a minimum length serial path between the TDI and TDO ports. The BYPASS Data Register is a single-bit shift register. This instruction improves test efficiency by allowing components that are not needed for a specific test to be bypassed in the JTAG scan chain by loading them with the BYPASS instruction. Please see “BYPASS Data Register” on page 53 for more information.

## 5.4.2 Data Registers

The JTAG module contains six Data Registers. These include: IDCODE, BYPASS, Boundary Scan, APACC, DPACC, and ABORT serial Data Register chains. Each of these Data Registers is discussed in the following sections.

### 5.4.2.1 IDCODE Data Register

The format for the 32-bit IDCODE Data Register defined by the *IEEE Standard 1149.1* is shown in Figure 5-3 on page 53. The standard requires that every JTAG-compliant device implement either the IDCODE instruction or the BYPASS instruction as the default instruction. The LSB of the IDCODE Data Register is defined to be a 1 to distinguish it from the BYPASS instruction, which has an LSB of 0. This allows auto configuration test tools to determine which instruction is the default instruction.

The major uses of the JTAG port are for manufacturer testing of component assembly, and program development and debug. To facilitate the use of auto-configuration debug tools, the IDCODE instruction outputs a value of 0x3BA00477. This value indicates an ARM Cortex-M3, Version 1 processor. This allows the debuggers to automatically configure themselves to work correctly with the Cortex-M3 during debug.

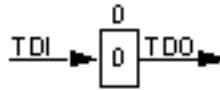
**Figure 5-3. IDCODE Register Format**



### 5.4.2.2 BYPASS Data Register

The format for the 1-bit BYPASS Data Register defined by the *IEEE Standard 1149.1* is shown in Figure 5-4 on page 54. The standard requires that every JTAG-compliant device implement either the BYPASS instruction or the IDCODE instruction as the default instruction. The LSB of the BYPASS Data Register is defined to be a 0 to distinguish it from the IDCODE instruction, which has an LSB of 1. This allows auto configuration test tools to determine which instruction is the default instruction.

Figure 5-4. BYPASS Register Format

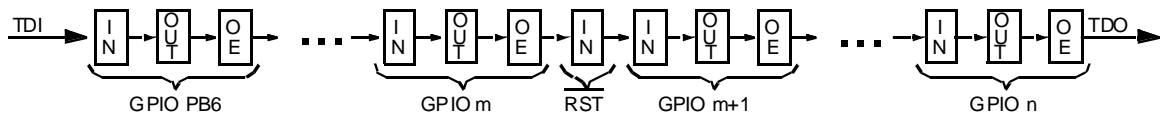


### 5.4.2.3 Boundary Scan Data Register

The format of the Boundary Scan Data Register is shown in Figure 5-5 on page 54. Each GPIO pin, in a counter-clockwise direction from the JTAG port pins, is included in the Boundary Scan Data Register. Each GPIO pin has three associated digital signals that are included in the chain. These signals are input, output, and output enable, and are arranged in that order as can be seen in the figure. In addition to the GPIO pins, the controller reset pin,  $\overline{RST}$ , is included in the chain. Because the reset pin is always an input, only the input signal is included in the Data Register chain.

When the Boundary Scan Data Register is accessed with the SAMPLE/PRELOAD instruction, the input, output, and output enable from each digital pad are sampled and then shifted out of the chain to be verified. The sampling of these values occurs on the rising edge of TCK in the Capture DR state of the TAP controller. While the sampled data is being shifted out of the Boundary Scan chain in the Shift DR state of the TAP controller, new data can be preloaded into the chain for use with the EXTEST and INTEST instructions. These instructions either force data out of the controller, with the EXTEST instruction, or into the controller, with the INTEST instruction.

Figure 5-5. Boundary Scan Register Format



For detailed information on the order of the input, output, and output enable bits for each of the GPIO ports, please refer to the Stellaris® Family Boundary Scan Description Language (BSDL) files, downloadable from [www.luminarymicro.com](http://www.luminarymicro.com).

### 5.4.2.4 APACC Data Register

The format for the 35-bit APACC Data Register defined by ARM is described in the *ARM® Cortex™-M3 Technical Reference Manual*.

### 5.4.2.5 DPACC Data Register

The format for the 35-bit DPACC Data Register defined by ARM is described in the *ARM® Cortex™-M3 Technical Reference Manual*.

### 5.4.2.6 ABORT Data Register

The format for the 35-bit ABORT Data Register defined by ARM is described in the *ARM® Cortex™-M3 Technical Reference Manual*.

## 6 System Control

System control determines the overall operation of the device. It provides information about the device, controls the clocking to the core and individual peripherals, and handles reset detection and reporting.

### 6.1 Functional Description

The System Control module provides the following capabilities:

- Device identification, see “Device Identification” on page 55
- Local control, such as reset (see “Reset Control” on page 55), power (see “Power Control” on page 58) and clock control (see “Clock Control” on page 58)
- System control (Run, Sleep, and Deep-Sleep modes), see “System Control” on page 60

#### 6.1.1 Device Identification

Seven read-only registers provide software with information on the microcontroller, such as version, part number, SRAM size, flash size, and other features. See the **DID0**, **DID1**, and **DC0-DC4** registers.

#### 6.1.2 Reset Control

This section discusses aspects of hardware functions during reset as well as system software requirements following the reset sequence.

##### 6.1.2.1 CMOD0 and CMOD1 Test-Mode Control Pins

Two pins, **CMOD0** and **CMOD1**, are defined for use by Luminary Micro for testing the devices during manufacture. They have no end-user function and should not be used. The **CMOD** pins should be connected to ground.

##### 6.1.2.2 Reset Sources

The controller has five sources of reset:

1. External reset input pin ( $\overline{\text{RST}}$ ) assertion, see “ $\overline{\text{RST}}$  Pin Assertion” on page 55.
2. Power-on reset (POR), see “Power-On Reset (POR)” on page 56.
3. Internal brown-out (BOR) detector, see “Brown-Out Reset (BOR)” on page 56.
4. Software-initiated reset (with the software reset registers), see “Software Reset” on page 57.
5. A watchdog timer reset condition violation, see “Watchdog Timer Reset” on page 57.

After a reset, the **Reset Cause (RESC)** register is set with the reset cause. The bits in this register are sticky and maintain their state across multiple reset sequences, except when an internal POR is the cause, and then all the other bits in the **RESC** register are cleared except for the POR indicator.

##### 6.1.2.3 $\overline{\text{RST}}$ Pin Assertion

The external reset pin ( $\overline{\text{RST}}$ ) resets the controller. This resets the core and all the peripherals except the JTAG TAP controller (see “JTAG Interface” on page 44). The external reset sequence is as follows:

1. The external reset pin ( $\overline{RST}$ ) is asserted and then de-asserted.
2. The internal reset is released and the core loads from memory the initial stack pointer, the initial program counter, the first instruction designated by the program counter, and begins execution. A few clocks cycles from  $\overline{RST}$  de-assertion to the start of the reset sequence is necessary for synchronization.

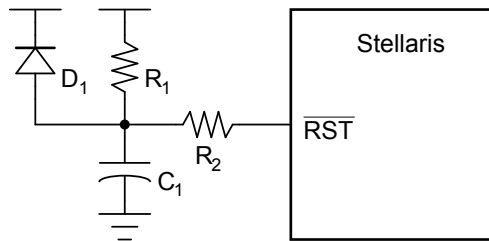
The external reset timing is shown in Figure 20-10 on page 441.

#### 6.1.2.4 Power-On Reset (POR)

The Power-On Reset (POR) circuit monitors the power supply voltage ( $V_{DD}$ ). The POR circuit generates a reset signal to the internal logic when the power supply ramp reaches a threshold value ( $V_{TH}$ ). If the application only uses the POR circuit, the  $\overline{RST}$  input needs to be connected to the power supply ( $V_{DD}$ ) through a pull-up resistor (1K to 10K  $\Omega$ ).

The device must be operating within the specified operating parameters at the point when the on-chip power-on reset pulse is complete. The 3.3-V power supply to the device must reach 3.0 V within 10 msec of it crossing 2.0 V to guarantee proper operation. For applications that require the use of an external reset to hold the device in reset longer than the internal POR, the  $\overline{RST}$  input may be used with the circuit as shown in Figure 6-1 on page 56.

**Figure 6-1. External Circuitry to Extend Reset**



The  $R_1$  and  $C_1$  components define the power-on delay. The  $R_2$  resistor mitigates any leakage from the  $\overline{RST}$  input. The diode ( $D_1$ ) discharges  $C_1$  rapidly when the power supply is turned off.

The Power-On Reset sequence is as follows:

1. The controller waits for the later of external reset ( $\overline{RST}$ ) or internal POR to go inactive.
2. The internal reset is released and the core loads from memory the initial stack pointer, the initial program counter, the first instruction designated by the program counter, and begins execution.

The internal POR is only active on the initial power-up of the controller. The Power-On Reset timing is shown in Figure 20-11 on page 442.

**Note:** The power-on reset also resets the JTAG controller. An external reset does not.

#### 6.1.2.5 Brown-Out Reset (BOR)

A drop in the input voltage resulting in the assertion of the internal brown-out detector can be used to reset the controller. This is initially disabled and may be enabled by software.

The system provides a brown-out detection circuit that triggers if the power supply ( $V_{DD}$ ) drops below a brown-out threshold voltage ( $V_{BTH}$ ). If a brown-out condition is detected, the system may generate a controller interrupt or a system reset.



Brown-out resets are controlled with the **Power-On and Brown-Out Reset Control (PBORCTL)** register. The `BORIOR` bit in the **PBORCTL** register must be set for a brown-out condition to trigger a reset.

The brown-out reset is equivalent to an assertion of the external  $\overline{RST}$  input and the reset is held active until the proper  $V_{DD}$  level is restored. The **RESC** register can be examined in the reset interrupt handler to determine if a Brown-Out condition was the cause of the reset, thus allowing software to determine what actions are required to recover.

The internal Brown-Out Reset timing is shown in Figure 20-12 on page 442.

### 6.1.2.6 Software Reset

Software can reset a specific peripheral or generate a reset to the entire system .

Peripherals can be individually reset by software via three registers that control reset signals to each peripheral (see the **SRCRn** registers). If the bit position corresponding to a peripheral is set and subsequently cleared, the peripheral is reset. The encoding of the reset registers is consistent with the encoding of the clock gating control for peripherals and on-chip functions (see “System Control” on page 60). Note that all reset signals for all clocks of the specified unit are asserted as a result of a software-initiated reset.

The entire system can be reset by software by setting the `SYSRESETREQ` bit in the Cortex-M3 Application Interrupt and Reset Control register resets the entire system including the core. The software-initiated system reset sequence is as follows:

1. A software system reset is initiated by writing the `SYSRESETREQ` bit in the ARM Cortex-M3 Application Interrupt and Reset Control register.
2. An internal reset is asserted.
3. The internal reset is deasserted and the controller loads from memory the initial stack pointer, the initial program counter, and the first instruction designated by the program counter, and then begins execution.

The software-initiated system reset timing is shown in Figure 20-13 on page 442.

### 6.1.2.7 Watchdog Timer Reset

The watchdog timer module's function is to prevent system hangs. The watchdog timer can be configured to generate an interrupt to the controller on its first time-out, and to generate a reset signal on its second time-out.

After the first time-out event, the 32-bit counter is reloaded with the value of the **Watchdog Timer Load (WDTLOAD)** register, and the timer resumes counting down from that value. If the timer counts down to its zero state again before the first time-out interrupt is cleared, and the reset signal has been enabled, the watchdog timer asserts its reset signal to the system. The watchdog timer reset sequence is as follows:

1. The watchdog timer times out for the second time without being serviced.
2. An internal reset is asserted.
3. The internal reset is released and the controller loads from memory the initial stack pointer, the initial program counter, the first instruction designated by the program counter, and begins execution.

The watchdog reset timing is shown in Figure 20-14 on page 442.

### 6.1.3 Power Control

The Stellaris<sup>®</sup> microcontroller provides an integrated LDO regulator that may be used to provide power to the majority of the controller's internal logic. The LDO regulator provides software a mechanism to adjust the regulated value, in small increments (VSTEP), over the range of 2.25 V to 2.75 V (inclusive)—or  $2.5\text{ V} \pm 10\%$ . The adjustment is made by changing the value of the VADJ field in the **LDO Power Control (LDOPCTL)** register.

**Note:** The use of the LDO is optional. The internal logic may be supplied by the on-chip LDO or by an external regulator. If the LDO is used, the LDO output pin is connected to the VDD25 pins on the printed circuit board. The LDO requires decoupling capacitors on the printed circuit board. If an external regulator is used, it is strongly recommended that the external regulator supply the controller only and not be shared with other devices on the printed circuit board.

### 6.1.4 Clock Control

System control determines the control of clocks in this part.

#### 6.1.4.1 Fundamental Clock Sources

There are four clock sources for use in the device:

- **Internal Oscillator (IOSC):** The internal oscillator is an on-chip clock source. It does not require the use of any external components. The frequency of the internal oscillator is  $12\text{ MHz} \pm 30\%$ . Applications that do not depend on accurate clock sources may use this clock source to reduce system cost. The internal oscillator is the clock source the device uses during and following POR. If the main oscillator is required, software must enable the main oscillator following reset and allow the main oscillator to stabilize before changing the clock reference.
- **Main Oscillator:** The main oscillator provides a frequency-accurate clock source by one of two means: an external single-ended clock source is connected to the OSC0 input pin, or an external crystal is connected across the OSC0 input and OSC1 output pins. The crystal value allowed depends on whether the main oscillator is used as the clock reference source to the PLL. If so, the crystal must be one of the supported frequencies between 3.579545 MHz through 8.192 MHz (inclusive). If the PLL is not being used, the crystal may be any one of the supported frequencies between 1 MHz and 8.192 MHz. The single-ended clock source range is from DC through the specified speed of the device. The supported crystals are listed in page 71 on page ?.
- **Internal 30-kHz Oscillator:** The internal 30-kHz oscillator is similar to the internal oscillator, except that it provides an operational frequency of  $30\text{ kHz} \pm 30\%$ . It is intended for use during Deep-Sleep power-saving modes. This power-savings mode benefits from reduced internal switching and also allows the main oscillator to be powered down.
- **External Real-Time Oscillator:** The external real-time oscillator provides a low-frequency, accurate clock reference. It is intended to provide the system with a real-time clock source. The real-time oscillator is part of the Hibernation Module (“Hibernation Module” on page 114) and may also provide an accurate source of Deep-Sleep or Hibernate mode power savings.

The internal system clock (sysclk), is derived from any of the four sources plus two others: the output of the internal PLL, and the internal oscillator divided by four ( $3\text{ MHz} \pm 30\%$ ). The frequency of the PLL clock reference must be in the range of 3.579545 MHz to 8.192 MHz (inclusive).

The **Run-Mode Clock Configuration (RCC)** and **Run-Mode Clock Configuration 2 (RCC2)** registers provide control for the system clock. The **RCC2** register is provided to extend fields that offer additional encodings over the **RCC** register. When used, the **RCC2** register field values are used by the logic over the corresponding field in the **RCC** register. In particular, **RCC2** provides for a larger assortment of clock configuration options.

#### 6.1.4.2 Crystal Configuration for the Main Oscillator (MOSC)

The main oscillator supports the use of a select number of crystals. If the main oscillator is used by the PLL as a reference clock, the supported range of crystals is 3.579545 to 8.192 MHz, otherwise, the range of supported crystals is 1 to 8.192 MHz.

page 71 on page ? describes the available crystal choices and default programming values.

Software configures the **RCC** register `XTAL` field with the crystal number. If the PLL is used in the design, the `XTAL` field value is internally translated to the PLL settings.

#### 6.1.4.3 PLL Frequency Configuration

The PLL is disabled by default during power-on reset and is enabled later by software if required. Software configures the PLL input reference clock source, specifies the output divisor to set the system clock frequency, and enables the PLL to drive the output.

If the main oscillator provides the clock reference to the PLL, the translation provided by hardware and used to program the PLL is available for software in the **XTAL to PLL Translation (PLLCFG)** register (see page 75). The internal translation provides a translation within  $\pm 1\%$  of the targeted PLL VCO frequency.

page 71 on page ? describes the available crystal choices and default programming of the **PLLCFG** register. The crystal number is written into the `XTAL` field of the **Run-Mode Clock Configuration (RCC)** register. Any time the `XTAL` field changes, the new settings are translated and the internal PLL settings are updated.

#### 6.1.4.4 PLL Modes

The PLL has two modes of operation: Normal and Power-Down

- Normal: The PLL multiplies the input clock reference and drives the output.
- Power-Down: Most of the PLL internal circuitry is disabled and the PLL does not drive the output.

The modes are programmed using the **RCC/RCC2** register fields (see page 71 and page 76).

#### 6.1.4.5 PLL Operation

If the PLL configuration is changed, the PLL output frequency is unstable until it reconverges (relocks) to the new setting. The time between the configuration change and relock is  $T_{\text{READY}}$  (see Table 20-5 on page 434). During this time, the PLL is not usable as a clock reference.

The PLL is changed by one of the following:

- Change to the `XTAL` value in the **RCC** register—writes of the same value do not cause a relock.
- Change in the PLL from Power-Down to Normal mode.

A counter is defined to measure the  $T_{\text{READY}}$  requirement. The counter is clocked by the main oscillator. The range of the main oscillator has been taken into account and the down counter is set to 0x1200 (that is,  $\sim 600 \mu\text{s}$  at an 8.192 MHz external oscillator clock). Hardware is provided to keep

the PLL from being used as a system clock until the  $T_{\text{READY}}$  condition is met after one of the two changes above. It is the user's responsibility to have a stable clock source (like the main oscillator) before the **RCC/RCC2** register is switched to use the PLL.

### 6.1.5 System Control

For power-savings purposes, the **RCGCn**, **SCGCn**, and **DCGCn** registers control the clock gating logic for each peripheral or block in the system while the controller is in Run, Sleep, and Deep-Sleep mode, respectively.

In Run mode, the processor executes code. In Sleep mode, the clock frequency of the active peripherals is unchanged, but the processor is not clocked and therefore no longer executes code. In Deep-Sleep mode, the clock frequency of the active peripherals may change (depending on the Run mode clock configuration) in addition to the processor clock being stopped. An interrupt returns the device to Run mode from one of the sleep modes; the sleep modes are entered on request from the code. Each mode is described in more detail below.

There are four levels of operation for the device defined as:

- **Run Mode.** Run mode provides normal operation of the processor and all of the peripherals that are currently enabled by the **RCGCn** registers. The system clock can be any of the available clock sources including the PLL.
- **Sleep Mode.** Sleep mode is entered by the Cortex-M3 core executing a **WFI** (Wait for Interrupt) instruction. Any properly configured interrupt event in the system will bring the processor back into Run mode. See the system control NVIC section of the *ARM® Cortex™-M3 Technical Reference Manual* for more details.

In Sleep mode, the Cortex-M3 processor core and the memory subsystem are not clocked. Peripherals are clocked that are enabled in the **SCGCn** register when auto-clock gating is enabled (see the **RCC** register) or the **RCGCn** register when the auto-clock gating is disabled. The system clock has the same source and frequency as that during Run mode.

- **Deep-Sleep Mode.** Deep-Sleep mode is entered by first writing the Deep Sleep Enable bit in the ARM Cortex-M3 NVIC system control register and then executing a **WFI** instruction. Any properly configured interrupt event in the system will bring the processor back into Run mode. See the system control NVIC section of the *ARM® Cortex™-M3 Technical Reference Manual* for more details.

The Cortex-M3 processor core and the memory subsystem are not clocked. Peripherals are clocked that are enabled in the **DCGCn** register when auto-clock gating is enabled (see the **RCC** register) or the **RCGCn** register when auto-clock gating is disabled. The system clock source is the main oscillator by default or the internal oscillator specified in the **DSLCLKCFG** register if one is enabled. When the **DSLCLKCFG** register is used, the internal oscillator is powered up, if necessary, and the main oscillator is powered down. If the PLL is running at the time of the **WFI** instruction, hardware will power the PLL down and override the **SYSDIV** field of the active **RCC/RCC2** register to be /16 or /64, respectively. When the Deep-Sleep exit event occurs, hardware brings the system clock back to the source and frequency it had at the onset of Deep-Sleep mode before enabling the clocks that had been stopped during the Deep-Sleep duration.

- **Hibernate Mode.** In this mode, the power supplies are turned off to the main part of the device and only the Hibernation module's circuitry is active. An external wake event or RTC event is required to bring the device back to Run mode. The Cortex-M3 processor and peripherals outside of the Hibernation module see a normal "power on" sequence and the processor starts running

code. It can determine that it has been restarted from Hibernate mode by inspecting the Hibernation module registers.

## 6.2 Initialization and Configuration

The PLL is configured using direct register writes to the **RCC/RCC2** register. If the **RCC2** register is being used, the **USERCC2** bit must be set and the appropriate **RCC2** bit/field is used. The steps required to successfully change the PLL-based system clock are:

1. Bypass the PLL and system clock divider by setting the **BYPASS** bit and clearing the **USESYS** bit in the **RCC** register. This configures the system to run off a “raw” clock source (using the main oscillator or internal oscillator) and allows for the new PLL configuration to be validated before switching the system clock to the PLL.
2. Select the crystal value (**XTAL**) and oscillator source (**OSCSRC**), and clear the **PWRDN** bit in **RCC/RCC2**. Setting the **XTAL** field automatically pulls valid PLL configuration data for the appropriate crystal, and clearing the **PWRDN** bit powers and enables the PLL and its output.
3. Select the desired system divider (**SYSDIV**) in **RCC/RCC2** and set the **USESYS** bit in **RCC**. The **SYSDIV** field determines the system frequency for the microcontroller.
4. Wait for the PLL to lock by polling the **PLLLRIS** bit in the **Raw Interrupt Status (RIS)** register.
5. Enable use of the PLL by clearing the **BYPASS** bit in **RCC/RCC2**.

## 6.3 Register Map

Table 6-1 on page 61 lists the System Control registers, grouped by function. The offset listed is a hexadecimal increment to the register’s address, relative to the System Control base address of 0x400F.E000.

**Note:** Spaces in the System Control register space that are not used are reserved for future or internal use by Luminary Micro, Inc. Software should not modify any reserved memory address.

**Table 6-1. System Control Register Map**

Offset	Name	Type	Reset	Description	See page
0x000	DID0	RO	-	Device Identification 0	63
0x004	DID1	RO	-	Device Identification 1	79
0x008	DC0	RO	0x003F.001F	Device Capabilities 0	81
0x010	DC1	RO	0x0001.33FF	Device Capabilities 1	82
0x014	DC2	RO	0x070F.5037	Device Capabilities 2	84
0x018	DC3	RO	0x3FFF.7FC0	Device Capabilities 3	86
0x01C	DC4	RO	0x0000.00FF	Device Capabilities 4	88
0x030	PBORCTL	R/W	0x0000.7FFD	Brown-Out Reset Control	65
0x034	LDOPCTL	R/W	0x0000.0000	LDO Power Control	66
0x040	SRCR0	R/W	0x00000000	Software Reset Control 0	110

Offset	Name	Type	Reset	Description	See page
0x044	SRCR1	R/W	0x00000000	Software Reset Control 1	111
0x048	SRCR2	R/W	0x00000000	Software Reset Control 2	113
0x050	RIS	RO	0x0000.0000	Raw Interrupt Status	67
0x054	IMC	R/W	0x0000.0000	Interrupt Mask Control	68
0x058	MISC	R/W1C	0x0000.0000	Masked Interrupt Status and Clear	69
0x05C	RESC	R/W	-	Reset Cause	70
0x060	RCC	R/W	0x07A0.3AD1	Run-Mode Clock Configuration	71
0x064	PLLCFG	RO	-	XTAL to PLL Translation	75
0x070	RCC2	R/W	0x0780.2800	Run-Mode Clock Configuration 2	76
0x100	RCGC0	R/W	0x00000040	Run Mode Clock Gating Control Register 0	89
0x104	RCGC1	R/W	0x00000000	Run Mode Clock Gating Control Register 1	95
0x108	RCGC2	R/W	0x00000000	Run Mode Clock Gating Control Register 2	104
0x110	SCGC0	R/W	0x00000040	Sleep Mode Clock Gating Control Register 0	91
0x114	SCGC1	R/W	0x00000000	Sleep Mode Clock Gating Control Register 1	98
0x118	SCGC2	R/W	0x00000000	Sleep Mode Clock Gating Control Register 2	106
0x120	DCGC0	R/W	0x00000040	Deep Sleep Mode Clock Gating Control Register 0	93
0x124	DCGC1	R/W	0x00000000	Deep Sleep Mode Clock Gating Control Register 1	101
0x128	DCGC2	R/W	0x00000000	Deep Sleep Mode Clock Gating Control Register 2	108
0x144	DSLPCCLKCFG	R/W	0x0780.0000	Deep Sleep Clock Configuration	78

## 6.4 Register Descriptions

All addresses given are relative to the System Control base address of 0x400F.E000.

## Register 1: Device Identification 0 (DID0), offset 0x000

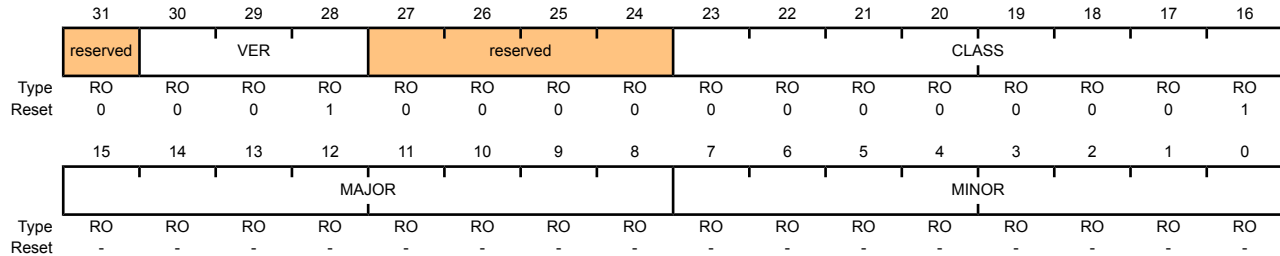
This register identifies the version of the device.

### Device Identification 0 (DID0)

Base 0x400F.E000

Offset 0x000

Type RO, reset -



Bit/Field	Name	Type	Reset	Description						
31	reserved	RO	0	Software should not rely on the value of a reserved bit. To provide compatibility with future products, the value of a reserved bit should be preserved across a read-modify-write operation.						
30:28	VER	RO	0x1	<p>DID0 Version</p> <p>This field defines the <b>DID0</b> register format version. The version number is numeric. The value of the <code>VER</code> field is encoded as follows:</p> <table border="1"> <thead> <tr> <th>Value</th> <th>Description</th> </tr> </thead> <tbody> <tr> <td>0x1</td> <td>First revision of the <b>DID0</b> register format, for Stellaris® Fury-class devices.</td> </tr> </tbody> </table>	Value	Description	0x1	First revision of the <b>DID0</b> register format, for Stellaris® Fury-class devices.		
Value	Description									
0x1	First revision of the <b>DID0</b> register format, for Stellaris® Fury-class devices.									
27:24	reserved	RO	0x0	Software should not rely on the value of a reserved bit. To provide compatibility with future products, the value of a reserved bit should be preserved across a read-modify-write operation.						
23:16	CLASS	RO	0x1	<p>Device Class</p> <p>The <code>CLASS</code> field value identifies the internal design from which all mask sets are generated for all devices in a particular product line. The <code>CLASS</code> field value is changed for new product lines, for changes in fab process (for example, a remap or shrink), or any case where the <code>MAJOR</code> or <code>MINOR</code> fields require differentiation from prior devices. The value of the <code>CLASS</code> field is encoded as follows (all other encodings are reserved):</p> <table border="1"> <thead> <tr> <th>Value</th> <th>Description</th> </tr> </thead> <tbody> <tr> <td>0x0</td> <td>Stellaris® Sandstorm-class devices.</td> </tr> <tr> <td>0x1</td> <td>Stellaris® Fury-class devices.</td> </tr> </tbody> </table>	Value	Description	0x0	Stellaris® Sandstorm-class devices.	0x1	Stellaris® Fury-class devices.
Value	Description									
0x0	Stellaris® Sandstorm-class devices.									
0x1	Stellaris® Fury-class devices.									

Bit/Field	Name	Type	Reset	Description								
15:8	MAJOR	RO	-	<p>Major Revision</p> <p>This field specifies the major revision number of the device. The major revision reflects changes to base layers of the design. The major revision number is indicated in the part number as a letter (A for first revision, B for second, and so on). This field is encoded as follows:</p> <table><thead><tr><th>Value</th><th>Description</th></tr></thead><tbody><tr><td>0x0</td><td>Revision A (initial device)</td></tr><tr><td>0x1</td><td>Revision B (first base layer revision)</td></tr><tr><td>0x2</td><td>Revision C (second base layer revision)</td></tr></tbody></table> <p>and so on.</p>	Value	Description	0x0	Revision A (initial device)	0x1	Revision B (first base layer revision)	0x2	Revision C (second base layer revision)
Value	Description											
0x0	Revision A (initial device)											
0x1	Revision B (first base layer revision)											
0x2	Revision C (second base layer revision)											
7:0	MINOR	RO	-	<p>Minor Revision</p> <p>This field specifies the minor revision number of the device. The minor revision reflects changes to the metal layers of the design. The <code>MINOR</code> field value is reset when the <code>MAJOR</code> field is changed. This field is numeric and is encoded as follows:</p> <table><thead><tr><th>Value</th><th>Description</th></tr></thead><tbody><tr><td>0x0</td><td>Initial device, or a major revision update.</td></tr><tr><td>0x1</td><td>First metal layer change.</td></tr><tr><td>0x2</td><td>Second metal layer change.</td></tr></tbody></table> <p>and so on.</p>	Value	Description	0x0	Initial device, or a major revision update.	0x1	First metal layer change.	0x2	Second metal layer change.
Value	Description											
0x0	Initial device, or a major revision update.											
0x1	First metal layer change.											
0x2	Second metal layer change.											



**Register 2: Brown-Out Reset Control (PBORCTL), offset 0x030**

This register is responsible for controlling reset conditions after initial power-on reset.

**Brown-Out Reset Control (PBORCTL)**

Base 0x400F.E000

Offset 0x030

Type R/W, reset 0x0000.7FFD

	31	30	29	28	27	26	25	24	23	22	21	20	19	18	17	16	
	reserved																
Type	RO	RO	RO	RO	RO	RO	RO	RO	RO	RO	RO	RO	RO	RO	RO	RO	
Reset	0	0	0	0	0	0	0	0	0	0	0	0	0	0	0	0	
	15	14	13	12	11	10	9	8	7	6	5	4	3	2	1	0	
	reserved															BORIOR	reserved
Type	RO	RO	RO	RO	RO	RO	RO	RO	RO	RO	RO	RO	RO	RO	RO	R/W	RO
Reset	0	0	0	0	0	0	0	0	0	0	0	0	0	0	0	0	0

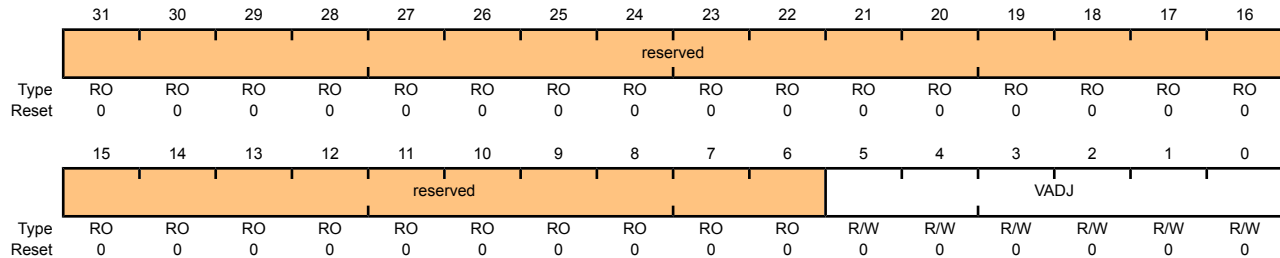
Bit/Field	Name	Type	Reset	Description
31:2	reserved	RO	0x0	Software should not rely on the value of a reserved bit. To provide compatibility with future products, the value of a reserved bit should be preserved across a read-modify-write operation.
1	BORIOR	R/W	0	BOR Interrupt or Reset  This bit controls how a BOR event is signaled to the controller. If set, a reset is signaled. Otherwise, an interrupt is signaled.
0	reserved	RO	0	Software should not rely on the value of a reserved bit. To provide compatibility with future products, the value of a reserved bit should be preserved across a read-modify-write operation.

### Register 3: LDO Power Control (LDOPCTL), offset 0x034

The V<sub>ADJ</sub> field in this register adjusts the on-chip output voltage (V<sub>OUT</sub>).

#### LDO Power Control (LDOPCTL)

Base 0x400F.E000  
 Offset 0x034  
 Type R/W, reset 0x0000.0000



Bit/Field	Name	Type	Reset	Description
31:6	reserved	RO	0	Software should not rely on the value of a reserved bit. To provide compatibility with future products, the value of a reserved bit should be preserved across a read-modify-write operation.

5:0	VADJ	R/W	0x0	LDO Output Voltage This field sets the on-chip output voltage. The programming values for the V <sub>ADJ</sub> field are provided below.
-----	------	-----	-----	---

Value	V <sub>OUT</sub> (V)
0x00	2.50
0x01	2.45
0x02	2.40
0x03	2.35
0x04	2.30
0x05	2.25
0x06-0x3F	Reserved
0x1B	2.75
0x1C	2.70
0x1D	2.65
0x1E	2.60
0x1F	2.55

## Register 4: Raw Interrupt Status (RIS), offset 0x050

Central location for system control raw interrupts. These are set and cleared by hardware.

### Raw Interrupt Status (RIS)

Base 0x400F.E000

Offset 0x050

Type RO, reset 0x0000.0000

	31	30	29	28	27	26	25	24	23	22	21	20	19	18	17	16	
	reserved																
Type	RO	RO	RO	RO	RO	RO	RO	RO	RO	RO	RO	RO	RO	RO	RO	RO	
Reset	0	0	0	0	0	0	0	0	0	0	0	0	0	0	0	0	
	15	14	13	12	11	10	9	8	7	6	5	4	3	2	1	0	
	reserved										PLLLRIS	reserved				BORRIS	reserved
Type	RO	RO	RO	RO	RO	RO	RO	RO	RO	RO	RO	RO	RO	RO	RO	RO	
Reset	0	0	0	0	0	0	0	0	0	0	0	0	0	0	0	0	

Bit/Field	Name	Type	Reset	Description
31:7	reserved	RO	0	Software should not rely on the value of a reserved bit. To provide compatibility with future products, the value of a reserved bit should be preserved across a read-modify-write operation.
6	PLLLRIS	RO	0	PLL Lock Raw Interrupt Status This bit is set when the PLL T <sub>READY</sub> Timer asserts.
5:2	reserved	RO	0	Software should not rely on the value of a reserved bit. To provide compatibility with future products, the value of a reserved bit should be preserved across a read-modify-write operation.
1	BORRIS	RO	0	Brown-Out Reset Raw Interrupt Status This bit is the raw interrupt status for any brown-out conditions. If set, a brown-out condition is currently active. This is an unregistered signal from the brown-out detection circuit. An interrupt is reported if the BORIM bit in the <b>IMC</b> register is set and the BORIOR bit in the <b>PBORCTL</b> register is cleared.
0	reserved	RO	0	Software should not rely on the value of a reserved bit. To provide compatibility with future products, the value of a reserved bit should be preserved across a read-modify-write operation.

## Register 5: Interrupt Mask Control (IMC), offset 0x054

Central location for system control interrupt masks.

### Interrupt Mask Control (IMC)

Base 0x400F.E000  
 Offset 0x054  
 Type R/W, reset 0x0000.0000

	31	30	29	28	27	26	25	24	23	22	21	20	19	18	17	16
	reserved															
Type	RO	RO	RO	RO	RO	RO	RO	RO	RO	RO	RO	RO	RO	RO	RO	RO
Reset	0	0	0	0	0	0	0	0	0	0	0	0	0	0	0	0
	15	14	13	12	11	10	9	8	7	6	5	4	3	2	1	0
	reserved										PLLIM	reserved			BORIM	reserved
Type	RO	RO	RO	RO	RO	RO	RO	RO	RO	RO	R/W	RO	RO	RO	RO	RO
Reset	0	0	0	0	0	0	0	0	0	0	0	0	0	0	0	0

Bit/Field	Name	Type	Reset	Description
31:7	reserved	RO	0	Software should not rely on the value of a reserved bit. To provide compatibility with future products, the value of a reserved bit should be preserved across a read-modify-write operation.
6	PLLIM	R/W	0	PLL Lock Interrupt Mask  This bit specifies whether a current limit detection is promoted to a controller interrupt. If set, an interrupt is generated if <code>PLLRRIS</code> in <b>RIS</b> is set; otherwise, an interrupt is not generated.
5:2	reserved	RO	0	Software should not rely on the value of a reserved bit. To provide compatibility with future products, the value of a reserved bit should be preserved across a read-modify-write operation.
1	BORIM	R/W	0	Brown-Out Reset Interrupt Mask  This bit specifies whether a brown-out condition is promoted to a controller interrupt. If set, an interrupt is generated if <code>BORRIS</code> is set; otherwise, an interrupt is not generated.
0	reserved	RO	0	Software should not rely on the value of a reserved bit. To provide compatibility with future products, the value of a reserved bit should be preserved across a read-modify-write operation.

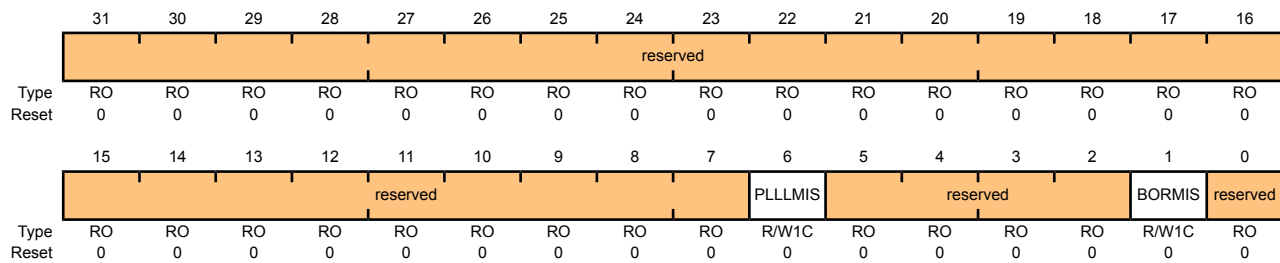
### Register 6: Masked Interrupt Status and Clear (MISC), offset 0x058

Central location for system control result of RIS AND IMC to generate an interrupt to the controller. All of the bits are R/W1C and this action also clears the corresponding raw interrupt bit in the **RIS** register (see page 67).

SHRM says: It is more than the contents of the RIS register ANDed with the the contents of the IMC register. This register latches a positive AND result and holds it until cleared by software. A straight combinatoric AND is insufficient. CR: What do we want to say in para?

#### Masked Interrupt Status and Clear (MISC)

Base 0x400F.E000  
 Offset 0x058  
 Type R/W1C, reset 0x0000.0000



Bit/Field	Name	Type	Reset	Description
31:7	reserved	RO	0	Software should not rely on the value of a reserved bit. To provide compatibility with future products, the value of a reserved bit should be preserved across a read-modify-write operation.
6	PLLLMIS	R/W1C	0	PLL Lock Masked Interrupt Status  This bit is set when the PLL T <sub>READY</sub> timer asserts. The interrupt is cleared by writing a 1 to this bit.
5:2	reserved	RO	0	Software should not rely on the value of a reserved bit. To provide compatibility with future products, the value of a reserved bit should be preserved across a read-modify-write operation.
1	BORMIS	R/W1C	0	BOR Masked Interrupt Status  The BORMIS is simply the BORRIS ANDed with the mask value, BORIM.
0	reserved	RO	0	Software should not rely on the value of a reserved bit. To provide compatibility with future products, the value of a reserved bit should be preserved across a read-modify-write operation.

## Register 7: Reset Cause (RESC), offset 0x05C

This register is set with the reset cause after reset. The bits in this register are sticky and maintain their state across multiple reset sequences, except when an external reset is the cause, and then all the other bits in the **RESC** register are cleared.

### Reset Cause (RESC)

Base 0x400F.E000

Offset 0x05C

Type R/W, reset -

	31	30	29	28	27	26	25	24	23	22	21	20	19	18	17	16	
	reserved																
Type	RO	RO	RO	RO	RO	RO	RO	RO	RO	RO	RO	RO	RO	RO	RO	RO	
Reset	0	0	0	0	0	0	0	0	0	0	0	0	0	0	0	0	
	15	14	13	12	11	10	9	8	7	6	5	4	3	2	1	0	
	reserved											LDO	SW	WDT	BOR	POR	EXT
Type	RO	RO	RO	RO	RO	RO	RO	RO	RO	RO	R/W	R/W	R/W	R/W	R/W	R/W	
Reset	0	0	0	0	0	0	0	0	0	0	-	-	-	-	-	-	

Bit/Field	Name	Type	Reset	Description
31:6	reserved	RO	0	Software should not rely on the value of a reserved bit. To provide compatibility with future products, the value of a reserved bit should be preserved across a read-modify-write operation.
5	LDO	R/W	-	LDO Reset  When set, indicates the LDO circuit has lost regulation and has generated a reset event.
4	SW	R/W	-	Software Reset  When set, indicates a software reset is the cause of the reset event.
3	WDT	R/W	-	Watchdog Timer Reset  When set, indicates a watchdog reset is the cause of the reset event.
2	BOR	R/W	-	Brown-Out Reset  When set, indicates a brown-out reset is the cause of the reset event.
1	POR	R/W	-	Power-On Reset  When set, indicates a power-on reset is the cause of the reset event.
0	EXT	R/W	-	External Reset  When set, indicates an external reset ( $\overline{RST}$ assertion) is the cause of the reset event.

## Register 8: Run-Mode Clock Configuration (RCC), offset 0x060

This register is defined to provide source control and frequency speed.

### Run-Mode Clock Configuration (RCC)

Base 0x400F.E000

Offset 0x060

Type R/W, reset 0x07A0.3AD1

	31	30	29	28	27	26	25	24	23	22	21	20	19	18	17	16
	reserved				ACG	SYSDIV				USESYSDIV	reserved					
Type	RO	RO	RO	RO	R/W	R/W	R/W	R/W	R/W	R/W	RO	RO	RO	RO	RO	RO
Reset	0	0	0	0	0	1	1	1	1	0	0	0	0	0	0	0
	15	14	13	12	11	10	9	8	7	6	5	4	3	2	1	0
	reserved		PWRDN	reserved	BYPASS	reserved	XTAL				OSCSRC		reserved		IOSCDIS	MOSCDIS
Type	RO	RO	R/W	RO	R/W	RO	R/W	R/W	R/W	R/W	R/W	R/W	RO	RO	R/W	R/W
Reset	0	0	1	1	1	0	1	0	1	1	0	1	0	0	0	1

Bit/Field	Name	Type	Reset	Description
31:28	reserved	RO	0x0	Software should not rely on the value of a reserved bit. To provide compatibility with future products, the value of a reserved bit should be preserved across a read-modify-write operation.
27	ACG	R/W	0	Auto Clock Gating

This bit specifies whether the system uses the **Sleep-Mode Clock Gating Control (SCGCn)** registers and **Deep-Sleep-Mode Clock Gating Control (DCGCn)** registers if the controller enters a Sleep or Deep-Sleep mode (respectively). If set, the **SCGCn** or **DCGCn** registers are used to control the clocks distributed to the peripherals when the controller is in a sleep mode. Otherwise, the **Run-Mode Clock Gating Control (RCGCn)** registers are used when the controller enters a sleep mode.

The **RCGCn** registers are always used to control the clocks in Run mode.

This allows peripherals to consume less power when the controller is in a sleep mode and the peripheral is unused.

Bit/Field	Name	Type	Reset	Description																																																			
26:23	SYSDIV	R/W	0xF	<p>System Clock Divisor</p> <p>Specifies which divisor is used to generate the system clock from the PLL output.</p> <p>The PLL VCO frequency is 400 MHz.</p> <table border="1"> <thead> <tr> <th>Value</th> <th>Divisor (BYPASS=1)</th> <th>Frequency (BYPASS=0)</th> </tr> </thead> <tbody> <tr><td>0x0</td><td>reserved</td><td>reserved</td></tr> <tr><td>0x1</td><td>/2</td><td>reserved</td></tr> <tr><td>0x2</td><td>/3</td><td>reserved</td></tr> <tr><td>0x3</td><td>/4</td><td>50 MHz</td></tr> <tr><td>0x4</td><td>/5</td><td>40 MHz</td></tr> <tr><td>0x5</td><td>/6</td><td>33.33 MHz</td></tr> <tr><td>0x6</td><td>/7</td><td>28.57 MHz</td></tr> <tr><td>0x7</td><td>/8</td><td>25 MHz</td></tr> <tr><td>0x8</td><td>/9</td><td>22.22 MHz</td></tr> <tr><td>0x9</td><td>/10</td><td>20 MHz</td></tr> <tr><td>0xA</td><td>/11</td><td>18.18 MHz</td></tr> <tr><td>0xB</td><td>/12</td><td>16.67 MHz</td></tr> <tr><td>0xC</td><td>/13</td><td>15.38 MHz</td></tr> <tr><td>0xD</td><td>/14</td><td>14.29 MHz</td></tr> <tr><td>0xE</td><td>/15</td><td>13.33 MHz</td></tr> <tr><td>0xF</td><td>/16</td><td>12.5 MHz (default)</td></tr> </tbody> </table> <p>When reading the <b>Run-Mode Clock Configuration (RCC)</b> register (see page 71), the SYSDIV value is MINSYSDIV if a lower divider was requested and the PLL is being used. This lower value is allowed to divide a non-PLL source.</p>	Value	Divisor (BYPASS=1)	Frequency (BYPASS=0)	0x0	reserved	reserved	0x1	/2	reserved	0x2	/3	reserved	0x3	/4	50 MHz	0x4	/5	40 MHz	0x5	/6	33.33 MHz	0x6	/7	28.57 MHz	0x7	/8	25 MHz	0x8	/9	22.22 MHz	0x9	/10	20 MHz	0xA	/11	18.18 MHz	0xB	/12	16.67 MHz	0xC	/13	15.38 MHz	0xD	/14	14.29 MHz	0xE	/15	13.33 MHz	0xF	/16	12.5 MHz (default)
Value	Divisor (BYPASS=1)	Frequency (BYPASS=0)																																																					
0x0	reserved	reserved																																																					
0x1	/2	reserved																																																					
0x2	/3	reserved																																																					
0x3	/4	50 MHz																																																					
0x4	/5	40 MHz																																																					
0x5	/6	33.33 MHz																																																					
0x6	/7	28.57 MHz																																																					
0x7	/8	25 MHz																																																					
0x8	/9	22.22 MHz																																																					
0x9	/10	20 MHz																																																					
0xA	/11	18.18 MHz																																																					
0xB	/12	16.67 MHz																																																					
0xC	/13	15.38 MHz																																																					
0xD	/14	14.29 MHz																																																					
0xE	/15	13.33 MHz																																																					
0xF	/16	12.5 MHz (default)																																																					
22	USESYSCLK	R/W	0	<p>Enable System Clock Divider</p> <p>Use the system clock divider as the source for the system clock. The system clock divider is forced to be used when the PLL is selected as the source.</p>																																																			
21:14	reserved	RO	0	Software should not rely on the value of a reserved bit. To provide compatibility with future products, the value of a reserved bit should be preserved across a read-modify-write operation.																																																			
13	PWRDN	R/W	1	<p>PLL Power Down</p> <p>This bit connects to the PLL PWRDN input. The reset value of 1 powers down the PLL.</p>																																																			
12	reserved	RO	1	Software should not rely on the value of a reserved bit. To provide compatibility with future products, the value of a reserved bit should be preserved across a read-modify-write operation.																																																			



Bit/Field	Name	Type	Reset	Description																																																			
11	BYPASS	R/W	1	<p>PLL Bypass</p> <p>Chooses whether the system clock is derived from the PLL output or the OSC source. If set, the clock that drives the system is the OSC source. Otherwise, the clock that drives the system is the PLL output clock divided by the system divider.</p> <p><b>Note:</b> The ADC must be clocked from the PLL or directly from a 14-MHz to 18-MHz clock source to operate properly. While the ADC works in a 14-18 MHz range, to maintain a 1 M sample/second rate, the ADC must be provided a 16-MHz clock source.</p>																																																			
10	reserved	RO	0	Software should not rely on the value of a reserved bit. To provide compatibility with future products, the value of a reserved bit should be preserved across a read-modify-write operation.																																																			
9:6	XTAL	R/W	0xB	<p>Crystal Value</p> <p>This field specifies the crystal value attached to the main oscillator. The encoding for this field is provided below.</p> <table border="1"> <thead> <tr> <th>Value</th> <th>Crystal Frequency (MHz) Not Using the PLL</th> <th>Crystal Frequency (MHz) Using the PLL</th> </tr> </thead> <tbody> <tr><td>0x0</td><td>1.000</td><td>reserved</td></tr> <tr><td>0x1</td><td>1.8432</td><td>reserved</td></tr> <tr><td>0x2</td><td>2.000</td><td>reserved</td></tr> <tr><td>0x3</td><td>2.4576</td><td>reserved</td></tr> <tr><td>0x4</td><td></td><td>3.579545 MHz</td></tr> <tr><td>0x5</td><td></td><td>3.6864 MHz</td></tr> <tr><td>0x6</td><td></td><td>4 MHz</td></tr> <tr><td>0x7</td><td></td><td>4.096 MHz</td></tr> <tr><td>0x8</td><td></td><td>4.9152 MHz</td></tr> <tr><td>0x9</td><td></td><td>5 MHz</td></tr> <tr><td>0xA</td><td></td><td>5.12 MHz</td></tr> <tr><td>0xB</td><td></td><td>6 MHz (reset value)</td></tr> <tr><td>0xC</td><td></td><td>6.144 MHz</td></tr> <tr><td>0xD</td><td></td><td>7.3728 MHz</td></tr> <tr><td>0xE</td><td></td><td>8 MHz</td></tr> <tr><td>0xF</td><td></td><td>8.192 MHz</td></tr> </tbody> </table>	Value	Crystal Frequency (MHz) Not Using the PLL	Crystal Frequency (MHz) Using the PLL	0x0	1.000	reserved	0x1	1.8432	reserved	0x2	2.000	reserved	0x3	2.4576	reserved	0x4		3.579545 MHz	0x5		3.6864 MHz	0x6		4 MHz	0x7		4.096 MHz	0x8		4.9152 MHz	0x9		5 MHz	0xA		5.12 MHz	0xB		6 MHz (reset value)	0xC		6.144 MHz	0xD		7.3728 MHz	0xE		8 MHz	0xF		8.192 MHz
Value	Crystal Frequency (MHz) Not Using the PLL	Crystal Frequency (MHz) Using the PLL																																																					
0x0	1.000	reserved																																																					
0x1	1.8432	reserved																																																					
0x2	2.000	reserved																																																					
0x3	2.4576	reserved																																																					
0x4		3.579545 MHz																																																					
0x5		3.6864 MHz																																																					
0x6		4 MHz																																																					
0x7		4.096 MHz																																																					
0x8		4.9152 MHz																																																					
0x9		5 MHz																																																					
0xA		5.12 MHz																																																					
0xB		6 MHz (reset value)																																																					
0xC		6.144 MHz																																																					
0xD		7.3728 MHz																																																					
0xE		8 MHz																																																					
0xF		8.192 MHz																																																					
5:4	OSCSRC	R/W	0x1	<p>Oscillator Source</p> <p>Picks among the four input sources for the OSC. The values are:</p> <table border="1"> <thead> <tr> <th>Value</th> <th>Input Source</th> </tr> </thead> <tbody> <tr><td>0x0</td><td>Main oscillator (default)</td></tr> <tr><td>0x1</td><td>Internal oscillator (default)</td></tr> <tr><td>0x2</td><td>Internal oscillator / 4 (this is necessary if used as input to PLL)</td></tr> <tr><td>0x3</td><td>reserved</td></tr> </tbody> </table>	Value	Input Source	0x0	Main oscillator (default)	0x1	Internal oscillator (default)	0x2	Internal oscillator / 4 (this is necessary if used as input to PLL)	0x3	reserved																																									
Value	Input Source																																																						
0x0	Main oscillator (default)																																																						
0x1	Internal oscillator (default)																																																						
0x2	Internal oscillator / 4 (this is necessary if used as input to PLL)																																																						
0x3	reserved																																																						

Bit/Field	Name	Type	Reset	Description
3:2	reserved	RO	0x0	Software should not rely on the value of a reserved bit. To provide compatibility with future products, the value of a reserved bit should be preserved across a read-modify-write operation.
1	IOSCDIS	R/W	0	Internal Oscillator Disable 0: Internal oscillator (IOSC) is enabled. 1: Internal oscillator is disabled.
0	MOSCDIS	R/W	1	Main Oscillator Disable 0: Main oscillator is enabled. 1: Main oscillator is disabled (default).

### Register 9: XTAL to PLL Translation (PLLCFG), offset 0x064

This register provides a means of translating external crystal frequencies into the appropriate PLL settings. This register is initialized during the reset sequence and updated anytime that the XTAL field changes in the Run-Mode Clock Configuration (RCC) register (see page 71).

The PLL frequency is calculated using the PLLCFG field values, as follows:

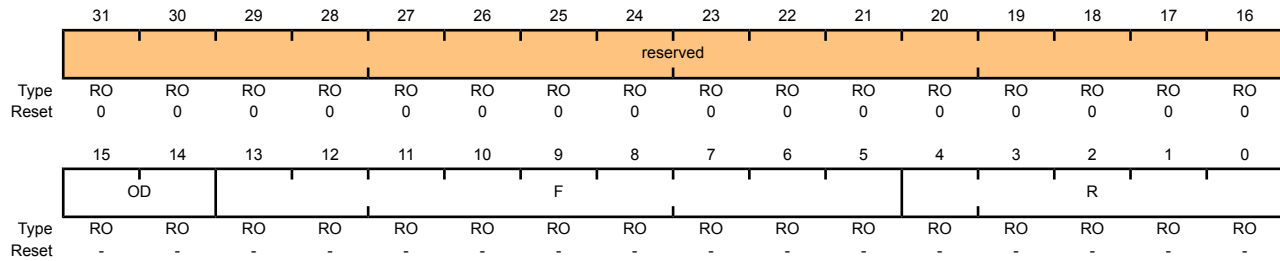
$$PLLFreq = OSCFreq * F / (R + 1)$$

#### XTAL to PLL Translation (PLLCFG)

Base 0x400F.E000

Offset 0x064

Type RO, reset -



Bit/Field	Name	Type	Reset	Description
31:16	reserved	RO	0x0	Software should not rely on the value of a reserved bit. To provide compatibility with future products, the value of a reserved bit should be preserved across a read-modify-write operation.
15:14	OD	RO	-	PLL OD Value This field specifies the value supplied to the PLL's OD input.  Value Description 0x0 Divide by 1 0x1 Divide by 2 0x2 Divide by 4 0x3 Reserved
13:5	F	RO	-	PLL F Value This field specifies the value supplied to the PLL's F input.
4:0	R	RO	-	PLL R Value This field specifies the value supplied to the PLL's R input.

### Register 10: Run-Mode Clock Configuration 2 (RCC2), offset 0x070

This register overrides the **RCC** equivalent register fields when the `USERCC2` bit is set. This allows **RCC2** to be used to extend the capabilities, while also providing a means to be backward-compatible to previous parts. The fields within the **RCC2** register occupy the same bit positions as they do within the **RCC** register as LSB-justified.

The `SYSDIV2` field is wider so that additional larger divisors are possible. This allows a lower system clock frequency for improved Deep Sleep power consumption.

#### Run-Mode Clock Configuration 2 (RCC2)

Base 0x400F.E000  
 Offset 0x070  
 Type R/W, reset 0x0780.2800

	31	30	29	28	27	26	25	24	23	22	21	20	19	18	17	16
	USERCC2	reserved			SYSDIV2						reserved					
Type	R/W	RO	RO	R/W	R/W	R/W	R/W	R/W	R/W	RO	RO	RO	RO	RO	RO	RO
Reset	0	0	0	0	0	1	1	1	1	0	0	0	0	0	0	0
	15	14	13	12	11	10	9	8	7	6	5	4	3	2	1	0
	reserved		PWRDN2	reserved	BYPASS2	reserved				OSCSRC2			reserved			
Type	RO	RO	R/W	RO	R/W	RO	RO	RO	RO	R/W	R/W	R/W	RO	RO	RO	RO
Reset	0	0	1	0	1	0	0	0	0	0	0	0	0	0	0	0

Bit/Field	Name	Type	Reset	Description
31	USERCC2	R/W	0	Use RCC2 When set, overrides the <b>RCC</b> register fields.
30:29	reserved	RO	0x0	Software should not rely on the value of a reserved bit. To provide compatibility with future products, the value of a reserved bit should be preserved across a read-modify-write operation.
28:23	SYSDIV2	R/W	0x0F	System Clock Divisor Specifies which divisor is used to generate the system clock from the PLL output. The PLL VCO frequency is 400 MHz. This field is wider than the <b>RCC</b> register <code>SYSDIV</code> field in order to provide additional divisor values. This permits the system clock to be run at much lower frequencies during Deep Sleep mode. For example, where the <b>RCC</b> register <code>SYSDIV</code> encoding of 111 provides /16, the <b>RCC2</b> register <code>SYSDIV2</code> encoding of 111111 provides /64.
22:14	reserved	RO	0x0	Software should not rely on the value of a reserved bit. To provide compatibility with future products, the value of a reserved bit should be preserved across a read-modify-write operation.
13	PWRDN2	R/W	1	Power-Down PLL When set, powers down the PLL.
12	reserved	RO	0	Software should not rely on the value of a reserved bit. To provide compatibility with future products, the value of a reserved bit should be preserved across a read-modify-write operation.
11	BYPASS2	R/W	1	Bypass PLL When set, bypasses the PLL for the clock source.

Bit/Field	Name	Type	Reset	Description												
10:7	reserved	RO	0x0	Software should not rely on the value of a reserved bit. To provide compatibility with future products, the value of a reserved bit should be preserved across a read-modify-write operation.												
6:4	OSCSRC2	R/W	0x0	System Clock Source  <table border="1"> <thead> <tr> <th>Value</th> <th>Description</th> </tr> </thead> <tbody> <tr> <td>0x0</td> <td>Main oscillator (MOSC)</td> </tr> <tr> <td>0x1</td> <td>Internal oscillator (IOSC)</td> </tr> <tr> <td>0x2</td> <td>Internal oscillator / 4</td> </tr> <tr> <td>0x3</td> <td>30 kHz internal oscillator</td> </tr> <tr> <td>0x7</td> <td>32 kHz external oscillator</td> </tr> </tbody> </table>	Value	Description	0x0	Main oscillator (MOSC)	0x1	Internal oscillator (IOSC)	0x2	Internal oscillator / 4	0x3	30 kHz internal oscillator	0x7	32 kHz external oscillator
Value	Description															
0x0	Main oscillator (MOSC)															
0x1	Internal oscillator (IOSC)															
0x2	Internal oscillator / 4															
0x3	30 kHz internal oscillator															
0x7	32 kHz external oscillator															
3:0	reserved	RO	0	Software should not rely on the value of a reserved bit. To provide compatibility with future products, the value of a reserved bit should be preserved across a read-modify-write operation.												

## Register 11: Deep Sleep Clock Configuration (DSLPCCLKCFG), offset 0x144

This register provides configuration information for the hardware control of Deep Sleep Mode.

### Deep Sleep Clock Configuration (DSLPCCLKCFG)

Base 0x400F.E000  
 Offset 0x144  
 Type R/W, reset 0x0780.0000

	31	30	29	28	27	26	25	24	23	22	21	20	19	18	17	16
	reserved			DSDIVORIDE						reserved						
Type	RO	RO	RO	R/W	R/W	R/W	R/W	R/W	R/W	RO	RO	RO	RO	RO	RO	RO
Reset	0	0	0	0	0	1	1	1	1	0	0	0	0	0	0	0
	15	14	13	12	11	10	9	8	7	6	5	4	3	2	1	0
	reserved									DSOSCSRC			reserved			
Type	RO	RO	RO	RO	RO	RO	RO	RO	RO	R/W	R/W	R/W	RO	RO	RO	RO
Reset	0	0	0	0	0	0	0	0	0	0	0	0	0	0	0	0

Bit/Field	Name	Type	Reset	Description															
31:29	reserved	RO	0x0	Software should not rely on the value of a reserved bit. To provide compatibility with future products, the value of a reserved bit should be preserved across a read-modify-write operation.															
28:23	DSDIVORIDE	R/W	0x0F	Divider Field Override 6-bit system divider field to override when Deep-Sleep occurs with PLL running.															
22:7	reserved	RO	0x0	Software should not rely on the value of a reserved bit. To provide compatibility with future products, the value of a reserved bit should be preserved across a read-modify-write operation.															
6:4	DSOSCSRC	R/W	0x0	Clock Source When set, forces IOSC to be clock source during Deep Sleep mode.  <table border="1"> <thead> <tr> <th>Value</th> <th>Name</th> <th>Description</th> </tr> </thead> <tbody> <tr> <td>0x0</td> <td>NOORIDE</td> <td>No override to the oscillator clock source is done</td> </tr> <tr> <td>0x1</td> <td>IOSC</td> <td>Use internal 12 MHz oscillator as source</td> </tr> <tr> <td>0x3</td> <td>30kHz</td> <td>Use 30 kHz internal oscillator</td> </tr> <tr> <td>0x7</td> <td>32kHz</td> <td>Use 32 kHz external oscillator</td> </tr> </tbody> </table>	Value	Name	Description	0x0	NOORIDE	No override to the oscillator clock source is done	0x1	IOSC	Use internal 12 MHz oscillator as source	0x3	30kHz	Use 30 kHz internal oscillator	0x7	32kHz	Use 32 kHz external oscillator
Value	Name	Description																	
0x0	NOORIDE	No override to the oscillator clock source is done																	
0x1	IOSC	Use internal 12 MHz oscillator as source																	
0x3	30kHz	Use 30 kHz internal oscillator																	
0x7	32kHz	Use 32 kHz external oscillator																	
3:0	reserved	RO	0x0	Software should not rely on the value of a reserved bit. To provide compatibility with future products, the value of a reserved bit should be preserved across a read-modify-write operation.															

## Register 12: Device Identification 1 (DID1), offset 0x004

This register identifies the device family, part number, temperature range, pin count, and package type.

### Device Identification 1 (DID1)

Base 0x400F.E000

Offset 0x004

Type RO, reset -

	31	30	29	28	27	26	25	24	23	22	21	20	19	18	17	16
	VER				FAM				PARTNO							
Type	RO	RO	RO	RO	RO	RO	RO	RO	RO	RO	RO	RO	RO	RO	RO	RO
Reset	0	0	0	1	0	0	0	0	1	1	0	0	0	1	0	1
	15	14	13	12	11	10	9	8	7	6	5	4	3	2	1	0
	PINCOUNT			reserved				TEMP			PKG		ROHS	QUAL		
Type	RO	RO	RO	RO	RO	RO	RO	RO	RO	RO	RO	RO	RO	RO	RO	RO
Reset	0	1	0	0	0	0	0	0	0	0	1	0	1	1	-	-

Bit/Field	Name	Type	Reset	Description				
31:28	VER	RO	0x1	<p>DID1 Version</p> <p>This field defines the <b>DID1</b> register format version. The version number is numeric. The value of the <code>VER</code> field is encoded as follows (all other encodings are reserved):</p> <table border="1"> <thead> <tr> <th>Value</th> <th>Description</th> </tr> </thead> <tbody> <tr> <td>0x1</td> <td>First revision of the <b>DID1</b> register format, indicating a Stellaris Fury-class device.</td> </tr> </tbody> </table>	Value	Description	0x1	First revision of the <b>DID1</b> register format, indicating a Stellaris Fury-class device.
Value	Description							
0x1	First revision of the <b>DID1</b> register format, indicating a Stellaris Fury-class device.							
27:24	FAM	RO	0x0	<p>Family</p> <p>This field provides the family identification of the device within the Luminary Micro product portfolio. The value is encoded as follows (all other encodings are reserved):</p> <table border="1"> <thead> <tr> <th>Value</th> <th>Description</th> </tr> </thead> <tbody> <tr> <td>0x0</td> <td>Stellaris family of microcontrollers, that is, all devices with external part numbers starting with LM3S.</td> </tr> </tbody> </table>	Value	Description	0x0	Stellaris family of microcontrollers, that is, all devices with external part numbers starting with LM3S.
Value	Description							
0x0	Stellaris family of microcontrollers, that is, all devices with external part numbers starting with LM3S.							
23:16	PARTNO	RO	0xC5	<p>Part Number</p> <p>This field provides the part number of the device within the family. The value is encoded as follows (all other encodings are reserved):</p> <table border="1"> <thead> <tr> <th>Value</th> <th>Description</th> </tr> </thead> <tbody> <tr> <td>0xC5</td> <td>LM3S1138</td> </tr> </tbody> </table>	Value	Description	0xC5	LM3S1138
Value	Description							
0xC5	LM3S1138							
15:13	PINCOUNT	RO	0x2	<p>Package Pin Count</p> <p>This field specifies the number of pins on the device package. The value is encoded as follows (all other encodings are reserved):</p> <table border="1"> <thead> <tr> <th>Value</th> <th>Description</th> </tr> </thead> <tbody> <tr> <td>0x2</td> <td>100-pin package</td> </tr> </tbody> </table>	Value	Description	0x2	100-pin package
Value	Description							
0x2	100-pin package							

Bit/Field	Name	Type	Reset	Description
12:8	reserved	RO	0	Software should not rely on the value of a reserved bit. To provide compatibility with future products, the value of a reserved bit should be preserved across a read-modify-write operation.
7:5	TEMP	RO	0x1	Temperature Range  This field specifies the temperature rating of the device. The value is encoded as follows (all other encodings are reserved):  Value Description 0x1 Industrial temperature range (-40°C to 85°C)
4:3	PKG	RO	0x1	Package Type  This field specifies the package type. The value is encoded as follows (all other encodings are reserved):  Value Description 0x1 LQFP package
2	ROHS	RO	1	RoHS-Compliance  This bit specifies whether the device is RoHS-compliant. A 1 indicates the part is RoHS-compliant.
1:0	QUAL	RO	-	Qualification Status  This field specifies the qualification status of the device. The value is encoded as follows (all other encodings are reserved):  Value Description 0x0 Engineering Sample (unqualified) 0x1 Pilot Production (unqualified) 0x2 Fully Qualified



## Register 13: Device Capabilities 0 (DC0), offset 0x008

This register is predefined by the part and can be used to verify features.

### Device Capabilities 0 (DC0)

Base 0x400F.E000

Offset 0x008

Type RO, reset 0x003F.001F

	31	30	29	28	27	26	25	24	23	22	21	20	19	18	17	16
	SRAMSZ															
Type	RO	RO	RO	RO	RO	RO	RO	RO	RO	RO	RO	RO	RO	RO	RO	RO
Reset	0	0	0	0	0	0	0	0	0	0	1	1	1	1	1	1
	15	14	13	12	11	10	9	8	7	6	5	4	3	2	1	0
	FLASHSZ															
Type	RO	RO	RO	RO	RO	RO	RO	RO	RO	RO	RO	RO	RO	RO	RO	RO
Reset	0	0	0	0	0	0	0	0	0	0	0	1	1	1	1	1

Bit/Field	Name	Type	Reset	Description
31:16	SRAMSZ	RO	0x003F	SRAM Size Indicates the size of the on-chip SRAM memory.  Value    Description 0x003F  16 KB of SRAM
15:0	FLASHSZ	RO	0x001F	Flash Size Indicates the size of the on-chip flash memory.  Value    Description 0x001F  64 KB of Flash

### Register 14: Device Capabilities 1 (DC1), offset 0x010

This register provides a list of features available in the system. The Stellaris family uses this register format to indicate the availability of the following family features in the specific device: CANs, PWM, ADC, Watchdog timer, Hibernation module, and debug capabilities. This register also indicates the maximum clock frequency and maximum ADC sample rate. The format of this register is consistent with the **RCGC0**, **SCGC0**, and **DCGC0** clock control registers and the **SRCR0** software reset control register.

#### Device Capabilities 1 (DC1)

Base 0x400F.E000  
 Offset 0x010  
 Type RO, reset 0x0001.33FF

	31	30	29	28	27	26	25	24	23	22	21	20	19	18	17	16
	reserved															ADC
Type	RO	RO	RO	RO	RO	RO	RO	RO	RO	RO	RO	RO	RO	RO	RO	RO
Reset	0	0	0	0	0	0	0	0	0	0	0	0	0	0	0	1
	15	14	13	12	11	10	9	8	7	6	5	4	3	2	1	0
	MINSYSDIV				MAXADCSPD				MPU	HIB	TEMPSNS	PLL	WDT	SWO	SWD	JTAG
Type	RO	RO	RO	RO	RO	RO	RO	RO	RO	RO	RO	RO	RO	RO	RO	RO
Reset	0	0	1	1	0	0	1	1	1	1	1	1	1	1	1	1

Bit/Field	Name	Type	Reset	Description
31:17	reserved	RO	0	Software should not rely on the value of a reserved bit. To provide compatibility with future products, the value of a reserved bit should be preserved across a read-modify-write operation.
16	ADC	RO	1	ADC Module Present When set, indicates that the ADC module is present.
15:12	MINSYSDIV	RO	0x3	System Clock Divider Minimum 4-bit divider value for system clock. The reset value is hardware-dependent. See the <b>RCC</b> register for how to change the system clock divisor using the <i>SYSDIV</i> bit.  Value Description 0x3 Specifies a 50-MHz CPU clock with a PLL divider of 4.
11:8	MAXADCSPD	RO	0x3	Max ADC Speed Indicates the maximum rate at which the ADC samples data.  Value Description 0x3 1M samples/second
7	MPU	RO	1	MPU Present When set, indicates that the Cortex-M3 Memory Protection Unit (MPU) module is present. See the ARM Cortex-M3 Technical Reference Manual for details on the MPU.
6	HIB	RO	1	Hibernation Module Present When set, indicates that the Hibernation module is present.

---

Bit/Field	Name	Type	Reset	Description
5	TEMPSNS	RO	1	Temp Sensor Present When set, indicates that the on-chip temperature sensor is present.
4	PLL	RO	1	PLL Present When set, indicates that the on-chip Phase Locked Loop (PLL) is present.
3	WDT	RO	1	Watchdog Timer Present When set, indicates that a watchdog timer is present.
2	SWO	RO	1	SWO Trace Port Present When set, indicates that the Serial Wire Output (SWO) trace port is present.
1	SWD	RO	1	SWD Present When set, indicates that the Serial Wire Debugger (SWD) is present.
0	JTAG	RO	1	JTAG Present When set, indicates that the JTAG debugger interface is present.

## Register 15: Device Capabilities 2 (DC2), offset 0x014

This register provides a list of features available in the system. The Stellaris family uses this register format to indicate the availability of the following family features in the specific device: Analog Comparators, General-Purpose Timers, I2Cs, QEIs, SSIs, and UARTs. The format of this register is consistent with the **RCGC1**, **SCGC1**, and **DCGC1** clock control registers and the **SRCR1** software reset control register.

### Device Capabilities 2 (DC2)

Base 0x400F.E000

Offset 0x014

Type RO, reset 0x070F.5037

	31	30	29	28	27	26	25	24	23	22	21	20	19	18	17	16
	reserved					COMP2	COMP1	COMP0	reserved				TIMER3	TIMER2	TIMER1	TIMER0
Type	RO	RO	RO	RO	RO	RO	RO	RO	RO	RO	RO	RO	RO	RO	RO	RO
Reset	0	0	0	0	0	1	1	1	0	0	0	0	1	1	1	1
	15	14	13	12	11	10	9	8	7	6	5	4	3	2	1	0
	reserved	I2C1	reserved	I2C0	reserved						SSI1	SSI0	reserved	UART2	UART1	UART0
Type	RO	RO	RO	RO	RO	RO	RO	RO	RO	RO	RO	RO	RO	RO	RO	RO
Reset	0	1	0	1	0	0	0	0	0	0	0	1	1	0	1	1

Bit/Field	Name	Type	Reset	Description
31:27	reserved	RO	0	Software should not rely on the value of a reserved bit. To provide compatibility with future products, the value of a reserved bit should be preserved across a read-modify-write operation.
26	COMP2	RO	1	Analog Comparator 2 Present When set, indicates that analog comparator 2 is present.
25	COMP1	RO	1	Analog Comparator 1 Present When set, indicates that analog comparator 1 is present.
24	COMP0	RO	1	Analog Comparator 0 Present When set, indicates that analog comparator 0 is present.
23:20	reserved	RO	0	Software should not rely on the value of a reserved bit. To provide compatibility with future products, the value of a reserved bit should be preserved across a read-modify-write operation.
19	TIMER3	RO	1	Timer 3 Present When set, indicates that General-Purpose Timer module 3 is present.
18	TIMER2	RO	1	Timer 2 Present When set, indicates that General-Purpose Timer module 2 is present.
17	TIMER1	RO	1	Timer 1 Present When set, indicates that General-Purpose Timer module 1 is present.
16	TIMER0	RO	1	Timer 0 Present When set, indicates that General-Purpose Timer module 0 is present.
15	reserved	RO	0	Software should not rely on the value of a reserved bit. To provide compatibility with future products, the value of a reserved bit should be preserved across a read-modify-write operation.

Bit/Field	Name	Type	Reset	Description
14	I2C1	RO	1	I2C Module 1 Present When set, indicates that I2C module 1 is present.
13	reserved	RO	0	Software should not rely on the value of a reserved bit. To provide compatibility with future products, the value of a reserved bit should be preserved across a read-modify-write operation.
12	I2C0	RO	1	I2C Module 0 Present When set, indicates that I2C module 0 is present.
11:6	reserved	RO	0	Software should not rely on the value of a reserved bit. To provide compatibility with future products, the value of a reserved bit should be preserved across a read-modify-write operation.
5	SSI1	RO	1	SSI1 Present When set, indicates that SSI module 1 is present.
4	SSI0	RO	1	SSI0 Present When set, indicates that SSI module 0 is present.
3	reserved	RO	0	Software should not rely on the value of a reserved bit. To provide compatibility with future products, the value of a reserved bit should be preserved across a read-modify-write operation.
2	UART2	RO	1	UART2 Present When set, indicates that UART module 2 is present.
1	UART1	RO	1	UART1 Present When set, indicates that UART module 1 is present.
0	UART0	RO	1	UART0 Present When set, indicates that UART module 0 is present.

## Register 16: Device Capabilities 3 (DC3), offset 0x018

This register provides a list of features available in the system. The Stellaris family uses this register format to indicate the availability of the following family features in the specific device: Analog Comparator I/Os, CCP I/Os, ADC I/Os, and PWM I/Os.

### Device Capabilities 3 (DC3)

Base 0x400F.E000  
 Offset 0x018  
 Type RO, reset 0x3FFF.7FC0

	31	30	29	28	27	26	25	24	23	22	21	20	19	18	17	16
	reserved		CCP5	CCP4	CCP3	CCP2	CCP1	CCP0	ADC7	ADC6	ADC5	ADC4	ADC3	ADC2	ADC1	ADC0
Type	RO	RO	RO	RO	RO	RO	RO	RO	RO	RO	RO	RO	RO	RO	RO	RO
Reset	0	0	1	1	1	1	1	1	1	1	1	1	1	1	1	1
	15	14	13	12	11	10	9	8	7	6	5	4	3	2	1	0
	reserved	C2O	C2PLUS	C2MINUS	C1O	C1PLUS	C1MINUS	C0O	C0PLUS	C0MINUS	reserved					
Type	RO	RO	RO	RO	RO	RO	RO	RO	RO	RO	RO	RO	RO	RO	RO	RO
Reset	0	1	1	1	1	1	1	1	1	1	0	0	0	0	0	0

Bit/Field	Name	Type	Reset	Description
31:30	reserved	RO	0	Software should not rely on the value of a reserved bit. To provide compatibility with future products, the value of a reserved bit should be preserved across a read-modify-write operation.
29	CCP5	RO	1	CCP5 Pin Present When set, indicates that Capture/Compare/PWM pin 5 is present.
28	CCP4	RO	1	CCP4 Pin Present When set, indicates that Capture/Compare/PWM pin 4 is present.
27	CCP3	RO	1	CCP3 Pin Present When set, indicates that Capture/Compare/PWM pin 3 is present.
26	CCP2	RO	1	CCP2 Pin Present When set, indicates that Capture/Compare/PWM pin 2 is present.
25	CCP1	RO	1	CCP1 Pin Present When set, indicates that Capture/Compare/PWM pin 1 is present.
24	CCP0	RO	1	CCP0 Pin Present When set, indicates that Capture/Compare/PWM pin 0 is present.
23	ADC7	RO	1	ADC7 Pin Present When set, indicates that ADC pin 7 is present.
22	ADC6	RO	1	ADC6 Pin Present When set, indicates that ADC pin 6 is present.
21	ADC5	RO	1	ADC5 Pin Present When set, indicates that ADC pin 5 is present.

Bit/Field	Name	Type	Reset	Description
20	ADC4	RO	1	ADC4 Pin Present When set, indicates that ADC pin 4 is present.
19	ADC3	RO	1	ADC3 Pin Present When set, indicates that ADC pin 3 is present.
18	ADC2	RO	1	ADC2 Pin Present When set, indicates that ADC pin 2 is present.
17	ADC1	RO	1	ADC1 Pin Present When set, indicates that ADC pin 1 is present.
16	ADC0	RO	1	ADC0 Pin Present When set, indicates that ADC pin 0 is present.
15	reserved	RO	0	Software should not rely on the value of a reserved bit. To provide compatibility with future products, the value of a reserved bit should be preserved across a read-modify-write operation.
14	C2O	RO	1	C2o Pin Present When set, indicates that the analog comparator 2 output pin is present.
13	C2PLUS	RO	1	C2+ Pin Present When set, indicates that the analog comparator 2 (+) input pin is present.
12	C2MINUS	RO	1	C2- Pin Present When set, indicates that the analog comparator 2 (-) input pin is present.
11	C1O	RO	1	C1o Pin Present When set, indicates that the analog comparator 1 output pin is present.
10	C1PLUS	RO	1	C1+ Pin Present When set, indicates that the analog comparator 1 (+) input pin is present.
9	C1MINUS	RO	1	C1- Pin Present When set, indicates that the analog comparator 1 (-) input pin is present.
8	C0O	RO	1	C0o Pin Present When set, indicates that the analog comparator 0 output pin is present.
7	C0PLUS	RO	1	C0+ Pin Present When set, indicates that the analog comparator 0 (+) input pin is present.
6	C0MINUS	RO	1	C0- Pin Present When set, indicates that the analog comparator 0 (-) input pin is present.
5:0	reserved	RO	0	Software should not rely on the value of a reserved bit. To provide compatibility with future products, the value of a reserved bit should be preserved across a read-modify-write operation.

## Register 17: Device Capabilities 4 (DC4), offset 0x01C

This register provides a list of features available in the system. The Stellaris family uses this register format to indicate the availability of the following family features in the specific device: Ethernet MAC and PHY, GPIOs, and CCP I/Os. The format of this register is consistent with the **RCGC2**, **SCGC2**, and **DCGC2** clock control registers and the **SRCR2** software reset control register.

### Device Capabilities 4 (DC4)

Base 0x400F.E000  
 Offset 0x01C  
 Type RO, reset 0x0000.00FF

	31	30	29	28	27	26	25	24	23	22	21	20	19	18	17	16
	reserved															
Type	RO	RO	RO	RO	RO	RO	RO	RO	RO	RO	RO	RO	RO	RO	RO	RO
Reset	0	0	0	0	0	0	0	0	0	0	0	0	0	0	0	0
	15	14	13	12	11	10	9	8	7	6	5	4	3	2	1	0
	reserved								GPIOH	GPIOG	GPIOF	GPIOE	GPIOD	GPIOC	GPIOB	GPIOA
Type	RO	RO	RO	RO	RO	RO	RO	RO	RO	RO	RO	RO	RO	RO	RO	RO
Reset	0	0	0	0	0	0	0	0	1	1	1	1	1	1	1	1

Bit/Field	Name	Type	Reset	Description
31:8	reserved	RO	0	Software should not rely on the value of a reserved bit. To provide compatibility with future products, the value of a reserved bit should be preserved across a read-modify-write operation.
7	GPIOH	RO	1	GPIO Port H Present When set, indicates that GPIO Port H is present.
6	GPIOG	RO	1	GPIO Port G Present When set, indicates that GPIO Port G is present.
5	GPIOF	RO	1	GPIO Port F Present When set, indicates that GPIO Port F is present.
4	GPIOE	RO	1	GPIO Port E Present When set, indicates that GPIO Port E is present.
3	GPIOD	RO	1	GPIO Port D Present When set, indicates that GPIO Port D is present.
2	GPIOC	RO	1	GPIO Port C Present When set, indicates that GPIO Port C is present.
1	GPIOB	RO	1	GPIO Port B Present When set, indicates that GPIO Port B is present.
0	GPIOA	RO	1	GPIO Port A Present When set, indicates that GPIO Port A is present.



## Register 18: Run Mode Clock Gating Control Register 0 (RCGC0), offset 0x100

This register controls the clock gating logic. Each bit controls a clock enable for a given interface, function, or unit. If set, the unit receives a clock and functions. Otherwise, the unit is unclocked and disabled (saving power). If the unit is unclocked, reads or writes to the unit will generate a bus fault. The reset state of these bits is 0 (unclocked) unless otherwise noted, so that all functional units are disabled. It is the responsibility of software to enable the ports necessary for the application. Note that these registers may contain more bits than there are interfaces, functions, or units to control. This is to assure reasonable code compatibility with other family and future parts. **RCGC0** is the clock configuration register for running operation, **SCGC0** for Sleep operation, and **DCGC0** for Deep-Sleep operation. Setting the **ACG** bit in the **Run-Mode Clock Configuration (RCC)** register specifies that the system uses sleep modes.

### Run Mode Clock Gating Control Register 0 (RCGC0)

Base 0x400F.E000

Offset 0x100

Type R/W, reset 0x00000040

	31	30	29	28	27	26	25	24	23	22	21	20	19	18	17	16
	reserved															ADC
Type	RO	RO	RO	RO	RO	RO	RO	RO	RO	RO	RO	RO	RO	RO	RO	R/W
Reset	0	0	0	0	0	0	0	0	0	0	0	0	0	0	0	0
	15	14	13	12	11	10	9	8	7	6	5	4	3	2	1	0
	reserved				MAXADCSPD			reserved	HIB	reserved	WDT	reserved				
Type	RO	RO	RO	RO	R/W	R/W	R/W	R/W	RO	R/W	RO	RO	R/W	RO	RO	RO
Reset	0	0	0	0	0	0	0	0	0	0	0	0	0	0	0	0

Bit/Field	Name	Type	Reset	Description										
31:17	reserved	RO	0	Software should not rely on the value of a reserved bit. To provide compatibility with future products, the value of a reserved bit should be preserved across a read-modify-write operation.										
16	ADC	R/W	0	<p>ADC0 Clock Gating Control</p> <p>This bit controls the clock gating for SAR ADC module 0. If set, the unit receives a clock and functions. Otherwise, the unit is unclocked and disabled. If the unit is unclocked, a read or write to the unit generates a bus fault.</p>										
15:12	reserved	RO	0	Software should not rely on the value of a reserved bit. To provide compatibility with future products, the value of a reserved bit should be preserved across a read-modify-write operation.										
11:8	MAXADCSPD	R/W	0	<p>ADC Sample Speed</p> <p>This field sets the rate at which the ADC samples data. You cannot set the rate higher than the maximum rate. You can set the sample rate by setting the MAXADCSPD bit as follows:</p> <table border="1"> <thead> <tr> <th>Value</th> <th>Description</th> </tr> </thead> <tbody> <tr> <td>0x3</td> <td>1M samples/second</td> </tr> <tr> <td>0x2</td> <td>500K samples/second</td> </tr> <tr> <td>0x1</td> <td>250K samples/second</td> </tr> <tr> <td>0x0</td> <td>125K samples/second</td> </tr> </tbody> </table>	Value	Description	0x3	1M samples/second	0x2	500K samples/second	0x1	250K samples/second	0x0	125K samples/second
Value	Description													
0x3	1M samples/second													
0x2	500K samples/second													
0x1	250K samples/second													
0x0	125K samples/second													

Bit/Field	Name	Type	Reset	Description
7	reserved	RO	0	Software should not rely on the value of a reserved bit. To provide compatibility with future products, the value of a reserved bit should be preserved across a read-modify-write operation.
6	HIB	R/W	0	HIB Clock Gating Control  This bit controls the clock gating for the Hibernation module. If set, the unit receives a clock and functions. Otherwise, the unit is unlocked and disabled.
5:4	reserved	RO	0	Software should not rely on the value of a reserved bit. To provide compatibility with future products, the value of a reserved bit should be preserved across a read-modify-write operation.
3	WDT	R/W	0	WDT Clock Gating Control  This bit controls the clock gating for the WDT module. If set, the unit receives a clock and functions. Otherwise, the unit is unlocked and disabled. If the unit is unlocked, a read or write to the unit generates a bus fault.
2:0	reserved	RO	0	Software should not rely on the value of a reserved bit. To provide compatibility with future products, the value of a reserved bit should be preserved across a read-modify-write operation.

## Register 19: Sleep Mode Clock Gating Control Register 0 (SCGC0), offset 0x110

This register controls the clock gating logic. Each bit controls a clock enable for a given interface, function, or unit. If set, the unit receives a clock and functions. Otherwise, the unit is unlocked and disabled (saving power). If the unit is unlocked, reads or writes to the unit will generate a bus fault. The reset state of these bits is 0 (unlocked) unless otherwise noted, so that all functional units are disabled. It is the responsibility of software to enable the ports necessary for the application. Note that these registers may contain more bits than there are interfaces, functions, or units to control. This is to assure reasonable code compatibility with other family and future parts. **RCGC0** is the clock configuration register for running operation, **SCGC0** for Sleep operation, and **DCGC0** for Deep-Sleep operation. Setting the **ACG** bit in the **Run-Mode Clock Configuration (RCC)** register specifies that the system uses sleep modes.

### Sleep Mode Clock Gating Control Register 0 (SCGC0)

Base 0x400F.E000

Offset 0x110

Type R/W, reset 0x00000040

	31	30	29	28	27	26	25	24	23	22	21	20	19	18	17	16
	reserved															ADC
Type	RO	RO	RO	RO	RO	RO	RO	RO	RO	RO	RO	RO	RO	RO	RO	R/W
Reset	0	0	0	0	0	0	0	0	0	0	0	0	0	0	0	0
	15	14	13	12	11	10	9	8	7	6	5	4	3	2	1	0
	reserved				MAXADCSPD			reserved	HIB	reserved	WDT	reserved				
Type	RO	RO	RO	RO	R/W	R/W	R/W	R/W	RO	R/W	RO	RO	R/W	RO	RO	RO
Reset	0	0	0	0	0	0	0	0	0	0	0	0	0	0	0	0

Bit/Field	Name	Type	Reset	Description										
31:17	reserved	RO	0	Software should not rely on the value of a reserved bit. To provide compatibility with future products, the value of a reserved bit should be preserved across a read-modify-write operation.										
16	ADC	R/W	0	<p>ADC0 Clock Gating Control</p> <p>This bit controls the clock gating for SAR ADC module 0. If set, the unit receives a clock and functions. Otherwise, the unit is unlocked and disabled. If the unit is unlocked, a read or write to the unit generates a bus fault.</p>										
15:12	reserved	RO	0	Software should not rely on the value of a reserved bit. To provide compatibility with future products, the value of a reserved bit should be preserved across a read-modify-write operation.										
11:8	MAXADCSPD	R/W	0	<p>ADC Sample Speed</p> <p>This field sets the rate at which the ADC samples data. You cannot set the rate higher than the maximum rate. You can set the sample rate by setting the <b>MAXADCSPD</b> bit as follows:</p> <table border="1"> <thead> <tr> <th>Value</th> <th>Description</th> </tr> </thead> <tbody> <tr> <td>0x3</td> <td>1M samples/second</td> </tr> <tr> <td>0x2</td> <td>500K samples/second</td> </tr> <tr> <td>0x1</td> <td>250K samples/second</td> </tr> <tr> <td>0x0</td> <td>125K samples/second</td> </tr> </tbody> </table>	Value	Description	0x3	1M samples/second	0x2	500K samples/second	0x1	250K samples/second	0x0	125K samples/second
Value	Description													
0x3	1M samples/second													
0x2	500K samples/second													
0x1	250K samples/second													
0x0	125K samples/second													

Bit/Field	Name	Type	Reset	Description
7	reserved	RO	0	Software should not rely on the value of a reserved bit. To provide compatibility with future products, the value of a reserved bit should be preserved across a read-modify-write operation.
6	HIB	R/W	0	HIB Clock Gating Control  This bit controls the clock gating for the Hibernation module. If set, the unit receives a clock and functions. Otherwise, the unit is unlocked and disabled.
5:4	reserved	RO	0	Software should not rely on the value of a reserved bit. To provide compatibility with future products, the value of a reserved bit should be preserved across a read-modify-write operation.
3	WDT	R/W	0	WDT Clock Gating Control  This bit controls the clock gating for the WDT module. If set, the unit receives a clock and functions. Otherwise, the unit is unlocked and disabled. If the unit is unlocked, a read or write to the unit generates a bus fault.
2:0	reserved	RO	0	Software should not rely on the value of a reserved bit. To provide compatibility with future products, the value of a reserved bit should be preserved across a read-modify-write operation.

## Register 20: Deep Sleep Mode Clock Gating Control Register 0 (DCGC0), offset 0x120

This register controls the clock gating logic. Each bit controls a clock enable for a given interface, function, or unit. If set, the unit receives a clock and functions. Otherwise, the unit is unlocked and disabled (saving power). If the unit is unlocked, reads or writes to the unit will generate a bus fault. The reset state of these bits is 0 (unlocked) unless otherwise noted, so that all functional units are disabled. It is the responsibility of software to enable the ports necessary for the application. Note that these registers may contain more bits than there are interfaces, functions, or units to control. This is to assure reasonable code compatibility with other family and future parts. **RCGC0** is the clock configuration register for running operation, **SCGC0** for Sleep operation, and **DCGC0** for Deep-Sleep operation. Setting the **ACG** bit in the **Run-Mode Clock Configuration (RCC)** register specifies that the system uses sleep modes.

### Deep Sleep Mode Clock Gating Control Register 0 (DCGC0)

Base 0x400F.E000

Offset 0x120

Type R/W, reset 0x00000040

	31	30	29	28	27	26	25	24	23	22	21	20	19	18	17	16
	reserved															ADC
Type	RO	RO	RO	RO	RO	RO	RO	RO	RO	RO	RO	RO	RO	RO	RO	R/W
Reset	0	0	0	0	0	0	0	0	0	0	0	0	0	0	0	0
	15	14	13	12	11	10	9	8	7	6	5	4	3	2	1	0
	reserved				MAXADCSPD			reserved	HIB	reserved	WDT		reserved			
Type	RO	RO	RO	RO	R/W	R/W	R/W	R/W	RO	R/W	RO	RO	R/W	RO	RO	RO
Reset	0	0	0	0	0	0	0	0	0	0	0	0	0	0	0	0

Bit/Field	Name	Type	Reset	Description										
31:17	reserved	RO	0	Software should not rely on the value of a reserved bit. To provide compatibility with future products, the value of a reserved bit should be preserved across a read-modify-write operation.										
16	ADC	R/W	0	<p>ADC0 Clock Gating Control</p> <p>This bit controls the clock gating for SAR ADC module 0. If set, the unit receives a clock and functions. Otherwise, the unit is unlocked and disabled. If the unit is unlocked, a read or write to the unit generates a bus fault.</p>										
15:12	reserved	RO	0	Software should not rely on the value of a reserved bit. To provide compatibility with future products, the value of a reserved bit should be preserved across a read-modify-write operation.										
11:8	MAXADCSPD	R/W	0	<p>ADC Sample Speed</p> <p>This field sets the rate at which the ADC samples data. You cannot set the rate higher than the maximum rate. You can set the sample rate by setting the <code>MAXADCSPD</code> bit as follows:</p> <table border="1"> <thead> <tr> <th>Value</th> <th>Description</th> </tr> </thead> <tbody> <tr> <td>0x3</td> <td>1M samples/second</td> </tr> <tr> <td>0x2</td> <td>500K samples/second</td> </tr> <tr> <td>0x1</td> <td>250K samples/second</td> </tr> <tr> <td>0x0</td> <td>125K samples/second</td> </tr> </tbody> </table>	Value	Description	0x3	1M samples/second	0x2	500K samples/second	0x1	250K samples/second	0x0	125K samples/second
Value	Description													
0x3	1M samples/second													
0x2	500K samples/second													
0x1	250K samples/second													
0x0	125K samples/second													

Bit/Field	Name	Type	Reset	Description
7	reserved	RO	0	Software should not rely on the value of a reserved bit. To provide compatibility with future products, the value of a reserved bit should be preserved across a read-modify-write operation.
6	HIB	R/W	0	HIB Clock Gating Control  This bit controls the clock gating for the Hibernation module. If set, the unit receives a clock and functions. Otherwise, the unit is unlocked and disabled.
5:4	reserved	RO	0	Software should not rely on the value of a reserved bit. To provide compatibility with future products, the value of a reserved bit should be preserved across a read-modify-write operation.
3	WDT	R/W	0	WDT Clock Gating Control  This bit controls the clock gating for the WDT module. If set, the unit receives a clock and functions. Otherwise, the unit is unlocked and disabled. If the unit is unlocked, a read or write to the unit generates a bus fault.
2:0	reserved	RO	0	Software should not rely on the value of a reserved bit. To provide compatibility with future products, the value of a reserved bit should be preserved across a read-modify-write operation.

## Register 21: Run Mode Clock Gating Control Register 1 (RCGC1), offset 0x104

This register controls the clock gating logic. Each bit controls a clock enable for a given interface, function, or unit. If set, the unit receives a clock and functions. Otherwise, the unit is unlocked and disabled (saving power). If the unit is unlocked, reads or writes to the unit will generate a bus fault. The reset state of these bits is 0 (unlocked) unless otherwise noted, so that all functional units are disabled. It is the responsibility of software to enable the ports necessary for the application. Note that these registers may contain more bits than there are interfaces, functions, or units to control. This is to assure reasonable code compatibility with other family and future parts. **RCGC1** is the clock configuration register for running operation, **SCGC1** for Sleep operation, and **DCGC1** for Deep-Sleep operation. Setting the **ACG** bit in the **Run-Mode Clock Configuration (RCC)** register specifies that the system uses sleep modes.

### Run Mode Clock Gating Control Register 1 (RCGC1)

Base 0x400F.E000

Offset 0x104

Type R/W, reset 0x00000000

	31	30	29	28	27	26	25	24	23	22	21	20	19	18	17	16
	reserved					COMP2	COMP1	COMP0	reserved				TIMER3	TIMER2	TIMER1	TIMER0
Type	RO	RO	RO	RO	RO	R/W	R/W	R/W	RO	RO	RO	RO	R/W	R/W	R/W	R/W
Reset	0	0	0	0	0	0	0	0	0	0	0	0	0	0	0	0
	15	14	13	12	11	10	9	8	7	6	5	4	3	2	1	0
	reserved	I2C1	reserved	I2C0	reserved						SSI1	SSI0	reserved	UART2	UART1	UART0
Type	RO	R/W	RO	R/W	RO	RO	RO	RO	RO	RO	R/W	R/W	RO	R/W	R/W	R/W
Reset	0	0	0	0	0	0	0	0	0	0	0	0	0	0	0	0

Bit/Field	Name	Type	Reset	Description
31:27	reserved	RO	0	Software should not rely on the value of a reserved bit. To provide compatibility with future products, the value of a reserved bit should be preserved across a read-modify-write operation.
26	COMP2	R/W	0	<p>Analog Comparator 2 Clock Gating</p> <p>This bit controls the clock gating for analog comparator 2. If set, the unit receives a clock and functions. Otherwise, the unit is unlocked and disabled. If the unit is unlocked, reads or writes to the unit will generate a bus fault.</p>
25	COMP1	R/W	0	<p>Analog Comparator 1 Clock Gating</p> <p>This bit controls the clock gating for analog comparator 1. If set, the unit receives a clock and functions. Otherwise, the unit is unlocked and disabled. If the unit is unlocked, reads or writes to the unit will generate a bus fault.</p>
24	COMP0	R/W	0	<p>Analog Comparator 0 Clock Gating</p> <p>This bit controls the clock gating for analog comparator 0. If set, the unit receives a clock and functions. Otherwise, the unit is unlocked and disabled. If the unit is unlocked, reads or writes to the unit will generate a bus fault.</p>
23:20	reserved	RO	0	Software should not rely on the value of a reserved bit. To provide compatibility with future products, the value of a reserved bit should be preserved across a read-modify-write operation.

Bit/Field	Name	Type	Reset	Description
19	TIMER3	R/W	0	<p>Timer 3 Clock Gating Control</p> <p>This bit controls the clock gating for General-Purpose Timer module 3. If set, the unit receives a clock and functions. Otherwise, the unit is unlocked and disabled. If the unit is unlocked, reads or writes to the unit will generate a bus fault.</p>
18	TIMER2	R/W	0	<p>Timer 2 Clock Gating Control</p> <p>This bit controls the clock gating for General-Purpose Timer module 2. If set, the unit receives a clock and functions. Otherwise, the unit is unlocked and disabled. If the unit is unlocked, reads or writes to the unit will generate a bus fault.</p>
17	TIMER1	R/W	0	<p>Timer 1 Clock Gating Control</p> <p>This bit controls the clock gating for General-Purpose Timer module 1. If set, the unit receives a clock and functions. Otherwise, the unit is unlocked and disabled. If the unit is unlocked, reads or writes to the unit will generate a bus fault.</p>
16	TIMER0	R/W	0	<p>Timer 0 Clock Gating Control</p> <p>This bit controls the clock gating for General-Purpose Timer module 0. If set, the unit receives a clock and functions. Otherwise, the unit is unlocked and disabled. If the unit is unlocked, reads or writes to the unit will generate a bus fault.</p>
15	reserved	RO	0	<p>Software should not rely on the value of a reserved bit. To provide compatibility with future products, the value of a reserved bit should be preserved across a read-modify-write operation.</p>
14	I2C1	R/W	0	<p>I2C1 Clock Gating Control</p> <p>This bit controls the clock gating for I2C module 1. If set, the unit receives a clock and functions. Otherwise, the unit is unlocked and disabled. If the unit is unlocked, reads or writes to the unit will generate a bus fault.</p>
13	reserved	RO	0	<p>Software should not rely on the value of a reserved bit. To provide compatibility with future products, the value of a reserved bit should be preserved across a read-modify-write operation.</p>
12	I2C0	R/W	0	<p>I2C0 Clock Gating Control</p> <p>This bit controls the clock gating for I2C module 0. If set, the unit receives a clock and functions. Otherwise, the unit is unlocked and disabled. If the unit is unlocked, reads or writes to the unit will generate a bus fault.</p>
11:6	reserved	RO	0	<p>Software should not rely on the value of a reserved bit. To provide compatibility with future products, the value of a reserved bit should be preserved across a read-modify-write operation.</p>
5	SSI1	R/W	0	<p>SSI1 Clock Gating Control</p> <p>This bit controls the clock gating for SSI module 1. If set, the unit receives a clock and functions. Otherwise, the unit is unlocked and disabled. If the unit is unlocked, reads or writes to the unit will generate a bus fault.</p>
4	SSI0	R/W	0	<p>SSI0 Clock Gating Control</p> <p>This bit controls the clock gating for SSI module 0. If set, the unit receives a clock and functions. Otherwise, the unit is unlocked and disabled. If the unit is unlocked, reads or writes to the unit will generate a bus fault.</p>



---

Bit/Field	Name	Type	Reset	Description
3	reserved	RO	0	Software should not rely on the value of a reserved bit. To provide compatibility with future products, the value of a reserved bit should be preserved across a read-modify-write operation.
2	UART2	R/W	0	UART2 Clock Gating Control  This bit controls the clock gating for UART module 2. If set, the unit receives a clock and functions. Otherwise, the unit is unlocked and disabled. If the unit is unlocked, reads or writes to the unit will generate a bus fault.
1	UART1	R/W	0	UART1 Clock Gating Control  This bit controls the clock gating for UART module 1. If set, the unit receives a clock and functions. Otherwise, the unit is unlocked and disabled. If the unit is unlocked, reads or writes to the unit will generate a bus fault.
0	UART0	R/W	0	UART0 Clock Gating Control  This bit controls the clock gating for UART module 0. If set, the unit receives a clock and functions. Otherwise, the unit is unlocked and disabled. If the unit is unlocked, reads or writes to the unit will generate a bus fault.

## Register 22: Sleep Mode Clock Gating Control Register 1 (SCGC1), offset 0x114

This register controls the clock gating logic. Each bit controls a clock enable for a given interface, function, or unit. If set, the unit receives a clock and functions. Otherwise, the unit is unlocked and disabled (saving power). If the unit is unlocked, reads or writes to the unit will generate a bus fault. The reset state of these bits is 0 (unlocked) unless otherwise noted, so that all functional units are disabled. It is the responsibility of software to enable the ports necessary for the application. Note that these registers may contain more bits than there are interfaces, functions, or units to control. This is to assure reasonable code compatibility with other family and future parts. **RCGC1** is the clock configuration register for running operation, **SCGC1** for Sleep operation, and **DCGC1** for Deep-Sleep operation. Setting the **ACG** bit in the **Run-Mode Clock Configuration (RCC)** register specifies that the system uses sleep modes.

### Sleep Mode Clock Gating Control Register 1 (SCGC1)

Base 0x400F.E000

Offset 0x114

Type R/W, reset 0x00000000

	31	30	29	28	27	26	25	24	23	22	21	20	19	18	17	16
	reserved					COMP2	COMP1	COMP0	reserved				TIMER3	TIMER2	TIMER1	TIMER0
Type	RO	RO	RO	RO	RO	R/W	R/W	R/W	RO	RO	RO	RO	R/W	R/W	R/W	R/W
Reset	0	0	0	0	0	0	0	0	0	0	0	0	0	0	0	0
	15	14	13	12	11	10	9	8	7	6	5	4	3	2	1	0
	reserved	I2C1	reserved	I2C0	reserved						SSI1	SSI0	reserved	UART2	UART1	UART0
Type	RO	R/W	RO	R/W	RO	RO	RO	RO	RO	RO	R/W	R/W	RO	R/W	R/W	R/W
Reset	0	0	0	0	0	0	0	0	0	0	0	0	0	0	0	0

Bit/Field	Name	Type	Reset	Description
31:27	reserved	RO	0	Software should not rely on the value of a reserved bit. To provide compatibility with future products, the value of a reserved bit should be preserved across a read-modify-write operation.
26	COMP2	R/W	0	Analog Comparator 2 Clock Gating  This bit controls the clock gating for analog comparator 2. If set, the unit receives a clock and functions. Otherwise, the unit is unlocked and disabled. If the unit is unlocked, reads or writes to the unit will generate a bus fault.
25	COMP1	R/W	0	Analog Comparator 1 Clock Gating  This bit controls the clock gating for analog comparator 1. If set, the unit receives a clock and functions. Otherwise, the unit is unlocked and disabled. If the unit is unlocked, reads or writes to the unit will generate a bus fault.
24	COMP0	R/W	0	Analog Comparator 0 Clock Gating  This bit controls the clock gating for analog comparator 0. If set, the unit receives a clock and functions. Otherwise, the unit is unlocked and disabled. If the unit is unlocked, reads or writes to the unit will generate a bus fault.
23:20	reserved	RO	0	Software should not rely on the value of a reserved bit. To provide compatibility with future products, the value of a reserved bit should be preserved across a read-modify-write operation.

Bit/Field	Name	Type	Reset	Description
19	TIMER3	R/W	0	<p>Timer 3 Clock Gating Control</p> <p>This bit controls the clock gating for General-Purpose Timer module 3. If set, the unit receives a clock and functions. Otherwise, the unit is unlocked and disabled. If the unit is unlocked, reads or writes to the unit will generate a bus fault.</p>
18	TIMER2	R/W	0	<p>Timer 2 Clock Gating Control</p> <p>This bit controls the clock gating for General-Purpose Timer module 2. If set, the unit receives a clock and functions. Otherwise, the unit is unlocked and disabled. If the unit is unlocked, reads or writes to the unit will generate a bus fault.</p>
17	TIMER1	R/W	0	<p>Timer 1 Clock Gating Control</p> <p>This bit controls the clock gating for General-Purpose Timer module 1. If set, the unit receives a clock and functions. Otherwise, the unit is unlocked and disabled. If the unit is unlocked, reads or writes to the unit will generate a bus fault.</p>
16	TIMER0	R/W	0	<p>Timer 0 Clock Gating Control</p> <p>This bit controls the clock gating for General-Purpose Timer module 0. If set, the unit receives a clock and functions. Otherwise, the unit is unlocked and disabled. If the unit is unlocked, reads or writes to the unit will generate a bus fault.</p>
15	reserved	RO	0	Software should not rely on the value of a reserved bit. To provide compatibility with future products, the value of a reserved bit should be preserved across a read-modify-write operation.
14	I2C1	R/W	0	<p>I2C1 Clock Gating Control</p> <p>This bit controls the clock gating for I2C module 1. If set, the unit receives a clock and functions. Otherwise, the unit is unlocked and disabled. If the unit is unlocked, reads or writes to the unit will generate a bus fault.</p>
13	reserved	RO	0	Software should not rely on the value of a reserved bit. To provide compatibility with future products, the value of a reserved bit should be preserved across a read-modify-write operation.
12	I2C0	R/W	0	<p>I2C0 Clock Gating Control</p> <p>This bit controls the clock gating for I2C module 0. If set, the unit receives a clock and functions. Otherwise, the unit is unlocked and disabled. If the unit is unlocked, reads or writes to the unit will generate a bus fault.</p>
11:6	reserved	RO	0	Software should not rely on the value of a reserved bit. To provide compatibility with future products, the value of a reserved bit should be preserved across a read-modify-write operation.
5	SSI1	R/W	0	<p>SSI1 Clock Gating Control</p> <p>This bit controls the clock gating for SSI module 1. If set, the unit receives a clock and functions. Otherwise, the unit is unlocked and disabled. If the unit is unlocked, reads or writes to the unit will generate a bus fault.</p>
4	SSI0	R/W	0	<p>SSI0 Clock Gating Control</p> <p>This bit controls the clock gating for SSI module 0. If set, the unit receives a clock and functions. Otherwise, the unit is unlocked and disabled. If the unit is unlocked, reads or writes to the unit will generate a bus fault.</p>

Bit/Field	Name	Type	Reset	Description
3	reserved	RO	0	Software should not rely on the value of a reserved bit. To provide compatibility with future products, the value of a reserved bit should be preserved across a read-modify-write operation.
2	UART2	R/W	0	UART2 Clock Gating Control  This bit controls the clock gating for UART module 2. If set, the unit receives a clock and functions. Otherwise, the unit is unlocked and disabled. If the unit is unlocked, reads or writes to the unit will generate a bus fault.
1	UART1	R/W	0	UART1 Clock Gating Control  This bit controls the clock gating for UART module 1. If set, the unit receives a clock and functions. Otherwise, the unit is unlocked and disabled. If the unit is unlocked, reads or writes to the unit will generate a bus fault.
0	UART0	R/W	0	UART0 Clock Gating Control  This bit controls the clock gating for UART module 0. If set, the unit receives a clock and functions. Otherwise, the unit is unlocked and disabled. If the unit is unlocked, reads or writes to the unit will generate a bus fault.

## Register 23: Deep Sleep Mode Clock Gating Control Register 1 (DCGC1), offset 0x124

This register controls the clock gating logic. Each bit controls a clock enable for a given interface, function, or unit. If set, the unit receives a clock and functions. Otherwise, the unit is unlocked and disabled (saving power). If the unit is unlocked, reads or writes to the unit will generate a bus fault. The reset state of these bits is 0 (unlocked) unless otherwise noted, so that all functional units are disabled. It is the responsibility of software to enable the ports necessary for the application. Note that these registers may contain more bits than there are interfaces, functions, or units to control. This is to assure reasonable code compatibility with other family and future parts. **RCGC1** is the clock configuration register for running operation, **SCGC1** for Sleep operation, and **DCGC1** for Deep-Sleep operation. Setting the **ACG** bit in the **Run-Mode Clock Configuration (RCC)** register specifies that the system uses sleep modes.

### Deep Sleep Mode Clock Gating Control Register 1 (DCGC1)

Base 0x400F.E000

Offset 0x124

Type R/W, reset 0x00000000

	31	30	29	28	27	26	25	24	23	22	21	20	19	18	17	16
	reserved					COMP2	COMP1	COMP0	reserved				TIMER3	TIMER2	TIMER1	TIMER0
Type	RO	RO	RO	RO	RO	R/W	R/W	R/W	RO	RO	RO	RO	R/W	R/W	R/W	R/W
Reset	0	0	0	0	0	0	0	0	0	0	0	0	0	0	0	0
	15	14	13	12	11	10	9	8	7	6	5	4	3	2	1	0
	reserved	I2C1	reserved	I2C0	reserved						SSI1	SSI0	reserved	UART2	UART1	UART0
Type	RO	R/W	RO	R/W	RO	RO	RO	RO	RO	RO	R/W	R/W	RO	R/W	R/W	R/W
Reset	0	0	0	0	0	0	0	0	0	0	0	0	0	0	0	0

Bit/Field	Name	Type	Reset	Description
31:27	reserved	RO	0	Software should not rely on the value of a reserved bit. To provide compatibility with future products, the value of a reserved bit should be preserved across a read-modify-write operation.
26	COMP2	R/W	0	Analog Comparator 2 Clock Gating  This bit controls the clock gating for analog comparator 2. If set, the unit receives a clock and functions. Otherwise, the unit is unlocked and disabled. If the unit is unlocked, reads or writes to the unit will generate a bus fault.
25	COMP1	R/W	0	Analog Comparator 1 Clock Gating  This bit controls the clock gating for analog comparator 1. If set, the unit receives a clock and functions. Otherwise, the unit is unlocked and disabled. If the unit is unlocked, reads or writes to the unit will generate a bus fault.
24	COMP0	R/W	0	Analog Comparator 0 Clock Gating  This bit controls the clock gating for analog comparator 0. If set, the unit receives a clock and functions. Otherwise, the unit is unlocked and disabled. If the unit is unlocked, reads or writes to the unit will generate a bus fault.
23:20	reserved	RO	0	Software should not rely on the value of a reserved bit. To provide compatibility with future products, the value of a reserved bit should be preserved across a read-modify-write operation.

Bit/Field	Name	Type	Reset	Description
19	TIMER3	R/W	0	<p>Timer 3 Clock Gating Control</p> <p>This bit controls the clock gating for General-Purpose Timer module 3. If set, the unit receives a clock and functions. Otherwise, the unit is unlocked and disabled. If the unit is unlocked, reads or writes to the unit will generate a bus fault.</p>
18	TIMER2	R/W	0	<p>Timer 2 Clock Gating Control</p> <p>This bit controls the clock gating for General-Purpose Timer module 2. If set, the unit receives a clock and functions. Otherwise, the unit is unlocked and disabled. If the unit is unlocked, reads or writes to the unit will generate a bus fault.</p>
17	TIMER1	R/W	0	<p>Timer 1 Clock Gating Control</p> <p>This bit controls the clock gating for General-Purpose Timer module 1. If set, the unit receives a clock and functions. Otherwise, the unit is unlocked and disabled. If the unit is unlocked, reads or writes to the unit will generate a bus fault.</p>
16	TIMER0	R/W	0	<p>Timer 0 Clock Gating Control</p> <p>This bit controls the clock gating for General-Purpose Timer module 0. If set, the unit receives a clock and functions. Otherwise, the unit is unlocked and disabled. If the unit is unlocked, reads or writes to the unit will generate a bus fault.</p>
15	reserved	RO	0	Software should not rely on the value of a reserved bit. To provide compatibility with future products, the value of a reserved bit should be preserved across a read-modify-write operation.
14	I2C1	R/W	0	<p>I2C1 Clock Gating Control</p> <p>This bit controls the clock gating for I2C module 1. If set, the unit receives a clock and functions. Otherwise, the unit is unlocked and disabled. If the unit is unlocked, reads or writes to the unit will generate a bus fault.</p>
13	reserved	RO	0	Software should not rely on the value of a reserved bit. To provide compatibility with future products, the value of a reserved bit should be preserved across a read-modify-write operation.
12	I2C0	R/W	0	<p>I2C0 Clock Gating Control</p> <p>This bit controls the clock gating for I2C module 0. If set, the unit receives a clock and functions. Otherwise, the unit is unlocked and disabled. If the unit is unlocked, reads or writes to the unit will generate a bus fault.</p>
11:6	reserved	RO	0	Software should not rely on the value of a reserved bit. To provide compatibility with future products, the value of a reserved bit should be preserved across a read-modify-write operation.
5	SSI1	R/W	0	<p>SSI1 Clock Gating Control</p> <p>This bit controls the clock gating for SSI module 1. If set, the unit receives a clock and functions. Otherwise, the unit is unlocked and disabled. If the unit is unlocked, reads or writes to the unit will generate a bus fault.</p>
4	SSI0	R/W	0	<p>SSI0 Clock Gating Control</p> <p>This bit controls the clock gating for SSI module 0. If set, the unit receives a clock and functions. Otherwise, the unit is unlocked and disabled. If the unit is unlocked, reads or writes to the unit will generate a bus fault.</p>

---

Bit/Field	Name	Type	Reset	Description
3	reserved	RO	0	Software should not rely on the value of a reserved bit. To provide compatibility with future products, the value of a reserved bit should be preserved across a read-modify-write operation.
2	UART2	R/W	0	UART2 Clock Gating Control  This bit controls the clock gating for UART module 2. If set, the unit receives a clock and functions. Otherwise, the unit is unclocked and disabled. If the unit is unclocked, reads or writes to the unit will generate a bus fault.
1	UART1	R/W	0	UART1 Clock Gating Control  This bit controls the clock gating for UART module 1. If set, the unit receives a clock and functions. Otherwise, the unit is unclocked and disabled. If the unit is unclocked, reads or writes to the unit will generate a bus fault.
0	UART0	R/W	0	UART0 Clock Gating Control  This bit controls the clock gating for UART module 0. If set, the unit receives a clock and functions. Otherwise, the unit is unclocked and disabled. If the unit is unclocked, reads or writes to the unit will generate a bus fault.

## Register 24: Run Mode Clock Gating Control Register 2 (RCGC2), offset 0x108

This register controls the clock gating logic. Each bit controls a clock enable for a given interface, function, or unit. If set, the unit receives a clock and functions. Otherwise, the unit is unclocked and disabled (saving power). If the unit is unclocked, reads or writes to the unit will generate a bus fault. The reset state of these bits is 0 (unclocked) unless otherwise noted, so that all functional units are disabled. It is the responsibility of software to enable the ports necessary for the application. Note that these registers may contain more bits than there are interfaces, functions, or units to control. This is to assure reasonable code compatibility with other family and future parts. **RCGC2** is the clock configuration register for running operation, **SCGC2** for Sleep operation, and **DCGC2** for Deep-Sleep operation. Setting the **ACG** bit in the **Run-Mode Clock Configuration (RCC)** register specifies that the system uses sleep modes.

### Run Mode Clock Gating Control Register 2 (RCGC2)

Base 0x400F.E000

Offset 0x108

Type R/W, reset 0x00000000

	31	30	29	28	27	26	25	24	23	22	21	20	19	18	17	16
	reserved															
Type	RO	RO	RO	RO	RO	RO	RO	RO	RO	RO	RO	RO	RO	RO	RO	RO
Reset	0	0	0	0	0	0	0	0	0	0	0	0	0	0	0	0
	15	14	13	12	11	10	9	8	7	6	5	4	3	2	1	0
	reserved								GPIOH	GPIOG	GPIOF	GPIOE	GPIOD	GPIOC	GPIOB	GPIOA
Type	RO	RO	RO	RO	RO	RO	RO	RO	R/W	R/W	R/W	R/W	R/W	R/W	R/W	R/W
Reset	0	0	0	0	0	0	0	0	0	0	0	0	0	0	0	0

Bit/Field	Name	Type	Reset	Description
31:8	reserved	RO	0	Software should not rely on the value of a reserved bit. To provide compatibility with future products, the value of a reserved bit should be preserved across a read-modify-write operation.
7	GPIOH	R/W	0	Port H Clock Gating Control  This bit controls the clock gating for Port H. If set, the unit receives a clock and functions. Otherwise, the unit is unclocked and disabled. If the unit is unclocked, reads or writes to the unit will generate a bus fault.
6	GPIOG	R/W	0	Port G Clock Gating Control  This bit controls the clock gating for Port G. If set, the unit receives a clock and functions. Otherwise, the unit is unclocked and disabled. If the unit is unclocked, reads or writes to the unit will generate a bus fault.
5	GPIOF	R/W	0	Port F Clock Gating Control  This bit controls the clock gating for Port F. If set, the unit receives a clock and functions. Otherwise, the unit is unclocked and disabled. If the unit is unclocked, reads or writes to the unit will generate a bus fault.
4	GPIOE	R/W	0	Port E Clock Gating Control  This bit controls the clock gating for Port E. If set, the unit receives a clock and functions. Otherwise, the unit is unclocked and disabled. If the unit is unclocked, reads or writes to the unit will generate a bus fault.



---

Bit/Field	Name	Type	Reset	Description
3	GPIOD	R/W	0	Port D Clock Gating Control  This bit controls the clock gating for Port D. If set, the unit receives a clock and functions. Otherwise, the unit is unlocked and disabled. If the unit is unlocked, reads or writes to the unit will generate a bus fault.
2	GPIOC	R/W	0	Port C Clock Gating Control  This bit controls the clock gating for Port C. If set, the unit receives a clock and functions. Otherwise, the unit is unlocked and disabled. If the unit is unlocked, reads or writes to the unit will generate a bus fault.
1	GPIOB	R/W	0	Port B Clock Gating Control  This bit controls the clock gating for Port B. If set, the unit receives a clock and functions. Otherwise, the unit is unlocked and disabled. If the unit is unlocked, reads or writes to the unit will generate a bus fault.
0	GPIOA	R/W	0	Port A Clock Gating Control  This bit controls the clock gating for Port A. If set, the unit receives a clock and functions. Otherwise, the unit is unlocked and disabled. If the unit is unlocked, reads or writes to the unit will generate a bus fault.

## Register 25: Sleep Mode Clock Gating Control Register 2 (SCGC2), offset 0x118

This register controls the clock gating logic. Each bit controls a clock enable for a given interface, function, or unit. If set, the unit receives a clock and functions. Otherwise, the unit is unlocked and disabled (saving power). If the unit is unlocked, reads or writes to the unit will generate a bus fault. The reset state of these bits is 0 (unlocked) unless otherwise noted, so that all functional units are disabled. It is the responsibility of software to enable the ports necessary for the application. Note that these registers may contain more bits than there are interfaces, functions, or units to control. This is to assure reasonable code compatibility with other family and future parts. **RCGC2** is the clock configuration register for running operation, **SCGC2** for Sleep operation, and **DCGC2** for Deep-Sleep operation. Setting the **ACG** bit in the **Run-Mode Clock Configuration (RCC)** register specifies that the system uses sleep modes.

### Sleep Mode Clock Gating Control Register 2 (SCGC2)

Base 0x400F.E000

Offset 0x118

Type R/W, reset 0x00000000

	31	30	29	28	27	26	25	24	23	22	21	20	19	18	17	16
	reserved															
Type	RO	RO	RO	RO	RO	RO	RO	RO	RO	RO	RO	RO	RO	RO	RO	RO
Reset	0	0	0	0	0	0	0	0	0	0	0	0	0	0	0	0
	15	14	13	12	11	10	9	8	7	6	5	4	3	2	1	0
	reserved								GPIOH	GPIOG	GPIOF	GPIOE	GPIOD	GPIOC	GPIOB	GPIOA
Type	RO	RO	RO	RO	RO	RO	RO	RO	R/W	R/W	R/W	R/W	R/W	R/W	R/W	R/W
Reset	0	0	0	0	0	0	0	0	0	0	0	0	0	0	0	0

Bit/Field	Name	Type	Reset	Description
31:8	reserved	RO	0	Software should not rely on the value of a reserved bit. To provide compatibility with future products, the value of a reserved bit should be preserved across a read-modify-write operation.
7	GPIOH	R/W	0	Port H Clock Gating Control  This bit controls the clock gating for Port H. If set, the unit receives a clock and functions. Otherwise, the unit is unlocked and disabled. If the unit is unlocked, reads or writes to the unit will generate a bus fault.
6	GPIOG	R/W	0	Port G Clock Gating Control  This bit controls the clock gating for Port G. If set, the unit receives a clock and functions. Otherwise, the unit is unlocked and disabled. If the unit is unlocked, reads or writes to the unit will generate a bus fault.
5	GPIOF	R/W	0	Port F Clock Gating Control  This bit controls the clock gating for Port F. If set, the unit receives a clock and functions. Otherwise, the unit is unlocked and disabled. If the unit is unlocked, reads or writes to the unit will generate a bus fault.
4	GPIOE	R/W	0	Port E Clock Gating Control  This bit controls the clock gating for Port E. If set, the unit receives a clock and functions. Otherwise, the unit is unlocked and disabled. If the unit is unlocked, reads or writes to the unit will generate a bus fault.

---

Bit/Field	Name	Type	Reset	Description
3	GPIOD	R/W	0	Port D Clock Gating Control  This bit controls the clock gating for Port D. If set, the unit receives a clock and functions. Otherwise, the unit is unlocked and disabled. If the unit is unlocked, reads or writes to the unit will generate a bus fault.
2	GPIOC	R/W	0	Port C Clock Gating Control  This bit controls the clock gating for Port C. If set, the unit receives a clock and functions. Otherwise, the unit is unlocked and disabled. If the unit is unlocked, reads or writes to the unit will generate a bus fault.
1	GPIOB	R/W	0	Port B Clock Gating Control  This bit controls the clock gating for Port B. If set, the unit receives a clock and functions. Otherwise, the unit is unlocked and disabled. If the unit is unlocked, reads or writes to the unit will generate a bus fault.
0	GPIOA	R/W	0	Port A Clock Gating Control  This bit controls the clock gating for Port A. If set, the unit receives a clock and functions. Otherwise, the unit is unlocked and disabled. If the unit is unlocked, reads or writes to the unit will generate a bus fault.

## Register 26: Deep Sleep Mode Clock Gating Control Register 2 (DCGC2), offset 0x128

This register controls the clock gating logic. Each bit controls a clock enable for a given interface, function, or unit. If set, the unit receives a clock and functions. Otherwise, the unit is unlocked and disabled (saving power). If the unit is unlocked, reads or writes to the unit will generate a bus fault. The reset state of these bits is 0 (unlocked) unless otherwise noted, so that all functional units are disabled. It is the responsibility of software to enable the ports necessary for the application. Note that these registers may contain more bits than there are interfaces, functions, or units to control. This is to assure reasonable code compatibility with other family and future parts. **RCGC2** is the clock configuration register for running operation, **SCGC2** for Sleep operation, and **DCGC2** for Deep-Sleep operation. Setting the **ACG** bit in the **Run-Mode Clock Configuration (RCC)** register specifies that the system uses sleep modes.

### Deep Sleep Mode Clock Gating Control Register 2 (DCGC2)

Base 0x400F.E000  
 Offset 0x128  
 Type R/W, reset 0x00000000

	31	30	29	28	27	26	25	24	23	22	21	20	19	18	17	16
	reserved															
Type	RO	RO	RO	RO	RO	RO	RO	RO	RO	RO	RO	RO	RO	RO	RO	RO
Reset	0	0	0	0	0	0	0	0	0	0	0	0	0	0	0	0
	15	14	13	12	11	10	9	8	7	6	5	4	3	2	1	0
	reserved								GPIOH	GPIOG	GPIOF	GPIOE	GPIOD	GPIOC	GPIOB	GPIOA
Type	RO	RO	RO	RO	RO	RO	RO	RO	R/W	R/W	R/W	R/W	R/W	R/W	R/W	R/W
Reset	0	0	0	0	0	0	0	0	0	0	0	0	0	0	0	0

Bit/Field	Name	Type	Reset	Description
31:8	reserved	RO	0	Software should not rely on the value of a reserved bit. To provide compatibility with future products, the value of a reserved bit should be preserved across a read-modify-write operation.
7	GPIOH	R/W	0	Port H Clock Gating Control  This bit controls the clock gating for Port H. If set, the unit receives a clock and functions. Otherwise, the unit is unlocked and disabled. If the unit is unlocked, reads or writes to the unit will generate a bus fault.
6	GPIOG	R/W	0	Port G Clock Gating Control  This bit controls the clock gating for Port G. If set, the unit receives a clock and functions. Otherwise, the unit is unlocked and disabled. If the unit is unlocked, reads or writes to the unit will generate a bus fault.
5	GPIOF	R/W	0	Port F Clock Gating Control  This bit controls the clock gating for Port F. If set, the unit receives a clock and functions. Otherwise, the unit is unlocked and disabled. If the unit is unlocked, reads or writes to the unit will generate a bus fault.
4	GPIOE	R/W	0	Port E Clock Gating Control  This bit controls the clock gating for Port E. If set, the unit receives a clock and functions. Otherwise, the unit is unlocked and disabled. If the unit is unlocked, reads or writes to the unit will generate a bus fault.

---

Bit/Field	Name	Type	Reset	Description
3	GPIOD	R/W	0	Port D Clock Gating Control  This bit controls the clock gating for Port D. If set, the unit receives a clock and functions. Otherwise, the unit is unlocked and disabled. If the unit is unlocked, reads or writes to the unit will generate a bus fault.
2	GPIOC	R/W	0	Port C Clock Gating Control  This bit controls the clock gating for Port C. If set, the unit receives a clock and functions. Otherwise, the unit is unlocked and disabled. If the unit is unlocked, reads or writes to the unit will generate a bus fault.
1	GPIOB	R/W	0	Port B Clock Gating Control  This bit controls the clock gating for Port B. If set, the unit receives a clock and functions. Otherwise, the unit is unlocked and disabled. If the unit is unlocked, reads or writes to the unit will generate a bus fault.
0	GPIOA	R/W	0	Port A Clock Gating Control  This bit controls the clock gating for Port A. If set, the unit receives a clock and functions. Otherwise, the unit is unlocked and disabled. If the unit is unlocked, reads or writes to the unit will generate a bus fault.

## Register 27: Software Reset Control 0 (SRCR0), offset 0x040

Writes to this register are masked by the bits in the **Device Capabilities 1 (DC1)** register.

### Software Reset Control 0 (SRCR0)

Base 0x400F.E000  
 Offset 0x040  
 Type R/W, reset 0x00000000

	31	30	29	28	27	26	25	24	23	22	21	20	19	18	17	16
	reserved															ADC
Type	RO	RO	RO	RO	RO	RO	RO	RO	RO	RO	RO	RO	RO	RO	RO	R/W
Reset	0	0	0	0	0	0	0	0	0	0	0	0	0	0	0	0
	15	14	13	12	11	10	9	8	7	6	5	4	3	2	1	0
	reserved							HIB	reserved		WDT	reserved				
Type	RO	RO	RO	RO	RO	RO	RO	RO	R/W	RO	RO	R/W	RO	RO	RO	
Reset	0	0	0	0	0	0	0	0	0	0	0	0	0	0	0	

Bit/Field	Name	Type	Reset	Description
31:17	reserved	RO	0	Software should not rely on the value of a reserved bit. To provide compatibility with future products, the value of a reserved bit should be preserved across a read-modify-write operation.
16	ADC	R/W	0	ADC0 Reset Control Reset control for SAR ADC module 0.
15:7	reserved	RO	0	Software should not rely on the value of a reserved bit. To provide compatibility with future products, the value of a reserved bit should be preserved across a read-modify-write operation.
6	HIB	R/W	0	HIB Reset Control Reset control for the Hibernation module.
5:4	reserved	RO	0	Software should not rely on the value of a reserved bit. To provide compatibility with future products, the value of a reserved bit should be preserved across a read-modify-write operation.
3	WDT	R/W	0	WDT Reset Control Reset control for Watchdog unit.
2:0	reserved	RO	0	Software should not rely on the value of a reserved bit. To provide compatibility with future products, the value of a reserved bit should be preserved across a read-modify-write operation.

**Register 28: Software Reset Control 1 (SRCR1), offset 0x044**Writes to this register are masked by the bits in the **Device Capabilities 2 (DC2)** register.

## Software Reset Control 1 (SRCR1)

Base 0x400F.E000

Offset 0x044

Type R/W, reset 0x00000000

	31	30	29	28	27	26	25	24	23	22	21	20	19	18	17	16	
	reserved					COMP2	COMP1	COMP0	reserved				TIMER3	TIMER2	TIMER1	TIMER0	
Type	RO	RO	RO	RO	RO	R/W	R/W	R/W	RO	RO	RO	RO	R/W	R/W	R/W	R/W	
Reset	0	0	0	0	0	0	0	0	0	0	0	0	0	0	0	0	
	15	14	13	12	11	10	9	8	7	6	5	4	3	2	1	0	
	reserved	I2C1	reserved	I2C0	reserved							SSI1	SSI0	reserved	UART2	UART1	UART0
Type	RO	R/W	RO	R/W	RO	RO	RO	RO	RO	RO	R/W	R/W	RO	R/W	R/W	R/W	
Reset	0	0	0	0	0	0	0	0	0	0	0	0	0	0	0	0	

Bit/Field	Name	Type	Reset	Description
31:27	reserved	RO	0	Software should not rely on the value of a reserved bit. To provide compatibility with future products, the value of a reserved bit should be preserved across a read-modify-write operation.
26	COMP2	R/W	0	Analog Comp 2 Reset Control Reset control for analog comparator 2.
25	COMP1	R/W	0	Analog Comp 1 Reset Control Reset control for analog comparator 1.
24	COMP0	R/W	0	Analog Comp 0 Reset Control Reset control for analog comparator 0.
23:20	reserved	RO	0	Software should not rely on the value of a reserved bit. To provide compatibility with future products, the value of a reserved bit should be preserved across a read-modify-write operation.
19	TIMER3	R/W	0	Timer 3 Reset Control Reset control for General-Purpose Timer module 3.
18	TIMER2	R/W	0	Timer 2 Reset Control Reset control for General-Purpose Timer module 2.
17	TIMER1	R/W	0	Timer 1 Reset Control Reset control for General-Purpose Timer module 1.
16	TIMER0	R/W	0	Timer 0 Reset Control Reset control for General-Purpose Timer module 0.
15	reserved	RO	0	Software should not rely on the value of a reserved bit. To provide compatibility with future products, the value of a reserved bit should be preserved across a read-modify-write operation.
14	I2C1	R/W	0	I2C1 Reset Control Reset control for I2C unit 1.

Bit/Field	Name	Type	Reset	Description
13	reserved	RO	0	Software should not rely on the value of a reserved bit. To provide compatibility with future products, the value of a reserved bit should be preserved across a read-modify-write operation.
12	I2C0	R/W	0	I2C0 Reset Control Reset control for I2C unit 0.
11:6	reserved	RO	0	Software should not rely on the value of a reserved bit. To provide compatibility with future products, the value of a reserved bit should be preserved across a read-modify-write operation.
5	SSI1	R/W	0	SSI1 Reset Control Reset control for SSI unit 1.
4	SSI0	R/W	0	SSI0 Reset Control Reset control for SSI unit 0.
3	reserved	RO	0	Software should not rely on the value of a reserved bit. To provide compatibility with future products, the value of a reserved bit should be preserved across a read-modify-write operation.
2	UART2	R/W	0	UART2 Reset Control Reset control for UART unit 2.
1	UART1	R/W	0	UART1 Reset Control Reset control for UART unit 1.
0	UART0	R/W	0	UART0 Reset Control Reset control for UART unit 0.



**Register 29: Software Reset Control 2 (SRCR2), offset 0x048**Writes to this register are masked by the bits in the **Device Capabilities 4 (DC4)** register.

## Software Reset Control 2 (SRCR2)

Base 0x400F.E000

Offset 0x048

Type R/W, reset 0x00000000

	31	30	29	28	27	26	25	24	23	22	21	20	19	18	17	16
	reserved															
Type	RO	RO	RO	RO	RO	RO	RO	RO	RO	RO	RO	RO	RO	RO	RO	RO
Reset	0	0	0	0	0	0	0	0	0	0	0	0	0	0	0	0
	15	14	13	12	11	10	9	8	7	6	5	4	3	2	1	0
	reserved								GPIOH	GPIOG	GPIOF	GPIOE	GPIOD	GPIOC	GPIOB	GPIOA
Type	RO	RO	RO	RO	RO	RO	RO	RO	R/W	R/W	R/W	R/W	R/W	R/W	R/W	R/W
Reset	0	0	0	0	0	0	0	0	0	0	0	0	0	0	0	0

Bit/Field	Name	Type	Reset	Description
31:8	reserved	RO	0	Software should not rely on the value of a reserved bit. To provide compatibility with future products, the value of a reserved bit should be preserved across a read-modify-write operation.
7	GPIOH	R/W	0	Port H Reset Control Reset control for GPIO Port H.
6	GPIOG	R/W	0	Port G Reset Control Reset control for GPIO Port G.
5	GPIOF	R/W	0	Port F Reset Control Reset control for GPIO Port F.
4	GPIOE	R/W	0	Port E Reset Control Reset control for GPIO Port E.
3	GPIOD	R/W	0	Port D Reset Control Reset control for GPIO Port D.
2	GPIOC	R/W	0	Port C Reset Control Reset control for GPIO Port C.
1	GPIOB	R/W	0	Port B Reset Control Reset control for GPIO Port B.
0	GPIOA	R/W	0	Port A Reset Control Reset control for GPIO Port A.

## 7 Hibernation Module

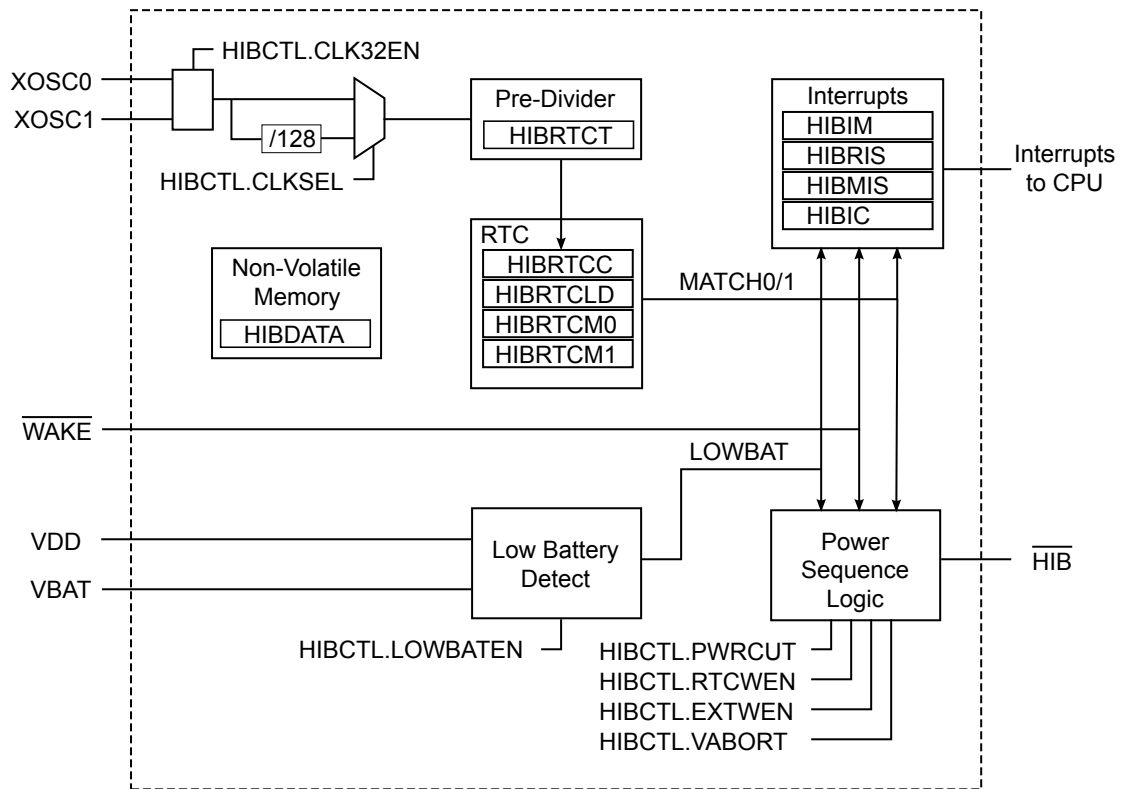
The Hibernation Module manages removal and restoration of power to the rest of the microcontroller to provide a means for reducing power consumption. When the processor and peripherals are idle, power can be completely removed with only the Hibernation Module remaining powered. Power can be restored based on an external signal, or at a certain time using the built-in real-time clock (RTC). The Hibernation module can be independently supplied from a battery or an auxillary power supply.

The Hibernation module has the following features:

- Power-switching logic to discrete external regulator
- Dedicated pin for waking from an external signal
- Low-battery detection, signalling, and interrupt generation
- 32-bit real-time counter (RTC)
- Two 32-bit RTC match registers for timed wake-up and interrupt generation
- Clock source from a 32.768-kHz external oscillator or a 4.194304-MHz crystal
- RTC predivider trim for making fine adjustments to the clock rate
- 64 32-bit words of non-volatile memory
- Programmable interrupts for RTC match, external wake, and low battery events

## 7.1 Block Diagram

Figure 7-1. Hibernation Module Block Diagram



## 7.2 Functional Description

The Hibernation module controls the power to the processor with an enable signal ( $\overline{HIB}$ ) that signals an external voltage regulator to turn off. The Hibernation module power is determined dynamically. The supply voltage of the Hibernation module is the larger of the main voltage source (VDD) or the battery/auxilliary voltage source (VBAT). A voting circuit indicates the larger and an internal power switch selects the appropriate voltage source. The Hibernation module also has a separate clock source to maintain a real-time clock (RTC). Once in hibernation, the module signals an external voltage regulator to turn back on the power when an external pin ( $\overline{WAKE}$ ) is asserted, or when the internal RTC reaches a certain value. The Hibernation module can also detect when the battery voltage is low, and optionally prevent hibernation when this occurs.

Power-up from a power cut to code execution is defined as the regulator turn-on time (specified at  $t_{HIB\_TO\_VDD}$  maximum) plus the normal chip POR (see "Hibernation Module" on page 436).

### 7.2.1 Register Access Timing

Because the Hibernation module has an independent clocking domain, certain registers must be written only with a timing gap between accesses. The delay time is  $t_{HIB\_REG\_WRITE}$ , therefore software must guarantee that a delay of  $t_{HIB\_REG\_WRITE}$  is inserted between back-to-back writes to certain Hibernation registers, or between a write followed by a read to those same registers. There is no

restriction on timing for back-to-back reads from the Hibernation module. Refer to “Register Descriptions” on page 120 for details about which registers are subject to this timing restriction.

## 7.2.2 Clock Source

The Hibernation module must be clocked by an external source, even if the RTC feature will not be used. An external oscillator or crystal can be used for this purpose. To use a crystal, a 4.194304-MHz crystal is connected to the `XOSC0` and `XOSC1` pins. This clock signal is divided by 128 internally to produce the 32.768-kHz clock reference. To use a more precise clock source, a 32.768-kHz oscillator can be connected to the `XOSC0` pin.

The clock source is enabled by setting the `CLK32EN` bit of the **HIBCTL** register. The type of clock source is selected by setting the `CLKSEL` bit to 0 for a 4.194304-MHz clock source, and to 1 for a 32.768-kHz clock source. If the bit is set to 0, the input clock is divided by 128, resulting in a 32.768-kHz clock source. If a crystal is used for the clock source, the software must leave a delay of  $t_{XOSC\_SETTLE}$  after setting the `CLK32EN` bit and before any other accesses to the Hibernation module registers. The delay allows the crystal to power up and stabilize. If an oscillator is used for the clock source, no delay is needed.

## 7.2.3 Battery Management

The Hibernation module can be independently powered by a battery or an auxiliary power source. The module can monitor the voltage level of the battery and detect when the voltage becomes too low. When this happens, an interrupt can be generated. The module can also be configured so that it will not go into Hibernate mode if the battery voltage is too low.

Note that the Hibernation module draws power from whichever source (`VBAT` or `VDD`) has the higher voltage. Therefore, it is important to design the circuit to ensure that `VDD` is higher than `VBAT` under nominal conditions or else the Hibernation module draws power from the battery even when `VDD` is available.

The Hibernation module can be configured to detect a low battery condition by setting the `LOWBATEN` bit of the **HIBCTL** register. In this configuration, the `LOWBAT` bit of the **HIBRIS** register will be set when the battery level is low. If the `VABORT` bit is also set, then the module is prevented from entering Hibernation mode when a low battery is detected. The module can also be configured to generate an interrupt for the low-battery condition (see “Interrupts and Status” on page 117).

## 7.2.4 Real-Time Clock

The Hibernation module includes a 32-bit counter that increments once per second with a proper clock source and configuration (see “Clock Source” on page 116). The 32.768-kHz clock signal is fed into a predivider register which counts down the 32.768-kHz clock ticks to achieve a once per second clock rate for the RTC. The rate can be adjusted to compensate for inaccuracies in the clock source by using the predivider trim register. This register has a nominal value of `0x7FFF`, and is used for one second out of every 64 seconds to divide the input clock. This allows the software to make fine corrections to the clock rate by adjusting the predivider trim register up or down from `0x7FFF`. The predivider trim should be adjusted up from `0x7FFF` in order to slow down the RTC rate, and down from `0x7FFF` in order to speed up the RTC rate.

The Hibernation module includes two 32-bit match registers that are compared to the value of the RTC counter. The match registers can be used to wake the processor from hibernation mode, or to generate an interrupt to the processor if it is not in hibernation.

The RTC must be enabled with the `RTCEN` bit of the **HIBCTL** register. The value of the RTC can be set at any time by writing to the **HIBRTCLD** register. The predivider trim can be adjusted by reading and writing the **HIBRTCT** register. The predivider uses this register once every 64 seconds to adjust

the clock rate. The two match registers can be set by writing to the **HIBRTCM0** and **HIBRTCM1** registers. The RTC can be configured to generate interrupts by using the interrupt registers (see “Interrupts and Status” on page 117).

### 7.2.5 Non-Volatile Memory

The Hibernation module contains 64 32-bit words of memory which are retained during hibernation. This memory is powered from the battery or auxiliary power supply during hibernation. The processor software can save state information in this memory prior to hibernation, and can then recover the state upon waking. The non-volatile memory can be accessed through the **HIBDATA** registers.

### 7.2.6 Power Control

The Hibernation module controls power to the processor through the use of the  $\overline{\text{HIB}}$  pin, which is intended to be connected to the enable signal of the external regulator(s) providing 3.3 V and/or 2.5 V to the microcontroller. When the  $\overline{\text{HIB}}$  signal is asserted by the Hibernation module, the external regulator is turned off and no longer powers the microcontroller. The Hibernation module remains powered from the  $\text{VBAT}$  supply, which could be a battery or an auxiliary power source. Hibernation mode is initiated by the microcontroller setting the **HIBREQ** bit of the **HIBCTL** register. Prior to doing this, a wake-up condition must be configured, either from the external  $\overline{\text{WAKE}}$  pin, or by using an RTC match.

The Hibernation module is configured to wake from the external  $\overline{\text{WAKE}}$  pin by setting the **PINWEN** bit of the **HIBCTL** register. It is configured to wake from RTC match by setting the **RTCWEN** bit. Either one or both of these bits can be set prior to going into hibernation. The  $\overline{\text{WAKE}}$  pin includes a weak internal pull-up. Note that both the  $\overline{\text{HIB}}$  and  $\overline{\text{WAKE}}$  pins use the Hibernation module's internal power supply as the logic 1 reference.

When the Hibernation module wakes, the microcontroller will see a normal power-on reset. It can detect that the power-on was due to a wake from hibernation by examining the raw interrupt status register (see “Interrupts and Status” on page 117) and by looking for state data in the non-volatile memory (see “Non-Volatile Memory” on page 117).

When the  $\overline{\text{HIB}}$  signal deasserts, enabling the external regulator, the external regulator must reach the operating voltage within  $t_{\text{HIB\_TO\_VDD}}$ .

### 7.2.7 Interrupts and Status

The Hibernation module can generate interrupts when the following conditions occur:

- Assertion of  $\overline{\text{WAKE}}$  pin
- RTC match
- Low battery detected

All of the interrupts are ORed together before being sent to the interrupt controller, so the Hibernation module can only generate a single interrupt request to the controller at any given time. The software interrupt handler can service multiple interrupt events by reading the **HIBMIS** register. Software can also read the status of the Hibernation module at any time by reading the **HIBRIS** register which shows all of the pending events. This register can be used at power-on to see if a wake condition is pending, which indicates to the software that a hibernation wake occurred.

The events that can trigger an interrupt are configured by setting the appropriate bits in the **HIBIM** register. Pending interrupts can be cleared by writing the corresponding bit in the **HIBIC** register.

## 7.3 Initialization and Configuration

The Hibernation module can be configured in several different combinations. The following sections show the recommended programming sequence for various scenarios. The examples below assume that a 32.768-kHz oscillator is used, and thus always show bit 2 (`CLKSEL`) of the **HIBCTL** register set to 1. If a 4.194304-MHz crystal is used instead, then the `CLKSEL` bit remains cleared. Because the Hibernation module runs at 32 kHz and is asynchronous to the rest of the system, software must allow a delay of  $t_{\text{HIB\_REG\_WRITE}}$  after writes to certain registers (see “Register Access Timing” on page 115). The registers that require a delay are denoted with a footnote in Table 7-1 on page 119.

### 7.3.1 Initialization

The clock source must be enabled first, even if the RTC will not be used. If a 4.194304-MHz crystal is used, perform the following steps:

1. Write 0x40 to the **HIBCTL** register at offset 0x10 to enable the crystal and select the divide-by-128 input path.
2. Wait for a time of  $t_{\text{XOSC\_SETTLE}}$  for the crystal to power up and stabilize before performing any other operations with the Hibernation module.

If a 32.678-kHz oscillator is used, then perform the following steps:

1. Write 0x44 to the **HIBCTL** register at offset 0x10 to enable the oscillator input.
2. No delay is necessary.

The above is only necessary when the entire system is initialized for the first time. If the processor is powered due to a wake from hibernation, then the Hibernation module has already been powered up and the above steps are not necessary. The software can detect that the Hibernation module and clock are already powered by examining the `CLK32EN` bit of the **HIBCTL** register.

### 7.3.2 RTC Match Functionality (No Hibernation)

The following steps are needed to use the RTC match functionality of the Hibernation module:

1. Write the required RTC match value to one of the **HIBRTCMn** registers at offset 0x004 or 0x008.
2. Write the required RTC load value to the **HIBRTCLD** register at offset 0x00C.
3. Set the required RTC match interrupt mask in the `RTCALT0` and `RTCALT1` bits (bits 1:0) in the **HIBIM** register at offset 0x014.
4. Write 0x0000.0041 to the **HIBCTL** register at offset 0x010 to enable the RTC to begin counting.

### 7.3.3 RTC Match/Wake-Up from Hibernation

The following steps are needed to use the RTC match and wake-up functionality of the Hibernation module:

1. Write the required RTC match value to the **HIBRTCMn** registers at offset 0x004 or 0x008.
2. Write the required RTC load value to the **HIBRTCLD** register at offset 0x00C.
3. Write any data to be retained during power cut to the **HIBDATA** register at offsets 0x030-0x12C.

4. Set the RTC Match Wake-Up and start the hibernation sequence by writing 0x0000.004F to the **HIBCTL** register at offset 0x010.

### 7.3.4 External Wake-Up from Hibernation

The following steps are needed to use the Hibernation module with the external  $\overline{\text{WAKE}}$  pin as the wake-up source for the microcontroller:

1. Write any data to be retained during power cut to the **HIBDATA** register at offsets 0x030-0x12C.
2. Enable the external wake and start the hibernation sequence by writing 0x0000.0056 to the **HIBCTL** register at offset 0x010.

### 7.3.5 RTC/External Wake-Up from Hibernation

1. Write the required RTC match value to the **HIBRTCMn** registers at offset 0x004 or 0x008.
2. Write the required RTC load value to the **HIBRTCLD** register at offset 0x00C.
3. Write any data to be retained during power cut to the **HIBDATA** register at offsets 0x030-0x12C.
4. Set the RTC Match/External Wake-Up and start the hibernation sequence by writing 0x0000.005F to the **HIBCTL** register at offset 0x010.

## 7.4 Register Map

Table 7-1 on page 119 lists the Hibernation registers. All addresses given are relative to the Hibernation Module base address at 0x400F.C000.

**Note:** **HIBRTCC**, **HIBRTCM0**, **HIBRTCM1**, **HIBRTCLD**, **HIBRTCT**, and **HIBDATA** are on the Hibernation module clock domain and require a delay of  $t_{\text{HIB\_REG\_WRITE}}$  between write accesses. See “Register Access Timing” on page 115.

**Table 7-1. Hibernation Module Register Map**

Offset	Name	Type	Reset	Description	See page
0x000	HIBRTCC	RO	0x0000.0000	Hibernation RTC Counter	121
0x004	HIBRTCM0	R/W	0xFFFF.FFFF	Hibernation RTC Match 0	122
0x008	HIBRTCM1	R/W	0xFFFF.FFFF	Hibernation RTC Match 1	123
0x00C	HIBRTCLD	R/W	0xFFFF.FFFF	Hibernation RTC Load	124
0x010	HIBCTL	R/W	0x0000.0000	Hibernation Control	125
0x014	HIBIM	R/W	0x0000.0000	Hibernation Interrupt Mask	127
0x018	HIBRIS	RO	0x0000.0000	Hibernation Raw Interrupt Status	128
0x01C	HIBMIS	RO	0x0000.0000	Hibernation Masked Interrupt Status	129
0x020	HIBIC	R/W1C	0x0000.0000	Hibernation Interrupt Clear	130
0x024	HIBRTCT	R/W	0x0000.7FFF	Hibernation RTC Trim	131
0x030-0x12C	HIBDATA	R/W	0x0000.0000	Hibernation Data	132

## **7.5 Register Descriptions**

The remainder of this section lists and describes the Hibernation module registers, in numerical order by address offset.



## Register 1: Hibernation RTC Counter (HIBRTCC), offset 0x000

This register is the current 32-bit value of the RTC counter.

### Hibernation RTC Counter (HIBRTCC)

Base 0x400F.C000

Offset 0x000

Type RO, reset 0x0000.0000

	31	30	29	28	27	26	25	24	23	22	21	20	19	18	17	16
	RTCC															
Type	RO	RO	RO	RO	RO	RO	RO	RO	RO	RO	RO	RO	RO	RO	RO	RO
Reset	0	0	0	0	0	0	0	0	0	0	0	0	0	0	0	0
	15	14	13	12	11	10	9	8	7	6	5	4	3	2	1	0
	RTCC															
Type	RO	RO	RO	RO	RO	RO	RO	RO	RO	RO	RO	RO	RO	RO	RO	RO
Reset	0	0	0	0	0	0	0	0	0	0	0	0	0	0	0	0

Bit/Field	Name	Type	Reset	Description
31:0	RTCC	RO	0x0000.0000	RTC Counter

A read returns the 32-bit counter value. This register is read-only. To change the value, use the **HIBRTCLD** register.

## Register 2: Hibernation RTC Match 0 (HIBRTCM0), offset 0x004

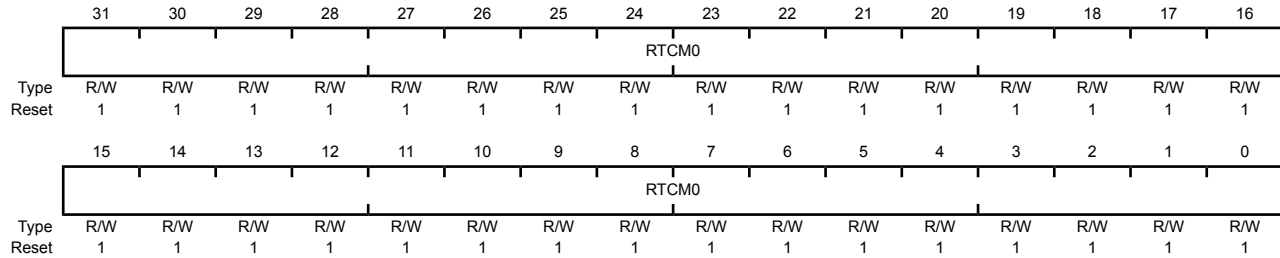
This register is the 32-bit match 0 register for the RTC counter.

### Hibernation RTC Match 0 (HIBRTCM0)

Base 0x400F.C000

Offset 0x004

Type R/W, reset 0xFFFF.FFFF



Bit/Field	Name	Type	Reset	Description
31:0	RTCM0	R/W	0xFFFF.FFFF	RTC Match 0

A write loads the value into the RTC match register.

A read returns the current match value.

### Register 3: Hibernation RTC Match 1 (HIBRTCM1), offset 0x008

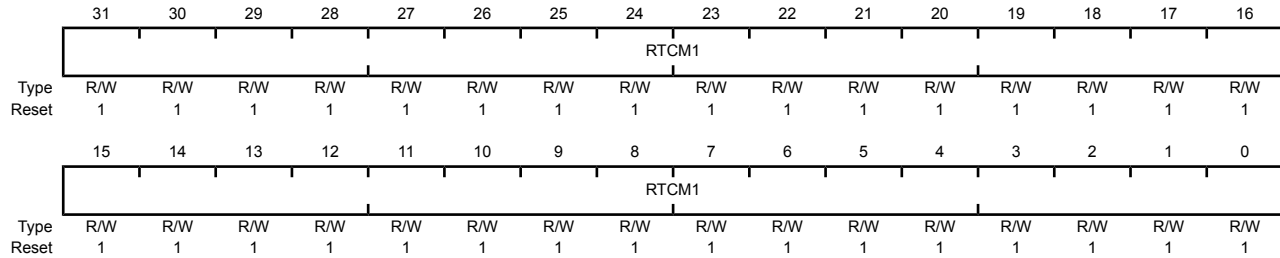
This register is the 32-bit match 1 register for the RTC counter.

#### Hibernation RTC Match 1 (HIBRTCM1)

Base 0x400F.C000

Offset 0x008

Type R/W, reset 0xFFFF.FFFF



Bit/Field	Name	Type	Reset	Description
31:0	RTCM1	R/W	0xFFFF.FFFF	RTC Match 1

A write loads the value into the RTC match register.

A read returns the current match value.

### Register 4: Hibernation RTC Load (HIBRTCLD), offset 0x00C

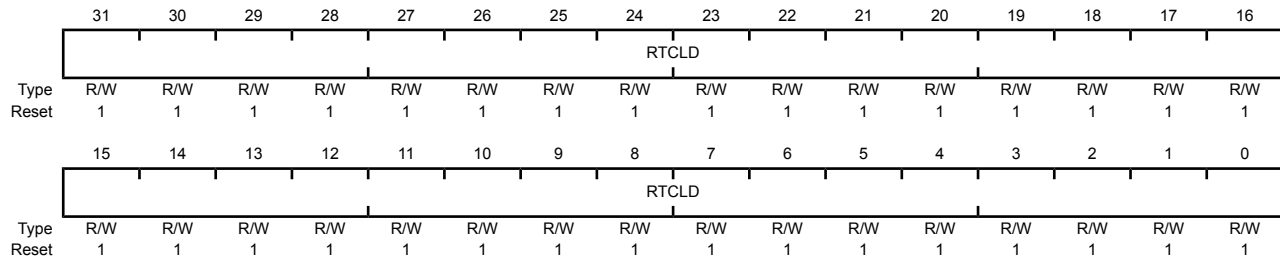
This register is the 32-bit value loaded into the RTC counter.

#### Hibernation RTC Load (HIBRTCLD)

Base 0x400F.C000

Offset 0x00C

Type R/W, reset 0xFFFF.FFFF



Bit/Field	Name	Type	Reset	Description
31:0	RTCLD	R/W	0xFFFF.FFFF	RTC Load

A write loads the current value into the RTC counter (RTCC).

A read returns the 32-bit load value.

## Register 5: Hibernation Control (HIBCTL), offset 0x010

This register is the control register for the Hibernation module.

### Hibernation Control (HIBCTL)

Base 0x400F.C000

Offset 0x010

Type R/W, reset 0x0000.0000

	31	30	29	28	27	26	25	24	23	22	21	20	19	18	17	16
	reserved															
Type	RO	RO	RO	RO	RO	RO	RO	RO	RO	RO	RO	RO	RO	RO	RO	RO
Reset	0	0	0	0	0	0	0	0	0	0	0	0	0	0	0	0
	15	14	13	12	11	10	9	8	7	6	5	4	3	2	1	0
	reserved								VABORT	CLK32EN	LOWBATEN	PINWEN	RTCWEN	CLKSEL	HIBREQ	RTCEN
Type	RO	RO	RO	RO	RO	RO	RO	RO	R/W	R/W	R/W	R/W	R/W	R/W	R/W	R/W
Reset	0	0	0	0	0	0	0	0	0	0	0	0	0	0	0	0

Bit/Field	Name	Type	Reset	Description
31:8	reserved	RO	0x00	Software should not rely on the value of a reserved bit. To provide compatibility with future products, the value of a reserved bit should be preserved across a read-modify-write operation.
7	VABORT	R/W	0	Power Cut Abort Enable 0: Power cut occurs during a low-battery alert 1: Power cut is aborted
6	CLK32EN	R/W	0	32-kHz Oscillator Enable 0: Disabled 1: Enabled  This bit must be enabled to use the Hibernation module. If a crystal is used, then software should wait 20 ms after setting this bit to allow the crystal to power up and stabilize.
5	LOWBATEN	R/W	0	Low Battery Monitoring Enable 0: Disabled 1: Enabled  When set, low battery voltage detection is enabled.
4	PINWEN	R/W	0	External $\overline{\text{WAKE}}$ Pin Enable 0: Disabled 1: Enabled  When set, an external event on the $\overline{\text{WAKE}}$ pin will re-power the device.
3	RTCWEN	R/W	0	RTC Wake-up Enable 0: Disabled 1: Enabled  When set, an RTC match event ( $\text{RTC}_0$ or $\text{RTC}_1$ ) will re-power the device based on the RTC counter value matching the corresponding match register 0 or 1.

Bit/Field	Name	Type	Reset	Description
2	CLKSEL	R/W	0	Hibernation Module Clock Select 0: Use Divide by 128 output. Use this value for a 4-MHz crystal. 1: Use raw output. Use this value for a 32-kHz oscillator.
1	HIBREQ	R/W	0	Hibernation Request 0: Disabled 1: Hibernation initiated After a wake-up event, this bit is cleared by hardware.
0	RTCEN	R/W	0	RTC Timer Enable 0: Disabled 1: Enabled

## Register 6: Hibernation Interrupt Mask (HIBIM), offset 0x014

This register is the interrupt mask register for the Hibernation module interrupt sources.

### Hibernation Interrupt Mask (HIBIM)

Base 0x400F.C000

Offset 0x014

Type R/W, reset 0x0000.0000

	31	30	29	28	27	26	25	24	23	22	21	20	19	18	17	16
	reserved															
Type	RO	RO	RO	RO	RO	RO	RO	RO	RO	RO	RO	RO	RO	RO	RO	RO
Reset	0	0	0	0	0	0	0	0	0	0	0	0	0	0	0	0
	15	14	13	12	11	10	9	8	7	6	5	4	3	2	1	0
	reserved												EXTW	LOWBAT	RTCALT1	RTCALT0
Type	RO	RO	RO	RO	RO	RO	RO	RO	RO	RO	RO	RO	R/W	R/W	R/W	R/W
Reset	0	0	0	0	0	0	0	0	0	0	0	0	0	0	0	0

Bit/Field	Name	Type	Reset	Description
31:4	reserved	RO	0x000.0000	Software should not rely on the value of a reserved bit. To provide compatibility with future products, the value of a reserved bit should be preserved across a read-modify-write operation.
3	EXTW	R/W	0	External Wake-Up Interrupt Mask 0: Masked 1: Unmasked
2	LOWBAT	R/W	0	Low Battery Voltage Interrupt Mask 0: Masked 1: Unmasked
1	RTCALT1	R/W	0	RTC Alert1 Interrupt Mask 0: Masked 1: Unmasked
0	RTCALT0	R/W	0	RTC Alert0 Interrupt Mask 0: Masked 1: Unmasked

### Register 7: Hibernation Raw Interrupt Status (HIBRIS), offset 0x018

This register is the raw interrupt status for the Hibernation module interrupt sources.

#### Hibernation Raw Interrupt Status (HIBRIS)

Base 0x400F.C000

Offset 0x018

Type RO, reset 0x0000.0000

	31	30	29	28	27	26	25	24	23	22	21	20	19	18	17	16
	reserved															
Type	RO	RO	RO	RO	RO	RO	RO	RO	RO	RO	RO	RO	RO	RO	RO	RO
Reset	0	0	0	0	0	0	0	0	0	0	0	0	0	0	0	0
	15	14	13	12	11	10	9	8	7	6	5	4	3	2	1	0
	reserved												EXTW	LOWBAT	RTCALT1	RTCALT0
Type	RO	RO	RO	RO	RO	RO	RO	RO	RO	RO	RO	RO	RO	RO	RO	RO
Reset	0	0	0	0	0	0	0	0	0	0	0	0	0	0	0	0

Bit/Field	Name	Type	Reset	Description
31:4	reserved	RO	0x000.0000	Software should not rely on the value of a reserved bit. To provide compatibility with future products, the value of a reserved bit should be preserved across a read-modify-write operation.
3	EXTW	RO	0	External Wake-Up Raw Interrupt Status
2	LOWBAT	RO	0	Low Battery Voltage Raw Interrupt Status
1	RTCALT1	RO	0	RTC Alert1 Raw Interrupt Status
0	RTCALT0	RO	0	RTC Alert0 Raw Interrupt Status



## Register 8: Hibernation Masked Interrupt Status (HIBMIS), offset 0x01C

This register is the masked interrupt status for the Hibernation module interrupt sources.

### Hibernation Masked Interrupt Status (HIBMIS)

Base 0x400F.C000

Offset 0x01C

Type RO, reset 0x0000.0000

	31	30	29	28	27	26	25	24	23	22	21	20	19	18	17	16	
	reserved																
Type	RO	RO	RO	RO	RO	RO	RO	RO	RO	RO	RO	RO	RO	RO	RO	RO	
Reset	0	0	0	0	0	0	0	0	0	0	0	0	0	0	0	0	
	15	14	13	12	11	10	9	8	7	6	5	4	3	2	1	0	
	reserved													EXTW	LOWBAT	RTCALT1	RTCALT0
Type	RO	RO	RO	RO	RO	RO	RO	RO	RO	RO	RO	RO	RO	RO	RO	RO	
Reset	0	0	0	0	0	0	0	0	0	0	0	0	0	0	0	0	

Bit/Field	Name	Type	Reset	Description
31:4	reserved	RO	0x000.0000	Software should not rely on the value of a reserved bit. To provide compatibility with future products, the value of a reserved bit should be preserved across a read-modify-write operation.
3	EXTW	RO	0	External Wake-Up Masked Interrupt Status
2	LOWBAT	RO	0	Low Battery Voltage Masked Interrupt Status
1	RTCALT1	RO	0	RTC Alert1 Masked Interrupt Status
0	RTCALT0	RO	0	RTC Alert0 Masked Interrupt Status

### Register 9: Hibernation Interrupt Clear (HIBIC), offset 0x020

This register is the interrupt write-one-to-clear register for the Hibernation module interrupt sources.

#### Hibernation Interrupt Clear (HIBIC)

Base 0x400F.C000

Offset 0x020

Type R/W1C, reset 0x0000.0000

	31	30	29	28	27	26	25	24	23	22	21	20	19	18	17	16
	reserved															
Type	RO	RO	RO	RO	RO	RO	RO	RO	RO	RO	RO	RO	RO	RO	RO	RO
Reset	0	0	0	0	0	0	0	0	0	0	0	0	0	0	0	0
	15	14	13	12	11	10	9	8	7	6	5	4	3	2	1	0
	reserved												EXTW	LOWBAT	RTCALT1	RTCALT0
Type	RO	RO	RO	RO	RO	RO	RO	RO	RO	RO	RO	RO	R/W1C	R/W1C	R/W1C	R/W1C
Reset	0	0	0	0	0	0	0	0	0	0	0	0	0	0	0	0

Bit/Field	Name	Type	Reset	Description
31:4	reserved	RO	0x000.0000	Software should not rely on the value of a reserved bit. To provide compatibility with future products, the value of a reserved bit should be preserved across a read-modify-write operation.
3	EXTW	R/W1C	0	External Wake-Up Masked Interrupt Clear Reads return an indeterminate value.
2	LOWBAT	R/W1C	0	Low Battery Voltage Masked Interrupt Clear Reads return an indeterminate value.
1	RTCALT1	R/W1C	0	RTC Alert1 Masked Interrupt Clear Reads return an indeterminate value.
0	RTCALT0	R/W1C	0	RTC Alert0 Masked Interrupt Clear Reads return an indeterminate value.

## Register 10: Hibernation RTC Trim (HIBRTCT), offset 0x024

This register contains the value that is used to trim the RTC clock predivider. It represents the computed underflow value that is used during the trim cycle. It is represented as  $0x7FFF \pm N$  clock cycles.

### Hibernation RTC Trim (HIBRTCT)

Base 0x400F.C000

Offset 0x024

Type R/W, reset 0x0000.7FFF

	31	30	29	28	27	26	25	24	23	22	21	20	19	18	17	16
	reserved															
Type	RO	RO	RO	RO	RO	RO	RO	RO	RO	RO	RO	RO	RO	RO	RO	RO
Reset	0	0	0	0	0	0	0	0	0	0	0	0	0	0	0	0
	15	14	13	12	11	10	9	8	7	6	5	4	3	2	1	0
	TRIM															
Type	R/W	R/W	R/W	R/W	R/W	R/W	R/W	R/W	R/W	R/W	R/W	R/W	R/W	R/W	R/W	R/W
Reset	0	1	1	1	1	1	1	1	1	1	1	1	1	1	1	1

Bit/Field	Name	Type	Reset	Description
31:16	reserved	RO	0x0000	Software should not rely on the value of a reserved bit. To provide compatibility with future products, the value of a reserved bit should be preserved across a read-modify-write operation.
15:0	TRIM	R/W	0x7FFF	RTC Trim Value

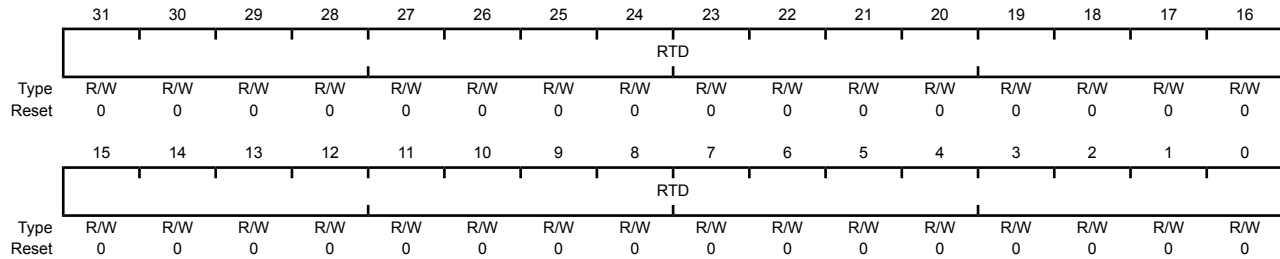
This value is loaded into the RTC predivider every 64 seconds. It is used to adjust the RTC rate to account for drift and inaccuracy in the clock source. The compensation is made by software by adjusting the default value of 0x7FFF up or down.

**Register 11: Hibernation Data (HIBDATA), offset 0x030-0x12C**

This address space is implemented as a 64x32-bit memory (256 bytes). It can be loaded by the system processor in order to store any non-volatile state data and will not lose power during a power cut operation.

Hibernation Data (HIBDATA)

Base 0x400F.C000  
 Offset 0x030-0x12C  
 Type R/W, reset 0x0000.0000



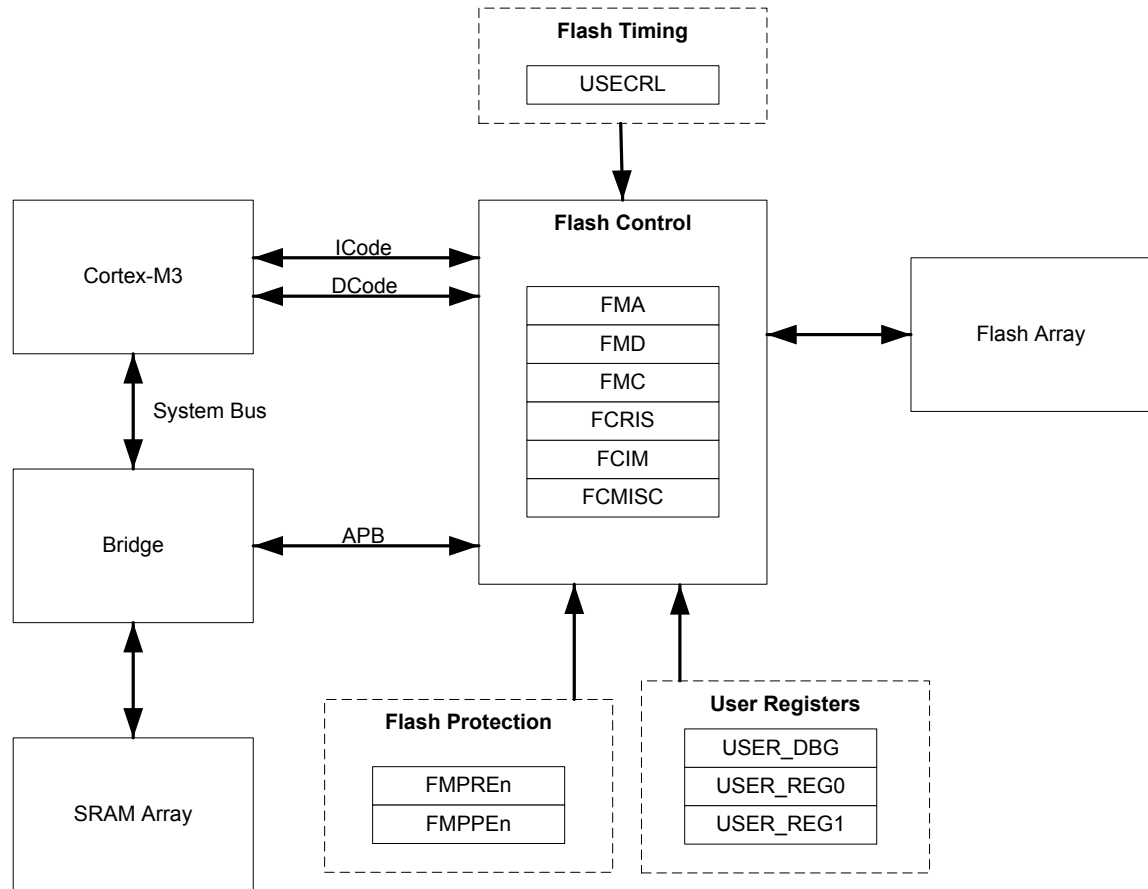
Bit/Field	Name	Type	Reset	Description
31:0	RTD	R/W	0x0000.0000	Hibernation Module NV Registers[63:0]

## 8 Internal Memory

The LM3S1138 microcontroller comes with 16 KB of bit-banded SRAM and 64 KB of flash memory. The flash controller provides a user-friendly interface, making flash programming a simple task. Flash protection can be applied to the flash memory on a 2-KB block basis.

### 8.1 Block Diagram

Figure 8-1. Flash Block Diagram



### 8.2 Functional Description

This section describes the functionality of both the flash and SRAM memories.

#### 8.2.1 SRAM Memory

The internal SRAM of the Stellaris® devices is located at address 0x2000.0000 of the device memory map. To reduce the number of time consuming read-modify-write (RMW) operations, ARM has introduced *bit-banding* technology in the Cortex-M3 processor. With a bit-band-enabled processor, certain regions in the memory map (SRAM and peripheral space) can use address aliases to access individual bits in a single, atomic operation.

The bit-band alias is calculated by using the formula:

$\text{bit-band alias} = \text{bit-band base} + (\text{byte offset} * 32) + (\text{bit number} * 4)$

For example, if bit 3 at address 0x2000.1000 is to be modified, the bit-band alias is calculated as:

$0x2200.0000 + (0x1000 * 32) + (3 * 4) = 0x2202.000C$

With the alias address calculated, an instruction performing a read/write to address 0x2202.000C allows direct access to only bit 3 of the byte at address 0x2000.1000.

For details about bit-banding, please refer to Chapter 4, “Memory Map” in the *ARM® Cortex™-M3 Technical Reference Manual*.

## 8.2.2 Flash Memory

The flash is organized as a set of 1-KB blocks that can be individually erased. Erasing a block causes the entire contents of the block to be reset to all 1s. An individual 32-bit word can be programmed to change bits that are currently 1 to a 0. These blocks are paired into a set of 2-KB blocks that can be individually protected. The protection allows blocks to be marked as read-only or execute-only, providing different levels of code protection. Read-only blocks cannot be erased or programmed, protecting the contents of those blocks from being modified. Execute-only blocks cannot be erased or programmed, and can only be read by the controller instruction fetch mechanism, protecting the contents of those blocks from being read by either the controller or by a debugger.

See also “Serial Flash Loader” on page 445 for a preprogrammed flash-resident utility used to download code to the flash memory of a device without the use of a debug interface.

### 8.2.2.1 Flash Memory Timing

The timing for the flash is automatically handled by the flash controller. However, in order to do so, it must know the clock rate of the system in order to time its internal signals properly. The number of clock cycles per microsecond must be provided to the flash controller for it to accomplish this timing. It is software's responsibility to keep the flash controller updated with this information via the **Usec Reload (USECRL)** register.

On reset, the **USECRL** register is loaded with a value that configures the flash timing so that it works with the maximum clock rate of the part. If software changes the system operating frequency, the new operating frequency minus 1 (in MHz) must be loaded into **USECRL** before any flash modifications are attempted. For example, if the device is operating at a speed of 20 MHz, a value of 0x13 (20-1) must be written to the **USECRL** register.

### 8.2.2.2 Flash Memory Protection

The user is provided two forms of flash protection per 2-KB flash blocks in one pair of 32-bit wide registers. The protection policy for each form is controlled by individual bits (per policy per block) in the **FMPPEn** and **FMPREn** registers.

- **Flash Memory Protection Program Enable (FMPPEn)**: If set, the block may be programmed (written) or erased. If cleared, the block may not be changed.
- **Flash Memory Protection Read Enable (FMPREn)**: If set, the block may be executed or read by software or debuggers. If cleared, the block may only be executed. The contents of the memory block are prohibited from being accessed as data and traversing the DCode bus.

The policies may be combined as shown in Table 8-1 on page 135.

**Table 8-1. Flash Protection Policy Combinations**

FMPPEn	FMPREn	Protection
0	0	Execute-only protection. The block may only be executed and may not be written or erased. This mode is used to protect code.
1	0	The block may be written, erased or executed, but not read. This combination is unlikely to be used.
0	1	Read-only protection. The block may be read or executed but may not be written or erased. This mode is used to lock the block from further modification while allowing any read or execute access.
1	1	No protection. The block may be written, erased, executed or read.

An access that attempts to program or erase a PE-protected block is prohibited. A controller interrupt may be optionally generated (by setting the `AMASK` bit in the **FIM** register) to alert software developers of poorly behaving software during the development and debug phases.

An access that attempts to read an RE-protected block is prohibited. Such accesses return data filled with all 0s. A controller interrupt may be optionally generated to alert software developers of poorly behaving software during the development and debug phases.

The factory settings for the **FMPREn** and **FMPPEn** registers are a value of 1 for all implemented banks. This implements a policy of open access and programmability. The register bits may be changed by writing the specific register bit. The changes are not permanent until the register is committed (saved), at which point the bit change is permanent. If a bit is changed from a 1 to a 0 and not committed, it may be restored by executing a power-on reset sequence. Details on programming these bits are discussed in “Nonvolatile Register Programming” on page 136.

## 8.3 Flash Memory Initialization and Configuration

### 8.3.1 Flash Programming

The Stellaris<sup>®</sup> devices provide a user-friendly interface for flash programming. All erase/program operations are handled via three registers: **FMA**, **FMD**, and **FMC**.

#### 8.3.1.1 To program a 32-bit word

1. Write source data to the **FMD** register.
2. Write the target address to the **FMA** register.
3. Write the flash write key and the `WRITE` bit (a value of 0xA442.0001) to the **FMC** register.
4. Poll the **FMC** register until the `WRITE` bit is cleared.

#### 8.3.1.2 To perform an erase of a 1-KB page

1. Write the page address to the **FMA** register.
2. Write the flash write key and the `ERASE` bit (a value of 0xA442.0002) to the **FMC** register.
3. Poll the **FMC** register until the `ERASE` bit is cleared.

#### 8.3.1.3 To perform a mass erase of the flash

1. Write the flash write key and the `MERASE` bit (a value of 0xA442.0004) to the **FMC** register.
2. Poll the **FMC** register until the `MERASE` bit is cleared.

### 8.3.2 Nonvolatile Register Programming

This section discusses how to update registers that are resident within the flash memory itself. These registers exist in a separate space from the main flash array and are not affected by an ERASE or MASS ERASE operation. These nonvolatile registers are updated by using the `COMT` bit in the **FMC** register to activate a write operation. For the **USER\_DBG** register, the data to be written must be loaded into the **FMD** register before it is "committed". All other registers are R/W and can have their operation tried before committing them to nonvolatile memory.

**Important:** These registers can only have bits changed from 1 to 0 by the user and there is no mechanism for the user to erase them back to a 1 value.

In addition, the **USER\_REG0**, **USER\_REG1**, and **USER\_DBG** use bit 31 ( $NW$ ) of their respective registers to indicate that they are available for user write. These three registers can only be written once whereas the flash protection registers may be written multiple times. Table 8-2 on page 136 provides the FMA address required for commitment of each of the registers and the source of the data to be written when the `COMT` bit of the **FMC** register is written with a value of 0xA442.0008. After writing the `COMT` bit, the user may poll the **FMC** register to wait for the commit operation to complete.

**Table 8-2. Flash Resident Registers<sup>a</sup>**

Register to be Committed	FMA Value	Data Source
FMPRE0	0x0000.0000	FMPRE0
FMPRE1	0x0000.0002	FMPRE1
FMPRE2	0x0000.0004	FMPRE2
FMPRE3	0x0000.0008	FMPRE3
FMPPE0	0x0000.0001	FMPPE0
FMPPE1	0x0000.0003	FMPPE1
FMPPE2	0x0000.0005	FMPPE2
FMPPE3	0x0000.0007	FMPPE3
USER_REG0	0x8000.0000	USER_REG0
USER_REG1	0x8000.0001	USER_REG1
USER_DBG	0x7510.0000	FMD

a. Which FMPREn and FMPPEn registers are available depend on the flash size of your particular Stellaris<sup>®</sup> device.

## 8.4 Register Map

Table 8-3 on page 136 lists the Flash memory and control registers. The offset listed is a hexadecimal increment to the register's address. The **FMA**, **FMD**, **FMC**, **FCRIS**, **FCIM**, and **FCMISC** registers are relative to the Flash control base address of 0x400F.D000. The **FMPREn**, **FMPPEn**, **USECRL**, **USER\_DBG**, and **USER\_REGn** registers are relative to the System Control base address of 0x400F.E000.

**Table 8-3. Flash Register Map**

Offset	Name	Type	Reset	Description	See page
<b>Flash Control Offset</b>					
0x000	FMA	R/W	0x0000.0000	Flash Memory Address	138



Offset	Name	Type	Reset	Description	See page
0x004	FMD	R/W	0x0000.0000	Flash Memory Data	139
0x008	FMC	R/W	0x0000.0000	Flash Memory Control	140
0x00C	FCRIS	RO	0x0000.0000	Flash Controller Raw Interrupt Status	142
0x010	FCIM	R/W	0x0000.0000	Flash Controller Interrupt Mask	143
0x014	FCMISC	R/W1C	0x0000.0000	Flash Controller Masked Interrupt Status and Clear	144
<b>System Control Offset</b>					
0x130	FMPRE0	R/W	0xFFFF.FFFF	Flash Memory Protection Read Enable 0	146
0x200	FMPRE0	R/W	0xFFFF.FFFF	Flash Memory Protection Read Enable 0	146
0x134	FMPPE0	R/W	0xFFFF.FFFF	Flash Memory Protection Program Enable 0	147
0x400	FMPPE0	R/W	0xFFFF.FFFF	Flash Memory Protection Program Enable 0	147
0x140	USECRL	R/W	0x31	USec Reload	145
0x1D0	USER_DBG	R/W	0xFFFF.FFFE	User Debug	148
0x1E0	USER_REG0	R/W	0xFFFF.FFFF	User Register 0	149
0x1E4	USER_REG1	R/W	0xFFFF.FFFF	User Register 1	150
0x204	FMPRE1	R/W	0x0000.0000	Flash Memory Protection Read Enable 1	151
0x208	FMPRE2	R/W	0x0000.0000	Flash Memory Protection Read Enable 2	152
0x20C	FMPRE3	R/W	0x0000.0000	Flash Memory Protection Read Enable 3	153
0x404	FMPPE1	R/W	0x0000.0000	Flash Memory Protection Program Enable 1	154
0x408	FMPPE2	R/W	0x0000.0000	Flash Memory Protection Program Enable 2	155
0x40C	FMPPE3	R/W	0x0000.0000	Flash Memory Protection Program Enable 3	156

## 8.5 Flash Register Descriptions (Flash Control Offset)

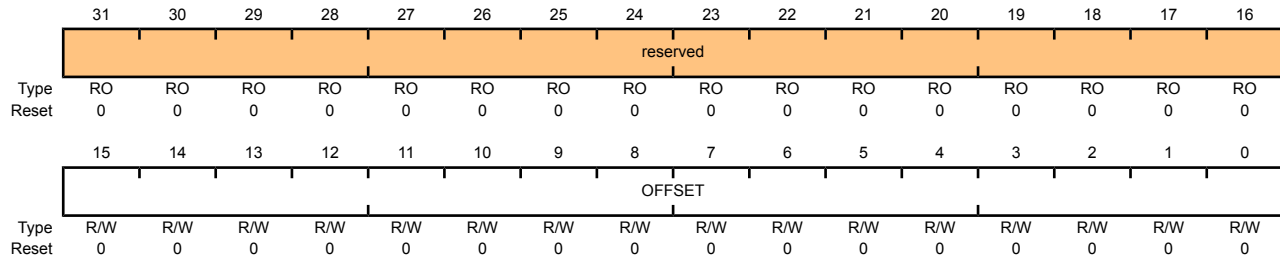
The remainder of this section lists and describes the Flash Memory registers, in numerical order by address offset. Registers in this section are relative to the Flash control base address of 0x400F.D000.

### Register 1: Flash Memory Address (FMA), offset 0x000

During a write operation, this register contains a 4-byte-aligned address and specifies where the data is written. During erase operations, this register contains a 1 KB-aligned address and specifies which page is erased. Note that the alignment requirements must be met by software or the results of the operation are unpredictable.

#### Flash Memory Address (FMA)

Base 0x400F.D000  
 Offset 0x000  
 Type R/W, reset 0x0000.0000



Bit/Field	Name	Type	Reset	Description
31:16	reserved	RO	0x0	Software should not rely on the value of a reserved bit. To provide compatibility with future products, the value of a reserved bit should be preserved across a read-modify-write operation.
15:0	OFFSET	R/W	0x0	Address Offset  Address offset in flash where operation is performed, except for nonvolatile registers (see "Nonvolatile Register Programming" on page 136 for details on values for this field).

## Register 2: Flash Memory Data (FMD), offset 0x004

This register contains the data to be written during the programming cycle or read during the read cycle. Note that the contents of this register are undefined for a read access of an execute-only block. This register is not used during the erase cycles.

### Flash Memory Data (FMD)

Base 0x400F.D000

Offset 0x004

Type R/W, reset 0x0000.0000

	31	30	29	28	27	26	25	24	23	22	21	20	19	18	17	16
	DATA															
Type	R/W	R/W	R/W	R/W	R/W	R/W	R/W	R/W	R/W	R/W	R/W	R/W	R/W	R/W	R/W	R/W
Reset	0	0	0	0	0	0	0	0	0	0	0	0	0	0	0	0
	15	14	13	12	11	10	9	8	7	6	5	4	3	2	1	0
	DATA															
Type	R/W	R/W	R/W	R/W	R/W	R/W	R/W	R/W	R/W	R/W	R/W	R/W	R/W	R/W	R/W	R/W
Reset	0	0	0	0	0	0	0	0	0	0	0	0	0	0	0	0

Bit/Field	Name	Type	Reset	Description
31:0	DATA	R/W	0x0	Data Value Data value for write operation.

### Register 3: Flash Memory Control (FMC), offset 0x008

When this register is written, the flash controller initiates the appropriate access cycle for the location specified by the **Flash Memory Address (FMA)** register (see page 138). If the access is a write access, the data contained in the **Flash Memory Data (FMD)** register (see page 139) is written.

This is the final register written and initiates the memory operation. There are four control bits in the lower byte of this register that, when set, initiate the memory operation. The most used of these register bits are the `ERASE` and `WRITE` bits.

It is a programming error to write multiple control bits and the results of such an operation are unpredictable.

#### Flash Memory Control (FMC)

Base 0x400F.D000

Offset 0x008

Type R/W, reset 0x0000.0000

	31	30	29	28	27	26	25	24	23	22	21	20	19	18	17	16
	WRKEY															
Type	WO	WO	WO	WO	WO	WO	WO	WO	WO	WO	WO	WO	WO	WO	WO	WO
Reset	0	0	0	0	0	0	0	0	0	0	0	0	0	0	0	0
	15	14	13	12	11	10	9	8	7	6	5	4	3	2	1	0
	reserved												COMT	MERASE	ERASE	WRITE
Type	RO	RO	RO	RO	RO	RO	RO	RO	RO	RO	RO	RO	R/W	R/W	R/W	R/W
Reset	0	0	0	0	0	0	0	0	0	0	0	0	0	0	0	0

Bit/Field	Name	Type	Reset	Description
31:16	WRKEY	WO	0x0	Flash Write Key  This field contains a write key, which is used to minimize the incidence of accidental flash writes. The value 0xA442 must be written into this field for a write to occur. Writes to the <b>FMC</b> register without this <code>WRKEY</code> value are ignored. A read of this field returns the value 0.
15:4	reserved	RO	0x0	Software should not rely on the value of a reserved bit. To provide compatibility with future products, the value of a reserved bit should be preserved across a read-modify-write operation.
3	COMT	R/W	0	Commit Register Value  Commit (write) of register value to nonvolatile storage. A write of 0 has no effect on the state of this bit.  If read, the state of the previous commit access is provided. If the previous commit access is complete, a 0 is returned; otherwise, if the commit access is not complete, a 1 is returned.  This can take up to 50 $\mu$ s.
2	MERASE	R/W	0	Mass Erase Flash Memory  If this bit is set, the flash main memory of the device is all erased. A write of 0 has no effect on the state of this bit.  If read, the state of the previous mass erase access is provided. If the previous mass erase access is complete, a 0 is returned; otherwise, if the previous mass erase access is not complete, a 1 is returned.  This can take up to 250 ms.

---

Bit/Field	Name	Type	Reset	Description
1	ERASE	R/W	0	<p>Erase a Page of Flash Memory</p> <p>If this bit is set, the page of flash main memory as specified by the contents of <b>FMA</b> is erased. A write of 0 has no effect on the state of this bit.</p> <p>If read, the state of the previous erase access is provided. If the previous erase access is complete, a 0 is returned; otherwise, if the previous erase access is not complete, a 1 is returned.</p> <p>This can take up to 25 ms.</p>
0	WRITE	R/W	0	<p>Write a Word into Flash Memory</p> <p>If this bit is set, the data stored in <b>FMD</b> is written into the location as specified by the contents of <b>FMA</b>. A write of 0 has no effect on the state of this bit.</p> <p>If read, the state of the previous write update is provided. If the previous write access is complete, a 0 is returned; otherwise, if the write access is not complete, a 1 is returned.</p> <p>This can take up to 50 <math>\mu</math>s.</p>

## Register 4: Flash Controller Raw Interrupt Status (FCRIS), offset 0x00C

This register indicates that the flash controller has an interrupt condition. An interrupt is only signaled if the corresponding **FCIM** register bit is set.

### Flash Controller Raw Interrupt Status (FCRIS)

Base 0x400F.D000

Offset 0x00C

Type RO, reset 0x0000.0000

	31	30	29	28	27	26	25	24	23	22	21	20	19	18	17	16
	reserved															
Type	RO	RO	RO	RO	RO	RO	RO	RO	RO	RO	RO	RO	RO	RO	RO	RO
Reset	0	0	0	0	0	0	0	0	0	0	0	0	0	0	0	0
	15	14	13	12	11	10	9	8	7	6	5	4	3	2	1	0
	reserved														PRIS	ARIS
Type	RO	RO	RO	RO	RO	RO	RO	RO	RO	RO	RO	RO	RO	RO	RO	RO
Reset	0	0	0	0	0	0	0	0	0	0	0	0	0	0	0	0

Bit/Field	Name	Type	Reset	Description
31:2	reserved	RO	0x00	Software should not rely on the value of a reserved bit. To provide compatibility with future products, the value of a reserved bit should be preserved across a read-modify-write operation.
1	PRIS	RO	0	<p>Programming Raw Interrupt Status</p> <p>This bit indicates the current state of the programming cycle. If set, the programming cycle completed; if cleared, the programming cycle has not completed. Programming cycles are either write or erase actions generated through the <b>Flash Memory Control (FMC)</b> register bits (see page 140).</p>
0	ARIS	RO	0	<p>Access Raw Interrupt Status</p> <p>This bit indicates if the flash was improperly accessed. If set, the program tried to access the flash counter to the policy as set in the <b>Flash Memory Protection Read Enable (FMPREn)</b> and <b>Flash Memory Protection Program Enable (FMPPEn)</b> registers. Otherwise, no access has tried to improperly access the flash.</p>

## Register 5: Flash Controller Interrupt Mask (FCIM), offset 0x010

This register controls whether the flash controller generates interrupts to the controller.

### Flash Controller Interrupt Mask (FCIM)

Base 0x400F.D000

Offset 0x010

Type R/W, reset 0x0000.0000

	31	30	29	28	27	26	25	24	23	22	21	20	19	18	17	16	
	reserved																
Type	RO	RO	RO	RO	RO	RO	RO	RO	RO	RO	RO	RO	RO	RO	RO	RO	
Reset	0	0	0	0	0	0	0	0	0	0	0	0	0	0	0	0	
	15	14	13	12	11	10	9	8	7	6	5	4	3	2	1	0	
	reserved														PMASK	AMASK	
Type	RO	RO	RO	RO	RO	RO	RO	RO	RO	RO	RO	RO	RO	RO	RO	R/W	R/W
Reset	0	0	0	0	0	0	0	0	0	0	0	0	0	0	0	0	0

Bit/Field	Name	Type	Reset	Description
31:2	reserved	RO	0x00	Software should not rely on the value of a reserved bit. To provide compatibility with future products, the value of a reserved bit should be preserved across a read-modify-write operation.
1	PMASK	R/W	0	<p>Programming Interrupt Mask</p> <p>This bit controls the reporting of the programming raw interrupt status to the controller. If set, a programming-generated interrupt is promoted to the controller. Otherwise, interrupts are recorded but suppressed from the controller.</p>
0	AMASK	R/W	0	<p>Access Interrupt Mask</p> <p>This bit controls the reporting of the access raw interrupt status to the controller. If set, an access-generated interrupt is promoted to the controller. Otherwise, interrupts are recorded but suppressed from the controller.</p>

## Register 6: Flash Controller Masked Interrupt Status and Clear (FCMISC), offset 0x014

This register provides two functions. First, it reports the cause of an interrupt by indicating which interrupt source or sources are signalling the interrupt. Second, it serves as the method to clear the interrupt reporting.

### Flash Controller Masked Interrupt Status and Clear (FCMISC)

Base 0x400F.D000

Offset 0x014

Type R/W1C, reset 0x0000.0000

	31	30	29	28	27	26	25	24	23	22	21	20	19	18	17	16
	reserved															
Type	RO	RO	RO	RO	RO	RO	RO	RO	RO	RO	RO	RO	RO	RO	RO	RO
Reset	0	0	0	0	0	0	0	0	0	0	0	0	0	0	0	0
	15	14	13	12	11	10	9	8	7	6	5	4	3	2	1	0
	reserved														PMISC	AMISC
Type	RO	RO	RO	RO	RO	RO	RO	RO	RO	RO	RO	RO	RO	RO	R/W1C	R/W1C
Reset	0	0	0	0	0	0	0	0	0	0	0	0	0	0	0	0

Bit/Field	Name	Type	Reset	Description
31:2	reserved	RO	0x00	Software should not rely on the value of a reserved bit. To provide compatibility with future products, the value of a reserved bit should be preserved across a read-modify-write operation.
1	PMISC	R/W1C	0	Programming Masked Interrupt Status and Clear  This bit indicates whether an interrupt was signaled because a programming cycle completed and was not masked. This bit is cleared by writing a 1. The <code>PRIS</code> bit in the <code>FCRIS</code> register (see page 142) is also cleared when the <code>PMISC</code> bit is cleared.
0	AMISC	R/W1C	0	Access Masked Interrupt Status and Clear  This bit indicates whether an interrupt was signaled because an improper access was attempted and was not masked. This bit is cleared by writing a 1. The <code>ARIS</code> bit in the <code>FCRIS</code> register is also cleared when the <code>AMISC</code> bit is cleared.

## 8.6 Flash Register Descriptions (System Control Offset)

The remainder of this section lists and describes the Flash Memory registers, in numerical order by address offset. Registers in this section are relative to the System Control base address of 0x400F.E000.



**Register 7: USec Reload (USECRL), offset 0x140**

**Note:** Offset is relative to System Control base address of 0x400F.E000

This register is provided as a means of creating a 1- $\mu$ s tick divider reload value for the flash controller. The internal flash has specific minimum and maximum requirements on the length of time the high voltage write pulse can be applied. It is required that this register contain the operating frequency (in MHz -1) whenever the flash is being erased or programmed. The user is required to change this value if the clocking conditions are changed for a flash erase/program operation.

## USec Reload (USECRL)

Base 0x400F.E000

Offset 0x140

Type R/W, reset 0x31

	31	30	29	28	27	26	25	24	23	22	21	20	19	18	17	16
	reserved															
Type	RO	RO	RO	RO	RO	RO	RO	RO	RO	RO	RO	RO	RO	RO	RO	RO
Reset	0	0	0	0	0	0	0	0	0	0	0	0	0	0	0	0
	15	14	13	12	11	10	9	8	7	6	5	4	3	2	1	0
	reserved								USEC							
Type	RO	RO	RO	RO	RO	RO	RO	RO	R/W	R/W	R/W	R/W	R/W	R/W	R/W	R/W
Reset	0	0	0	0	0	0	0	0	0	0	1	1	0	0	0	1

Bit/Field	Name	Type	Reset	Description
31:8	reserved	RO	0x00	Software should not rely on the value of a reserved bit. To provide compatibility with future products, the value of a reserved bit should be preserved across a read-modify-write operation.
7:0	USEC	R/W	0x31	Microsecond Reload Value  MHz -1 of the controller clock when the flash is being erased or programmed.  USEC should be set to 0x31 (50 MHz) whenever the flash is being erased or programmed.

### Register 8: Flash Memory Protection Read Enable 0 (FMPRE0), offset 0x130 and 0x200

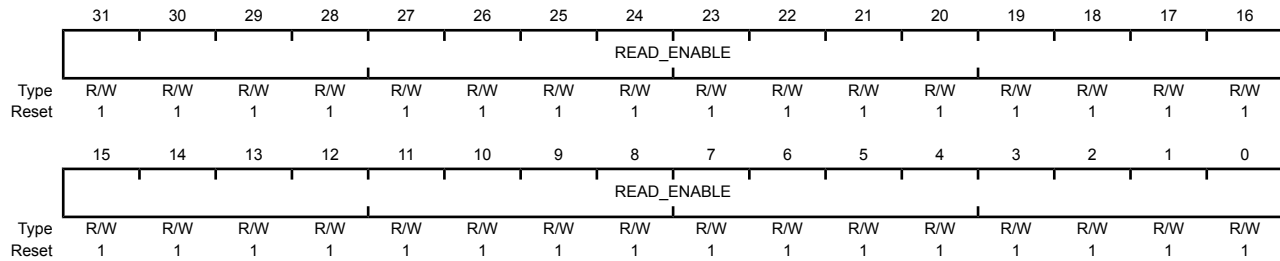
**Note:** This register is aliased for backwards compatibility.

**Note:** Offset is relative to System Control base address of 0x400FE000.

This register stores the read-only protection bits for each 2-KB flash block (**FMPPEn** stores the execute-only bits). This register is loaded during the power-on reset sequence. The factory settings for the **FMPREN** and **FMPPEn** registers are a value of 1 for all implemented banks. This achieves a policy of open access and programmability. The register bits may be changed by writing the specific register bit. However, this register is R/W0; the user can only change the protection bit from a 1 to a 0 (and may NOT change a 0 to a 1). The changes are not permanent until the register is committed (saved), at which point the bit change is permanent. If a bit is changed from a 1 to a 0 and not committed, it may be restored by executing a power-on reset sequence. For additional information, see the "Flash Memory Protection" section.

#### Flash Memory Protection Read Enable 0 (FMPRE0)

Base 0x400F.D000  
 Offset 0x130 and 0x200  
 Type R/W, reset 0xFFFF.FFFF



Bit/Field	Name	Type	Reset	Description
31:0	READ_ENABLE	R/W	0xFFFFFFFF	Flash Read Enable  Enables 2-KB flash blocks to be executed or read. The policies may be combined as shown in the table "Flash Protection Policy Combinations".  Value            Description 0xFFFFFFFF Enables 64 KB of flash.

## Register 9: Flash Memory Protection Program Enable 0 (FMPPE0), offset 0x134 and 0x400

**Note:** This register is aliased for backwards compatibility.

**Note:** Offset is relative to System Control base address of 0x400FE000.

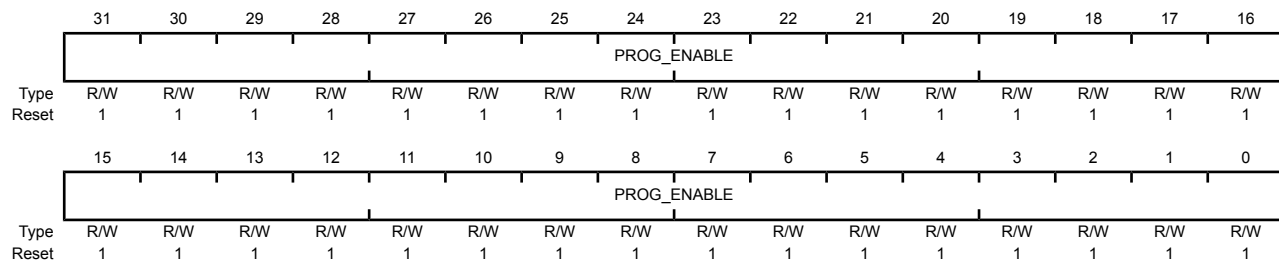
This register stores the execute-only protection bits for each 2-KB flash block (**FMPREN** stores the execute-only bits). This register is loaded during the power-on reset sequence. The factory settings for the **FMPREN** and **FMPPEN** registers are a value of 1 for all implemented banks. This achieves a policy of open access and programmability. The register bits may be changed by writing the specific register bit. However, this register is R/W0; the user can only change the protection bit from a 1 to a 0 (and may NOT change a 0 to a 1). The changes are not permanent until the register is committed (saved), at which point the bit change is permanent. If a bit is changed from a 1 to a 0 and not committed, it may be restored by executing a power-on reset sequence. For additional information, see the "Flash Memory Protection" section.

### Flash Memory Protection Program Enable 0 (FMPPE0)

Base 0x400F.D000

Offset 0x134 and 0x400

Type R/W, reset 0xFFFF.FFFF



Bit/Field	Name	Type	Reset	Description
31:0	PROG_ENABLE	R/W	0xFFFFFFFF	Flash Programming Enable

Configures 2-KB flash blocks to be execute only. The policies may be combined as shown in the table "Flash Protection Policy Combinations".

Value	Description
0xFFFFFFFF	Enables 64 KB of flash.

### Register 10: User Debug (USER\_DBG), offset 0x1D0

**Note:** Offset is relative to System Control base address of 0x400FE000.

This register provides a write-once mechanism to disable external debugger access to the device in addition to 27 additional bits of user-defined data. The `DBG0` bit (bit 0) is set to 0 from the factory and the `DBG1` bit (bit 1) is set to 1, which enables external debuggers. Changing the `DBG1` bit to 0 disables any external debugger access to the device permanently, starting with the next power-up cycle of the device. The `NOTWRITTEN` bit (bit 31) indicates that the register is available to be written and is controlled through hardware to ensure that the register is only written once.

#### User Debug (USER\_DBG)

Base 0x400F.E000

Offset 0x1D0

Type R/W, reset 0xFFFF.FFFE

	31	30	29	28	27	26	25	24	23	22	21	20	19	18	17	16	
	NW	DATA															
Type	R/W	R/W	R/W	R/W	R/W	R/W	R/W	R/W	R/W	R/W	R/W	R/W	R/W	R/W	R/W	R/W	
Reset	1	1	1	1	1	1	1	1	1	1	1	1	1	1	1	1	
	15	14	13	12	11	10	9	8	7	6	5	4	3	2	1	0	
	DATA															DBG1	DBG0
Type	R/W	R/W	R/W	R/W	R/W	R/W	R/W	R/W	R/W	R/W	R/W	R/W	R/W	R/W	R/W	R/W	R/W
Reset	1	1	1	1	1	1	1	1	1	1	1	1	1	1	1	1	0

Bit/Field	Name	Type	Reset	Description
31	NW	R/W	1	User Debug Not Written Specifies that this 32-bit dword has not been written.
30:2	DATA	R/W	0x1FFFFFFF	User Data Contains the user data value. This field is initialized to all 1s and can only be written once.
1	DBG1	R/W	1	Debug Control 1 The <code>DBG1</code> bit must be 1 and <code>DBG0</code> must be 0 for debug to be available.
0	DBG0	R/W	0	Debug Control 0 The <code>DBG1</code> bit must be 1 and <code>DBG0</code> must be 0 for debug to be available.

**Register 11: User Register 0 (USER\_REG0), offset 0x1E0**

**Note:** Offset is relative to System Control base address of 0x400FE000.

This register provides 31 bits of user-defined data that is non-volatile and can only be written once. Bit 31 indicates that the register is available to be written and is controlled through hardware to ensure that the register is only written once. The write-once characteristics of this register are useful for keeping static information like communication addresses that need to be unique per part and would otherwise require an external EEPROM or other non-volatile device.

**User Register 0 (USER\_REG0)**

Base 0x400F.E000

Offset 0x1E0

Type R/W, reset 0xFFFF.FFFF

	31	30	29	28	27	26	25	24	23	22	21	20	19	18	17	16
	NW	DATA														
Type	R/W	R/W	R/W	R/W	R/W	R/W	R/W	R/W	R/W	R/W	R/W	R/W	R/W	R/W	R/W	R/W
Reset	1	1	1	1	1	1	1	1	1	1	1	1	1	1	1	1
	15	14	13	12	11	10	9	8	7	6	5	4	3	2	1	0
	DATA															
Type	R/W	R/W	R/W	R/W	R/W	R/W	R/W	R/W	R/W	R/W	R/W	R/W	R/W	R/W	R/W	R/W
Reset	1	1	1	1	1	1	1	1	1	1	1	1	1	1	1	1

Bit/Field	Name	Type	Reset	Description
31	NW	R/W	1	Not Written Specifies that this 32-bit dword has not been written.
30:0	DATA	R/W	0x7FFFFFFF	User Data Contains the user data value. This field is initialized to all 1s and can only be written once.

### Register 12: User Register 1 (USER\_REG1), offset 0x1E4

**Note:** Offset is relative to System Control base address of 0x400FE000.

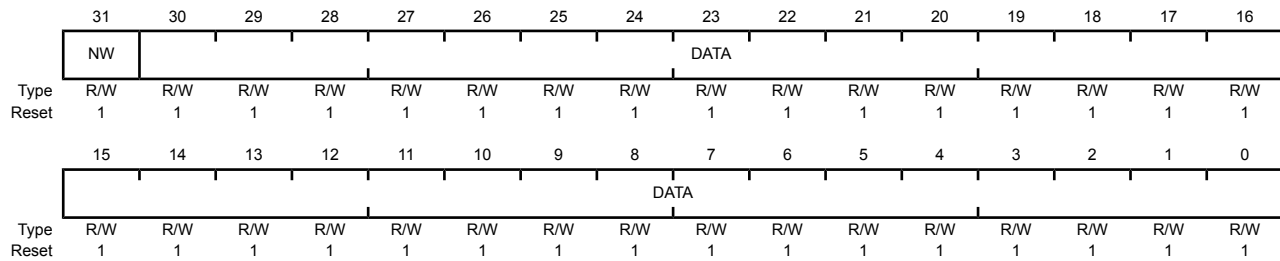
This register provides 31 bits of user-defined data that is non-volatile and can only be written once. Bit 31 indicates that the register is available to be written and is controlled through hardware to ensure that the register is only written once. The write-once characteristics of this register are useful for keeping static information like communication addresses that need to be unique per part and would otherwise require an external EEPROM or other non-volatile device.

#### User Register 1 (USER\_REG1)

Base 0x400F.E000

Offset 0x1E4

Type R/W, reset 0xFFFF.FFFF



Bit/Field	Name	Type	Reset	Description
31	NW	R/W	1	Not Written Specifies that this 32-bit dword has not been written.
30:0	DATA	R/W	0x7FFFFFFF	User Data Contains the user data value. This field is initialized to all 1s and can only be written once.

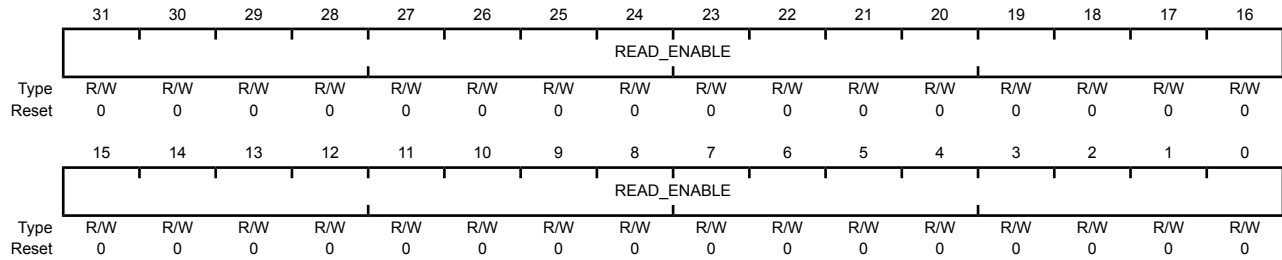
**Register 13: Flash Memory Protection Read Enable 1 (FMPRE1), offset 0x204**

**Note:** Offset is relative to System Control base address of 0x400FE000.

This register stores the read-only protection bits for each 2-KB flash block (**FMPPEn** stores the execute-only bits). This register is loaded during the power-on reset sequence. The factory settings for the **FMPREN** and **FMPPEn** registers are a value of 1 for all implemented banks. This achieves a policy of open access and programmability. The register bits may be changed by writing the specific register bit. However, this register is R/W0; the user can only change the protection bit from a 1 to a 0 (and may NOT change a 0 to a 1). The changes are not permanent until the register is committed (saved), at which point the bit change is permanent. If a bit is changed from a 1 to a 0 and not committed, it may be restored by executing a power-on reset sequence. For additional information, see the "Flash Memory Protection" section.

Flash Memory Protection Read Enable 1 (FMPRE1)

Base 0x400F.E000  
 Offset 0x204  
 Type R/W, reset 0x0000.0000



Bit/Field	Name	Type	Reset	Description
-----------	------	------	-------	-------------

31:0	READ_ENABLE	R/W	0x00000000	Flash Read Enable
------	-------------	-----	------------	-------------------

Enables 2-KB flash blocks to be executed or read. The policies may be combined as shown in the table "Flash Protection Policy Combinations".

Value	Description
0x00000000	Enables 64 KB of flash.

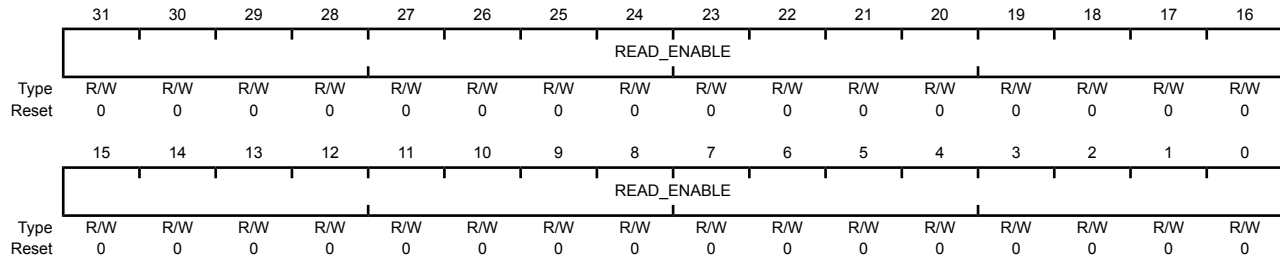
### Register 14: Flash Memory Protection Read Enable 2 (FMPRE2), offset 0x208

**Note:** Offset is relative to System Control base address of 0x400FE000.

This register stores the read-only protection bits for each 2-KB flash block (**FMPPEn** stores the execute-only bits). This register is loaded during the power-on reset sequence. The factory settings for the **FMPREN** and **FMPPEn** registers are a value of 1 for all implemented banks. This achieves a policy of open access and programmability. The register bits may be changed by writing the specific register bit. However, this register is R/W0; the user can only change the protection bit from a 1 to a 0 (and may NOT change a 0 to a 1). The changes are not permanent until the register is committed (saved), at which point the bit change is permanent. If a bit is changed from a 1 to a 0 and not committed, it may be restored by executing a power-on reset sequence. For additional information, see the "Flash Memory Protection" section.

#### Flash Memory Protection Read Enable 2 (FMPRE2)

Base 0x400F.E000  
 Offset 0x208  
 Type R/W, reset 0x0000.0000



Bit/Field	Name	Type	Reset	Description
31:0	READ_ENABLE	R/W	0x00000000	Flash Read Enable  Enables 2-KB flash blocks to be executed or read. The policies may be combined as shown in the table "Flash Protection Policy Combinations".  Value      Description 0x00000000 Enables 64 KB of flash.



## Register 15: Flash Memory Protection Read Enable 3 (FMPRE3), offset 0x20C

**Note:** Offset is relative to System Control base address of 0x400FE000.

This register stores the read-only protection bits for each 2-KB flash block (**FMPPEn** stores the execute-only bits). This register is loaded during the power-on reset sequence. The factory settings for the **FMPREN** and **FMPPEn** registers are a value of 1 for all implemented banks. This achieves a policy of open access and programmability. The register bits may be changed by writing the specific register bit. However, this register is R/W0; the user can only change the protection bit from a 1 to a 0 (and may NOT change a 0 to a 1). The changes are not permanent until the register is committed (saved), at which point the bit change is permanent. If a bit is changed from a 1 to a 0 and not committed, it may be restored by executing a power-on reset sequence. For additional information, see the "Flash Memory Protection" section.

### Flash Memory Protection Read Enable 3 (FMPRE3)

Base 0x400F.E000

Offset 0x20C

Type R/W, reset 0x0000.0000

	31	30	29	28	27	26	25	24	23	22	21	20	19	18	17	16
	READ_ENABLE															
Type	R/W	R/W	R/W	R/W	R/W	R/W	R/W	R/W	R/W	R/W	R/W	R/W	R/W	R/W	R/W	R/W
Reset	0	0	0	0	0	0	0	0	0	0	0	0	0	0	0	0
	15	14	13	12	11	10	9	8	7	6	5	4	3	2	1	0
	READ_ENABLE															
Type	R/W	R/W	R/W	R/W	R/W	R/W	R/W	R/W	R/W	R/W	R/W	R/W	R/W	R/W	R/W	R/W
Reset	0	0	0	0	0	0	0	0	0	0	0	0	0	0	0	0

Bit/Field	Name	Type	Reset	Description
-----------	------	------	-------	-------------

31:0	READ_ENABLE	R/W	0x00000000	Flash Read Enable
------	-------------	-----	------------	-------------------

Enables 2-KB flash blocks to be executed or read. The policies may be combined as shown in the table "Flash Protection Policy Combinations".

Value	Description
-------	-------------

0x00000000	Enables 64 KB of flash.
------------	-------------------------

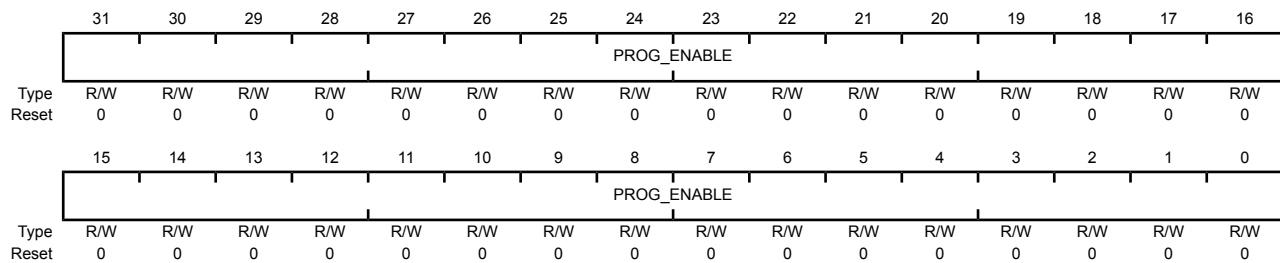
## Register 16: Flash Memory Protection Program Enable 1 (FMPPE1), offset 0x404

**Note:** Offset is relative to System Control base address of 0x400FE000.

This register stores the execute-only protection bits for each 2-KB flash block (**FMPREn** stores the execute-only bits). This register is loaded during the power-on reset sequence. The factory settings for the **FMPREn** and **FMPPEn** registers are a value of 1 for all implemented banks. This achieves a policy of open access and programmability. The register bits may be changed by writing the specific register bit. However, this register is R/W0; the user can only change the protection bit from a 1 to a 0 (and may NOT change a 0 to a 1). The changes are not permanent until the register is committed (saved), at which point the bit change is permanent. If a bit is changed from a 1 to a 0 and not committed, it may be restored by executing a power-on reset sequence. For additional information, see the "Flash Memory Protection" section.

### Flash Memory Protection Program Enable 1 (FMPPE1)

Base 0x400F.E000  
 Offset 0x404  
 Type R/W, reset 0x0000.0000



Bit/Field	Name	Type	Reset	Description
31:0	PROG_ENABLE	R/W	0x00000000	Flash Programming Enable

Configures 2-KB flash blocks to be execute only. The policies may be combined as shown in the table "Flash Protection Policy Combinations".

Value	Description
0x00000000	Enables 64 KB of flash.

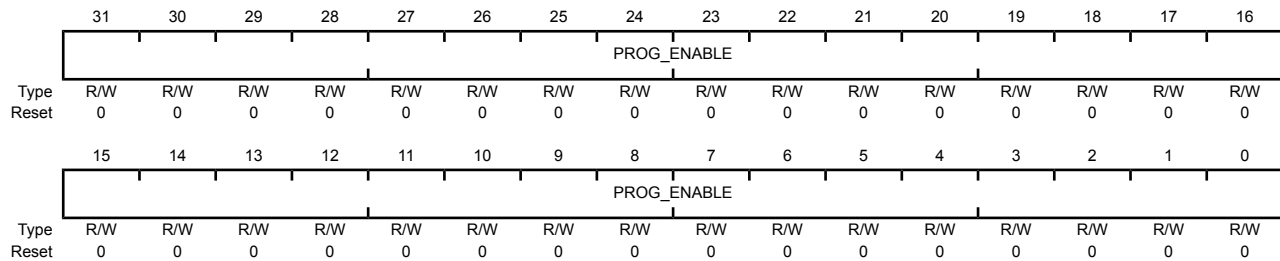
## Register 17: Flash Memory Protection Program Enable 2 (FMPPE2), offset 0x408

**Note:** Offset is relative to System Control base address of 0x400FE000.

This register stores the execute-only protection bits for each 2-KB flash block (**FMPREn** stores the execute-only bits). This register is loaded during the power-on reset sequence. The factory settings for the **FMPREn** and **FMPPEn** registers are a value of 1 for all implemented banks. This achieves a policy of open access and programmability. The register bits may be changed by writing the specific register bit. However, this register is R/W0; the user can only change the protection bit from a 1 to a 0 (and may NOT change a 0 to a 1). The changes are not permanent until the register is committed (saved), at which point the bit change is permanent. If a bit is changed from a 1 to a 0 and not committed, it may be restored by executing a power-on reset sequence. For additional information, see the "Flash Memory Protection" section.

### Flash Memory Protection Program Enable 2 (FMPPE2)

Base 0x400F.E000  
 Offset 0x408  
 Type R/W, reset 0x0000.0000



Bit/Field	Name	Type	Reset	Description
31:0	PROG_ENABLE	R/W	0x00000000	Flash Programming Enable

Configures 2-KB flash blocks to be execute only. The policies may be combined as shown in the table "Flash Protection Policy Combinations".

Value	Description
0x00000000	Enables 64 KB of flash.

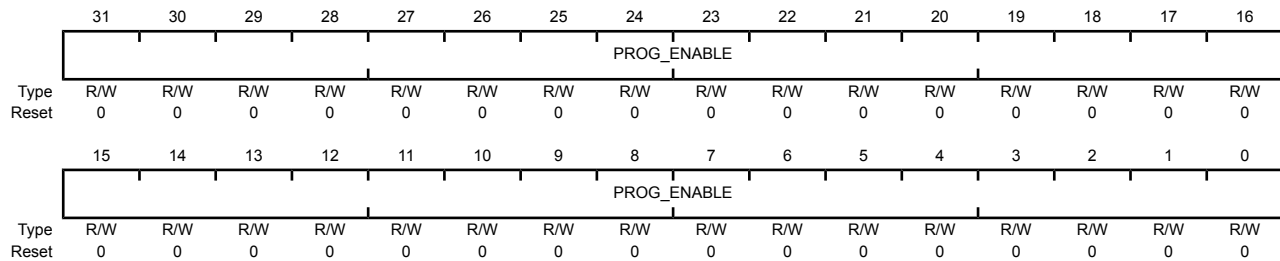
### Register 18: Flash Memory Protection Program Enable 3 (FMPPE3), offset 0x40C

**Note:** Offset is relative to System Control base address of 0x400FE000.

This register stores the execute-only protection bits for each 2-KB flash block (**FMPREn** stores the execute-only bits). This register is loaded during the power-on reset sequence. The factory settings for the **FMPREn** and **FMPPEn** registers are a value of 1 for all implemented banks. This achieves a policy of open access and programmability. The register bits may be changed by writing the specific register bit. However, this register is R/W0; the user can only change the protection bit from a 1 to a 0 (and may NOT change a 0 to a 1). The changes are not permanent until the register is committed (saved), at which point the bit change is permanent. If a bit is changed from a 1 to a 0 and not committed, it may be restored by executing a power-on reset sequence. For additional information, see the "Flash Memory Protection" section.

#### Flash Memory Protection Program Enable 3 (FMPPE3)

Base 0x400F.E000  
 Offset 0x40C  
 Type R/W, reset 0x0000.0000



Bit/Field	Name	Type	Reset	Description
31:0	PROG_ENABLE	R/W	0x00000000	Flash Programming Enable

Configures 2-KB flash blocks to be execute only. The policies may be combined as shown in the table "Flash Protection Policy Combinations".

Value	Description
0x00000000	Enables 64 KB of flash.

## 9 General-Purpose Input/Outputs (GPIOs)

The GPIO module is composed of eight physical GPIO blocks, each corresponding to an individual GPIO port (Port A, Port B, Port C, Port D, Port E, Port F, Port G, and Port H). The GPIO module is FIRMs-compliant and supports 9-46 programmable input/output pins, depending on the peripherals being used.

The GPIO module has the following features:

- Programmable control for GPIO interrupts
  - Interrupt generation masking
  - Edge-triggered on rising, falling, or both
  - Level-sensitive on High or Low values
- 5-V-tolerant input/outputs
- Bit masking in both read and write operations through address lines
- Programmable control for GPIO pad configuration
  - Weak pull-up or pull-down resistors
  - 2-mA, 4-mA, and 8-mA pad drive
  - Slew rate control for the 8-mA drive
  - Open drain enables
  - Digital input enables

### 9.1 Functional Description

**Important:** All GPIO pins are tri-stated by default (**GPIOAFSEL=0**, **GPIODEN=0**, **GPIOPDR=0**, and **GPIOPUR=0**), with the exception of the five JTAG/SWD pins (**PB7** and **PC[3:0]**). The JTAG/SWD pins default to their JTAG/SWD functionality (**GPIOAFSEL=1**, **GPIODEN=1** and **GPIOPUR=1**). A Power-On-Reset ( $\overline{POR}$ ) or asserting  $\overline{RST}$  puts both groups of pins back to their default state.

Each GPIO port is a separate hardware instantiation of the same physical block. The LM3S1138 microcontroller contains eight ports and thus eight of these physical GPIO blocks.

#### 9.1.1 Data Control

The data control registers allow software to configure the operational modes of the GPIOs. The data direction register configures the GPIO as an input or an output while the data register either captures incoming data or drives it out to the pads.

##### 9.1.1.1 Data Direction Operation

The **GPIO Direction (GPIODIR)** register (see page 165) is used to configure each individual pin as an input or output. When the data direction bit is set to 0, the GPIO is configured as an input and the corresponding data register bit will capture and store the value on the GPIO port. When the data

direction bit is set to 1, the GPIO is configured as an output and the corresponding data register bit will be driven out on the GPIO port.

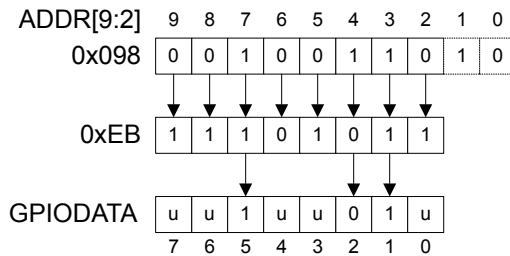
### 9.1.1.2 Data Register Operation

To aid in the efficiency of software, the GPIO ports allow for the modification of individual bits in the **GPIO Data (GPIODATA)** register (see page 164) by using bits [9:2] of the address bus as a mask. This allows software drivers to modify individual GPIO pins in a single instruction, without affecting the state of the other pins. This is in contrast to the "typical" method of doing a read-modify-write operation to set or clear an individual GPIO pin. To accommodate this feature, the **GPIODATA** register covers 256 locations in the memory map.

During a write, if the address bit associated with that data bit is set to 1, the value of the **GPIODATA** register is altered. If it is cleared to 0, it is left unchanged.

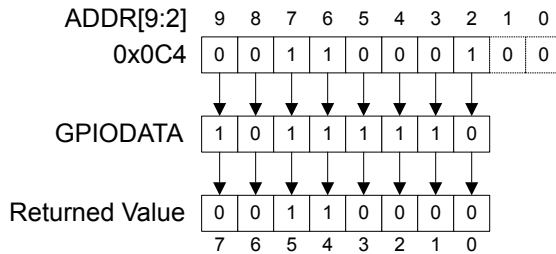
For example, writing a value of 0xEB to the address GPIODATA + 0x098 would yield as shown in Figure 9-1 on page 158, where u is data unchanged by the write.

**Figure 9-1. GPIODATA Write Example**



During a read, if the address bit associated with the data bit is set to 1, the value is read. If the address bit associated with the data bit is set to 0, it is read as a zero, regardless of its actual value. For example, reading address GPIODATA + 0x0C4 yields as shown in Figure 9-2 on page 158.

**Figure 9-2. GPIODATA Read Example**



### 9.1.2 Interrupt Control

The interrupt capabilities of each GPIO port are controlled by a set of seven registers. With these registers, it is possible to select the source of the interrupt, its polarity, and the edge properties. When one or more GPIO inputs cause an interrupt, a single interrupt output is sent to the interrupt controller for the entire GPIO port. For edge-triggered interrupts, software must clear the interrupt to enable any further interrupts. For a level-sensitive interrupt, it is assumed that the external source holds the level constant for the interrupt to be recognized by the controller.

Three registers are required to define the edge or sense that causes interrupts:

- **GPIO Interrupt Sense (GPIOIS)** register (see page 166)
- **GPIO Interrupt Both Edges (GPIOIBE)** register (see page 167)
- **GPIO Interrupt Event (GPIOIEV)** register (see page 168)

Interrupts are enabled/disabled via the **GPIO Interrupt Mask (GPIOIM)** register (see page 169).

When an interrupt condition occurs, the state of the interrupt signal can be viewed in two locations: the **GPIO Raw Interrupt Status (GPIORIS)** and **GPIO Masked Interrupt Status (GPIOMIS)** registers (see page 170 and page 171). As the name implies, the **GPIOMIS** register only shows interrupt conditions that are allowed to be passed to the controller. The **GPIORIS** register indicates that a GPIO pin meets the conditions for an interrupt, but has not necessarily been sent to the controller.

In addition to providing GPIO functionality,  $PB4$  can also be used as an external trigger for the ADC. If  $PB4$  is configured as a non-masked interrupt pin (**GPIOIM** is set to 1), not only is an interrupt for PortB generated, but an external trigger signal is sent to the ADC. If the **ADC Event Multiplexer Select (ADCEMUX)** register is configured to use the external trigger, an ADC conversion is initiated.

If no other PortB pins are being used to generate interrupts, the ARM Integrated Nested Vectored Interrupt Controller (NVIC) Interrupt Set Enable (SETNA) register can disable the PortB interrupts and the ADC interrupt can be used to read back the converted data. Otherwise, the PortB interrupt handler needs to ignore and clear interrupts on  $B4$ , and wait for the ADC interrupt or the ADC interrupt needs to be disabled in the SETNA register and the PortB interrupt handler polls the ADC registers until the conversion is completed.

Interrupts are cleared by writing a 1 to the **GPIO Interrupt Clear (GPIOICR)** register (see page 172).

When programming the following interrupt control registers, the interrupts should be masked (**GPIOIM** set to 0). Writing any value to an interrupt control register (**GPIOIS**, **GPIOIBE**, or **GPIOIEV**) can generate a spurious interrupt if the corresponding bits are enabled.

### 9.1.3 Mode Control

The GPIO pins can be controlled by either hardware or software. When hardware control is enabled via the **GPIO Alternate Function Select (GPIOAFSEL)** register (see page 173), the pin state is controlled by its alternate function (that is, the peripheral). Software control corresponds to GPIO mode, where the **GPIO DATA** register is used to read/write the corresponding pins.

### 9.1.4 Commit Control

The commit control registers provide a layer of protection against accidental programming of critical hardware peripherals. Writes to protected bits of the **GPIO Alternate Function Select (GPIOAFSEL)** register (see page 173) are not committed to storage unless the **GPIO Lock (GPIOLOCK)** register (see page 183) has been unlocked and the appropriate bits of the **GPIO Commit (GPIOCR)** register (see page 184) have been set to 1.

### 9.1.5 Pad Control

The pad control registers allow for GPIO pad configuration by software based on the application requirements. The pad control registers include the **GPIO DR2R**, **GPIO DR4R**, **GPIO DR8R**, **GPIO DR**, **GPIO PUR**, **GPIO PDR**, **GPIO SLR**, and **GPIO DEN** registers.

### 9.1.6 Identification

The identification registers configured at reset allow software to detect and identify the module as a GPIO block. The identification registers include the **GPIOPeriphID0-GPIOPeriphID7** registers as well as the **GPIOCellID0-GPIOCellID3** registers.

## 9.2 Initialization and Configuration

To use the GPIO, the peripheral clock must be enabled by setting the appropriate GPIO Port bit field (**GPIO<sub>n</sub>**) in the **RCGC2** register.

On reset, all GPIO pins (except for the five JTAG pins) are configured out of reset to be undriven (tristate): **GPIOAFSEL=0**, **GPIODEN=0**, **GPIOPDR=0**, and **GPIOPUR=0**. Table 9-1 on page 160 shows all possible configurations of the GPIO pads and the control register settings required to achieve them. Table 9-2 on page 160 shows how a rising edge interrupt would be configured for pin 2 of a GPIO port.

**Table 9-1. GPIO Pad Configuration Examples**

Configuration	GPIO Register Bit Value <sup>a</sup>									
	AFSEL	DIR	ODR	DEN	PUR	PDR	DR2R	DR4R	DR8R	SLR
Digital Input (GPIO)	0	0	0	1	?	?	X	X	X	X
Digital Output (GPIO)	0	1	0	1	?	?	?	?	?	?
Open Drain Input (GPIO)	0	0	1	1	X	X	X	X	X	X
Open Drain Output (GPIO)	0	1	1	1	X	X	?	?	?	?
Open Drain Input/Output (I <sup>2</sup> C)	1	X	1	1	X	X	?	?	?	?
Digital Input (Timer CCP)	1	X	0	1	?	?	X	X	X	X
Digital Output (Timer PWM)	1	X	0	1	?	?	?	?	?	?
Digital Input/Output (SSI)	1	X	0	1	?	?	?	?	?	?
Digital Input/Output (UART)	1	X	0	1	?	?	?	?	?	?
Analog Input (Comparator)	0	0	0	0	0	0	X	X	X	X
Digital Output (Comparator)	1	X	0	1	?	?	?	?	?	?

a. X=Ignored (don't care bit)

?=Can be either 0 or 1, depending on the configuration

**Table 9-2. GPIO Interrupt Configuration Example**

Register	Desired Interrupt Event Trigger	Pin 2 Bit Value <sup>a</sup>							
		7	6	5	4	3	2	1	0
GPIOIS	0=edge	X	X	X	X	X	0	X	X
	1=level								



Register	Desired Interrupt Event Trigger	Pin 2 Bit Value <sup>a</sup>							
		7	6	5	4	3	2	1	0
GPIOIBE	0=single edge 1=both edges	X	X	X	X	X	0	X	X
GPIOIEV	0=Low level, or negative edge 1=High level, or positive edge	X	X	X	X	X	1	X	X
GPIOIM	0=masked 1=not masked	0	0	0	0	0	1	0	0

a. X=Ignored (don't care bit)

### 9.3 Register Map

Table 9-3 on page 162 lists the GPIO registers. The offset listed is a hexadecimal increment to the register's address, relative to that GPIO port's base address:

- GPIO Port A: 0x4000.4000
- GPIO Port B: 0x4000.5000
- GPIO Port C: 0x4000.6000
- GPIO Port D: 0x4000.7000
- GPIO Port E: 0x4002.4000
- GPIO Port F: 0x4002.5000
- GPIO Port G: 0x4002.6000
- GPIO Port H: 0x4002.7000

**Important:** The GPIO registers in this chapter are duplicated in each GPIO block, however, depending on the block, all eight bits may not be connected to a GPIO pad. In those cases, writing to those unconnected bits has no effect and reading those unconnected bits returns no meaningful data.

**Note:** The default reset value for the **GPIOAFSEL**, **GPIOPUR**, and **GPIODEN** registers are 0x0000.0000 for all GPIO pins, with the exception of the five JTAG/SWD pins (**PB7** and **PC[3:0]**). These five pins default to JTAG/SWD functionality. Because of this, the default reset value of these registers for GPIO Port B is 0x0000.0080 while the default reset value for Port C is 0x0000.000F.

The default register type for the **GPIOCR** register is RO for all GPIO pins, with the exception of the five JTAG/SWD pins (**PB7** and **PC[3:0]**). These five pins are currently the only

GPIOs that are protected by the **GPIOCR** register. Because of this, the register type for GPIO Port B7 and GPIO Port C[3:0] is R/W.

The default reset value for the **GPIOCR** register is 0x0000.00FF for all GPIO pins, with the exception of the five JTAG/SWD pins ( $PB7$  and  $PC[3:0]$ ). To ensure that the JTAG port is not accidentally programmed as a GPIO, these five pins default to non-committable. Because of this, the default reset value of **GPIOCR** for GPIO Port B is 0x0000.007F while the default reset value of **GPIOCR** for Port C is 0x0000.00F0.

**Table 9-3. GPIO Register Map**

Offset	Name	Type	Reset	Description	See page
0x000	GPIODATA	R/W	0x0000.0000	GPIO Data	164
0x400	GPIODIR	R/W	0x0000.0000	GPIO Direction	165
0x404	GPIOIS	R/W	0x0000.0000	GPIO Interrupt Sense	166
0x408	GPIOIBE	R/W	0x0000.0000	GPIO Interrupt Both Edges	167
0x40C	GPIOIEV	R/W	0x0000.0000	GPIO Interrupt Event	168
0x410	GPIOIM	R/W	0x0000.0000	GPIO Interrupt Mask	169
0x414	GPIORIS	RO	0x0000.0000	GPIO Raw Interrupt Status	170
0x418	GPIONIS	RO	0x0000.0000	GPIO Masked Interrupt Status	171
0x41C	GPIOICR	W1C	0x0000.0000	GPIO Interrupt Clear	172
0x420	GPIOAFSEL	R/W	-	GPIO Alternate Function Select	173
0x500	GPIODR2R	R/W	0x0000.00FF	GPIO 2-mA Drive Select	175
0x504	GPIODR4R	R/W	0x0000.0000	GPIO 4-mA Drive Select	176
0x508	GPIODR8R	R/W	0x0000.0000	GPIO 8-mA Drive Select	177
0x50C	GPIOODR	R/W	0x0000.0000	GPIO Open Drain Select	178
0x510	GPIOPUR	R/W	-	GPIO Pull-Up Select	179
0x514	GPIOPDR	R/W	0x0000.0000	GPIO Pull-Down Select	180
0x518	GPIOSLR	R/W	0x0000.0000	GPIO Slew Rate Control Select	181
0x51C	GPIODEN	R/W	-	GPIO Digital Enable	182
0x520	GPIOLOCK	R/W	0x0000.0001	GPIO Lock	183
0x524	GPIOCR	-	-	GPIO Commit	184
0xFD0	GPIOPeriphID4	RO	0x0000.0000	GPIO Peripheral Identification 4	186
0xFD4	GPIOPeriphID5	RO	0x0000.0000	GPIO Peripheral Identification 5	187
0xFD8	GPIOPeriphID6	RO	0x0000.0000	GPIO Peripheral Identification 6	188
0xFDC	GPIOPeriphID7	RO	0x0000.0000	GPIO Peripheral Identification 7	189
0xFE0	GPIOPeriphID0	RO	0x0000.0061	GPIO Peripheral Identification 0	190
0xFE4	GPIOPeriphID1	RO	0x0000.0000	GPIO Peripheral Identification 1	191

Offset	Name	Type	Reset	Description	See page
0xFE8	GPIOPeriphID2	RO	0x0000.0018	GPIO Peripheral Identification 2	192
0xFEC	GPIOPeriphID3	RO	0x0000.0001	GPIO Peripheral Identification 3	193
0xFF0	GPIOCellID0	RO	0x0000.000D	GPIO PrimeCell Identification 0	194
0xFF4	GPIOCellID1	RO	0x0000.00F0	GPIO PrimeCell Identification 1	195
0xFF8	GPIOCellID2	RO	0x0000.0005	GPIO PrimeCell Identification 2	196
0xFFC	GPIOCellID3	RO	0x0000.00B1	GPIO PrimeCell Identification 3	197

## 9.4 Register Descriptions

The remainder of this section lists and describes the GPIO registers, in numerical order by address offset.

### Register 1: GPIO Data (GPIODATA), offset 0x000

The **GPIODATA** register is the data register. In software control mode, values written in the **GPIODATA** register are transferred onto the GPIO port pins if the respective pins have been configured as outputs through the **GPIO Direction (GPIODIR)** register (see page 165).

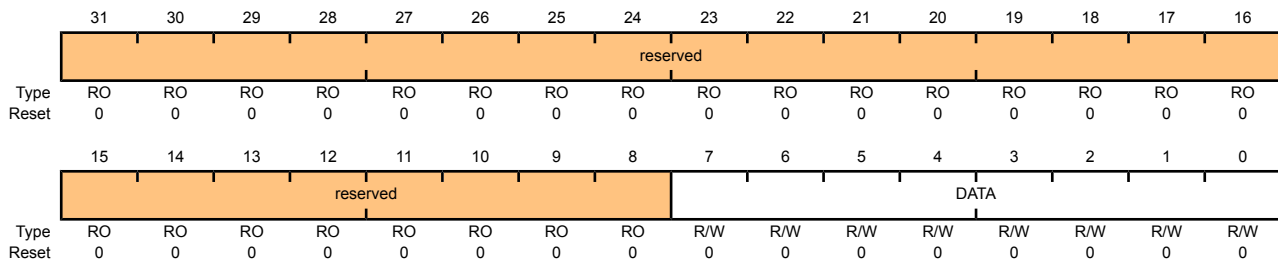
In order to write to **GPIODATA**, the corresponding bits in the mask, resulting from the address bus bits [9:2], must be High. Otherwise, the bit values remain unchanged by the write.

Similarly, the values read from this register are determined for each bit by the mask bit derived from the address used to access the data register, bits [9:2]. Bits that are 1 in the address mask cause the corresponding bits in **GPIODATA** to be read, and bits that are 0 in the address mask cause the corresponding bits in **GPIODATA** to be read as 0, regardless of their value.

A read from **GPIODATA** returns the last bit value written if the respective pins are configured as outputs, or it returns the value on the corresponding input pin when these are configured as inputs. All bits are cleared by a reset.

#### GPIO Data (GPIODATA)

GPIO Port A base: 0x4000.4000  
 GPIO Port B base: 0x4000.5000  
 GPIO Port C base: 0x4000.6000  
 GPIO Port D base: 0x4000.7000  
 GPIO Port E base: 0x4002.4000  
 GPIO Port F base: 0x4002.5000  
 GPIO Port G base: 0x4002.6000  
 GPIO Port H base: 0x4002.7000  
 Offset 0x000  
 Type R/W, reset 0x0000.0000



Bit/Field	Name	Type	Reset	Description
31:8	reserved	RO	0x00	Software should not rely on the value of a reserved bit. To provide compatibility with future products, the value of a reserved bit should be preserved across a read-modify-write operation.
7:0	DATA	R/W	0x00	GPIO Data

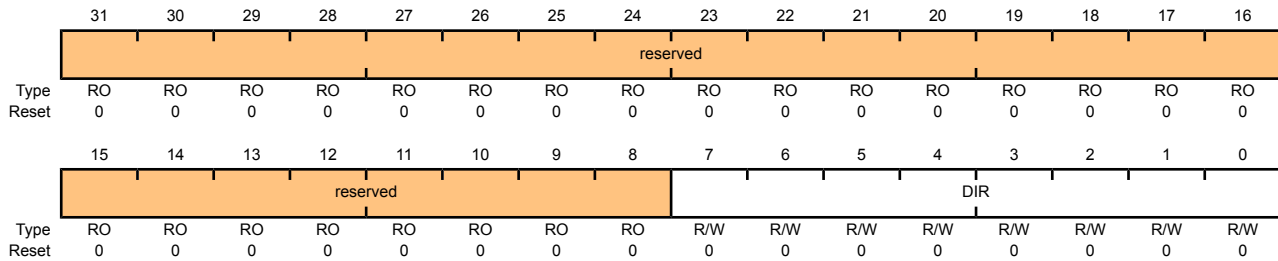
This register is virtually mapped to 256 locations in the address space. To facilitate the reading and writing of data to these registers by independent drivers, the data read from and the data written to the registers are masked by the eight address lines `ipaddr[9:2]`. Reads from this register return its current state. Writes to this register only affect bits that are not masked by `ipaddr[9:2]` and are configured as outputs. See "Data Register Operation" on page 158 for examples of reads and writes.

## Register 2: GPIO Direction (GPIODIR), offset 0x400

The **GPIODIR** register is the data direction register. Bits set to 1 in the **GPIODIR** register configure the corresponding pin to be an output, while bits set to 0 configure the pins to be inputs. All bits are cleared by a reset, meaning all GPIO pins are inputs by default.

### GPIO Direction (GPIODIR)

GPIO Port A base: 0x4000.4000  
 GPIO Port B base: 0x4000.5000  
 GPIO Port C base: 0x4000.6000  
 GPIO Port D base: 0x4000.7000  
 GPIO Port E base: 0x4002.4000  
 GPIO Port F base: 0x4002.5000  
 GPIO Port G base: 0x4002.6000  
 GPIO Port H base: 0x4002.7000  
 Offset 0x400  
 Type R/W, reset 0x0000.0000



Bit/Field	Name	Type	Reset	Description
31:8	reserved	RO	0x00	Software should not rely on the value of a reserved bit. To provide compatibility with future products, the value of a reserved bit should be preserved across a read-modify-write operation.
7:0	DIR	R/W	0x00	GPIO Data Direction

The **DIR** values are defined as follows:

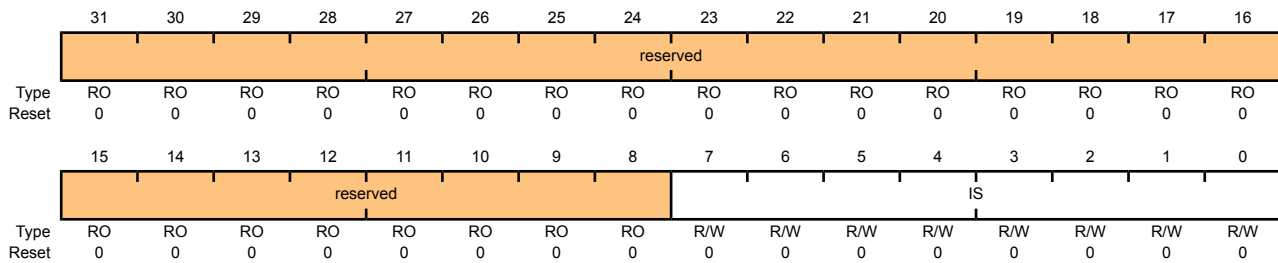
Value	Description
0	Pins are inputs.
1	Pins are outputs.

### Register 3: GPIO Interrupt Sense (GPIOIS), offset 0x404

The **GPIOIS** register is the interrupt sense register. Bits set to 1 in **GPIOIS** configure the corresponding pins to detect levels, while bits set to 0 configure the pins to detect edges. All bits are cleared by a reset.

#### GPIO Interrupt Sense (GPIOIS)

GPIO Port A base: 0x4000.4000  
 GPIO Port B base: 0x4000.5000  
 GPIO Port C base: 0x4000.6000  
 GPIO Port D base: 0x4000.7000  
 GPIO Port E base: 0x4002.4000  
 GPIO Port F base: 0x4002.5000  
 GPIO Port G base: 0x4002.6000  
 GPIO Port H base: 0x4002.7000  
 Offset 0x404  
 Type R/W, reset 0x0000.0000



Bit/Field	Name	Type	Reset	Description
31:8	reserved	RO	0x00	Software should not rely on the value of a reserved bit. To provide compatibility with future products, the value of a reserved bit should be preserved across a read-modify-write operation.
7:0	IS	R/W	0x00	GPIO Interrupt Sense

The **IS** values are defined as follows:

Value	Description
0	Edge on corresponding pin is detected (edge-sensitive).
1	Level on corresponding pin is detected (level-sensitive).

## Register 4: GPIO Interrupt Both Edges (GPIOIBE), offset 0x408

The **GPIOIBE** register is the interrupt both-edges register. When the corresponding bit in the **GPIO Interrupt Sense (GPIOIS)** register (see page 166) is set to detect edges, bits set to High in **GPIOIBE** configure the corresponding pin to detect both rising and falling edges, regardless of the corresponding bit in the **GPIO Interrupt Event (GPIOIEV)** register (see page 168). Clearing a bit configures the pin to be controlled by **GPIOIEV**. All bits are cleared by a reset.

### GPIO Interrupt Both Edges (GPIOIBE)

GPIO Port A base: 0x4000.4000  
 GPIO Port B base: 0x4000.5000  
 GPIO Port C base: 0x4000.6000  
 GPIO Port D base: 0x4000.7000  
 GPIO Port E base: 0x4002.4000  
 GPIO Port F base: 0x4002.5000  
 GPIO Port G base: 0x4002.6000  
 GPIO Port H base: 0x4002.7000  
 Offset 0x408  
 Type R/W, reset 0x0000.0000

	31	30	29	28	27	26	25	24	23	22	21	20	19	18	17	16
	reserved															
Type	RO	RO	RO	RO	RO	RO	RO	RO	RO	RO	RO	RO	RO	RO	RO	RO
Reset	0	0	0	0	0	0	0	0	0	0	0	0	0	0	0	0
	15	14	13	12	11	10	9	8	7	6	5	4	3	2	1	0
	reserved								IBE							
Type	RO	RO	RO	RO	RO	RO	RO	RO	R/W	R/W	R/W	R/W	R/W	R/W	R/W	R/W
Reset	0	0	0	0	0	0	0	0	0	0	0	0	0	0	0	0

Bit/Field	Name	Type	Reset	Description
31:8	reserved	RO	0x00	Software should not rely on the value of a reserved bit. To provide compatibility with future products, the value of a reserved bit should be preserved across a read-modify-write operation.
7:0	IBE	R/W	0x00	GPIO Interrupt Both Edges

The **IBE** values are defined as follows:

#### Value Description

- 0 Interrupt generation is controlled by the **GPIO Interrupt Event (GPIOIEV)** register (see page 168).
- 1 Both edges on the corresponding pin trigger an interrupt.

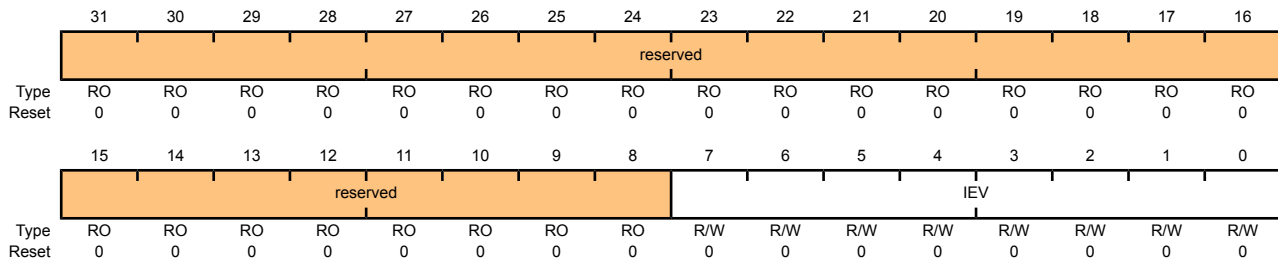
**Note:** Single edge is determined by the corresponding bit in **GPIOIEV**.

### Register 5: GPIO Interrupt Event (GPIOIEV), offset 0x40C

The **GPIOIEV** register is the interrupt event register. Bits set to High in **GPIOIEV** configure the corresponding pin to detect rising edges or high levels, depending on the corresponding bit value in the **GPIO Interrupt Sense (GPIOIS)** register (see page 166). Clearing a bit configures the pin to detect falling edges or low levels, depending on the corresponding bit value in **GPIOIS**. All bits are cleared by a reset.

#### GPIO Interrupt Event (GPIOIEV)

GPIO Port A base: 0x4000.4000  
 GPIO Port B base: 0x4000.5000  
 GPIO Port C base: 0x4000.6000  
 GPIO Port D base: 0x4000.7000  
 GPIO Port E base: 0x4002.4000  
 GPIO Port F base: 0x4002.5000  
 GPIO Port G base: 0x4002.6000  
 GPIO Port H base: 0x4002.7000  
 Offset 0x40C  
 Type R/W, reset 0x0000.0000



Bit/Field	Name	Type	Reset	Description
31:8	reserved	RO	0x00	Software should not rely on the value of a reserved bit. To provide compatibility with future products, the value of a reserved bit should be preserved across a read-modify-write operation.
7:0	IEV	R/W	0x00	GPIO Interrupt Event

- The **IEV** values are defined as follows:
- | Value | Description  |
|-------|--|
| 0     | Falling edge or Low levels on corresponding pins trigger interrupts. |
| 1     | Rising edge or High levels on corresponding pins trigger interrupts. |



## Register 6: GPIO Interrupt Mask (GPIOIM), offset 0x410

The **GPIOIM** register is the interrupt mask register. Bits set to High in **GPIOIM** allow the corresponding pins to trigger their individual interrupts and the combined GPIOINTR line. Clearing a bit disables interrupt triggering on that pin. All bits are cleared by a reset.

### GPIO Interrupt Mask (GPIOIM)

GPIO Port A base: 0x4000.4000

GPIO Port B base: 0x4000.5000

GPIO Port C base: 0x4000.6000

GPIO Port D base: 0x4000.7000

GPIO Port E base: 0x4002.4000

GPIO Port F base: 0x4002.5000

GPIO Port G base: 0x4002.6000

GPIO Port H base: 0x4002.7000

Offset 0x410

Type R/W, reset 0x0000.0000

	31	30	29	28	27	26	25	24	23	22	21	20	19	18	17	16
	reserved															
Type	RO	RO	RO	RO	RO	RO	RO	RO	RO	RO	RO	RO	RO	RO	RO	RO
Reset	0	0	0	0	0	0	0	0	0	0	0	0	0	0	0	0
	15	14	13	12	11	10	9	8	7	6	5	4	3	2	1	0
	reserved								IME							
Type	RO	RO	RO	RO	RO	RO	RO	RO	R/W	R/W	R/W	R/W	R/W	R/W	R/W	R/W
Reset	0	0	0	0	0	0	0	0	0	0	0	0	0	0	0	0

Bit/Field	Name	Type	Reset	Description
31:8	reserved	RO	0x00	Software should not rely on the value of a reserved bit. To provide compatibility with future products, the value of a reserved bit should be preserved across a read-modify-write operation.
7:0	IME	R/W	0x00	GPIO Interrupt Mask Enable

The **IME** values are defined as follows:

#### Value Description

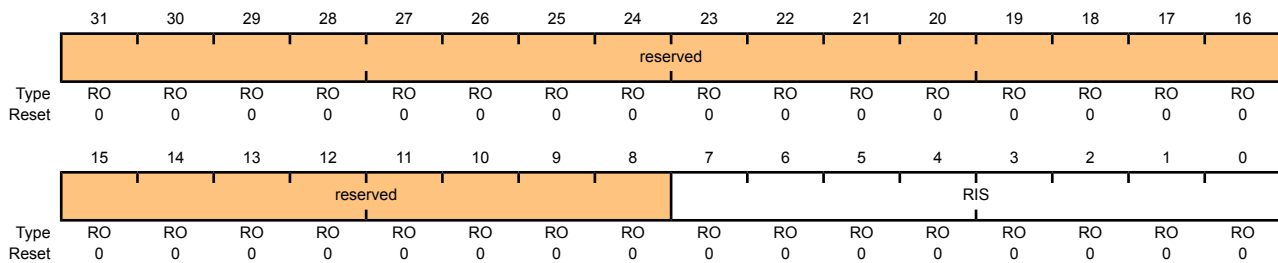
- 0 Corresponding pin interrupt is masked.
- 1 Corresponding pin interrupt is not masked.

### Register 7: GPIO Raw Interrupt Status (GPIORIS), offset 0x414

The **GPIORIS** register is the raw interrupt status register. Bits read High in **GPIORIS** reflect the status of interrupt trigger conditions detected (raw, prior to masking), indicating that all the requirements have been met, before they are finally allowed to trigger by the **GPIO Interrupt Mask (GPIOIM)** register (see page 169). Bits read as zero indicate that corresponding input pins have not initiated an interrupt. All bits are cleared by a reset.

#### GPIO Raw Interrupt Status (GPIORIS)

GPIO Port A base: 0x4000.4000  
 GPIO Port B base: 0x4000.5000  
 GPIO Port C base: 0x4000.6000  
 GPIO Port D base: 0x4000.7000  
 GPIO Port E base: 0x4002.4000  
 GPIO Port F base: 0x4002.5000  
 GPIO Port G base: 0x4002.6000  
 GPIO Port H base: 0x4002.7000  
 Offset 0x414  
 Type RO, reset 0x0000.0000



Bit/Field	Name	Type	Reset	Description
31:8	reserved	RO	0x00	Software should not rely on the value of a reserved bit. To provide compatibility with future products, the value of a reserved bit should be preserved across a read-modify-write operation.
7:0	RIS	RO	0x00	GPIO Interrupt Raw Status Reflects the status of interrupt trigger condition detection on pins (raw, prior to masking).

The RIS values are defined as follows:

Value	Description
0	Corresponding pin interrupt requirements not met.
1	Corresponding pin interrupt has met requirements.

### Register 8: GPIO Masked Interrupt Status (GPIOMIS), offset 0x418

The **GPIOMIS** register is the masked interrupt status register. Bits read High in **GPIOMIS** reflect the status of input lines triggering an interrupt. Bits read as Low indicate that either no interrupt has been generated, or the interrupt is masked.

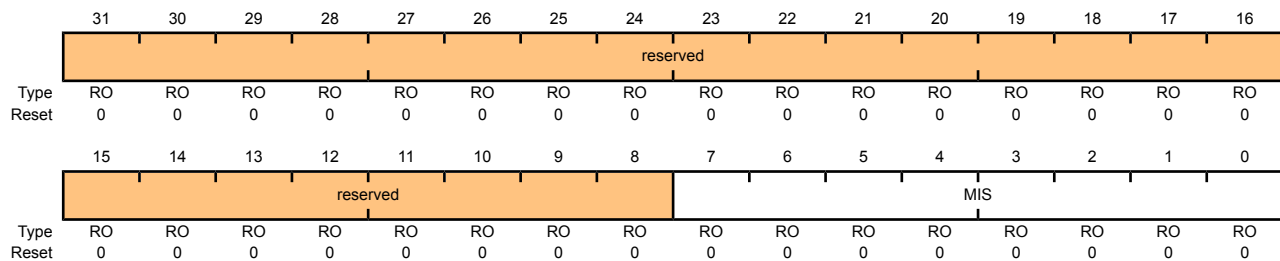
In addition to providing GPIO functionality, **PB4** can also be used as an external trigger for the ADC. If **PB4** is configured as a non-masked interrupt pin (**GPIOIM** is set to 1), not only is an interrupt for PortB generated, but an external trigger signal is sent to the ADC. If the **ADC Event Multiplexer Select (ADCEMUX)** register is configured to use the external trigger, an ADC conversion is initiated.

If no other PortB pins are being used to generate interrupts, the ARM Integrated Nested Vectored Interrupt Controller (NVIC) Interrupt Set Enable (SETNA) register can disable the PortB interrupts and the ADC interrupt can be used to read back the converted data. Otherwise, the PortB interrupt handler needs to ignore and clear interrupts on B4, and wait for the ADC interrupt or the ADC interrupt needs to be disabled in the SETNA register and the PortB interrupt handler polls the ADC registers until the conversion is completed.

**GPIOMIS** is the state of the interrupt after masking.

#### GPIO Masked Interrupt Status (GPIOMIS)

GPIO Port A base: 0x4000.4000  
 GPIO Port B base: 0x4000.5000  
 GPIO Port C base: 0x4000.6000  
 GPIO Port D base: 0x4000.7000  
 GPIO Port E base: 0x4002.4000  
 GPIO Port F base: 0x4002.5000  
 GPIO Port G base: 0x4002.6000  
 GPIO Port H base: 0x4002.7000  
 Offset 0x418  
 Type RO, reset 0x0000.0000



Bit/Field	Name	Type	Reset	Description
31:8	reserved	RO	0x00	Software should not rely on the value of a reserved bit. To provide compatibility with future products, the value of a reserved bit should be preserved across a read-modify-write operation.
7:0	MIS	RO	0x00	GPIO Masked Interrupt Status

Masked value of interrupt due to corresponding pin.  
 The MIS values are defined as follows:

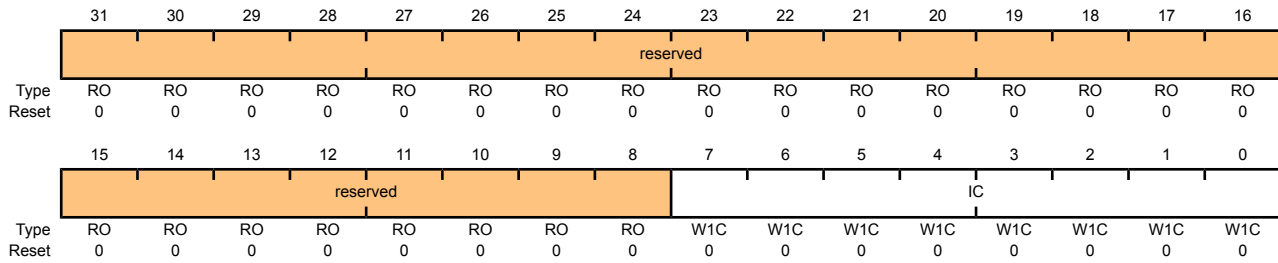
Value	Description
0	Corresponding GPIO line interrupt not active.
1	Corresponding GPIO line asserting interrupt.

### Register 9: GPIO Interrupt Clear (GPIOICR), offset 0x41C

The **GPIOICR** register is the interrupt clear register. Writing a 1 to a bit in this register clears the corresponding interrupt edge detection logic register. Writing a 0 has no effect.

#### GPIO Interrupt Clear (GPIOICR)

GPIO Port A base: 0x4000.4000  
 GPIO Port B base: 0x4000.5000  
 GPIO Port C base: 0x4000.6000  
 GPIO Port D base: 0x4000.7000  
 GPIO Port E base: 0x4002.4000  
 GPIO Port F base: 0x4002.5000  
 GPIO Port G base: 0x4002.6000  
 GPIO Port H base: 0x4002.7000  
 Offset 0x41C  
 Type W1C, reset 0x0000.0000



Bit/Field	Name	Type	Reset	Description
31:8	reserved	RO	0x00	Software should not rely on the value of a reserved bit. To provide compatibility with future products, the value of a reserved bit should be preserved across a read-modify-write operation.
7:0	IC	W1C	0x00	GPIO Interrupt Clear

The IC values are defined as follows:

Value	Description
0	Corresponding interrupt is unaffected.
1	Corresponding interrupt is cleared.

## Register 10: GPIO Alternate Function Select (GPIOAFSEL), offset 0x420

The **GPIOAFSEL** register is the mode control select register. Writing a 1 to any bit in this register selects the hardware control for the corresponding GPIO line. All bits are cleared by a reset, therefore no GPIO line is set to hardware control by default.

The commit control registers provide a layer of protection against accidental programming of critical hardware peripherals. Writes to protected bits of the **GPIO Alternate Function Select (GPIOAFSEL)** register (see page 173) are not committed to storage unless the **GPIO Lock (GPIOLOCK)** register (see page 183) has been unlocked and the appropriate bits of the **GPIO Commit (GPIOCR)** register (see page 184) have been set to 1.

**Important:** All GPIO pins are tri-stated by default (**GPIOAFSEL=0**, **GIODEN=0**, **GPIOPDR=0**, and **GPIOPUR=0**), with the exception of the five JTAG/SWD pins (**PB7** and **PC[3:0]**). The JTAG/SWD pins default to their JTAG/SWD functionality (**GPIOAFSEL=1**, **GIODEN=1** and **GPIOPUR=1**). A Power-On-Reset ( $\overline{POR}$ ) or asserting  $\overline{RST}$  puts both groups of pins back to their default state.

**Caution – If the JTAG pins are used as GPIOs in a design, PB7 and PC2 cannot have external pull-down resistors connected to both of them at the same time. If both pins are pulled Low during reset, the controller has unpredictable behavior. If this happens, remove one or both of the pull-down resistors, and apply  $\overline{RST}$  or power-cycle the part.**

**In addition, it is possible to create a software sequence that prevents the debugger from connecting to the Stellaris<sup>®</sup> microcontroller. If the program code loaded into flash immediately changes the JTAG pins to their GPIO functionality, the debugger may not have enough time to connect and halt the controller before the JTAG pin functionality switches. This may lock the debugger out of the part. This can be avoided with a software routine that restores JTAG functionality based on an external or software trigger.**

### GPIO Alternate Function Select (GPIOAFSEL)

GPIO Port A base: 0x4000.4000  
 GPIO Port B base: 0x4000.5000  
 GPIO Port C base: 0x4000.6000  
 GPIO Port D base: 0x4000.7000  
 GPIO Port E base: 0x4002.4000  
 GPIO Port F base: 0x4002.5000  
 GPIO Port G base: 0x4002.6000  
 GPIO Port H base: 0x4002.7000  
 Offset 0x420  
 Type R/W, reset -

	31	30	29	28	27	26	25	24	23	22	21	20	19	18	17	16
	reserved															
Type	RO	RO	RO	RO	RO	RO	RO	RO	RO	RO	RO	RO	RO	RO	RO	RO
Reset	0	0	0	0	0	0	0	0	0	0	0	0	0	0	0	0
	15	14	13	12	11	10	9	8	7	6	5	4	3	2	1	0
	reserved								AFSEL							
Type	RO	RO	RO	RO	RO	RO	RO	RO	R/W	R/W	R/W	R/W	R/W	R/W	R/W	R/W
Reset	0	0	0	0	0	0	0	0	-	-	-	-	-	-	-	-

Bit/Field	Name	Type	Reset	Description
31:8	reserved	RO	0x00	Software should not rely on the value of a reserved bit. To provide compatibility with future products, the value of a reserved bit should be preserved across a read-modify-write operation.

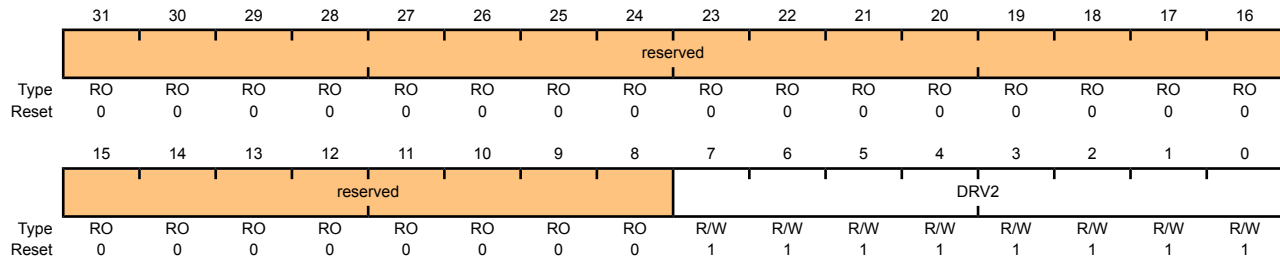
Bit/Field	Name	Type	Reset	Description						
7:0	AFSEL	R/W	-	<p>GPIO Alternate Function Select</p> <p>The AFSEL values are defined as follows:</p> <table><thead><tr><th>Value</th><th>Description</th></tr></thead><tbody><tr><td>0</td><td>Software control of corresponding GPIO line (GPIO mode).</td></tr><tr><td>1</td><td>Hardware control of corresponding GPIO line (alternate hardware function).</td></tr></tbody></table> <p><b>Note:</b> The default reset value for the <b>GPIOAFSEL</b>, <b>GPIOPUR</b>, and <b>GPIODEN</b> registers are 0x0000.0000 for all GPIO pins, with the exception of the five JTAG/SWD pins (PB7 and PC[3:0]). These five pins default to JTAG/SWD functionality. Because of this, the default reset value of these registers for GPIO Port B is 0x0000.0080 while the default reset value for Port C is 0x0000.000F.</p>	Value	Description	0	Software control of corresponding GPIO line (GPIO mode).	1	Hardware control of corresponding GPIO line (alternate hardware function).
Value	Description									
0	Software control of corresponding GPIO line (GPIO mode).									
1	Hardware control of corresponding GPIO line (alternate hardware function).									

### Register 11: GPIO 2-mA Drive Select (GPIODR2R), offset 0x500

The **GPIODR2R** register is the 2-mA drive control register. It allows for each GPIO signal in the port to be individually configured without affecting the other pads. When writing a **DRV2** bit for a GPIO signal, the corresponding **DRV4** bit in the **GPIODR4R** register and the **DRV8** bit in the **GPIODR8R** register are automatically cleared by hardware.

#### GPIO 2-mA Drive Select (GPIODR2R)

GPIO Port A base: 0x4000.4000  
 GPIO Port B base: 0x4000.5000  
 GPIO Port C base: 0x4000.6000  
 GPIO Port D base: 0x4000.7000  
 GPIO Port E base: 0x4002.4000  
 GPIO Port F base: 0x4002.5000  
 GPIO Port G base: 0x4002.6000  
 GPIO Port H base: 0x4002.7000  
 Offset 0x500  
 Type R/W, reset 0x0000.00FF



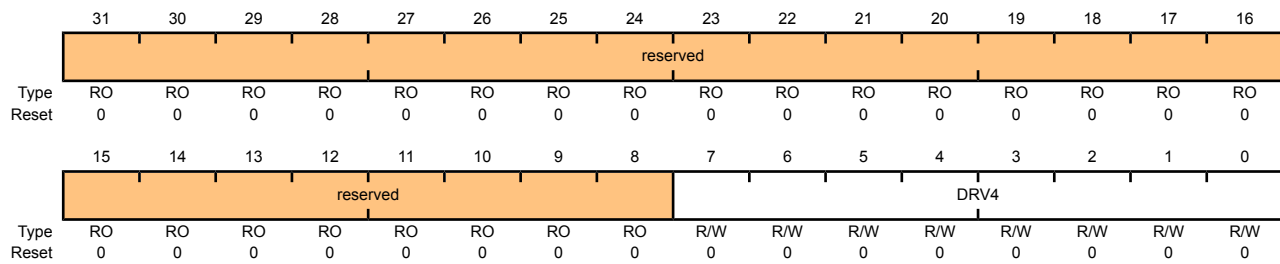
Bit/Field	Name	Type	Reset	Description
31:8	reserved	RO	0x00	Software should not rely on the value of a reserved bit. To provide compatibility with future products, the value of a reserved bit should be preserved across a read-modify-write operation.
7:0	DRV2	R/W	0xFF	Output Pad 2-mA Drive Enable  A write of 1 to either <b>GPIODR4[n]</b> or <b>GPIODR8[n]</b> clears the corresponding 2-mA enable bit. The change is effective on the second clock cycle after the write.

### Register 12: GPIO 4-mA Drive Select (GPIODR4R), offset 0x504

The **GPIODR4R** register is the 4-mA drive control register. It allows for each GPIO signal in the port to be individually configured without affecting the other pads. When writing the **DRV4** bit for a GPIO signal, the corresponding **DRV2** bit in the **GPIODR2R** register and the **DRV8** bit in the **GPIODR8R** register are automatically cleared by hardware.

#### GPIO 4-mA Drive Select (GPIODR4R)

GPIO Port A base: 0x4000.4000  
 GPIO Port B base: 0x4000.5000  
 GPIO Port C base: 0x4000.6000  
 GPIO Port D base: 0x4000.7000  
 GPIO Port E base: 0x4002.4000  
 GPIO Port F base: 0x4002.5000  
 GPIO Port G base: 0x4002.6000  
 GPIO Port H base: 0x4002.7000  
 Offset 0x504  
 Type R/W, reset 0x0000.0000



Bit/Field	Name	Type	Reset	Description
31:8	reserved	RO	0x00	Software should not rely on the value of a reserved bit. To provide compatibility with future products, the value of a reserved bit should be preserved across a read-modify-write operation.
7:0	DRV4	R/W	0x00	Output Pad 4-mA Drive Enable  A write of 1 to either <b>GPIODR2[n]</b> or <b>GPIODR8[n]</b> clears the corresponding 4-mA enable bit. The change is effective on the second clock cycle after the write.



### Register 13: GPIO 8-mA Drive Select (GPIODR8R), offset 0x508

The **GPIODR8R** register is the 8-mA drive control register. It allows for each GPIO signal in the port to be individually configured without affecting the other pads. When writing the **DRV8** bit for a GPIO signal, the corresponding **DRV2** bit in the **GPIODR2R** register and the **DRV4** bit in the **GPIODR4R** register are automatically cleared by hardware.

#### GPIO 8-mA Drive Select (GPIODR8R)

GPIO Port A base: 0x4000.4000

GPIO Port B base: 0x4000.5000

GPIO Port C base: 0x4000.6000

GPIO Port D base: 0x4000.7000

GPIO Port E base: 0x4002.4000

GPIO Port F base: 0x4002.5000

GPIO Port G base: 0x4002.6000

GPIO Port H base: 0x4002.7000

Offset 0x508

Type R/W, reset 0x0000.0000

	31	30	29	28	27	26	25	24	23	22	21	20	19	18	17	16
	reserved															
Type	RO	RO	RO	RO	RO	RO	RO	RO	RO	RO	RO	RO	RO	RO	RO	RO
Reset	0	0	0	0	0	0	0	0	0	0	0	0	0	0	0	0
	15	14	13	12	11	10	9	8	7	6	5	4	3	2	1	0
	reserved								DRV8							
Type	RO	RO	RO	RO	RO	RO	RO	RO	R/W	R/W	R/W	R/W	R/W	R/W	R/W	R/W
Reset	0	0	0	0	0	0	0	0	0	0	0	0	0	0	0	0

Bit/Field	Name	Type	Reset	Description
31:8	reserved	RO	0x00	Software should not rely on the value of a reserved bit. To provide compatibility with future products, the value of a reserved bit should be preserved across a read-modify-write operation.
7:0	DRV8	R/W	0x00	Output Pad 8-mA Drive Enable  A write of 1 to either <b>GPIODR2[n]</b> or <b>GPIODR4[n]</b> clears the corresponding 8-mA enable bit. The change is effective on the second clock cycle after the write.

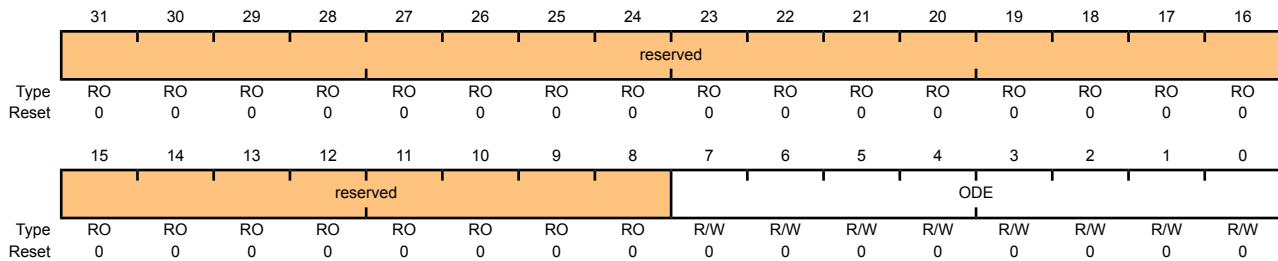
### Register 14: GPIO Open Drain Select (GPIOODR), offset 0x50C

The **GPIOODR** register is the open drain control register. Setting a bit in this register enables the open drain configuration of the corresponding GPIO pad. When open drain mode is enabled, the corresponding bit should also be set in the **GPIO Digital Input Enable (GPIODEN)** register (see page 182). Corresponding bits in the drive strength registers (**GPIODR2R**, **GPIODR4R**, **GPIODR8R**, and **GPIOSLR**) can be set to achieve the desired rise and fall times. The GPIO acts as an open drain input if the corresponding bit in the **GPIODIR** register is set to 0; and as an open drain output when set to 1.

When using the I<sup>2</sup>C module, the **GPIO Alternate Function Select (GPIOAFSEL)** register bit for PB2 and PB3 should be set to 1 (see examples in “Initialization and Configuration” on page 160).

#### GPIO Open Drain Select (GPIOODR)

GPIO Port A base: 0x4000.4000  
 GPIO Port B base: 0x4000.5000  
 GPIO Port C base: 0x4000.6000  
 GPIO Port D base: 0x4000.7000  
 GPIO Port E base: 0x4002.4000  
 GPIO Port F base: 0x4002.5000  
 GPIO Port G base: 0x4002.6000  
 GPIO Port H base: 0x4002.7000  
 Offset 0x50C  
 Type R/W, reset 0x0000.0000



Bit/Field	Name	Type	Reset	Description
31:8	reserved	RO	0x00	Software should not rely on the value of a reserved bit. To provide compatibility with future products, the value of a reserved bit should be preserved across a read-modify-write operation.
7:0	ODE	R/W	0x00	Output Pad Open Drain Enable

The **ODE** values are defined as follows:

Value	Description
0	Open drain configuration is disabled.
1	Open drain configuration is enabled.

## Register 15: GPIO Pull-Up Select (GPIOPUR), offset 0x510

The **GPIOPUR** register is the pull-up control register. When a bit is set to 1, it enables a weak pull-up resistor on the corresponding GPIO signal. Setting a bit in **GPIOPUR** automatically clears the corresponding bit in the **GPIO Pull-Down Select (GPIOPDR)** register (see page 180).

### GPIO Pull-Up Select (GPIOPUR)

GPIO Port A base: 0x4000.4000  
 GPIO Port B base: 0x4000.5000  
 GPIO Port C base: 0x4000.6000  
 GPIO Port D base: 0x4000.7000  
 GPIO Port E base: 0x4002.4000  
 GPIO Port F base: 0x4002.5000  
 GPIO Port G base: 0x4002.6000  
 GPIO Port H base: 0x4002.7000  
 Offset 0x510

Type R/W, reset -

	31	30	29	28	27	26	25	24	23	22	21	20	19	18	17	16
	reserved															
Type	RO	RO	RO	RO	RO	RO	RO	RO	RO	RO	RO	RO	RO	RO	RO	RO
Reset	0	0	0	0	0	0	0	0	0	0	0	0	0	0	0	0
	15	14	13	12	11	10	9	8	7	6	5	4	3	2	1	0
	reserved								PUE							
Type	RO	RO	RO	RO	RO	RO	RO	RO	R/W	R/W	R/W	R/W	R/W	R/W	R/W	R/W
Reset	0	0	0	0	0	0	0	0	-	-	-	-	-	-	-	-

Bit/Field	Name	Type	Reset	Description
31:8	reserved	RO	0x00	Software should not rely on the value of a reserved bit. To provide compatibility with future products, the value of a reserved bit should be preserved across a read-modify-write operation.
7:0	PUE	R/W	-	Pad Weak Pull-Up Enable

A write of 1 to **GPIOPDR[n]** clears the corresponding **GPIOPUR[n]** enables. The change is effective on the second clock cycle after the write.

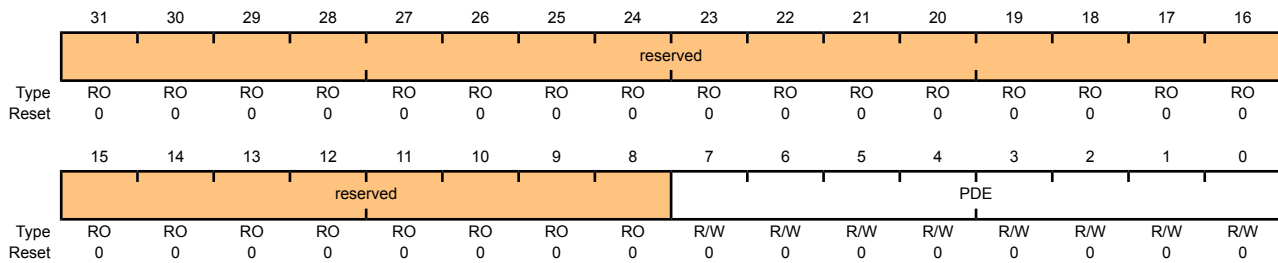
**Note:** The default reset value for the **GPIOAFSEL**, **GPIOPUR**, and **GIODEN** registers are 0x0000.0000 for all GPIO pins, with the exception of the five JTAG/SWD pins (**PB7** and **PC[3:0]**). These five pins default to JTAG/SWD functionality. Because of this, the default reset value of these registers for GPIO Port B is 0x0000.0080 while the default reset value for Port C is 0x0000.000F.

### Register 16: GPIO Pull-Down Select (GPIOPDR), offset 0x514

The **GPIOPDR** register is the pull-down control register. When a bit is set to 1, it enables a weak pull-down resistor on the corresponding GPIO signal. Setting a bit in **GPIOPDR** automatically clears the corresponding bit in the **GPIO Pull-Up Select (GPIOPUR)** register (see page 179).

#### GPIO Pull-Down Select (GPIOPDR)

GPIO Port A base: 0x4000.4000  
 GPIO Port B base: 0x4000.5000  
 GPIO Port C base: 0x4000.6000  
 GPIO Port D base: 0x4000.7000  
 GPIO Port E base: 0x4002.4000  
 GPIO Port F base: 0x4002.5000  
 GPIO Port G base: 0x4002.6000  
 GPIO Port H base: 0x4002.7000  
 Offset 0x514  
 Type R/W, reset 0x0000.0000



Bit/Field	Name	Type	Reset	Description
31:8	reserved	RO	0x00	Software should not rely on the value of a reserved bit. To provide compatibility with future products, the value of a reserved bit should be preserved across a read-modify-write operation.
7:0	PDE	R/W	0x00	Pad Weak Pull-Down Enable  A write of 1 to <b>GPIOPUR[n]</b> clears the corresponding <b>GPIOPDR[n]</b> enables. The change is effective on the second clock cycle after the write.

## Register 17: GPIO Slew Rate Control Select (GPIOSLR), offset 0x518

The **GPIOSLR** register is the slew rate control register. Slew rate control is only available when using the 8-mA drive strength option via the **GPIO 8-mA Drive Select (GPIO8R)** register (see page 177).

### GPIO Slew Rate Control Select (GPIOSLR)

GPIO Port A base: 0x4000.4000  
 GPIO Port B base: 0x4000.5000  
 GPIO Port C base: 0x4000.6000  
 GPIO Port D base: 0x4000.7000  
 GPIO Port E base: 0x4002.4000  
 GPIO Port F base: 0x4002.5000  
 GPIO Port G base: 0x4002.6000  
 GPIO Port H base: 0x4002.7000  
 Offset 0x518  
 Type R/W, reset 0x0000.0000

	31	30	29	28	27	26	25	24	23	22	21	20	19	18	17	16
	reserved															
Type	RO	RO	RO	RO	RO	RO	RO	RO	RO	RO	RO	RO	RO	RO	RO	RO
Reset	0	0	0	0	0	0	0	0	0	0	0	0	0	0	0	0
	15	14	13	12	11	10	9	8	7	6	5	4	3	2	1	0
	reserved								SRL							
Type	RO	RO	RO	RO	RO	RO	RO	RO	R/W	R/W	R/W	R/W	R/W	R/W	R/W	R/W
Reset	0	0	0	0	0	0	0	0	0	0	0	0	0	0	0	0

Bit/Field	Name	Type	Reset	Description
31:8	reserved	RO	0x00	Software should not rely on the value of a reserved bit. To provide compatibility with future products, the value of a reserved bit should be preserved across a read-modify-write operation.
7:0	SRL	R/W	0x00	Slew Rate Limit Enable (8-mA drive only)

The **SRL** values are defined as follows:

Value	Description
0	Slew rate control disabled.
1	Slew rate control enabled.

### Register 18: GPIO Digital Enable (GPIODEN), offset 0x51C

The **GPIODEN** register is the digital enable register. By default, with the exception of the GPIO signals used for JTAG/SWD function, all other GPIO signals are configured out of reset to be undriven (tristate). Their digital function is disabled; they do not drive a logic value on the pin and they do not allow the pin voltage into the GPIO receiver. To use the pin in a digital function (either GPIO or alternate function), the corresponding **GPIODEN** bit must be set.

#### GPIO Digital Enable (GPIODEN)

GPIO Port A base: 0x4000.4000  
 GPIO Port B base: 0x4000.5000  
 GPIO Port C base: 0x4000.6000  
 GPIO Port D base: 0x4000.7000  
 GPIO Port E base: 0x4002.4000  
 GPIO Port F base: 0x4002.5000  
 GPIO Port G base: 0x4002.6000  
 GPIO Port H base: 0x4002.7000  
 Offset 0x51C  
 Type R/W, reset -

	31	30	29	28	27	26	25	24	23	22	21	20	19	18	17	16
	reserved															
Type	RO	RO	RO	RO	RO	RO	RO	RO	RO	RO	RO	RO	RO	RO	RO	RO
Reset	0	0	0	0	0	0	0	0	0	0	0	0	0	0	0	0
	15	14	13	12	11	10	9	8	7	6	5	4	3	2	1	0
	reserved								DEN							
Type	RO	RO	RO	RO	RO	RO	RO	RO	R/W	R/W	R/W	R/W	R/W	R/W	R/W	R/W
Reset	0	0	0	0	0	0	0	0	-	-	-	-	-	-	-	-

Bit/Field	Name	Type	Reset	Description
31:8	reserved	RO	0x00	Software should not rely on the value of a reserved bit. To provide compatibility with future products, the value of a reserved bit should be preserved across a read-modify-write operation.
7:0	DEN	R/W	-	Digital Enable

The **DEN** values are defined as follows:

Value	Description
0	Digital functions disabled.
1	Digital functions enabled.

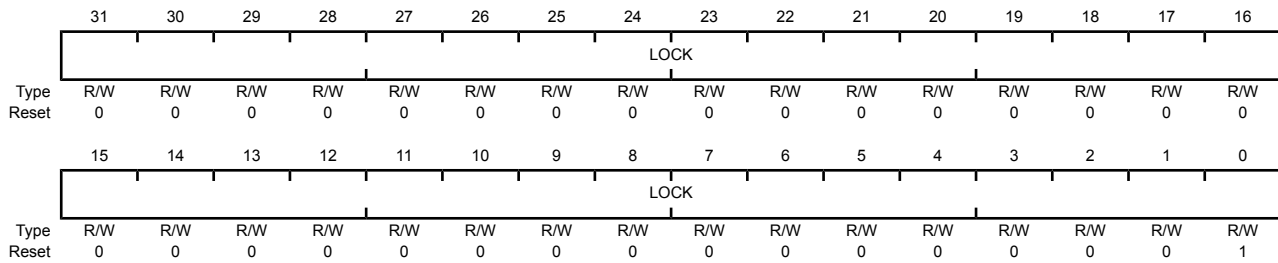
**Note:** The default reset value for the **GPIOAFSEL**, **GPIOPUR**, and **GPIODEN** registers are 0x0000.0000 for all GPIO pins, with the exception of the five JTAG/SWD pins (**PB7** and **PC[3:0]**). These five pins default to JTAG/SWD functionality. Because of this, the default reset value of these registers for GPIO Port B is 0x0000.0080 while the default reset value for Port C is 0x0000.000F.

### Register 19: GPIO Lock (GPIOLOCK), offset 0x520

The **GPIOLOCK** register enables write access to the **GPIOCR** register (see page 184). Writing 0x1ACCE551 to the **GPIOLOCK** register will unlock the **GPIOCR** register. Writing any other value to the **GPIOLOCK** register re-enables the locked state. Reading the **GPIOLOCK** register returns the lock status rather than the 32-bit value that was previously written. Therefore, when write accesses are disabled, or locked, reading the **GPIOLOCK** register returns 0x00000001. When write accesses are enabled, or unlocked, reading the **GPIOLOCK** register returns 0x00000000.

#### GPIO Lock (GPIOLOCK)

GPIO Port A base: 0x4000.4000  
 GPIO Port B base: 0x4000.5000  
 GPIO Port C base: 0x4000.6000  
 GPIO Port D base: 0x4000.7000  
 GPIO Port E base: 0x4002.4000  
 GPIO Port F base: 0x4002.5000  
 GPIO Port G base: 0x4002.6000  
 GPIO Port H base: 0x4002.7000  
 Offset 0x520  
 Type R/W, reset 0x0000.0001



Bit/Field	Name	Type	Reset	Description
31:0	LOCK	R/W	0x0000.0001	GPIO Lock

A write of the value 0x1ACCE551 unlocks the **GPIO Commit (GPIOCR)** register for write access. A write of any other value reapplies the lock, preventing any register updates. A read of this register returns the following values:

Value	Description
0x0000.0001	locked
0x0000.0000	unlocked

### Register 20: GPIO Commit (GPIOCR), offset 0x524

The **GPIOCR** register is the commit register. The value of the **GPIOCR** register determines which bits of the **GPIOAFSEL** register will be committed when a write to the **GPIOAFSEL** register is performed. If a bit in the **GPIOCR** register is a zero, the data being written to the corresponding bit in the **GPIOAFSEL** register will not be committed and will retain its previous value. If a bit in the **GPIOCR** register is a one, the data being written to the corresponding bit of the **GPIOAFSEL** register will be committed to the register and will reflect the new value.

The contents of the **GPIOCR** register can only be modified if the **GPIOLOCK** register is unlocked. Writes to the **GPIOCR** register will be ignored if the **GPIOLOCK** register is locked.

**Important:** This register is designed to prevent accidental programming of the **GPIOAFSEL** registers that control connectivity to the JTAG/SWD debug hardware. By initializing the bits of the **GPIOCR** register to 0 for **PB7** and **PC[3:0]**, the JTAG/SWD debug port can only be converted to GPIOs through a deliberate set of writes to the **GPIOLOCK**, **GPIOCR**, and **GPIOAFSEL** registers.

Because this protection is currently only implemented on the JTAG/SWD pins on **PB7** and **PC[3:0]**, all of the other bits in the **GPIOCR** registers cannot be written with 0x0. These bits are hardwired to 0x1, ensuring that it is always possible to commit new values to the **GPIOAFSEL** register bits of these other pins.

#### GPIO Commit (GPIOCR)

GPIO Port A base: 0x4000.4000  
 GPIO Port B base: 0x4000.5000  
 GPIO Port C base: 0x4000.6000  
 GPIO Port D base: 0x4000.7000  
 GPIO Port E base: 0x4002.4000  
 GPIO Port F base: 0x4002.5000  
 GPIO Port G base: 0x4002.6000  
 GPIO Port H base: 0x4002.7000  
 Offset 0x524  
 Type -, reset -

	31	30	29	28	27	26	25	24	23	22	21	20	19	18	17	16
	reserved															
Type	RO	RO	RO	RO	RO	RO	RO	RO	RO	RO	RO	RO	RO	RO	RO	RO
Reset	0	0	0	0	0	0	0	0	0	0	0	0	0	0	0	0
	15	14	13	12	11	10	9	8	7	6	5	4	3	2	1	0
	reserved								CR							
Type	RO	RO	RO	RO	RO	RO	RO	RO	-	-	-	-	-	-	-	-
Reset	0	0	0	0	0	0	0	0	-	-	-	-	-	-	-	-

Bit/Field	Name	Type	Reset	Description
31:8	reserved	RO	0x00	Software should not rely on the value of a reserved bit. To provide compatibility with future products, the value of a reserved bit should be preserved across a read-modify-write operation.



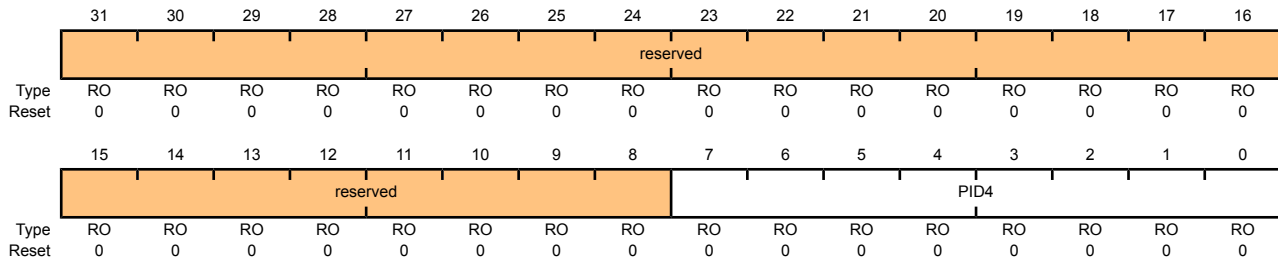
Bit/Field	Name	Type	Reset	Description
7:0	CR	-	-	<p>GPIO Commit</p> <p>On a bit-wise basis, any bit set allows the corresponding <code>GPIOAFSEL</code> bit to be set to its alternate function.</p> <p><b>Note:</b> The default register type for the <b>GPIOCR</b> register is RO for all GPIO pins, with the exception of the five JTAG/SWD pins (<code>PB7</code> and <code>PC[3:0]</code>). These five pins are currently the only GPIOs that are protected by the <b>GPIOCR</b> register. Because of this, the register type for GPIO Port B7 and GPIO Port C[3:0] is R/W.</p> <p>The default reset value for the <b>GPIOCR</b> register is 0x0000.00FF for all GPIO pins, with the exception of the five JTAG/SWD pins (<code>PB7</code> and <code>PC[3:0]</code>). To ensure that the JTAG port is not accidentally programmed as a GPIO, these five pins default to non-commitable. Because of this, the default reset value of <b>GPIOCR</b> for GPIO Port B is 0x0000.007F while the default reset value of <b>GPIOCR</b> for Port C is 0x0000.00F0.</p>

**Register 21: GPIO Peripheral Identification 4 (GPIOPeriphID4), offset 0xFD0**

The **GPIOPeriphID4**, **GPIOPeriphID5**, **GPIOPeriphID6**, and **GPIOPeriphID7** registers can conceptually be treated as one 32-bit register; each register contains eight bits of the 32-bit register, used by software to identify the peripheral.

GPIO Peripheral Identification 4 (GPIOPeriphID4)

GPIO Port A base: 0x4000.4000  
 GPIO Port B base: 0x4000.5000  
 GPIO Port C base: 0x4000.6000  
 GPIO Port D base: 0x4000.7000  
 GPIO Port E base: 0x4002.4000  
 GPIO Port F base: 0x4002.5000  
 GPIO Port G base: 0x4002.6000  
 GPIO Port H base: 0x4002.7000  
 Offset 0xFD0  
 Type RO, reset 0x0000.0000



Bit/Field	Name	Type	Reset	Description
31:8	reserved	RO	0x00	Software should not rely on the value of a reserved bit. To provide compatibility with future products, the value of a reserved bit should be preserved across a read-modify-write operation.
7:0	PID4	RO	0x00	GPIO Peripheral ID Register[7:0]

**Register 22: GPIO Peripheral Identification 5 (GPIOPeriphID5), offset 0xFD4**

The **GPIOPeriphID4**, **GPIOPeriphID5**, **GPIOPeriphID6**, and **GPIOPeriphID7** registers can conceptually be treated as one 32-bit register; each register contains eight bits of the 32-bit register, used by software to identify the peripheral.

## GPIO Peripheral Identification 5 (GPIOPeriphID5)

GPIO Port A base: 0x4000.4000

GPIO Port B base: 0x4000.5000

GPIO Port C base: 0x4000.6000

GPIO Port D base: 0x4000.7000

GPIO Port E base: 0x4002.4000

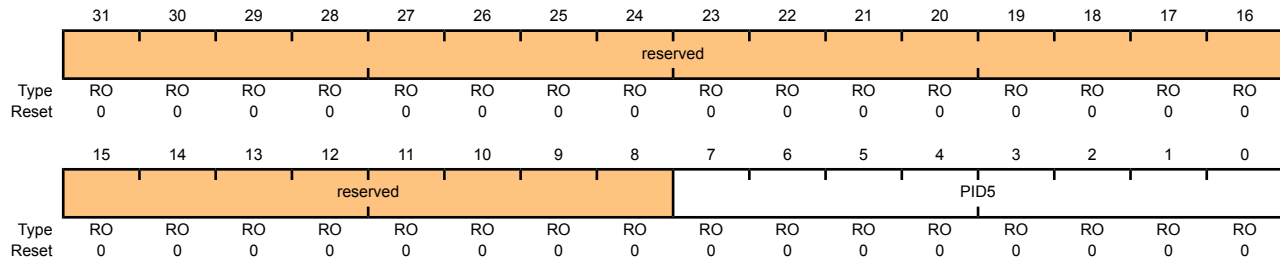
GPIO Port F base: 0x4002.5000

GPIO Port G base: 0x4002.6000

GPIO Port H base: 0x4002.7000

Offset 0xFD4

Type RO, reset 0x0000.0000



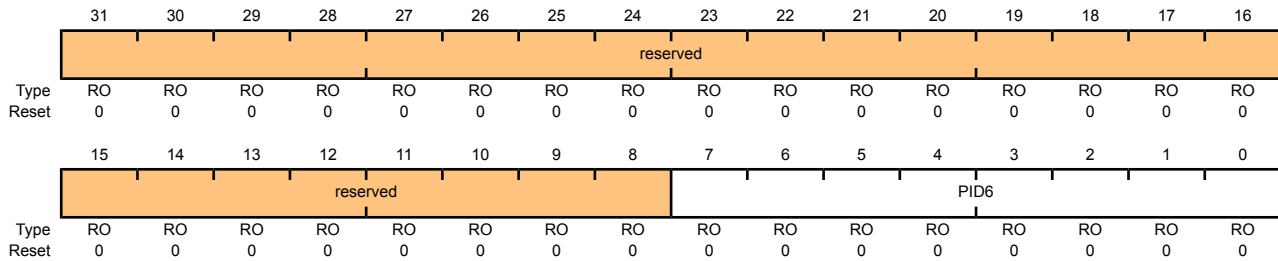
Bit/Field	Name	Type	Reset	Description
31:8	reserved	RO	0x00	Software should not rely on the value of a reserved bit. To provide compatibility with future products, the value of a reserved bit should be preserved across a read-modify-write operation.
7:0	PID5	RO	0x00	GPIO Peripheral ID Register[15:8]

**Register 23: GPIO Peripheral Identification 6 (GPIOPeriphID6), offset 0xFD8**

The **GPIOPeriphID4**, **GPIOPeriphID5**, **GPIOPeriphID6**, and **GPIOPeriphID7** registers can conceptually be treated as one 32-bit register; each register contains eight bits of the 32-bit register, used by software to identify the peripheral.

GPIO Peripheral Identification 6 (GPIOPeriphID6)

GPIO Port A base: 0x4000.4000  
 GPIO Port B base: 0x4000.5000  
 GPIO Port C base: 0x4000.6000  
 GPIO Port D base: 0x4000.7000  
 GPIO Port E base: 0x4002.4000  
 GPIO Port F base: 0x4002.5000  
 GPIO Port G base: 0x4002.6000  
 GPIO Port H base: 0x4002.7000  
 Offset 0xFD8  
 Type RO, reset 0x0000.0000



Bit/Field	Name	Type	Reset	Description
31:8	reserved	RO	0x00	Software should not rely on the value of a reserved bit. To provide compatibility with future products, the value of a reserved bit should be preserved across a read-modify-write operation.
7:0	PID6	RO	0x00	GPIO Peripheral ID Register[23:16]

**Register 24: GPIO Peripheral Identification 7 (GPIOPeriphID7), offset 0xFDC**

The **GPIOPeriphID4**, **GPIOPeriphID5**, **GPIOPeriphID6**, and **GPIOPeriphID7** registers can conceptually be treated as one 32-bit register; each register contains eight bits of the 32-bit register, used by software to identify the peripheral.

## GPIO Peripheral Identification 7 (GPIOPeriphID7)

GPIO Port A base: 0x4000.4000

GPIO Port B base: 0x4000.5000

GPIO Port C base: 0x4000.6000

GPIO Port D base: 0x4000.7000

GPIO Port E base: 0x4002.4000

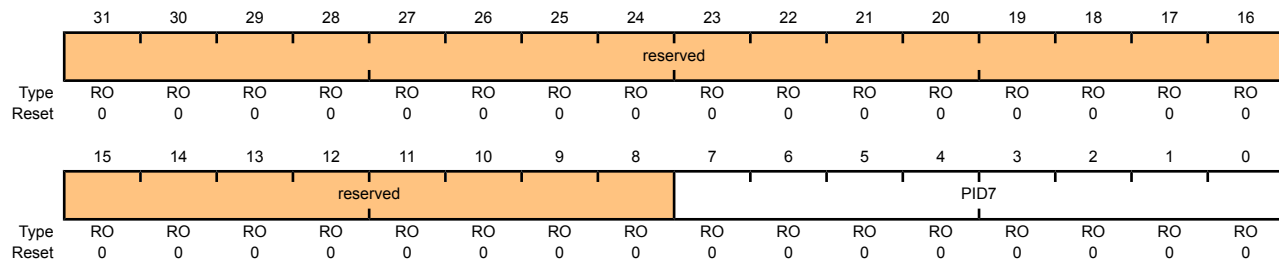
GPIO Port F base: 0x4002.5000

GPIO Port G base: 0x4002.6000

GPIO Port H base: 0x4002.7000

Offset 0xFDC

Type RO, reset 0x0000.0000



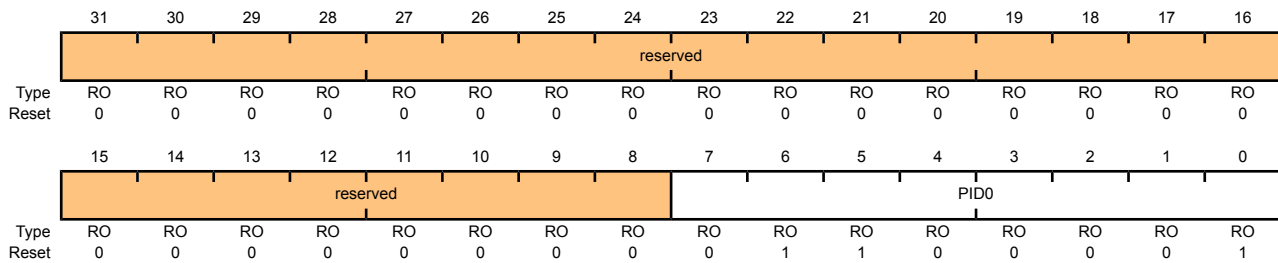
Bit/Field	Name	Type	Reset	Description
31:8	reserved	RO	0x00	Software should not rely on the value of a reserved bit. To provide compatibility with future products, the value of a reserved bit should be preserved across a read-modify-write operation.
7:0	PID7	RO	0x00	GPIO Peripheral ID Register[31:24]

### Register 25: GPIO Peripheral Identification 0 (GPIOPeriphID0), offset 0xFE0

The **GPIOPeriphID0**, **GPIOPeriphID1**, **GPIOPeriphID2**, and **GPIOPeriphID3** registers can conceptually be treated as one 32-bit register; each register contains eight bits of the 32-bit register, used by software to identify the peripheral.

#### GPIO Peripheral Identification 0 (GPIOPeriphID0)

GPIO Port A base: 0x4000.4000  
 GPIO Port B base: 0x4000.5000  
 GPIO Port C base: 0x4000.6000  
 GPIO Port D base: 0x4000.7000  
 GPIO Port E base: 0x4002.4000  
 GPIO Port F base: 0x4002.5000  
 GPIO Port G base: 0x4002.6000  
 GPIO Port H base: 0x4002.7000  
 Offset 0xFE0  
 Type RO, reset 0x0000.0061



Bit/Field	Name	Type	Reset	Description
31:8	reserved	RO	0x00	Software should not rely on the value of a reserved bit. To provide compatibility with future products, the value of a reserved bit should be preserved across a read-modify-write operation.
7:0	PID0	RO	0x61	GPIO Peripheral ID Register[7:0]  Can be used by software to identify the presence of this peripheral.

**Register 26: GPIO Peripheral Identification 1 (GPIOPeriphID1), offset 0xFE4**

The **GPIOPeriphID0**, **GPIOPeriphID1**, **GPIOPeriphID2**, and **GPIOPeriphID3** registers can conceptually be treated as one 32-bit register; each register contains eight bits of the 32-bit register, used by software to identify the peripheral.

## GPIO Peripheral Identification 1 (GPIOPeriphID1)

GPIO Port A base: 0x4000.4000

GPIO Port B base: 0x4000.5000

GPIO Port C base: 0x4000.6000

GPIO Port D base: 0x4000.7000

GPIO Port E base: 0x4002.4000

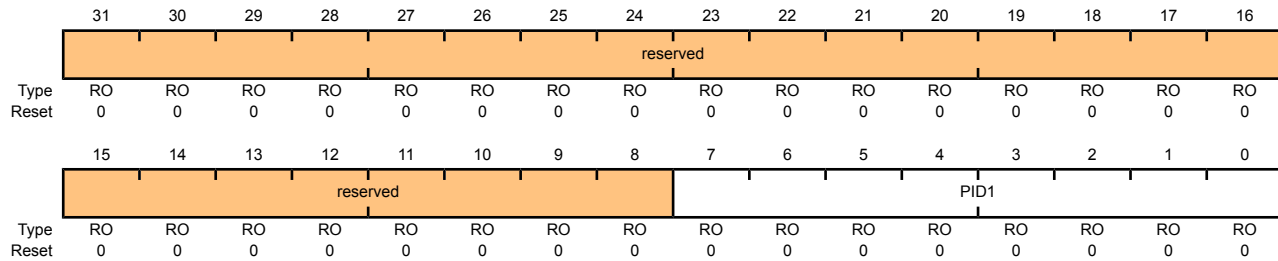
GPIO Port F base: 0x4002.5000

GPIO Port G base: 0x4002.6000

GPIO Port H base: 0x4002.7000

Offset 0xFE4

Type RO, reset 0x0000.0000



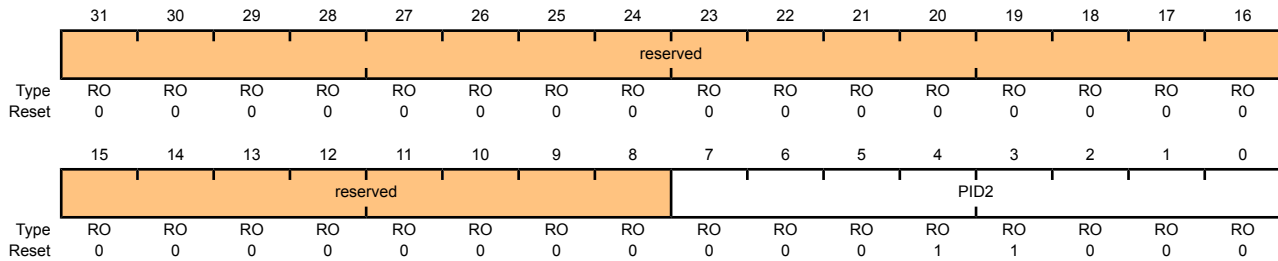
Bit/Field	Name	Type	Reset	Description
31:8	reserved	RO	0x00	Software should not rely on the value of a reserved bit. To provide compatibility with future products, the value of a reserved bit should be preserved across a read-modify-write operation.
7:0	PID1	RO	0x00	GPIO Peripheral ID Register[15:8] Can be used by software to identify the presence of this peripheral.

### Register 27: GPIO Peripheral Identification 2 (GPIOPeriphID2), offset 0xFE8

The **GPIOPeriphID0**, **GPIOPeriphID1**, **GPIOPeriphID2**, and **GPIOPeriphID3** registers can conceptually be treated as one 32-bit register; each register contains eight bits of the 32-bit register, used by software to identify the peripheral.

#### GPIO Peripheral Identification 2 (GPIOPeriphID2)

GPIO Port A base: 0x4000.4000  
 GPIO Port B base: 0x4000.5000  
 GPIO Port C base: 0x4000.6000  
 GPIO Port D base: 0x4000.7000  
 GPIO Port E base: 0x4002.4000  
 GPIO Port F base: 0x4002.5000  
 GPIO Port G base: 0x4002.6000  
 GPIO Port H base: 0x4002.7000  
 Offset 0xFE8  
 Type RO, reset 0x0000.0018



Bit/Field	Name	Type	Reset	Description
31:8	reserved	RO	0x00	Software should not rely on the value of a reserved bit. To provide compatibility with future products, the value of a reserved bit should be preserved across a read-modify-write operation.
7:0	PID2	RO	0x18	GPIO Peripheral ID Register[23:16]  Can be used by software to identify the presence of this peripheral.



**Register 28: GPIO Peripheral Identification 3 (GPIOPeriphID3), offset 0xFEC**

The **GPIOPeriphID0**, **GPIOPeriphID1**, **GPIOPeriphID2**, and **GPIOPeriphID3** registers can conceptually be treated as one 32-bit register; each register contains eight bits of the 32-bit register, used by software to identify the peripheral.

## GPIO Peripheral Identification 3 (GPIOPeriphID3)

GPIO Port A base: 0x4000.4000

GPIO Port B base: 0x4000.5000

GPIO Port C base: 0x4000.6000

GPIO Port D base: 0x4000.7000

GPIO Port E base: 0x4002.4000

GPIO Port F base: 0x4002.5000

GPIO Port G base: 0x4002.6000

GPIO Port H base: 0x4002.7000

Offset 0xFEC

Type RO, reset 0x0000.0001

	31	30	29	28	27	26	25	24	23	22	21	20	19	18	17	16
	reserved															
Type	RO	RO	RO	RO	RO	RO	RO	RO	RO	RO	RO	RO	RO	RO	RO	RO
Reset	0	0	0	0	0	0	0	0	0	0	0	0	0	0	0	0
	15	14	13	12	11	10	9	8	7	6	5	4	3	2	1	0
	reserved								PID3							
Type	RO	RO	RO	RO	RO	RO	RO	RO	RO	RO	RO	RO	RO	RO	RO	RO
Reset	0	0	0	0	0	0	0	0	0	0	0	0	0	0	0	1

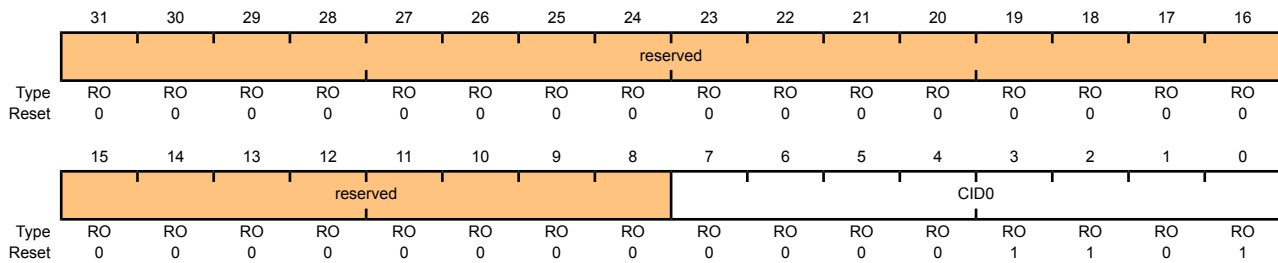
Bit/Field	Name	Type	Reset	Description
31:8	reserved	RO	0x00	Software should not rely on the value of a reserved bit. To provide compatibility with future products, the value of a reserved bit should be preserved across a read-modify-write operation.
7:0	PID3	RO	0x01	GPIO Peripheral ID Register[31:24] Can be used by software to identify the presence of this peripheral.

### Register 29: GPIO PrimeCell Identification 0 (GPIOCellID0), offset 0xFF0

The **GPIOCellID0**, **GPIOCellID1**, **GPIOCellID2**, and **GPIOCellID3** registers are four 8-bit wide registers, that can conceptually be treated as one 32-bit register. The register is used as a standard cross-peripheral identification system.

#### GPIO PrimeCell Identification 0 (GPIOCellID0)

GPIO Port A base: 0x4000.4000  
 GPIO Port B base: 0x4000.5000  
 GPIO Port C base: 0x4000.6000  
 GPIO Port D base: 0x4000.7000  
 GPIO Port E base: 0x4002.4000  
 GPIO Port F base: 0x4002.5000  
 GPIO Port G base: 0x4002.6000  
 GPIO Port H base: 0x4002.7000  
 Offset 0xFF0  
 Type RO, reset 0x0000.000D



Bit/Field	Name	Type	Reset	Description
31:8	reserved	RO	0x00	Software should not rely on the value of a reserved bit. To provide compatibility with future products, the value of a reserved bit should be preserved across a read-modify-write operation.
7:0	CID0	RO	0x0D	GPIO PrimeCell ID Register[7:0] Provides software a standard cross-peripheral identification system.

### Register 30: GPIO PrimeCell Identification 1 (GPIOCellID1), offset 0xFF4

The **GPIOCellID0**, **GPIOCellID1**, **GPIOCellID2**, and **GPIOCellID3** registers are four 8-bit wide registers, that can conceptually be treated as one 32-bit register. The register is used as a standard cross-peripheral identification system.

#### GPIO PrimeCell Identification 1 (GPIOCellID1)

GPIO Port A base: 0x4000.4000

GPIO Port B base: 0x4000.5000

GPIO Port C base: 0x4000.6000

GPIO Port D base: 0x4000.7000

GPIO Port E base: 0x4002.4000

GPIO Port F base: 0x4002.5000

GPIO Port G base: 0x4002.6000

GPIO Port H base: 0x4002.7000

Offset 0xFF4

Type RO, reset 0x0000.00F0

	31	30	29	28	27	26	25	24	23	22	21	20	19	18	17	16
	reserved															
Type	RO	RO	RO	RO	RO	RO	RO	RO	RO	RO	RO	RO	RO	RO	RO	RO
Reset	0	0	0	0	0	0	0	0	0	0	0	0	0	0	0	0
	15	14	13	12	11	10	9	8	7	6	5	4	3	2	1	0
	reserved								CID1							
Type	RO	RO	RO	RO	RO	RO	RO	RO	RO	RO	RO	RO	RO	RO	RO	RO
Reset	0	0	0	0	0	0	0	0	1	1	1	1	0	0	0	0

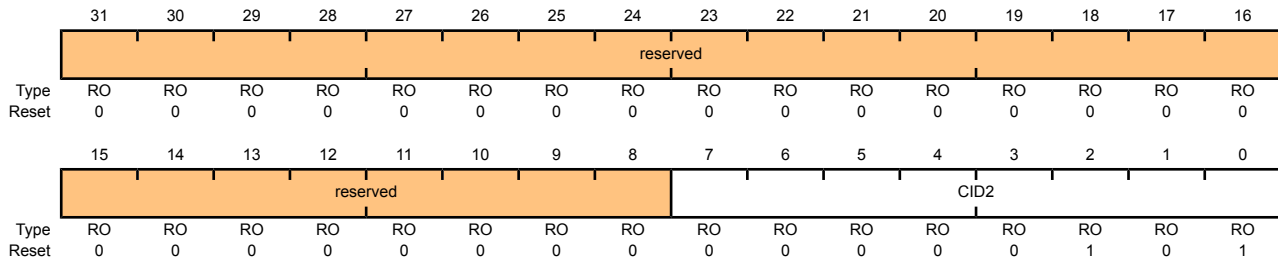
Bit/Field	Name	Type	Reset	Description
31:8	reserved	RO	0x00	Software should not rely on the value of a reserved bit. To provide compatibility with future products, the value of a reserved bit should be preserved across a read-modify-write operation.
7:0	CID1	RO	0xF0	GPIO PrimeCell ID Register[15:8] Provides software a standard cross-peripheral identification system.

**Register 31: GPIO PrimeCell Identification 2 (GPIOCellID2), offset 0xFF8**

The **GPIOCellID0**, **GPIOCellID1**, **GPIOCellID2**, and **GPIOCellID3** registers are four 8-bit wide registers, that can conceptually be treated as one 32-bit register. The register is used as a standard cross-peripheral identification system.

GPIO PrimeCell Identification 2 (GPIOCellID2)

GPIO Port A base: 0x4000.4000  
 GPIO Port B base: 0x4000.5000  
 GPIO Port C base: 0x4000.6000  
 GPIO Port D base: 0x4000.7000  
 GPIO Port E base: 0x4002.4000  
 GPIO Port F base: 0x4002.5000  
 GPIO Port G base: 0x4002.6000  
 GPIO Port H base: 0x4002.7000  
 Offset 0xFF8  
 Type RO, reset 0x0000.0005



Bit/Field	Name	Type	Reset	Description
31:8	reserved	RO	0x00	Software should not rely on the value of a reserved bit. To provide compatibility with future products, the value of a reserved bit should be preserved across a read-modify-write operation.
7:0	CID2	RO	0x05	GPIO PrimeCell ID Register[23:16] Provides software a standard cross-peripheral identification system.

## Register 32: GPIO PrimeCell Identification 3 (GPIOCellID3), offset 0xFFC

The **GPIOCellID0**, **GPIOCellID1**, **GPIOCellID2**, and **GPIOCellID3** registers are four 8-bit wide registers, that can conceptually be treated as one 32-bit register. The register is used as a standard cross-peripheral identification system.

### GPIO PrimeCell Identification 3 (GPIOCellID3)

GPIO Port A base: 0x4000.4000

GPIO Port B base: 0x4000.5000

GPIO Port C base: 0x4000.6000

GPIO Port D base: 0x4000.7000

GPIO Port E base: 0x4002.4000

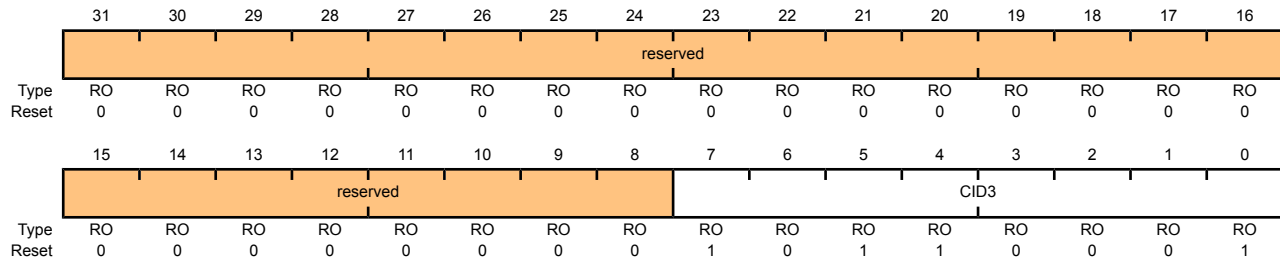
GPIO Port F base: 0x4002.5000

GPIO Port G base: 0x4002.6000

GPIO Port H base: 0x4002.7000

Offset 0xFFC

Type RO, reset 0x0000.00B1



Bit/Field	Name	Type	Reset	Description
31:8	reserved	RO	0x00	Software should not rely on the value of a reserved bit. To provide compatibility with future products, the value of a reserved bit should be preserved across a read-modify-write operation.
7:0	CID3	RO	0xB1	GPIO PrimeCell ID Register[31:24] Provides software a standard cross-peripheral identification system.

## 10 General-Purpose Timers

Programmable timers can be used to count or time external events that drive the Timer input pins. The Stellaris<sup>®</sup> General-Purpose Timer Module (GPTM) contains four GPTM blocks (Timer0, Timer1, Timer 2, and Timer 3). Each GPTM block provides two 16-bit timer/counters (referred to as TimerA and TimerB) that can be configured to operate independently as timers or event counters, or configured to operate as one 32-bit timer or one 32-bit Real-Time Clock (RTC). Timers can also be used to trigger analog-to-digital (ADC) conversions. The trigger signals from all of the general-purpose timers are ORed together before reaching the ADC module, so only one timer should be used to trigger ADC events.

**Note:** Timer2 is an internal timer and can only be used to generate internal interrupts or trigger ADC events.

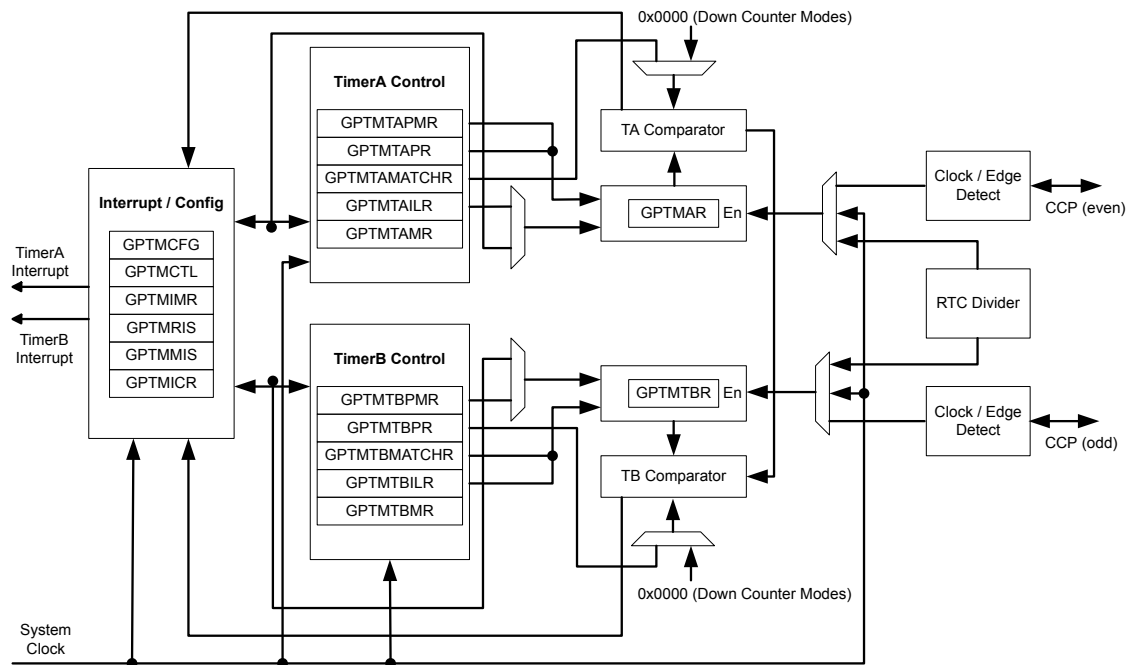
The General-Purpose Timer Module is one timing resource available on the Stellaris<sup>®</sup> microcontrollers. Other timer resources include the System Timer (SysTick) (see “System Timer (SysTick)” on page 36).

The following modes are supported:

- 32-bit Timer modes
  - Programmable one-shot timer
  - Programmable periodic timer
  - Real-Time Clock using 32.768-KHz input clock
  - Software-controlled event stalling (excluding RTC mode)
- 16-bit Timer modes
  - General-purpose timer function with an 8-bit prescaler (for one-shot and periodic modes only)
  - Programmable one-shot timer
  - Programmable periodic timer
  - Software-controlled event stalling
- 16-bit Input Capture modes
  - Input edge count capture
  - Input edge time capture
- 16-bit PWM mode
  - Simple PWM mode with software-programmable output inversion of the PWM signal

## 10.1 Block Diagram

Figure 10-1. GPTM Module Block Diagram



## 10.2 Functional Description

The main components of each GPTM block are two free-running 16-bit up/down counters (referred to as TimerA and TimerB), two 16-bit match registers, two prescaler match registers, and two 16-bit load/initialization registers and their associated control functions. The exact functionality of each GPTM is controlled by software and configured through the register interface.

Software configures the GPTM using the **GPTM Configuration (GPTMCFG)** register (see page 210), the **GPTM TimerA Mode (GPTMTAMR)** register (see page 211), and the **GPTM TimerB Mode (GPTMTBMR)** register (see page 213). When in one of the 32-bit modes, the timer can only act as a 32-bit timer. However, when configured in 16-bit mode, the GPTM can have its two 16-bit timers configured in any combination of the 16-bit modes.

### 10.2.1 GPTM Reset Conditions

After reset has been applied to the GPTM module, the module is in an inactive state, and all control registers are cleared and in their default states. Counters TimerA and TimerB are initialized to **0xFFFF**, along with their corresponding load registers: the **GPTM TimerA Interval Load (GPTMTAILR)** register (see page 224) and the **GPTM TimerB Interval Load (GPTMTBILR)** register (see page 225). The prescale counters are initialized to **0x00**: the **GPTM TimerA Prescale (GPTMTAPR)** register (see page 228) and the **GPTM TimerB Prescale (GPTMTBPR)** register (see page 229).

### 10.2.2 32-Bit Timer Operating Modes

**Note:** Both the odd- and even-numbered CCP pins are used for 16-bit mode. Only the even-numbered CCP pins are used for 32-bit mode.

This section describes the three GPTM 32-bit timer modes (One-Shot, Periodic, and RTC) and their configuration.

The GPTM is placed into 32-bit mode by writing a 0 (One-Shot/Periodic 32-bit timer mode) or a 1 (RTC mode) to the **GPTM Configuration (GPTMCFG)** register. In both configurations, certain GPTM registers are concatenated to form pseudo 32-bit registers. These registers include:

- **GPTM TimerA Interval Load (GPTMTAILR)** register [15:0], see page 224
- **GPTM TimerB Interval Load (GPTMTBILR)** register [15:0], see page 225
- **GPTM TimerA (GPTMTAR)** register [15:0], see page 232
- **GPTM TimerB (GPTMTBR)** register [15:0], see page 233

In the 32-bit modes, the GPTM translates a 32-bit write access to **GPTMTAILR** into a write access to both **GPTMTAILR** and **GPTMTBILR**. The resulting word ordering for such a write operation is:

```
GPTMTBILR[15:0]:GPTMTAILR[15:0]
```

Likewise, a read access to **GPTMTAR** returns the value:

```
GPTMTBR[15:0]:GPTMTAR[15:0]
```

### 10.2.2.1 32-Bit One-Shot/Periodic Timer Mode

In 32-bit one-shot and periodic timer modes, the concatenated versions of the TimerA and TimerB registers are configured as a 32-bit down-counter. The selection of one-shot or periodic mode is determined by the value written to the **TAMR** field of the **GPTM TimerA Mode (GPTMTAMR)** register (see page 211), and there is no need to write to the **GPTM TimerB Mode (GPTMTBMR)** register.

When software writes the **TAEN** bit in the **GPTM Control (GPTMCTL)** register (see page 215), the timer begins counting down from its preloaded value. Once the 0x0000.0000 state is reached, the timer reloads its start value from the concatenated **GPTMTAILR** on the next cycle. If configured to be a one-shot timer, the timer stops counting and clears the **TAEN** bit in the **GPTMCTL** register. If configured as a periodic timer, it continues counting.

In addition to reloading the count value, the GPTM generates interrupts and output triggers when it reaches the 0x00000000 state. The GPTM sets the **TATORIS** bit in the **GPTM Raw Interrupt Status (GPTMRIS)** register (see page 220), and holds it until it is cleared by writing the **GPTM Interrupt Clear (GPTMICR)** register (see page 222). If the time-out interrupt is enabled in the **GPTM Interrupt Mask (GPTIMR)** register (see page 218), the GPTM also sets the **TATOMIS** bit in the **GPTM Masked Interrupt Status (GPTMMIS)** register (see page 221).

The output trigger is a one-clock-cycle pulse that is asserted when the counter hits the 0x0000.0000 state, and deasserted on the following clock cycle. It is enabled by setting the **TAOTE** bit in **GPTMCTL**, and can trigger SoC-level events such as ADC conversions.

If software reloads the **GPTMTAILR** register while the counter is running, the counter loads the new value on the next clock cycle and continues counting from the new value.

If the **TASTALL** bit in the **GPTMCTL** register is asserted, the timer freezes counting until the signal is deasserted.

### 10.2.2.2 32-Bit Real-Time Clock Timer Mode

In Real-Time Clock (RTC) mode, the concatenated versions of the TimerA and TimerB registers are configured as a 32-bit up-counter. When RTC mode is selected for the first time, the counter is



loaded with a value of 0x0000.0001. All subsequent load values must be written to the **GPTM TimerA Match (GPTMTAMATCHR)** register (see page 226) by the controller.

The input clock on the CCP0, CCP2, or CCP4 pins is required to be 32.768 KHz in RTC mode. The clock signal is then divided down to a 1 Hz rate and is passed along to the input of the 32-bit counter.

When software writes the TAEN bit in the **GPTMCTL** register, the counter starts counting up from its preloaded value of 0x0000.0001. When the current count value matches the preloaded value in the **GPTMTAMATCHR** register, it rolls over to a value of 0x0000.0000 and continues counting until either a hardware reset, or it is disabled by software (clearing the TAEN bit). When a match occurs, the GPTM asserts the RTCRIS bit in **GPTMRIS**. If the RTC interrupt is enabled in **GPTIMR**, the GPTM also sets the RTCMIS bit in **GPTMISR** and generates a controller interrupt. The status flags are cleared by writing the RTCCINT bit in **GPTMICR**.

If the TASTALL and/or TBSTALL bits in the **GPTMCTL** register are set, the timer does not freeze if the RTCEN bit is set in **GPTMCTL**.

### 10.2.3 16-Bit Timer Operating Modes

The GPTM is placed into global 16-bit mode by writing a value of 0x4 to the **GPTM Configuration (GPTMCFG)** register (see page 210). This section describes each of the GPTM 16-bit modes of operation. TimerA and TimerB have identical modes, so a single description is given using an *n* to reference both.

#### 10.2.3.1 16-Bit One-Shot/Periodic Timer Mode

In 16-bit one-shot and periodic timer modes, the timer is configured as a 16-bit down-counter with an optional 8-bit prescaler that effectively extends the counting range of the timer to 24 bits. The selection of one-shot or periodic mode is determined by the value written to the TnMR field of the **GPTMTnMR** register. The optional prescaler is loaded into the **GPTM Timern Prescale (GPTMTnPR)** register.

When software writes the TnEN bit in the **GPTMCTL** register, the timer begins counting down from its preloaded value. Once the 0x0000 state is reached, the timer reloads its start value from **GPTMTnILR** and **GPTMTnPR** on the next cycle. If configured to be a one-shot timer, the timer stops counting and clears the TnEN bit in the **GPTMCTL** register. If configured as a periodic timer, it continues counting.

In addition to reloading the count value, the timer generates interrupts and output triggers when it reaches the 0x0000 state. The GPTM sets the TnTORIS bit in the **GPTMRIS** register, and holds it until it is cleared by writing the **GPTMICR** register. If the time-out interrupt is enabled in **GPTIMR**, the GPTM also sets the TnTOMIS bit in **GPTMISR** and generates a controller interrupt.

The output trigger is a one-clock-cycle pulse that is asserted when the counter hits the 0x0000 state, and deasserted on the following clock cycle. It is enabled by setting the TnOTE bit in the **GPTMCTL** register, and can trigger SoC-level events such as ADC conversions.

If software reloads the **GPTMTAILR** register while the counter is running, the counter loads the new value on the next clock cycle and continues counting from the new value.

If the TnSTALL bit in the **GPTMCTL** register is enabled, the timer freezes counting until the signal is deasserted.

The following example shows a variety of configurations for a 16-bit free running timer while using the prescaler. All values assume a 50-MHz clock with Tc=20 ns (clock period).

**Table 10-1. 16-Bit Timer With Prescaler Configurations**

Prescale	#Clock (T <sub>c</sub> ) <sup>a</sup>	Max Time	Units
00000000	1	1.3107	mS
00000001	2	2.6214	mS
00000010	3	3.9321	mS
-----	--	--	--
11111100	254	332.9229	mS
11111110	255	334.2336	mS
11111111	256	335.5443	mS

a. T<sub>c</sub> is the clock period.

### 10.2.3.2 16-Bit Input Edge Count Mode

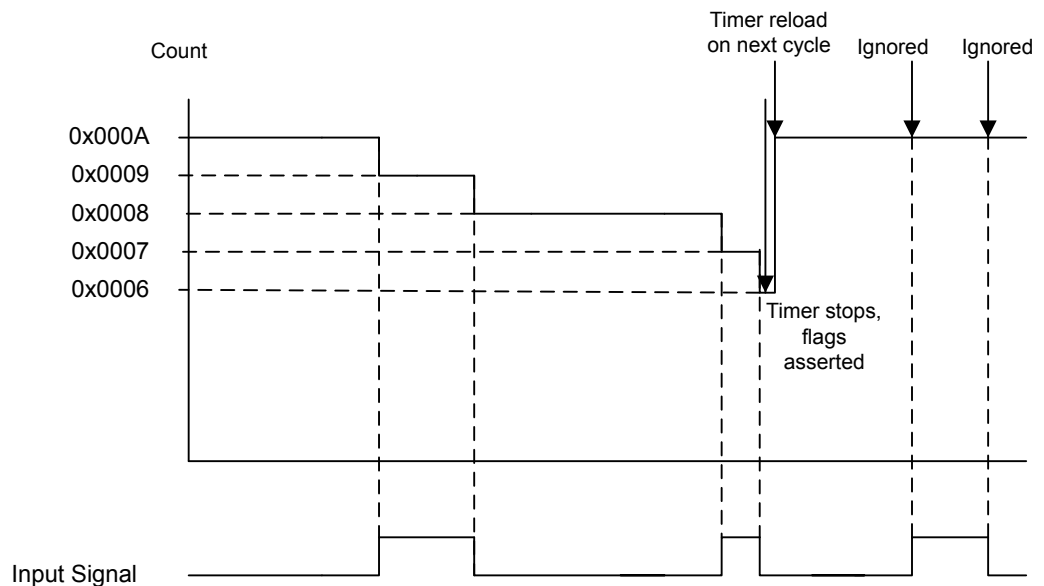
In Edge Count mode, the timer is configured as a down-counter capable of capturing three types of events: rising edge, falling edge, or both. To place the timer in Edge Count mode, the T<sub>n</sub>CMR bit of the **GPTMTnMR** register must be set to 0. The type of edge that the timer counts is determined by the T<sub>n</sub>EVENT fields of the **GPTMCTL** register. During initialization, the **GPTM Timern Match (GPTMTnMATCHR)** register is configured so that the difference between the value in the **GPTMTnILR** register and the **GPTMTnMATCHR** register equals the number of edge events that must be counted.

When software writes the T<sub>n</sub>EN bit in the **GPTM Control (GPTMCTL)** register, the timer is enabled for event capture. Each input event on the CCP pin decrements the counter by 1 until the event count matches **GPTMTnMATCHR**. When the counts match, the GPTM asserts the C<sub>n</sub>MRIS bit in the **GPTMRIS** register (and the C<sub>n</sub>MMIS bit, if the interrupt is not masked). The counter is then reloaded using the value in **GPTMTnILR**, and stopped since the GPTM automatically clears the T<sub>n</sub>EN bit in the **GPTMCTL** register. Once the event count has been reached, all further events are ignored until T<sub>n</sub>EN is re-enabled by software.

Figure 10-2 on page 203 shows how input edge count mode works. In this case, the timer start value is set to **GPTMTnILR** = 0x000A and the match value is set to **GPTMTnMATCHR** = 0x0006 so that four edge events are counted. The counter is configured to detect both edges of the input signal.

Note that the last two edges are not counted since the timer automatically clears the T<sub>n</sub>EN bit after the current count matches the value in the **GPTMTnMR** register.

Figure 10-2. 16-Bit Input Edge Count Mode Example



### 10.2.3.3 16-Bit Input Edge Time Mode

**Note:** The prescaler is not available in 16-Bit Input Edge Time mode.

In Edge Time mode, the timer is configured as a free-running down-counter initialized to the value loaded in the **GPTMTnILR** register (or 0xFFFF at reset). This mode allows for event capture of both rising and falling edges. The timer is placed into Edge Time mode by setting the **TnCMR** bit in the **GPTMTnMR** register, and the type of event that the timer captures is determined by the **TnEVENT** fields of the **GPTMCnTL** register.

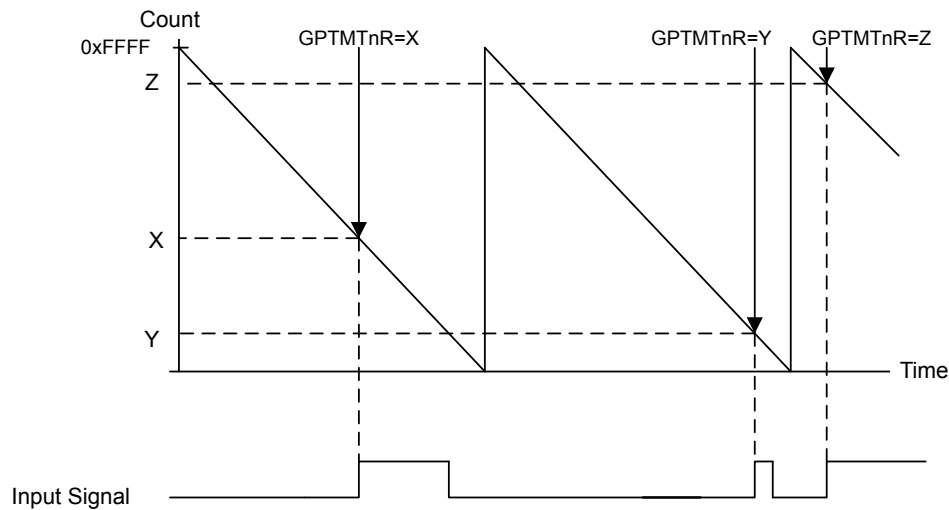
When software writes the **TnEN** bit in the **GPTMCTL** register, the timer is enabled for event capture. When the selected input event is detected, the current **Tn** counter value is captured in the **GPTMTnR** register and is available to be read by the controller. The GPTM then asserts the **CnERIS** bit (and the **CnEMIS** bit, if the interrupt is not masked).

After an event has been captured, the timer does not stop counting. It continues to count until the **TnEN** bit is cleared. When the timer reaches the 0x0000 state, it is reloaded with the value from the **GPTMnILR** register.

Figure 10-3 on page 204 shows how input edge timing mode works. In the diagram, it is assumed that the start value of the timer is the default value of 0xFFFF, and the timer is configured to capture rising edge events.

Each time a rising edge event is detected, the current count value is loaded into the **GPTMTnR** register, and is held there until another rising edge is detected (at which point the new count value is loaded into **GPTMTnR**).

Figure 10-3. 16-Bit Input Edge Time Mode Example



#### 10.2.3.4 16-Bit PWM Mode

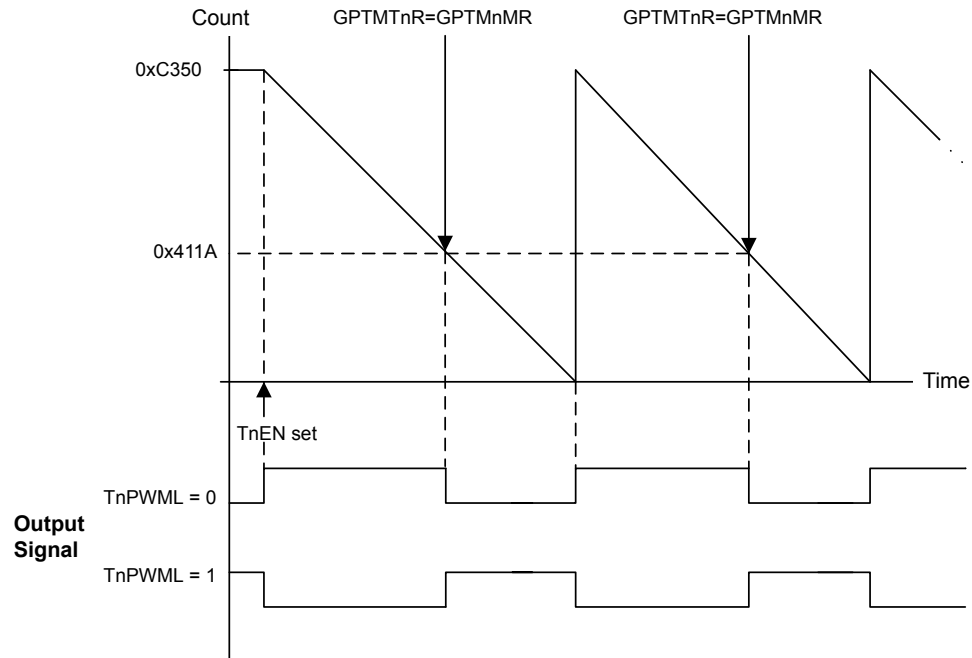
The GPTM supports a simple PWM generation mode. In PWM mode, the timer is configured as a down-counter with a start value (and thus period) defined by **GPTMTnILR**. PWM mode is enabled with the **GPTMTnMR** register by setting the  $T_nAMS$  bit to 0x1, the  $T_nCMR$  bit to 0x0, and the  $T_nMR$  field to 0x2.

When software writes the  $T_nEN$  bit in the **GPTMCTL** register, the counter begins counting down until it reaches the 0x0000 state. On the next counter cycle, the counter reloads its start value from **GPTMTnILR** (and **GPTMTnPR** if using a prescaler) and continues counting until disabled by software clearing the  $T_nEN$  bit in the **GPTMCTL** register. No interrupts or status bits are asserted in PWM mode.

The output PWM signal asserts when the counter is at the value of the **GPTMTnILR** register (its start state), and is deasserted when the counter value equals the value in the **GPTM Timern Match Register (GPTMnMATCHR)**. Software has the capability of inverting the output PWM signal by setting the  $T_nPWML$  bit in the **GPTMCTL** register.

Figure 10-4 on page 205 shows how to generate an output PWM with a 1-ms period and a 66% duty cycle assuming a 50-MHz input clock and  $T_nPWML = 0$  (duty cycle would be 33% for the  $T_nPWML = 1$  configuration). For this example, the start value is **GPTMnILR=0xC350** and the match value is **GPTMnMR=0x411A**.

Figure 10-4. 16-Bit PWM Mode Example



## 10.3 Initialization and Configuration

To use the general-purpose timers, the peripheral clock must be enabled by setting the `TIMER0`, `TIMER1`, `TIMER2`, and `TIMER3` bits in the `RCGC1` register.

This section shows module initialization and configuration examples for each of the supported timer modes.

### 10.3.1 32-Bit One-Shot/Periodic Timer Mode

The GPTM is configured for 32-bit One-Shot and Periodic modes by the following sequence:

1. Ensure the timer is disabled (the `TAEN` bit in the `GPTMCTL` register is cleared) before making any changes.
2. Write the **GPTM Configuration Register (GPTMCFG)** with a value of 0x0.
3. Set the `TAMR` field in the **GPTM TimerA Mode Register (GPTMTAMR)**:
  - a. Write a value of 0x1 for One-Shot mode.
  - b. Write a value of 0x2 for Periodic mode.
4. Load the start value into the **GPTM TimerA Interval Load Register (GPTMTAILR)**.
5. If interrupts are required, set the `TATOIM` bit in the **GPTM Interrupt Mask Register (GPTMIMR)**.
6. Set the `TAEN` bit in the `GPTMCTL` register to enable the timer and start counting.

7. Poll the `TATORIS` bit in the **GPTMRIS** register or wait for the interrupt to be generated (if enabled). In both cases, the status flags are cleared by writing a 1 to the `TATOCINT` bit of the **GPTM Interrupt Clear Register (GPTMICR)**.

In One-Shot mode, the timer stops counting after step 7 on page 206. To re-enable the timer, repeat the sequence. A timer configured in Periodic mode does not stop counting after it times out.

### 10.3.2 32-Bit Real-Time Clock (RTC) Mode

To use the RTC mode, the timer must have a 32.768-KHz input signal on its `CCP0`, `CCP2`, or `CCP4` pins. To enable the RTC feature, follow these steps:

1. Ensure the timer is disabled (the `TAEN` bit is cleared) before making any changes.
2. Write the **GPTM Configuration Register (GPTMCFG)** with a value of 0x1.
3. Write the desired match value to the **GPTM TimerA Match Register (GPTMTAMATCHR)**.
4. Set/clear the `RTCEN` bit in the **GPTM Control Register (GPTMCTL)** as desired.
5. If interrupts are required, set the `RTCIM` bit in the **GPTM Interrupt Mask Register (GPTMIMR)**.
6. Set the `TAEN` bit in the **GPTMCTL** register to enable the timer and start counting.

When the timer count equals the value in the **GPTMTAMATCHR** register, the counter is re-loaded with 0x0000.0000 and begins counting. If an interrupt is enabled, it does not have to be cleared.

### 10.3.3 16-Bit One-Shot/Periodic Timer Mode

A timer is configured for 16-bit One-Shot and Periodic modes by the following sequence:

1. Ensure the timer is disabled (the `TnEN` bit is cleared) before making any changes.
2. Write the **GPTM Configuration Register (GPTMCFG)** with a value of 0x4.
3. Set the `TnMR` field in the **GPTM Timer Mode (GPTMTnMR)** register:
  - a. Write a value of 0x1 for One-Shot mode.
  - b. Write a value of 0x2 for Periodic mode.
4. If a prescaler is to be used, write the prescale value to the **GPTM Timern Prescale Register (GPTMTnPR)**.
5. Load the start value into the **GPTM Timer Interval Load Register (GPTMTnILR)**.
6. If interrupts are required, set the `TnTOIM` bit in the **GPTM Interrupt Mask Register (GPTMIMR)**.
7. Set the `TnEN` bit in the **GPTM Control Register (GPTMCTL)** to enable the timer and start counting.
8. Poll the `TnTORIS` bit in the **GPTMRIS** register or wait for the interrupt to be generated (if enabled). In both cases, the status flags are cleared by writing a 1 to the `TnTOCINT` bit of the **GPTM Interrupt Clear Register (GPTMICR)**.

In One-Shot mode, the timer stops counting after step 8 on page 206. To re-enable the timer, repeat the sequence. A timer configured in Periodic mode does not stop counting after it times out.

### 10.3.4 16-Bit Input Edge Count Mode

A timer is configured to Input Edge Count mode by the following sequence:

1. Ensure the timer is disabled (the  $TnEN$  bit is cleared) before making any changes.
2. Write the **GPTM Configuration (GPTMCFG)** register with a value of 0x4.
3. In the **GPTM Timer Mode (GPTMTnMR)** register, write the  $TnCMR$  field to 0x0 and the  $TnMR$  field to 0x3.
4. Configure the type of event(s) that the timer captures by writing the  $TnEVENT$  field of the **GPTM Control (GPTMCTL)** register.
5. Load the timer start value into the **GPTM Timern Interval Load (GPTMTnILR)** register.
6. Load the desired event count into the **GPTM Timern Match (GPTMTnMATCHR)** register.
7. If interrupts are required, set the  $CnMIM$  bit in the **GPTM Interrupt Mask (GPTMIMR)** register.
8. Set the  $TnEN$  bit in the **GPTMCTL** register to enable the timer and begin waiting for edge events.
9. Poll the  $CnMRIS$  bit in the **GPTMRIS** register or wait for the interrupt to be generated (if enabled). In both cases, the status flags are cleared by writing a 1 to the  $CnMCINT$  bit of the **GPTM Interrupt Clear (GPTMICR)** register.

In Input Edge Count Mode, the timer stops after the desired number of edge events has been detected. To re-enable the timer, ensure that the  $TnEN$  bit is cleared and repeat step 4 on page 207-step 9 on page 207.

### 10.3.5 16-Bit Input Edge Timing Mode

A timer is configured to Input Edge Timing mode by the following sequence:

1. Ensure the timer is disabled (the  $TnEN$  bit is cleared) before making any changes.
2. Write the **GPTM Configuration (GPTMCFG)** register with a value of 0x4.
3. In the **GPTM Timer Mode (GPTMTnMR)** register, write the  $TnCMR$  field to 0x1 and the  $TnMR$  field to 0x3.
4. Configure the type of event that the timer captures by writing the  $TnEVENT$  field of the **GPTM Control (GPTMCTL)** register.
5. Load the timer start value into the **GPTM Timern Interval Load (GPTMTnILR)** register.
6. If interrupts are required, set the  $CnEIM$  bit in the **GPTM Interrupt Mask (GPTMIMR)** register.
7. Set the  $TnEN$  bit in the **GPTM Control (GPTMCTL)** register to enable the timer and start counting.
8. Poll the  $CnERIS$  bit in the **GPTMRIS** register or wait for the interrupt to be generated (if enabled). In both cases, the status flags are cleared by writing a 1 to the  $CnECINT$  bit of the **GPTM**

**Interrupt Clear (GPTMICR)** register. The time at which the event happened can be obtained by reading the **GPTM Timern (GPTMTnR)** register.

In Input Edge Timing mode, the timer continues running after an edge event has been detected, but the timer interval can be changed at any time by writing the **GPTMTnILR** register. The change takes effect at the next cycle after the write.

### 10.3.6 16-Bit PWM Mode

A timer is configured to PWM mode using the following sequence:

1. Ensure the timer is disabled (the  $T_{nEN}$  bit is cleared) before making any changes.
2. Write the **GPTM Configuration (GPTMCFG)** register with a value of 0x4.
3. In the **GPTM Timer Mode (GPTMTnMR)** register, set the  $T_{nAMS}$  bit to 0x1, the  $T_{nCMR}$  bit to 0x0, and the  $T_{nMR}$  field to 0x2.
4. Configure the output state of the PWM signal (whether or not it is inverted) in the  $T_{nEVENT}$  field of the **GPTM Control (GPTMCTL)** register.
5. Load the timer start value into the **GPTM Timern Interval Load (GPTMTnILR)** register.
6. Load the **GPTM Timern Match (GPTMTnMATCHR)** register with the desired value.
7. If a prescaler is going to be used, configure the **GPTM Timern Prescale (GPTMTnPR)** register and the **GPTM Timern Prescale Match (GPTMTnPMR)** register.
8. Set the  $T_{nEN}$  bit in the **GPTM Control (GPTMCTL)** register to enable the timer and begin generation of the output PWM signal.

In PWM Timing mode, the timer continues running after the PWM signal has been generated. The PWM period can be adjusted at any time by writing the **GPTMTnILR** register, and the change takes effect at the next cycle after the write.

## 10.4 Register Map

Table 10-2 on page 208 lists the GPTM registers. The offset listed is a hexadecimal increment to the register's address, relative to that timer's base address:

- Timer0: 0x4003.0000
- Timer1: 0x4003.1000
- Timer2: 0x4003.2000
- Timer3: 0x4003.3000

**Table 10-2. Timers Register Map**

Offset	Name	Type	Reset	Description	See page
0x000	GPTMCFG	R/W	0x0000.0000	GPTM Configuration	210
0x004	GPTMTAMR	R/W	0x0000.0000	GPTM TimerA Mode	211



Offset	Name	Type	Reset	Description	See page
0x008	GPTMTBMR	R/W	0x0000.0000	GPTM TimerB Mode	213
0x00C	GPTMCTL	R/W	0x0000.0000	GPTM Control	215
0x018	GPTMIMR	R/W	0x0000.0000	GPTM Interrupt Mask	218
0x01C	GPTMRIS	RO	0x0000.0000	GPTM Raw Interrupt Status	220
0x020	GPTMMIS	RO	0x0000.0000	GPTM Masked Interrupt Status	221
0x024	GPTMICR	W1C	0x0000.0000	GPTM Interrupt Clear	222
0x028	GPTMTAILR	R/W	0x0000.FFFF (16-bit mode) 0xFFFF.FFFF (32-bit mode)	GPTM TimerA Interval Load	224
0x02C	GPTMTBILR	R/W	0x0000.FFFF	GPTM TimerB Interval Load	225
0x030	GPTMTAMATCHR	R/W	0x0000.FFFF (16-bit mode) 0xFFFF.FFFF (32-bit mode)	GPTM TimerA Match	226
0x034	GPTMTBMATCHR	R/W	0x0000.FFFF	GPTM TimerB Match	227
0x038	GPTMTAPR	R/W	0x0000.0000	GPTM TimerA Prescale	228
0x03C	GPTMTBPR	R/W	0x0000.0000	GPTM TimerB Prescale	229
0x040	GPTMTAPMR	R/W	0x0000.0000	GPTM TimerA Prescale Match	230
0x044	GPTMTBPMR	R/W	0x0000.0000	GPTM TimerB Prescale Match	231
0x048	GPTMTAR	RO	0x0000.FFFF (16-bit mode) 0xFFFF.FFFF (32-bit mode)	GPTM TimerA	232
0x04C	GPTMTBR	RO	0x0000.FFFF	GPTM TimerB	233

## 10.5 Register Descriptions

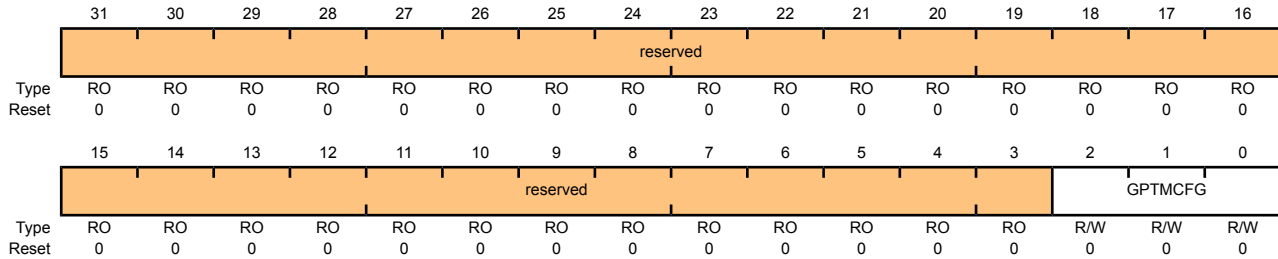
The remainder of this section lists and describes the GPTM registers, in numerical order by address offset.

### Register 1: GPTM Configuration (GPTMCFG), offset 0x000

This register configures the global operation of the GPTM module. The value written to this register determines whether the GPTM is in 32- or 16-bit mode.

#### GPTM Configuration (GPTMCFG)

Timer0 base: 0x4003.0000  
 Timer1 base: 0x4003.1000  
 Timer2 base: 0x4003.2000  
 Timer3 base: 0x4003.3000  
 Offset 0x000  
 Type R/W, reset 0x0000.0000



Bit/Field	Name	Type	Reset	Description
31:3	reserved	RO	0x00	Software should not rely on the value of a reserved bit. To provide compatibility with future products, the value of a reserved bit should be preserved across a read-modify-write operation.
2:0	GPTMCFG	R/W	0x0	GPTM Configuration

The GPTMCFG values are defined as follows:

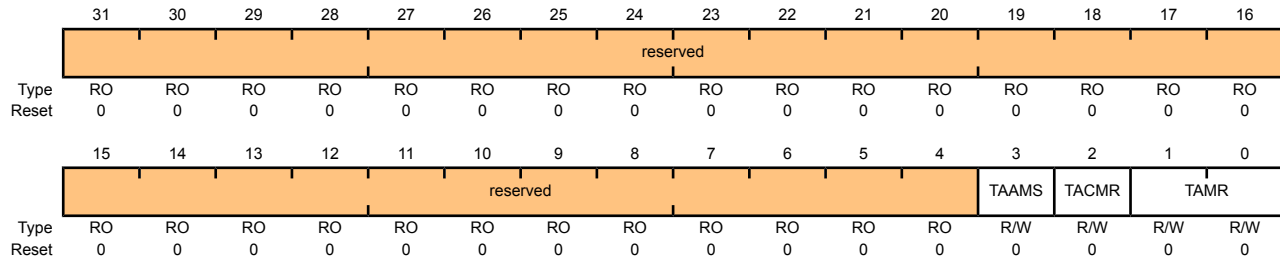
Value	Description
0x0	32-bit timer configuration.
0x1	32-bit real-time clock (RTC) counter configuration.
0x2	Reserved.
0x3	Reserved.
0x4-0x7	16-bit timer configuration, function is controlled by bits 1:0 of <b>GPTMTAMR</b> and <b>GPTMTBMR</b> .

## Register 2: GPTM TimerA Mode (GPTMTAMR), offset 0x004

This register configures the GPTM based on the configuration selected in the **GPTMCFG** register. When in 16-bit PWM mode, set the **TAAMS** bit to 0x1, the **TACMR** bit to 0x0, and the **TAMR** field to 0x2.

### GPTM TimerA Mode (GPTMTAMR)

Timer0 base: 0x4003.0000  
 Timer1 base: 0x4003.1000  
 Timer2 base: 0x4003.2000  
 Timer3 base: 0x4003.3000  
 Offset 0x004  
 Type R/W, reset 0x0000.0000



Bit/Field	Name	Type	Reset	Description						
31:4	reserved	RO	0x00	Software should not rely on the value of a reserved bit. To provide compatibility with future products, the value of a reserved bit should be preserved across a read-modify-write operation.						
3	TAAMS	R/W	0	GPTM TimerA Alternate Mode Select  The <b>TAAMS</b> values are defined as follows:  <table border="1"> <thead> <tr> <th>Value</th> <th>Description</th> </tr> </thead> <tbody> <tr> <td>0</td> <td>Capture mode is enabled.</td> </tr> <tr> <td>1</td> <td>PWM mode is enabled.</td> </tr> </tbody> </table> <p><b>Note:</b> To enable PWM mode, you must also clear the <b>TACMR</b> bit and set the <b>TAMR</b> field to 0x2.</p>	Value	Description	0	Capture mode is enabled.	1	PWM mode is enabled.
Value	Description									
0	Capture mode is enabled.									
1	PWM mode is enabled.									
2	TACMR	R/W	0	GPTM TimerA Capture Mode  The <b>TACMR</b> values are defined as follows:  <table border="1"> <thead> <tr> <th>Value</th> <th>Description</th> </tr> </thead> <tbody> <tr> <td>0</td> <td>Edge-Count mode.</td> </tr> <tr> <td>1</td> <td>Edge-Time mode.</td> </tr> </tbody> </table>	Value	Description	0	Edge-Count mode.	1	Edge-Time mode.
Value	Description									
0	Edge-Count mode.									
1	Edge-Time mode.									

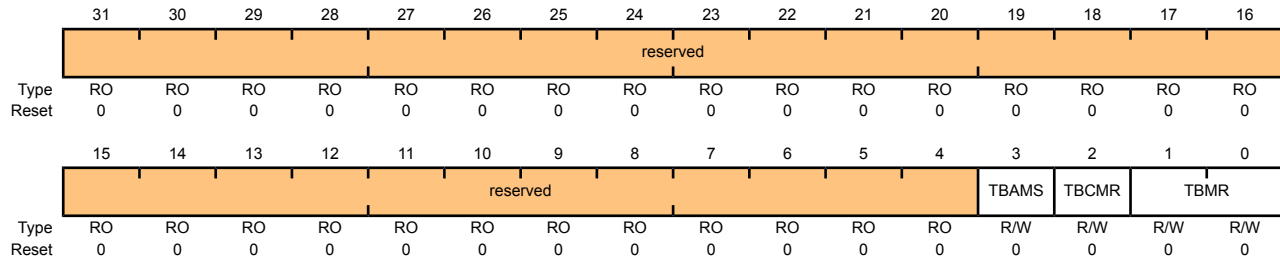
Bit/Field	Name	Type	Reset	Description										
1:0	TAMR	R/W	0x0	<p>GPTM TimerA Mode</p> <p>The TAMR values are defined as follows:</p> <table border="1"><thead><tr><th>Value</th><th>Description</th></tr></thead><tbody><tr><td>0x0</td><td>Reserved.</td></tr><tr><td>0x1</td><td>One-Shot Timer mode.</td></tr><tr><td>0x2</td><td>Periodic Timer mode.</td></tr><tr><td>0x3</td><td>Capture mode.</td></tr></tbody></table> <p>The Timer mode is based on the timer configuration defined by bits 2:0 in the <b>GPTMCFG</b> register (16-or 32-bit).</p> <p>In 16-bit timer configuration, TAMR controls the 16-bit timer modes for TimerA.</p> <p>In 32-bit timer configuration, this register controls the mode and the contents of <b>GPTMTBMR</b> are ignored.</p>	Value	Description	0x0	Reserved.	0x1	One-Shot Timer mode.	0x2	Periodic Timer mode.	0x3	Capture mode.
Value	Description													
0x0	Reserved.													
0x1	One-Shot Timer mode.													
0x2	Periodic Timer mode.													
0x3	Capture mode.													

### Register 3: GPTM TimerB Mode (GPTMTBMR), offset 0x008

This register configures the GPTM based on the configuration selected in the **GPTMCFG** register. When in 16-bit PWM mode, set the **TBAMS** bit to 0x1, the **TBCMR** bit to 0x0, and the **TBMR** field to 0x2.

#### GPTM TimerB Mode (GPTMTBMR)

Timer0 base: 0x4003.0000  
 Timer1 base: 0x4003.1000  
 Timer2 base: 0x4003.2000  
 Timer3 base: 0x4003.3000  
 Offset 0x008  
 Type R/W, reset 0x0000.0000



Bit/Field	Name	Type	Reset	Description						
31:4	reserved	RO	0x00	Software should not rely on the value of a reserved bit. To provide compatibility with future products, the value of a reserved bit should be preserved across a read-modify-write operation.						
3	TBAMS	R/W	0	GPTM TimerB Alternate Mode Select  The <b>TBAMS</b> values are defined as follows:  <table border="1"> <thead> <tr> <th>Value</th> <th>Description</th> </tr> </thead> <tbody> <tr> <td>0</td> <td>Capture mode is enabled.</td> </tr> <tr> <td>1</td> <td>PWM mode is enabled.</td> </tr> </tbody> </table> <p><b>Note:</b> To enable PWM mode, you must also clear the <b>TBCMR</b> bit and set the <b>TBMR</b> field to 0x2.</p>	Value	Description	0	Capture mode is enabled.	1	PWM mode is enabled.
Value	Description									
0	Capture mode is enabled.									
1	PWM mode is enabled.									
2	TBCMR	R/W	0	GPTM TimerB Capture Mode  The <b>TBCMR</b> values are defined as follows:  <table border="1"> <thead> <tr> <th>Value</th> <th>Description</th> </tr> </thead> <tbody> <tr> <td>0</td> <td>Edge-Count mode.</td> </tr> <tr> <td>1</td> <td>Edge-Time mode.</td> </tr> </tbody> </table>	Value	Description	0	Edge-Count mode.	1	Edge-Time mode.
Value	Description									
0	Edge-Count mode.									
1	Edge-Time mode.									

Bit/Field	Name	Type	Reset	Description										
1:0	TBMR	R/W	0x0	<p>GPTM TimerB Mode</p> <p>The TBMR values are defined as follows:</p> <table border="1"><thead><tr><th>Value</th><th>Description</th></tr></thead><tbody><tr><td>0x0</td><td>Reserved.</td></tr><tr><td>0x1</td><td>One-Shot Timer mode.</td></tr><tr><td>0x2</td><td>Periodic Timer mode.</td></tr><tr><td>0x3</td><td>Capture mode.</td></tr></tbody></table> <p>The timer mode is based on the timer configuration defined by bits 2:0 in the <b>GPTMCFG</b> register.</p> <p>In 16-bit timer configuration, these bits control the 16-bit timer modes for TimerB.</p> <p>In 32-bit timer configuration, this register's contents are ignored and <b>GPTMTAMR</b> is used.</p>	Value	Description	0x0	Reserved.	0x1	One-Shot Timer mode.	0x2	Periodic Timer mode.	0x3	Capture mode.
Value	Description													
0x0	Reserved.													
0x1	One-Shot Timer mode.													
0x2	Periodic Timer mode.													
0x3	Capture mode.													

### Register 4: GPTM Control (GPTMCTL), offset 0x00C

This register is used alongside the **GPTMCFG** and **GMTMTnMR** registers to fine-tune the timer configuration, and to enable other features such as timer stall and the output trigger. The output trigger can be used to initiate transfers on the ADC module.

#### GPTM Control (GPTMCTL)

Timer0 base: 0x4003.0000  
 Timer1 base: 0x4003.1000  
 Timer2 base: 0x4003.2000  
 Timer3 base: 0x4003.3000  
 Offset 0x00C  
 Type R/W, reset 0x0000.0000

	31	30	29	28	27	26	25	24	23	22	21	20	19	18	17	16
	reserved															
Type	RO	RO	RO	RO	RO	RO	RO	RO	RO	RO	RO	RO	RO	RO	RO	RO
Reset	0	0	0	0	0	0	0	0	0	0	0	0	0	0	0	0
	15	14	13	12	11	10	9	8	7	6	5	4	3	2	1	0
	reserved	TBPWML	TBOTE	reserved	TBEVENT	TBSTALL	TBEN	reserved	TAPWML	TAOTE	RTCEN	TAEVENT	TASTALL	TAEN		
Type	RO	R/W	R/W	RO	R/W	R/W	R/W	RO	R/W	R/W	R/W	R/W	R/W	R/W	R/W	R/W
Reset	0	0	0	0	0	0	0	0	0	0	0	0	0	0	0	0

Bit/Field	Name	Type	Reset	Description
31:15	reserved	RO	0x00	Software should not rely on the value of a reserved bit. To provide compatibility with future products, the value of a reserved bit should be preserved across a read-modify-write operation.
14	TBPWML	R/W	0	GPTM TimerB PWM Output Level  The TBPWML values are defined as follows:  Value Description 0 Output is unaffected. 1 Output is inverted.
13	TBOTE	R/W	0	GPTM TimerB Output Trigger Enable  The TBOTE values are defined as follows:  Value Description 0 The output TimerB trigger is disabled. 1 The output TimerB trigger is enabled.
12	reserved	RO	0	Software should not rely on the value of a reserved bit. To provide compatibility with future products, the value of a reserved bit should be preserved across a read-modify-write operation.

Bit/Field	Name	Type	Reset	Description										
11:10	TBEVENT	R/W	0x0	<p>GPTM TimerB Event Mode</p> <p>The TBEVENT values are defined as follows:</p> <table border="1"> <thead> <tr> <th>Value</th> <th>Description</th> </tr> </thead> <tbody> <tr> <td>0x0</td> <td>Positive edge.</td> </tr> <tr> <td>0x1</td> <td>Negative edge.</td> </tr> <tr> <td>0x2</td> <td>Reserved</td> </tr> <tr> <td>0x3</td> <td>Both edges.</td> </tr> </tbody> </table>	Value	Description	0x0	Positive edge.	0x1	Negative edge.	0x2	Reserved	0x3	Both edges.
Value	Description													
0x0	Positive edge.													
0x1	Negative edge.													
0x2	Reserved													
0x3	Both edges.													
9	TBSTALL	R/W	0	<p>GPTM TimerB Stall Enable</p> <p>The TBSTALL values are defined as follows:</p> <table border="1"> <thead> <tr> <th>Value</th> <th>Description</th> </tr> </thead> <tbody> <tr> <td>0</td> <td>TimerB stalling is disabled.</td> </tr> <tr> <td>1</td> <td>TimerB stalling is enabled.</td> </tr> </tbody> </table>	Value	Description	0	TimerB stalling is disabled.	1	TimerB stalling is enabled.				
Value	Description													
0	TimerB stalling is disabled.													
1	TimerB stalling is enabled.													
8	TBEN	R/W	0	<p>GPTM TimerB Enable</p> <p>The TBEN values are defined as follows:</p> <table border="1"> <thead> <tr> <th>Value</th> <th>Description</th> </tr> </thead> <tbody> <tr> <td>0</td> <td>TimerB is disabled.</td> </tr> <tr> <td>1</td> <td>TimerB is enabled and begins counting or the capture logic is enabled based on the <b>GPTMCFG</b> register.</td> </tr> </tbody> </table>	Value	Description	0	TimerB is disabled.	1	TimerB is enabled and begins counting or the capture logic is enabled based on the <b>GPTMCFG</b> register.				
Value	Description													
0	TimerB is disabled.													
1	TimerB is enabled and begins counting or the capture logic is enabled based on the <b>GPTMCFG</b> register.													
7	reserved	RO	0	Software should not rely on the value of a reserved bit. To provide compatibility with future products, the value of a reserved bit should be preserved across a read-modify-write operation.										
6	TAPWML	R/W	0	<p>GPTM TimerA PWM Output Level</p> <p>The TAPWML values are defined as follows:</p> <table border="1"> <thead> <tr> <th>Value</th> <th>Description</th> </tr> </thead> <tbody> <tr> <td>0</td> <td>Output is unaffected.</td> </tr> <tr> <td>1</td> <td>Output is inverted.</td> </tr> </tbody> </table>	Value	Description	0	Output is unaffected.	1	Output is inverted.				
Value	Description													
0	Output is unaffected.													
1	Output is inverted.													
5	TAOTE	R/W	0	<p>GPTM TimerA Output Trigger Enable</p> <p>The TAOTE values are defined as follows:</p> <table border="1"> <thead> <tr> <th>Value</th> <th>Description</th> </tr> </thead> <tbody> <tr> <td>0</td> <td>The output TimerA trigger is disabled.</td> </tr> <tr> <td>1</td> <td>The output TimerA trigger is enabled.</td> </tr> </tbody> </table>	Value	Description	0	The output TimerA trigger is disabled.	1	The output TimerA trigger is enabled.				
Value	Description													
0	The output TimerA trigger is disabled.													
1	The output TimerA trigger is enabled.													



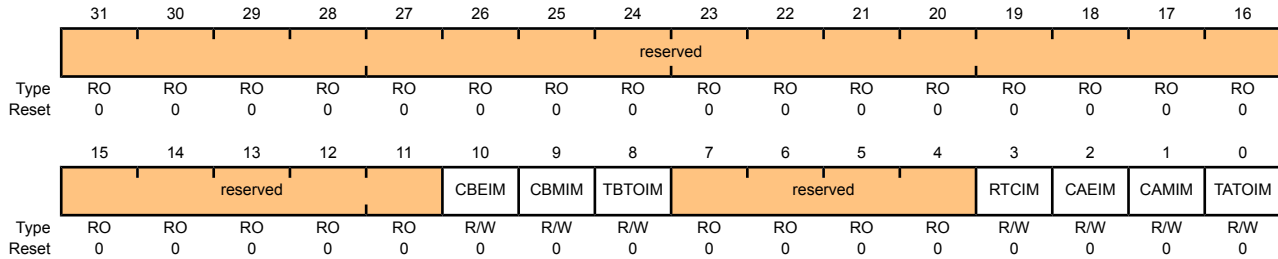
Bit/Field	Name	Type	Reset	Description										
4	RTCEN	R/W	0	<p>GPTM RTC Enable</p> <p>The <code>RTCEN</code> values are defined as follows:</p> <table border="1"> <thead> <tr> <th>Value</th> <th>Description</th> </tr> </thead> <tbody> <tr> <td>0</td> <td>RTC counting is disabled.</td> </tr> <tr> <td>1</td> <td>RTC counting is enabled.</td> </tr> </tbody> </table>	Value	Description	0	RTC counting is disabled.	1	RTC counting is enabled.				
Value	Description													
0	RTC counting is disabled.													
1	RTC counting is enabled.													
3:2	TAEVENT	R/W	0x0	<p>GPTM TimerA Event Mode</p> <p>The <code>TAEVENT</code> values are defined as follows:</p> <table border="1"> <thead> <tr> <th>Value</th> <th>Description</th> </tr> </thead> <tbody> <tr> <td>0x0</td> <td>Positive edge.</td> </tr> <tr> <td>0x1</td> <td>Negative edge.</td> </tr> <tr> <td>0x2</td> <td>Reserved</td> </tr> <tr> <td>0x3</td> <td>Both edges.</td> </tr> </tbody> </table>	Value	Description	0x0	Positive edge.	0x1	Negative edge.	0x2	Reserved	0x3	Both edges.
Value	Description													
0x0	Positive edge.													
0x1	Negative edge.													
0x2	Reserved													
0x3	Both edges.													
1	TASTALL	R/W	0	<p>GPTM TimerA Stall Enable</p> <p>The <code>TASTALL</code> values are defined as follows:</p> <table border="1"> <thead> <tr> <th>Value</th> <th>Description</th> </tr> </thead> <tbody> <tr> <td>0</td> <td>TimerA stalling is disabled.</td> </tr> <tr> <td>1</td> <td>TimerA stalling is enabled.</td> </tr> </tbody> </table>	Value	Description	0	TimerA stalling is disabled.	1	TimerA stalling is enabled.				
Value	Description													
0	TimerA stalling is disabled.													
1	TimerA stalling is enabled.													
0	TAEN	R/W	0	<p>GPTM TimerA Enable</p> <p>The <code>TAEN</code> values are defined as follows:</p> <table border="1"> <thead> <tr> <th>Value</th> <th>Description</th> </tr> </thead> <tbody> <tr> <td>0</td> <td>TimerA is disabled.</td> </tr> <tr> <td>1</td> <td>TimerA is enabled and begins counting or the capture logic is enabled based on the <code>GPTMCFG</code> register.</td> </tr> </tbody> </table>	Value	Description	0	TimerA is disabled.	1	TimerA is enabled and begins counting or the capture logic is enabled based on the <code>GPTMCFG</code> register.				
Value	Description													
0	TimerA is disabled.													
1	TimerA is enabled and begins counting or the capture logic is enabled based on the <code>GPTMCFG</code> register.													

## Register 5: GPTM Interrupt Mask (GPTMIMR), offset 0x018

This register allows software to enable/disable GPTM controller-level interrupts. Writing a 1 enables the interrupt, while writing a 0 disables it.

### GPTM Interrupt Mask (GPTMIMR)

Timer0 base: 0x4003.0000  
 Timer1 base: 0x4003.1000  
 Timer2 base: 0x4003.2000  
 Timer3 base: 0x4003.3000  
 Offset 0x018  
 Type R/W, reset 0x0000.0000



Bit/Field	Name	Type	Reset	Description
31:11	reserved	RO	0x00	Software should not rely on the value of a reserved bit. To provide compatibility with future products, the value of a reserved bit should be preserved across a read-modify-write operation.
10	CBEIM	R/W	0	GPTM CaptureB Event Interrupt Mask The CBEIM values are defined as follows: Value Description 0 Interrupt is disabled. 1 Interrupt is enabled.
9	CBMIM	R/W	0	GPTM CaptureB Match Interrupt Mask The CBMIM values are defined as follows: Value Description 0 Interrupt is disabled. 1 Interrupt is enabled.
8	TBTOIM	R/W	0	GPTM TimerB Time-Out Interrupt Mask The TBTOIM values are defined as follows: Value Description 0 Interrupt is disabled. 1 Interrupt is enabled.
7:4	reserved	RO	0	Software should not rely on the value of a reserved bit. To provide compatibility with future products, the value of a reserved bit should be preserved across a read-modify-write operation.

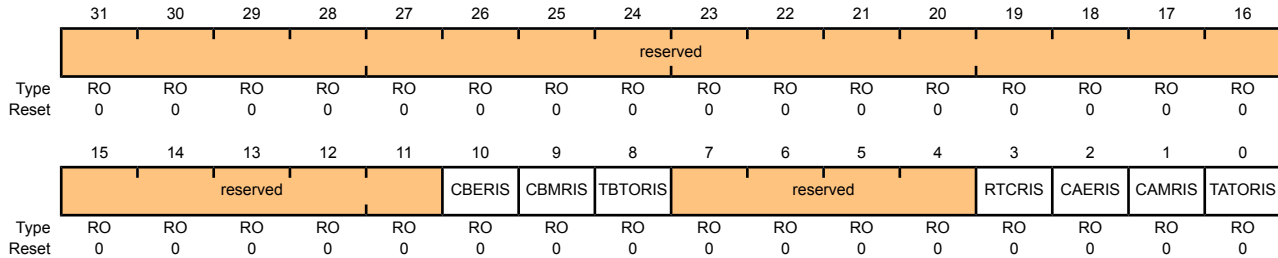
Bit/Field	Name	Type	Reset	Description						
3	RTCIM	R/W	0	<p>GPTM RTC Interrupt Mask</p> <p>The RTCIM values are defined as follows:</p> <table border="1"> <thead> <tr> <th>Value</th> <th>Description</th> </tr> </thead> <tbody> <tr> <td>0</td> <td>Interrupt is disabled.</td> </tr> <tr> <td>1</td> <td>Interrupt is enabled.</td> </tr> </tbody> </table>	Value	Description	0	Interrupt is disabled.	1	Interrupt is enabled.
Value	Description									
0	Interrupt is disabled.									
1	Interrupt is enabled.									
2	CAEIM	R/W	0	<p>GPTM CaptureA Event Interrupt Mask</p> <p>The CAEIM values are defined as follows:</p> <table border="1"> <thead> <tr> <th>Value</th> <th>Description</th> </tr> </thead> <tbody> <tr> <td>0</td> <td>Interrupt is disabled.</td> </tr> <tr> <td>1</td> <td>Interrupt is enabled.</td> </tr> </tbody> </table>	Value	Description	0	Interrupt is disabled.	1	Interrupt is enabled.
Value	Description									
0	Interrupt is disabled.									
1	Interrupt is enabled.									
1	CAMIM	R/W	0	<p>GPTM CaptureA Match Interrupt Mask</p> <p>The CAMIM values are defined as follows:</p> <table border="1"> <thead> <tr> <th>Value</th> <th>Description</th> </tr> </thead> <tbody> <tr> <td>0</td> <td>Interrupt is disabled.</td> </tr> <tr> <td>1</td> <td>Interrupt is enabled.</td> </tr> </tbody> </table>	Value	Description	0	Interrupt is disabled.	1	Interrupt is enabled.
Value	Description									
0	Interrupt is disabled.									
1	Interrupt is enabled.									
0	TATOIM	R/W	0	<p>GPTM TimerA Time-Out Interrupt Mask</p> <p>The TATOIM values are defined as follows:</p> <table border="1"> <thead> <tr> <th>Value</th> <th>Description</th> </tr> </thead> <tbody> <tr> <td>0</td> <td>Interrupt is disabled.</td> </tr> <tr> <td>1</td> <td>Interrupt is enabled.</td> </tr> </tbody> </table>	Value	Description	0	Interrupt is disabled.	1	Interrupt is enabled.
Value	Description									
0	Interrupt is disabled.									
1	Interrupt is enabled.									

## Register 6: GPTM Raw Interrupt Status (GPTMRIS), offset 0x01C

This register shows the state of the GPTM's internal interrupt signal. These bits are set whether or not the interrupt is masked in the **GPTMIMR** register. Each bit can be cleared by writing a 1 to its corresponding bit in **GPTMICR**.

### GPTM Raw Interrupt Status (GPTMRIS)

Timer0 base: 0x4003.0000  
 Timer1 base: 0x4003.1000  
 Timer2 base: 0x4003.2000  
 Timer3 base: 0x4003.3000  
 Offset 0x01C  
 Type RO, reset 0x0000.0000



Bit/Field	Name	Type	Reset	Description
31:11	reserved	RO	0x00	Software should not rely on the value of a reserved bit. To provide compatibility with future products, the value of a reserved bit should be preserved across a read-modify-write operation.
10	CBERIS	RO	0	GPTM CaptureB Event Raw Interrupt This is the CaptureB Event interrupt status prior to masking.
9	CBMRIS	RO	0	GPTM CaptureB Match Raw Interrupt This is the CaptureB Match interrupt status prior to masking.
8	TBTORIS	RO	0	GPTM TimerB Time-Out Raw Interrupt This is the TimerB time-out interrupt status prior to masking.
7:4	reserved	RO	0x0	Software should not rely on the value of a reserved bit. To provide compatibility with future products, the value of a reserved bit should be preserved across a read-modify-write operation.
3	RTCRIS	RO	0	GPTM RTC Raw Interrupt This is the RTC Event interrupt status prior to masking.
2	CAERIS	RO	0	GPTM CaptureA Event Raw Interrupt This is the CaptureA Event interrupt status prior to masking.
1	CAMRIS	RO	0	GPTM CaptureA Match Raw Interrupt This is the CaptureA Match interrupt status prior to masking.
0	TATORIS	RO	0	GPTM TimerA Time-Out Raw Interrupt This the TimerA time-out interrupt status prior to masking.

## Register 7: GPTM Masked Interrupt Status (GPTMMIS), offset 0x020

This register show the state of the GPTM's controller-level interrupt. If an interrupt is unmasked in **GPTMIMR**, and there is an event that causes the interrupt to be asserted, the corresponding bit is set in this register. All bits are cleared by writing a 1 to the corresponding bit in **GPTMICR**.

### GPTM Masked Interrupt Status (GPTMMIS)

Timer0 base: 0x4003.0000  
 Timer1 base: 0x4003.1000  
 Timer2 base: 0x4003.2000  
 Timer3 base: 0x4003.3000  
 Offset 0x020  
 Type RO, reset 0x0000.0000

	31	30	29	28	27	26	25	24	23	22	21	20	19	18	17	16
	reserved															
Type	RO	RO	RO	RO	RO	RO	RO	RO	RO	RO	RO	RO	RO	RO	RO	RO
Reset	0	0	0	0	0	0	0	0	0	0	0	0	0	0	0	0
	15	14	13	12	11	10	9	8	7	6	5	4	3	2	1	0
	reserved					CBEMIS	CBMMIS	TBTOMIS	reserved				RTCMIS	CAEMIS	CAMMIS	TATOMIS
Type	RO	RO	RO	RO	RO	RO	RO	RO	RO	RO	RO	RO	RO	RO	RO	RO
Reset	0	0	0	0	0	0	0	0	0	0	0	0	0	0	0	0

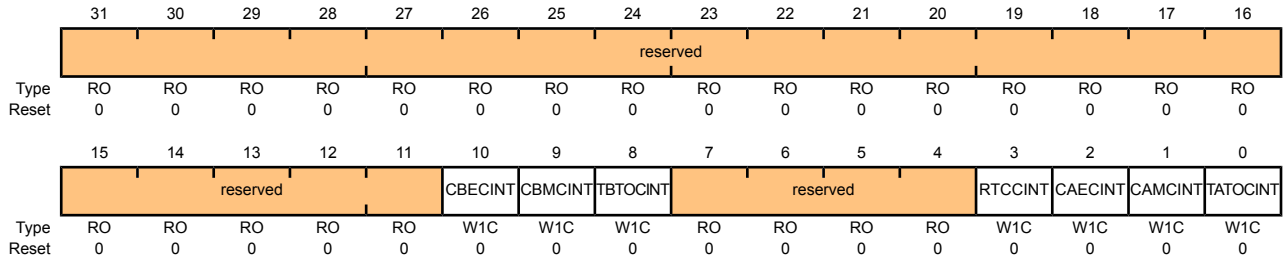
Bit/Field	Name	Type	Reset	Description
31:11	reserved	RO	0x00	Software should not rely on the value of a reserved bit. To provide compatibility with future products, the value of a reserved bit should be preserved across a read-modify-write operation.
10	CBEMIS	RO	0	GPTM CaptureB Event Masked Interrupt This is the CaptureB event interrupt status after masking.
9	CBMMIS	RO	0	GPTM CaptureB Match Masked Interrupt This is the CaptureB match interrupt status after masking.
8	TBTOMIS	RO	0	GPTM TimerB Time-Out Masked Interrupt This is the TimerB time-out interrupt status after masking.
7:4	reserved	RO	0x0	Software should not rely on the value of a reserved bit. To provide compatibility with future products, the value of a reserved bit should be preserved across a read-modify-write operation.
3	RTCMIS	RO	0	GPTM RTC Masked Interrupt This is the RTC event interrupt status after masking.
2	CAEMIS	RO	0	GPTM CaptureA Event Masked Interrupt This is the CaptureA event interrupt status after masking.
1	CAMMIS	RO	0	GPTM CaptureA Match Masked Interrupt This is the CaptureA match interrupt status after masking.
0	TATOMIS	RO	0	GPTM TimerA Time-Out Masked Interrupt This is the TimerA time-out interrupt status after masking.

### Register 8: GPTM Interrupt Clear (GPTMICR), offset 0x024

This register is used to clear the status bits in the **GPTMRIS** and **GPTMMIS** registers. Writing a 1 to a bit clears the corresponding bit in the **GPTMRIS** and **GPTMMIS** registers.

#### GPTM Interrupt Clear (GPTMICR)

Timer0 base: 0x4003.0000  
 Timer1 base: 0x4003.1000  
 Timer2 base: 0x4003.2000  
 Timer3 base: 0x4003.3000  
 Offset 0x024  
 Type W1C, reset 0x0000.0000



Bit/Field	Name	Type	Reset	Description
31:11	reserved	RO	0x00	Software should not rely on the value of a reserved bit. To provide compatibility with future products, the value of a reserved bit should be preserved across a read-modify-write operation.
10	CBECINT	W1C	0	GPTM CaptureB Event Interrupt Clear  The <b>CBECINT</b> values are defined as follows:  Value Description 0 The interrupt is unaffected. 1 The interrupt is cleared.
9	CBMCINT	W1C	0	GPTM CaptureB Match Interrupt Clear  The <b>CBMCINT</b> values are defined as follows:  Value Description 0 The interrupt is unaffected. 1 The interrupt is cleared.
8	TBTOCINT	W1C	0	GPTM TimerB Time-Out Interrupt Clear  The <b>TBTOCINT</b> values are defined as follows:  Value Description 0 The interrupt is unaffected. 1 The interrupt is cleared.
7:4	reserved	RO	0x0	Software should not rely on the value of a reserved bit. To provide compatibility with future products, the value of a reserved bit should be preserved across a read-modify-write operation.

Bit/Field	Name	Type	Reset	Description						
3	RTCCINT	W1C	0	<p>GPTM RTC Interrupt Clear</p> <p>The RTCCINT values are defined as follows:</p> <table border="1"> <thead> <tr> <th>Value</th> <th>Description</th> </tr> </thead> <tbody> <tr> <td>0</td> <td>The interrupt is unaffected.</td> </tr> <tr> <td>1</td> <td>The interrupt is cleared.</td> </tr> </tbody> </table>	Value	Description	0	The interrupt is unaffected.	1	The interrupt is cleared.
Value	Description									
0	The interrupt is unaffected.									
1	The interrupt is cleared.									
2	CAECINT	W1C	0	<p>GPTM CaptureA Event Interrupt Clear</p> <p>The CAECINT values are defined as follows:</p> <table border="1"> <thead> <tr> <th>Value</th> <th>Description</th> </tr> </thead> <tbody> <tr> <td>0</td> <td>The interrupt is unaffected.</td> </tr> <tr> <td>1</td> <td>The interrupt is cleared.</td> </tr> </tbody> </table>	Value	Description	0	The interrupt is unaffected.	1	The interrupt is cleared.
Value	Description									
0	The interrupt is unaffected.									
1	The interrupt is cleared.									
1	CAMCINT	W1C	0	<p>GPTM CaptureA Match Raw Interrupt</p> <p>This is the CaptureA match interrupt status after masking.</p>						
0	TATOCINT	W1C	0	<p>GPTM TimerA Time-Out Raw Interrupt</p> <p>The TATOCINT values are defined as follows:</p> <table border="1"> <thead> <tr> <th>Value</th> <th>Description</th> </tr> </thead> <tbody> <tr> <td>0</td> <td>The interrupt is unaffected.</td> </tr> <tr> <td>1</td> <td>The interrupt is cleared.</td> </tr> </tbody> </table>	Value	Description	0	The interrupt is unaffected.	1	The interrupt is cleared.
Value	Description									
0	The interrupt is unaffected.									
1	The interrupt is cleared.									

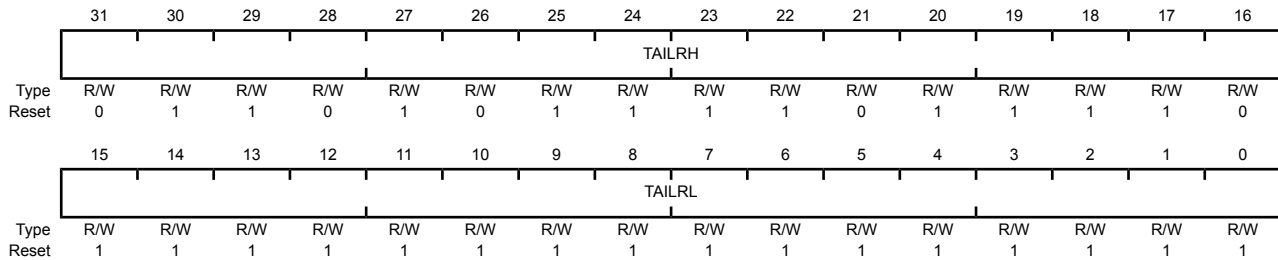
### Register 9: GPTM TimerA Interval Load (GPTMTAILR), offset 0x028

This register is used to load the starting count value into the timer. When GPTM is configured to one of the 32-bit modes, **GPTMTAILR** appears as a 32-bit register (the upper 16-bits correspond to the contents of the **GPTM TimerB Interval Load (GPTMTBILR)** register). In 16-bit mode, the upper 16 bits of this register read as 0s and have no effect on the state of **GPTMTBILR**.

#### GPTM TimerA Interval Load (GPTMTAILR)

Timer0 base: 0x4003.0000  
 Timer1 base: 0x4003.1000  
 Timer2 base: 0x4003.2000  
 Timer3 base: 0x4003.3000  
 Offset 0x028

Type R/W, reset 0x0000.FFFF (16-bit mode) and 0xFFFF.FFFF (32-bit mode)



Bit/Field	Name	Type	Reset	Description
31:16	TAILRH	R/W	0xFFFF (32-bit mode) 0x0000 (16-bit mode)	GPTM TimerA Interval Load Register High  When configured for 32-bit mode via the <b>GPTMCFG</b> register, the <b>GPTM TimerB Interval Load (GPTMTBILR)</b> register loads this value on a write. A read returns the current value of <b>GPTMTBILR</b> .  In 16-bit mode, this field reads as 0 and does not have an effect on the state of <b>GPTMTBILR</b> .
15:0	TAILRL	R/W	0xFFFF	GPTM TimerA Interval Load Register Low  For both 16- and 32-bit modes, writing this field loads the counter for TimerA. A read returns the current value of <b>GPTMTAILR</b> .

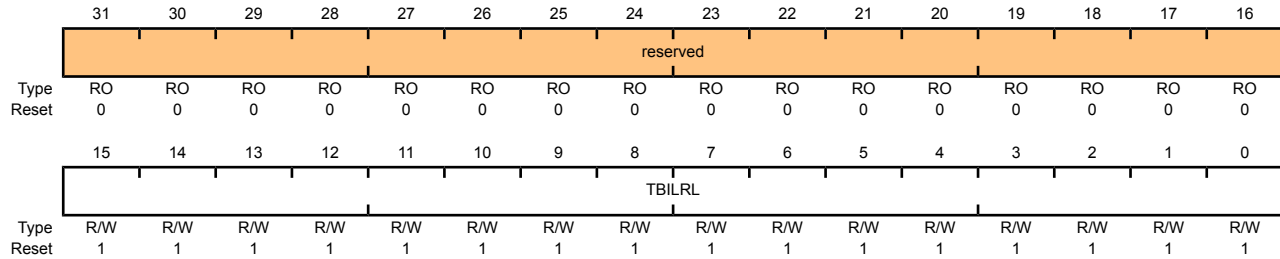


### Register 10: GPTM TimerB Interval Load (GPTMTBILR), offset 0x02C

This register is used to load the starting count value into TimerB. When the GPTM is configured to a 32-bit mode, **GPTMTBILR** returns the current value of TimerB and ignores writes.

#### GPTM TimerB Interval Load (GPTMTBILR)

Timer0 base: 0x4003.0000  
 Timer1 base: 0x4003.1000  
 Timer2 base: 0x4003.2000  
 Timer3 base: 0x4003.3000  
 Offset 0x02C  
 Type R/W, reset 0x0000.FFFF



Bit/Field	Name	Type	Reset	Description
31:16	reserved	RO	0x0000	Software should not rely on the value of a reserved bit. To provide compatibility with future products, the value of a reserved bit should be preserved across a read-modify-write operation.
15:0	TBILRL	R/W	0xFFFF	GPTM TimerB Interval Load Register

When the GPTM is not configured as a 32-bit timer, a write to this field updates **GPTMTBILR**. In 32-bit mode, writes are ignored, and reads return the current value of **GPTMTBILR**.

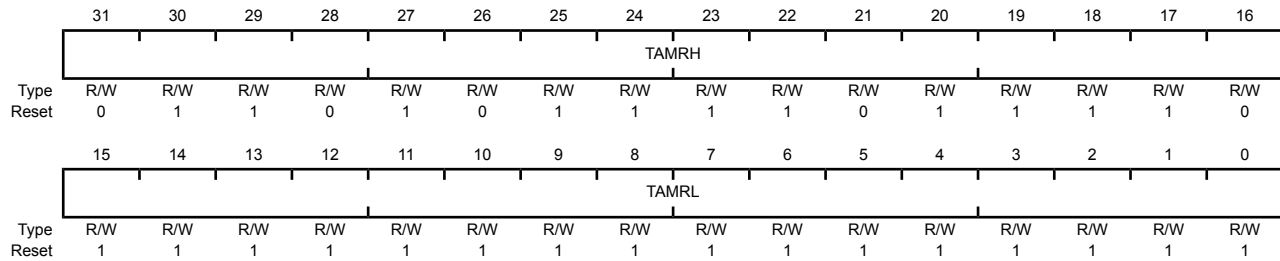
### Register 11: GPTM TimerA Match (GPTMTAMATCHR), offset 0x030

This register is used in 32-bit Real-Time Clock mode and 16-bit PWM and Input Edge Count modes.

#### GPTM TimerA Match (GPTMTAMATCHR)

Timer0 base: 0x4003.0000  
 Timer1 base: 0x4003.1000  
 Timer2 base: 0x4003.2000  
 Timer3 base: 0x4003.3000  
 Offset 0x030

Type R/W, reset 0x0000.FFFF (16-bit mode) and 0xFFFF.FFFF (32-bit mode)



Bit/Field	Name	Type	Reset	Description
31:16	TAMRH	R/W	0xFFFF (32-bit mode) 0x0000 (16-bit mode)	GPTM TimerA Match Register High  When configured for 32-bit Real-Time Clock (RTC) mode via the <b>GPTMCFG</b> register, this value is compared to the upper half of <b>GPTMTAR</b> , to determine match events.  In 16-bit mode, this field reads as 0 and does not have an effect on the state of <b>GPTMTBMATCHR</b> .
15:0	TAMRL	R/W	0xFFFF	GPTM TimerA Match Register Low  When configured for 32-bit Real-Time Clock (RTC) mode via the <b>GPTMCFG</b> register, this value is compared to the lower half of <b>GPTMTAR</b> , to determine match events.  When configured for PWM mode, this value along with <b>GPTMTAILR</b> , determines the duty cycle of the output PWM signal.  When configured for Edge Count mode, this value along with <b>GPTMTAILR</b> , determines how many edge events are counted. The total number of edge events counted is equal to the value in <b>GPTMTAILR</b> minus this value.

## Register 12: GPTM TimerB Match (GPTMTBMATCHR), offset 0x034

This register is used in 32-bit Real-Time Clock mode and 16-bit PWM and Input Edge Count modes.

### GPTM TimerB Match (GPTMTBMATCHR)

Timer0 base: 0x4003.0000  
 Timer1 base: 0x4003.1000  
 Timer2 base: 0x4003.2000  
 Timer3 base: 0x4003.3000  
 Offset 0x034  
 Type R/W, reset 0x0000.FFFF

	31	30	29	28	27	26	25	24	23	22	21	20	19	18	17	16
	reserved															
Type	RO	RO	RO	RO	RO	RO	RO	RO	RO	RO	RO	RO	RO	RO	RO	RO
Reset	0	0	0	0	0	0	0	0	0	0	0	0	0	0	0	0
	15	14	13	12	11	10	9	8	7	6	5	4	3	2	1	0
	TBMRL															
Type	R/W	R/W	R/W	R/W	R/W	R/W	R/W	R/W	R/W	R/W	R/W	R/W	R/W	R/W	R/W	R/W
Reset	1	1	1	1	1	1	1	1	1	1	1	1	1	1	1	1

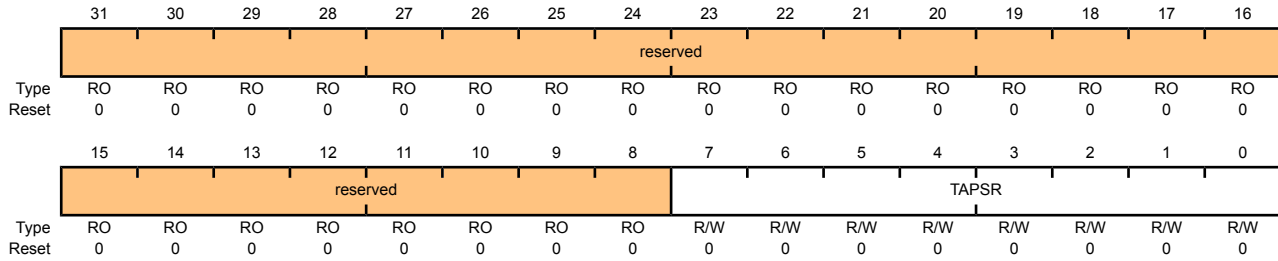
Bit/Field	Name	Type	Reset	Description
31:16	reserved	RO	0x0000	Software should not rely on the value of a reserved bit. To provide compatibility with future products, the value of a reserved bit should be preserved across a read-modify-write operation.
15:0	TBMRL	R/W	0xFFFF	GPTM TimerB Match Register Low  When configured for PWM mode, this value along with <b>GPTMTBILR</b> , determines the duty cycle of the output PWM signal.  When configured for Edge Count mode, this value along with <b>GPTMTBILR</b> , determines how many edge events are counted. The total number of edge events counted is equal to the value in <b>GPTMTBILR</b> minus this value.

### Register 13: GPTM TimerA Prescale (GPTMTAPR), offset 0x038

This register allows software to extend the range of the 16-bit timers when operating in one-shot or periodic mode.

#### GPTM TimerA Prescale (GPTMTAPR)

Timer0 base: 0x4003.0000  
 Timer1 base: 0x4003.1000  
 Timer2 base: 0x4003.2000  
 Timer3 base: 0x4003.3000  
 Offset 0x038  
 Type R/W, reset 0x0000.0000



Bit/Field	Name	Type	Reset	Description
31:8	reserved	RO	0x00	Software should not rely on the value of a reserved bit. To provide compatibility with future products, the value of a reserved bit should be preserved across a read-modify-write operation.
7:0	TAPSR	R/W	0x00	GPTM TimerA Prescale  The register loads this value on a write. A read returns the current value of the register.  Refer to Table 10-1 on page 202 for more details and an example.

**Register 14: GPTM TimerB Prescale (GPTMTBPR), offset 0x03C**

This register allows software to extend the range of the 16-bit timers when operating in one-shot or periodic mode.

**GPTM TimerB Prescale (GPTMTBPR)**

Timer0 base: 0x4003.0000  
 Timer1 base: 0x4003.1000  
 Timer2 base: 0x4003.2000  
 Timer3 base: 0x4003.3000  
 Offset 0x03C  
 Type R/W, reset 0x0000.0000

	31	30	29	28	27	26	25	24	23	22	21	20	19	18	17	16
	reserved															
Type	RO	RO	RO	RO	RO	RO	RO	RO	RO	RO	RO	RO	RO	RO	RO	RO
Reset	0	0	0	0	0	0	0	0	0	0	0	0	0	0	0	0
	15	14	13	12	11	10	9	8	7	6	5	4	3	2	1	0
	reserved								TBPSR							
Type	RO	RO	RO	RO	RO	RO	RO	RO	R/W	R/W	R/W	R/W	R/W	R/W	R/W	R/W
Reset	0	0	0	0	0	0	0	0	0	0	0	0	0	0	0	0

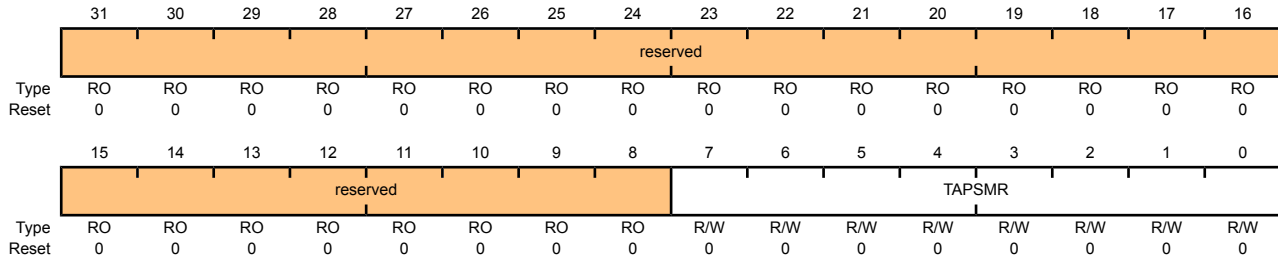
Bit/Field	Name	Type	Reset	Description
31:8	reserved	RO	0x00	Software should not rely on the value of a reserved bit. To provide compatibility with future products, the value of a reserved bit should be preserved across a read-modify-write operation.
7:0	TBPSR	R/W	0x00	GPTM TimerB Prescale  The register loads this value on a write. A read returns the current value of this register.  Refer to Table 10-1 on page 202 for more details and an example.

### Register 15: GPTM TimerA Prescale Match (GPTMTAPMR), offset 0x040

This register effectively extends the range of **GPTMTAMATCHR** to 24 bits when operating in 16-bit one-shot or periodic mode.

#### GPTM TimerA Prescale Match (GPTMTAPMR)

Timer0 base: 0x4003.0000  
 Timer1 base: 0x4003.1000  
 Timer2 base: 0x4003.2000  
 Timer3 base: 0x4003.3000  
 Offset 0x040  
 Type R/W, reset 0x0000.0000



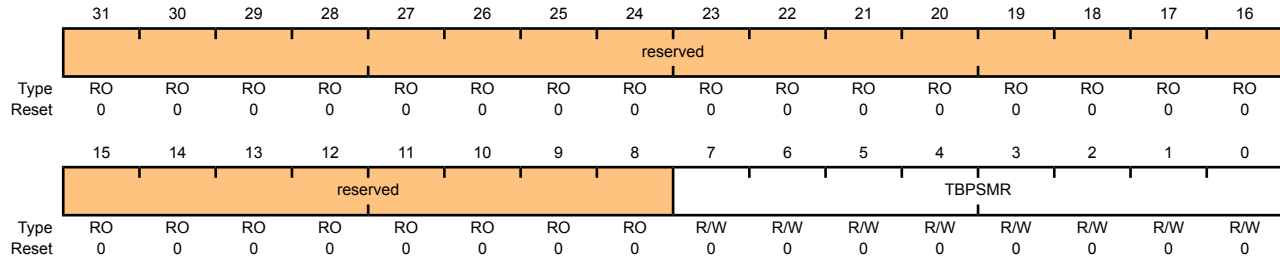
Bit/Field	Name	Type	Reset	Description
31:8	reserved	RO	0x00	Software should not rely on the value of a reserved bit. To provide compatibility with future products, the value of a reserved bit should be preserved across a read-modify-write operation.
7:0	TAPSMR	R/W	0x00	GPTM TimerA Prescale Match  This value is used alongside <b>GPTMTAMATCHR</b> to detect timer match events while using a prescaler.

### Register 16: GPTM TimerB Prescale Match (GPTMTBPMR), offset 0x044

This register effectively extends the range of **GPTMTBMATCHR** to 24 bits when operating in 16-bit one-shot or periodic mode.

#### GPTM TimerB Prescale Match (GPTMTBPMR)

Timer0 base: 0x4003.0000  
 Timer1 base: 0x4003.1000  
 Timer2 base: 0x4003.2000  
 Timer3 base: 0x4003.3000  
 Offset 0x044  
 Type R/W, reset 0x0000.0000



Bit/Field	Name	Type	Reset	Description
31:8	reserved	RO	0x00	Software should not rely on the value of a reserved bit. To provide compatibility with future products, the value of a reserved bit should be preserved across a read-modify-write operation.
7:0	TBPSMR	R/W	0x00	GPTM TimerB Prescale Match  This value is used alongside <b>GPTMTBMATCHR</b> to detect timer match events while using a prescaler.

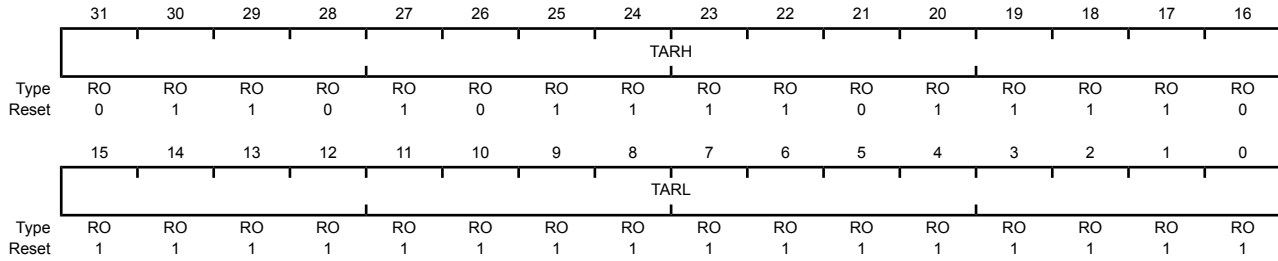
### Register 17: GPTM TimerA (GPTMTAR), offset 0x048

This register shows the current value of the TimerA counter in all cases except for Input Edge Count mode. When in this mode, this register contains the time at which the last edge event took place.

#### GPTM TimerA (GPTMTAR)

Timer0 base: 0x4003.0000  
 Timer1 base: 0x4003.1000  
 Timer2 base: 0x4003.2000  
 Timer3 base: 0x4003.3000  
 Offset 0x048

Type RO, reset 0x0000.FFFF (16-bit mode) and 0xFFFF.FFFF (32-bit mode)



Bit/Field	Name	Type	Reset	Description
31:16	TARH	RO	0xFFFF (32-bit mode) 0x0000 (16-bit mode)	GPTM TimerA Register High If the <b>GPTMCFG</b> is in a 32-bit mode, TimerB value is read. If the <b>GPTMCFG</b> is in a 16-bit mode, this is read as zero.
15:0	TARL	RO	0xFFFF	GPTM TimerA Register Low A read returns the current value of the <b>GPTM TimerA Count Register</b> , except in Input Edge Count mode, when it returns the timestamp from the last edge event.

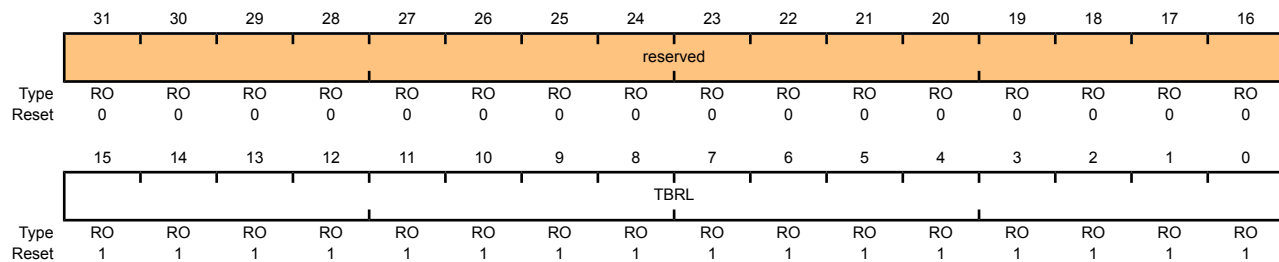


## Register 18: GPTM TimerB (GPTMTBR), offset 0x04C

This register shows the current value of the TimerB counter in all cases except for Input Edge Count mode. When in this mode, this register contains the time at which the last edge event took place.

### GPTM TimerB (GPTMTBR)

Timer0 base: 0x4003.0000  
 Timer1 base: 0x4003.1000  
 Timer2 base: 0x4003.2000  
 Timer3 base: 0x4003.3000  
 Offset 0x04C  
 Type RO, reset 0x0000.FFFF



Bit/Field	Name	Type	Reset	Description
31:16	reserved	RO	0x0000	Software should not rely on the value of a reserved bit. To provide compatibility with future products, the value of a reserved bit should be preserved across a read-modify-write operation.
15:0	TBRL	RO	0xFFFF	GPTM TimerB

A read returns the current value of the **GPTM TimerB Count Register**, except in Input Edge Count mode, when it returns the timestamp from the last edge event.

# 11 Watchdog Timer

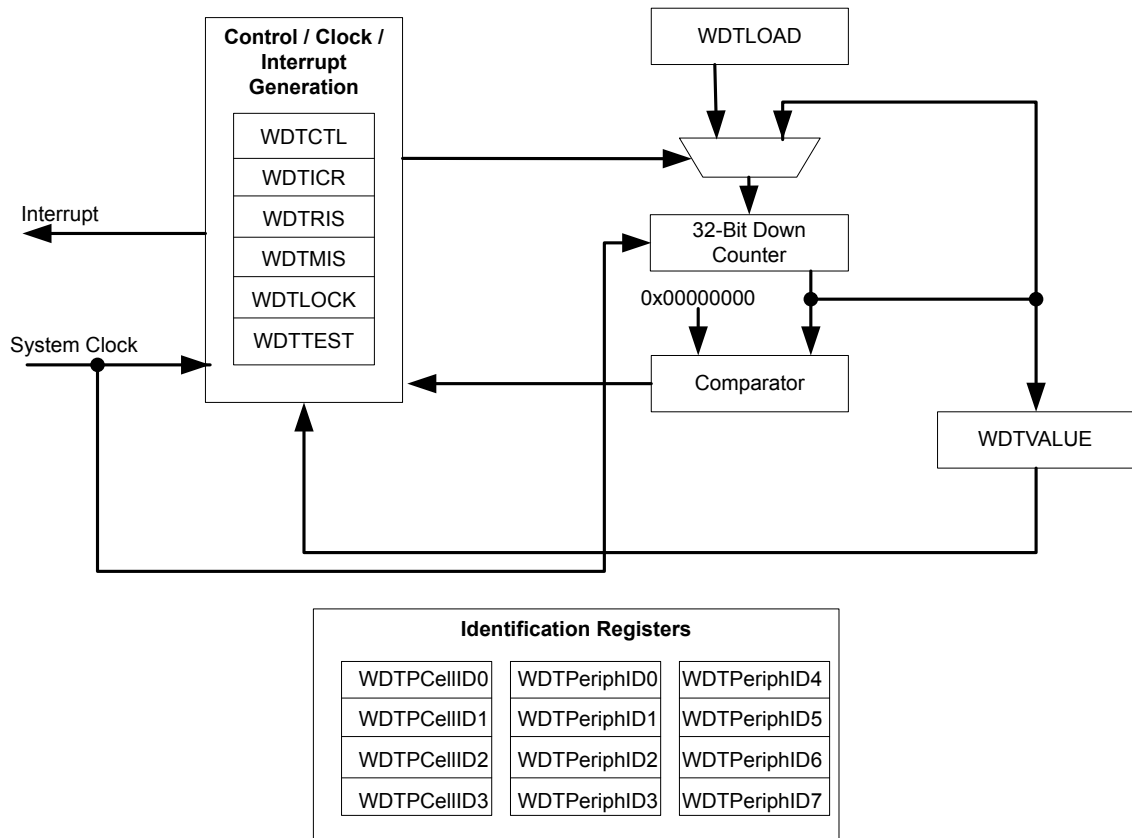
A watchdog timer can generate nonmaskable interrupts (NMIs) or a reset when a time-out value is reached. The watchdog timer is used to regain control when a system has failed due to a software error or due to the failure of an external device to respond in the expected way.

The Stellaris® Watchdog Timer module consists of a 32-bit down counter, a programmable load register, interrupt generation logic, a locking register, and user-enabled stalling.

The Watchdog Timer can be configured to generate an interrupt to the controller on its first time-out, and to generate a reset signal on its second time-out. Once the Watchdog Timer has been configured, the lock register can be written to prevent the timer configuration from being inadvertently altered.

## 11.1 Block Diagram

Figure 11-1. WDT Module Block Diagram



## 11.2 Functional Description

The Watchdog Timer module generates the first time-out signal when the 32-bit counter reaches the zero state after being enabled; enabling the counter also enables the watchdog timer interrupt. After the first time-out event, the 32-bit counter is re-loaded with the value of the **Watchdog Timer Load (WDTLOAD)** register, and the timer resumes counting down from that value. Once the

Watchdog Timer has been configured, the **Watchdog Timer Lock (WDTLOCK)** register is written, which prevents the timer configuration from being inadvertently altered by software.

If the timer counts down to its zero state again before the first time-out interrupt is cleared, and the reset signal has been enabled (via the `WatchdogResetEnable` function), the Watchdog timer asserts its reset signal to the system. If the interrupt is cleared before the 32-bit counter reaches its second time-out, the 32-bit counter is loaded with the value in the **WDTLOAD** register, and counting resumes from that value.

If **WDTLOAD** is written with a new value while the Watchdog Timer counter is counting, then the counter is loaded with the new value and continues counting.

Writing to **WDTLOAD** does not clear an active interrupt. An interrupt must be specifically cleared by writing to the **Watchdog Interrupt Clear (WDTICR)** register.

The Watchdog module interrupt and reset generation can be enabled or disabled as required. When the interrupt is re-enabled, the 32-bit counter is preloaded with the load register value and not its last state.

### 11.3 Initialization and Configuration

To use the WDT, its peripheral clock must be enabled by setting the `WDT` bit in the **RCGC0** register. The Watchdog Timer is configured using the following sequence:

1. Load the **WDTLOAD** register with the desired timer load value.
2. If the Watchdog is configured to trigger system resets, set the `RESEN` bit in the **WDTCTL** register.
3. Set the `INTEN` bit in the **WDTCTL** register to enable the Watchdog and lock the control register.

If software requires that all of the watchdog registers are locked, the Watchdog Timer module can be fully locked by writing any value to the **WDTLOCK** register. To unlock the Watchdog Timer, write a value of `0x1ACC.E551`.

### 11.4 Register Map

Table 11-1 on page 235 lists the Watchdog registers. The offset listed is a hexadecimal increment to the register's address, relative to the Watchdog Timer base address of `0x4000.0000`.

**Table 11-1. Watchdog Timer Register Map**

Offset	Name	Type	Reset	Description	See page
0x000	WDTLOAD	R/W	0xFFFF.FFFF	Watchdog Load	237
0x004	WDTVALUE	RO	0xFFFF.FFFF	Watchdog Value	238
0x008	WDTCTL	R/W	0x0000.0000	Watchdog Control	239
0x00C	WDTICR	WO	-	Watchdog Interrupt Clear	240
0x010	WDTRIS	RO	0x0000.0000	Watchdog Raw Interrupt Status	241
0x014	WDTMIS	RO	0x0000.0000	Watchdog Masked Interrupt Status	242
0x418	WDTTEST	R/W	0x0000.0000	Watchdog Test	243
0xC00	WDTLOCK	R/W	0x0000.0000	Watchdog Lock	244

Offset	Name	Type	Reset	Description	See page
0xFD0	WDTPeriphID4	RO	0x0000.0000	Watchdog Peripheral Identification 4	245
0xFD4	WDTPeriphID5	RO	0x0000.0000	Watchdog Peripheral Identification 5	246
0xFD8	WDTPeriphID6	RO	0x0000.0000	Watchdog Peripheral Identification 6	247
0xFDC	WDTPeriphID7	RO	0x0000.0000	Watchdog Peripheral Identification 7	248
0xFE0	WDTPeriphID0	RO	0x0000.0005	Watchdog Peripheral Identification 0	249
0xFE4	WDTPeriphID1	RO	0x0000.0018	Watchdog Peripheral Identification 1	250
0xFE8	WDTPeriphID2	RO	0x0000.0018	Watchdog Peripheral Identification 2	251
0xFEC	WDTPeriphID3	RO	0x0000.0001	Watchdog Peripheral Identification 3	252
0xFF0	WDTPCellID0	RO	0x0000.000D	Watchdog PrimeCell Identification 0	253
0xFF4	WDTPCellID1	RO	0x0000.00F0	Watchdog PrimeCell Identification 1	254
0xFF8	WDTPCellID2	RO	0x0000.0005	Watchdog PrimeCell Identification 2	255
0xFFC	WDTPCellID3	RO	0x0000.00B1	Watchdog PrimeCell Identification 3	256

## 11.5 Register Descriptions

The remainder of this section lists and describes the WDT registers, in numerical order by address offset.

## Register 1: Watchdog Load (WDTLOAD), offset 0x000

This register is the 32-bit interval value used by the 32-bit counter. When this register is written, the value is immediately loaded and the counter restarts counting down from the new value. If the **WDTLOAD** register is loaded with 0x0000.0000, an interrupt is immediately generated.

### Watchdog Load (WDTLOAD)

Base 0x4000.0000

Offset 0x000

Type R/W, reset 0xFFFF.FFFF

	31	30	29	28	27	26	25	24	23	22	21	20	19	18	17	16
	WDTLoad															
Type	R/W	R/W	R/W	R/W	R/W	R/W	R/W	R/W	R/W	R/W	R/W	R/W	R/W	R/W	R/W	R/W
Reset	1	1	1	1	1	1	1	1	1	1	1	1	1	1	1	1
	15	14	13	12	11	10	9	8	7	6	5	4	3	2	1	0
	WDTLoad															
Type	R/W	R/W	R/W	R/W	R/W	R/W	R/W	R/W	R/W	R/W	R/W	R/W	R/W	R/W	R/W	R/W
Reset	1	1	1	1	1	1	1	1	1	1	1	1	1	1	1	1

Bit/Field	Name	Type	Reset	Description
31:0	WDTLoad	R/W	0xFFFF.FFFF	Watchdog Load Value

## Register 2: Watchdog Value (WDTVALUE), offset 0x004

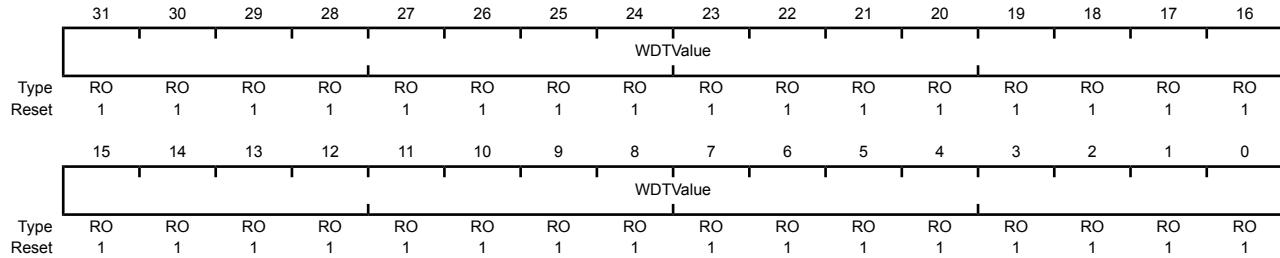
This register contains the current count value of the timer.

### Watchdog Value (WDTVALUE)

Base 0x4000.0000

Offset 0x004

Type RO, reset 0xFFFF.FFFF



Bit/Field	Name	Type	Reset	Description
31:0	WDTValue	RO	0xFFFF.FFFF	Watchdog Value Current value of the 32-bit down counter.

### Register 3: Watchdog Control (WDTCTL), offset 0x008

This register is the watchdog control register. The watchdog timer can be configured to generate a reset signal (on second time-out) or an interrupt on time-out.

When the watchdog interrupt has been enabled, all subsequent writes to the control register are ignored. The only mechanism that can re-enable writes is a hardware reset.

#### Watchdog Control (WDTCTL)

Base 0x4000.0000  
Offset 0x008  
Type R/W, reset 0x0000.0000

	31	30	29	28	27	26	25	24	23	22	21	20	19	18	17	16	
	reserved																
Type	RO	RO	RO	RO	RO	RO	RO	RO	RO	RO	RO	RO	RO	RO	RO	RO	
Reset	0	0	0	0	0	0	0	0	0	0	0	0	0	0	0	0	
	15	14	13	12	11	10	9	8	7	6	5	4	3	2	1	0	
	reserved														RESEN	INTEN	
Type	RO	RO	RO	RO	RO	RO	RO	RO	RO	RO	RO	RO	RO	RO	RO	R/W	R/W
Reset	0	0	0	0	0	0	0	0	0	0	0	0	0	0	0	0	0

Bit/Field	Name	Type	Reset	Description						
31:2	reserved	RO	0x00	Software should not rely on the value of a reserved bit. To provide compatibility with future products, the value of a reserved bit should be preserved across a read-modify-write operation.						
1	RESEN	R/W	0	Watchdog Reset Enable  The <b>RESEN</b> values are defined as follows:  <table border="1"> <thead> <tr> <th>Value</th> <th>Description</th> </tr> </thead> <tbody> <tr> <td>0</td> <td>Disabled.</td> </tr> <tr> <td>1</td> <td>Enable the Watchdog module reset output.</td> </tr> </tbody> </table>	Value	Description	0	Disabled.	1	Enable the Watchdog module reset output.
Value	Description									
0	Disabled.									
1	Enable the Watchdog module reset output.									
0	INTEN	R/W	0	Watchdog Interrupt Enable  The <b>INTEN</b> values are defined as follows:  <table border="1"> <thead> <tr> <th>Value</th> <th>Description</th> </tr> </thead> <tbody> <tr> <td>0</td> <td>Interrupt event disabled (once this bit is set, it can only be cleared by a hardware reset).</td> </tr> <tr> <td>1</td> <td>Interrupt event enabled. Once enabled, all writes are ignored.</td> </tr> </tbody> </table>	Value	Description	0	Interrupt event disabled (once this bit is set, it can only be cleared by a hardware reset).	1	Interrupt event enabled. Once enabled, all writes are ignored.
Value	Description									
0	Interrupt event disabled (once this bit is set, it can only be cleared by a hardware reset).									
1	Interrupt event enabled. Once enabled, all writes are ignored.									

### Register 4: Watchdog Interrupt Clear (WDTICR), offset 0x00C

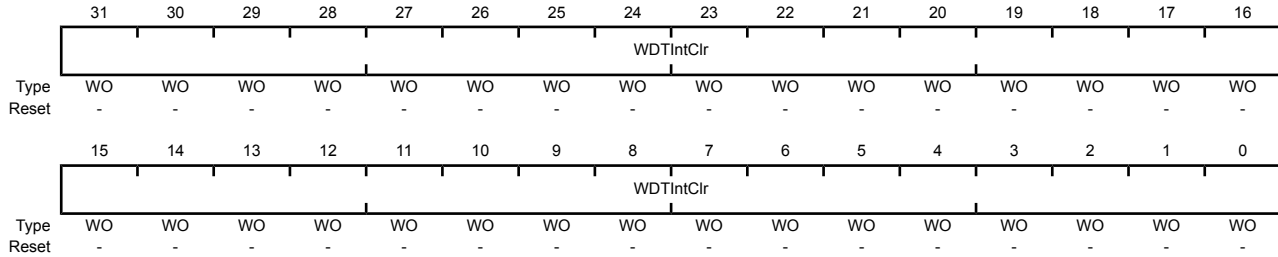
This register is the interrupt clear register. A write of any value to this register clears the Watchdog interrupt and reloads the 32-bit counter from the **WDTLOAD** register. Value for a read or reset is indeterminate.

#### Watchdog Interrupt Clear (WDTICR)

Base 0x4000.0000

Offset 0x00C

Type WO, reset -



Bit/Field	Name	Type	Reset	Description
31:0	WDTIntClr	WO	-	Watchdog Interrupt Clear

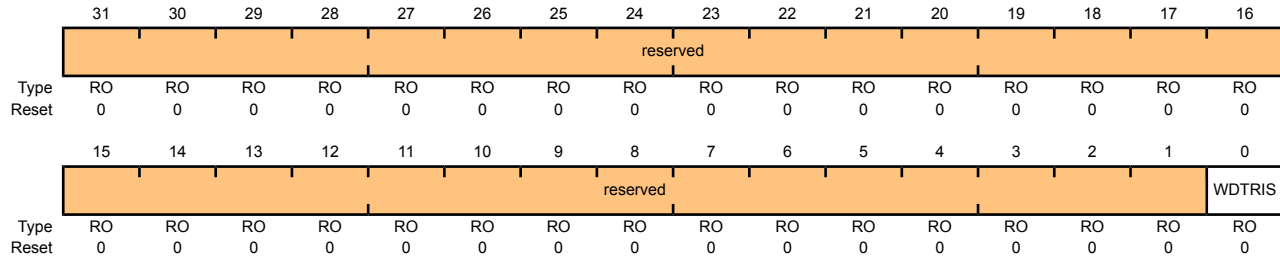


### Register 5: Watchdog Raw Interrupt Status (WDTRIS), offset 0x010

This register is the raw interrupt status register. Watchdog interrupt events can be monitored via this register if the controller interrupt is masked.

#### Watchdog Raw Interrupt Status (WDTRIS)

Base 0x4000.0000  
 Offset 0x010  
 Type RO, reset 0x0000.0000



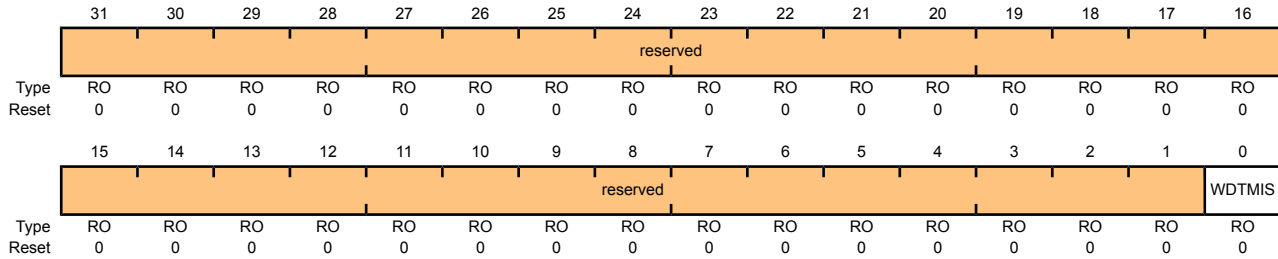
Bit/Field	Name	Type	Reset	Description
31:1	reserved	RO	0x00	Software should not rely on the value of a reserved bit. To provide compatibility with future products, the value of a reserved bit should be preserved across a read-modify-write operation.
0	WDTRIS	RO	0	Watchdog Raw Interrupt Status Gives the raw interrupt state (prior to masking) of <b>WDTINTR</b> .

### Register 6: Watchdog Masked Interrupt Status (WDTMIS), offset 0x014

This register is the masked interrupt status register. The value of this register is the logical AND of the raw interrupt bit and the Watchdog interrupt enable bit.

#### Watchdog Masked Interrupt Status (WDTMIS)

Base 0x4000.0000  
 Offset 0x014  
 Type RO, reset 0x0000.0000



Bit/Field	Name	Type	Reset	Description
31:1	reserved	RO	0x00	Software should not rely on the value of a reserved bit. To provide compatibility with future products, the value of a reserved bit should be preserved across a read-modify-write operation.
0	WDTMIS	RO	0	Watchdog Masked Interrupt Status  Gives the masked interrupt state (after masking) of the <b>WDTINTR</b> interrupt.

**Register 7: Watchdog Test (WDTTEST), offset 0x418**

This register provides user-enabled stalling when the microcontroller asserts the CPU halt flag during debug.

**Watchdog Test (WDTTEST)**

Base 0x4000.0000

Offset 0x418

Type R/W, reset 0x0000.0000

	31	30	29	28	27	26	25	24	23	22	21	20	19	18	17	16
	reserved															
Type	RO	RO	RO	RO	RO	RO	RO	RO	RO	RO	RO	RO	RO	RO	RO	RO
Reset	0	0	0	0	0	0	0	0	0	0	0	0	0	0	0	0
	15	14	13	12	11	10	9	8	7	6	5	4	3	2	1	0
	reserved							STALL	reserved							
Type	RO	RO	RO	RO	RO	RO	RO	R/W	RO	RO	RO	RO	RO	RO	RO	RO
Reset	0	0	0	0	0	0	0	0	0	0	0	0	0	0	0	0

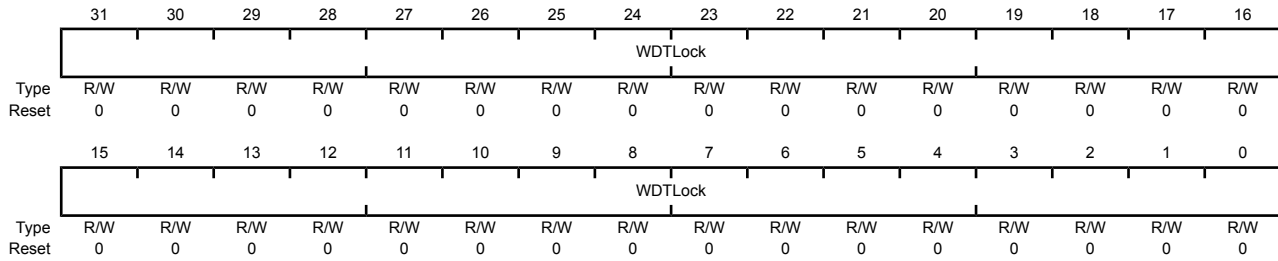
Bit/Field	Name	Type	Reset	Description
31:9	reserved	RO	0x00	Software should not rely on the value of a reserved bit. To provide compatibility with future products, the value of a reserved bit should be preserved across a read-modify-write operation.
8	STALL	R/W	0	<p>Watchdog Stall Enable</p> <p>When set to 1, if the Stellaris<sup>®</sup> microcontroller is stopped with a debugger, the watchdog timer stops counting. Once the microcontroller is restarted, the watchdog timer resumes counting.</p>
7:0	reserved	RO	0x00	Software should not rely on the value of a reserved bit. To provide compatibility with future products, the value of a reserved bit should be preserved across a read-modify-write operation.

### Register 8: Watchdog Lock (WDTLOCK), offset 0xC00

Writing 0x1ACC.E551 to the **WDTLOCK** register enables write access to all other registers. Writing any other value to the **WDTLOCK** register re-enables the locked state for register writes to all the other registers. Reading the **WDTLOCK** register returns the lock status rather than the 32-bit value written. Therefore, when write accesses are disabled, reading the **WDTLOCK** register returns 0x0000.0001 (when locked; otherwise, the returned value is 0x0000.0000 (unlocked)).

#### Watchdog Lock (WDTLOCK)

Base 0x4000.0000  
 Offset 0xC00  
 Type R/W, reset 0x0000.0000



Bit/Field	Name	Type	Reset	Description
31:0	WDTLock	R/W	0x0000	Watchdog Lock

A write of the value 0x1ACC.E551 unlocks the watchdog registers for write access. A write of any other value reapplies the lock, preventing any register updates.

A read of this register returns the following values:

Value	Description
0x0000.0001	Locked
0x0000.0000	Unlocked

**Register 9: Watchdog Peripheral Identification 4 (WDTPeriphID4), offset 0xFD0**

The **WDTPeriphIDn** registers are hard-coded and the fields within the register determine the reset value.

## Watchdog Peripheral Identification 4 (WDTPeriphID4)

Base 0x4000.0000

Offset 0xFD0

Type RO, reset 0x0000.0000

	31	30	29	28	27	26	25	24	23	22	21	20	19	18	17	16
	reserved															
Type	RO	RO	RO	RO	RO	RO	RO	RO	RO	RO	RO	RO	RO	RO	RO	RO
Reset	0	0	0	0	0	0	0	0	0	0	0	0	0	0	0	0
	15	14	13	12	11	10	9	8	7	6	5	4	3	2	1	0
	reserved								PID4							
Type	RO	RO	RO	RO	RO	RO	RO	RO	RO	RO	RO	RO	RO	RO	RO	RO
Reset	0	0	0	0	0	0	0	0	0	0	0	0	0	0	0	0

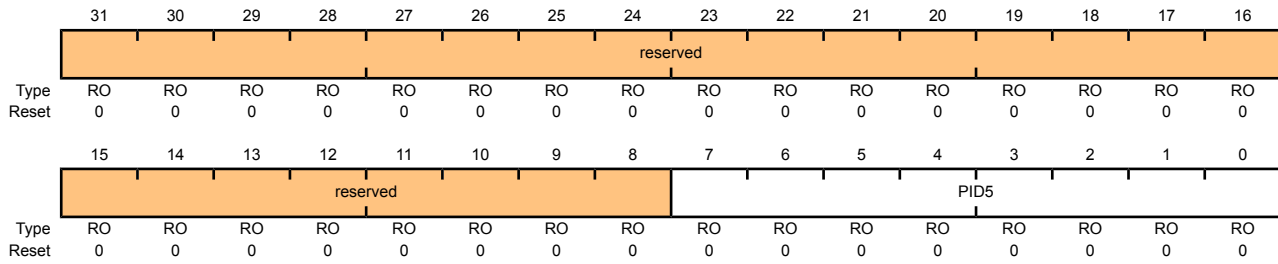
Bit/Field	Name	Type	Reset	Description
31:8	reserved	RO	0x00	Software should not rely on the value of a reserved bit. To provide compatibility with future products, the value of a reserved bit should be preserved across a read-modify-write operation.
7:0	PID4	RO	0x00	WDT Peripheral ID Register[7:0]

## Register 10: Watchdog Peripheral Identification 5 (WDTPeriphID5), offset 0xFD4

The **WDTPeriphIDn** registers are hard-coded and the fields within the register determine the reset value.

### Watchdog Peripheral Identification 5 (WDTPeriphID5)

Base 0x4000.0000  
 Offset 0xFD4  
 Type RO, reset 0x0000.0000



Bit/Field	Name	Type	Reset	Description
31:8	reserved	RO	0x00	Software should not rely on the value of a reserved bit. To provide compatibility with future products, the value of a reserved bit should be preserved across a read-modify-write operation.
7:0	PID5	RO	0x00	WDT Peripheral ID Register[15:8]

## Register 11: Watchdog Peripheral Identification 6 (WDTPeriphID6), offset 0xFD8

The **WDTPeriphIDn** registers are hard-coded and the fields within the register determine the reset value.

### Watchdog Peripheral Identification 6 (WDTPeriphID6)

Base 0x4000.0000

Offset 0xFD8

Type RO, reset 0x0000.0000

	31	30	29	28	27	26	25	24	23	22	21	20	19	18	17	16
	reserved															
Type	RO	RO	RO	RO	RO	RO	RO	RO	RO	RO	RO	RO	RO	RO	RO	RO
Reset	0	0	0	0	0	0	0	0	0	0	0	0	0	0	0	0
	15	14	13	12	11	10	9	8	7	6	5	4	3	2	1	0
	reserved								PID6							
Type	RO	RO	RO	RO	RO	RO	RO	RO	RO	RO	RO	RO	RO	RO	RO	RO
Reset	0	0	0	0	0	0	0	0	0	0	0	0	0	0	0	0

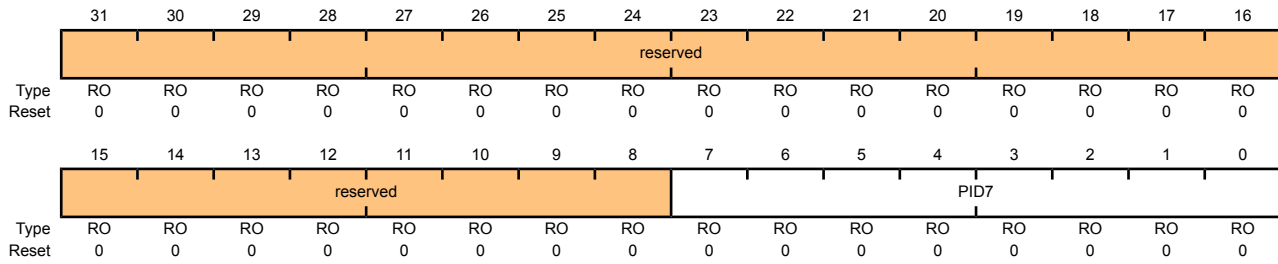
Bit/Field	Name	Type	Reset	Description
31:8	reserved	RO	0x00	Software should not rely on the value of a reserved bit. To provide compatibility with future products, the value of a reserved bit should be preserved across a read-modify-write operation.
7:0	PID6	RO	0x00	WDT Peripheral ID Register[23:16]

## Register 12: Watchdog Peripheral Identification 7 (WDTPeriphID7), offset 0xFDC

The **WDTPeriphIDn** registers are hard-coded and the fields within the register determine the reset value.

### Watchdog Peripheral Identification 7 (WDTPeriphID7)

Base 0x4000.0000  
 Offset 0xFDC  
 Type RO, reset 0x0000.0000



Bit/Field	Name	Type	Reset	Description
31:8	reserved	RO	0x00	Software should not rely on the value of a reserved bit. To provide compatibility with future products, the value of a reserved bit should be preserved across a read-modify-write operation.
7:0	PID7	RO	0x00	WDT Peripheral ID Register[31:24]



## Register 13: Watchdog Peripheral Identification 0 (WDTPeriphID0), offset 0xFE0

The **WDTPeriphIDn** registers are hard-coded and the fields within the register determine the reset value.

### Watchdog Peripheral Identification 0 (WDTPeriphID0)

Base 0x4000.0000

Offset 0xFE0

Type RO, reset 0x0000.0005

	31	30	29	28	27	26	25	24	23	22	21	20	19	18	17	16
	reserved															
Type	RO	RO	RO	RO	RO	RO	RO	RO	RO	RO	RO	RO	RO	RO	RO	RO
Reset	0	0	0	0	0	0	0	0	0	0	0	0	0	0	0	0
	15	14	13	12	11	10	9	8	7	6	5	4	3	2	1	0
	reserved								PID0							
Type	RO	RO	RO	RO	RO	RO	RO	RO	RO	RO	RO	RO	RO	RO	RO	RO
Reset	0	0	0	0	0	0	0	0	0	0	0	0	0	1	0	1

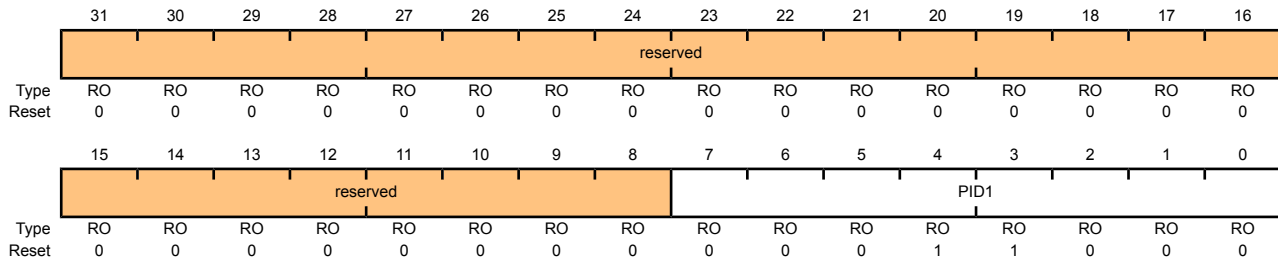
Bit/Field	Name	Type	Reset	Description
31:8	reserved	RO	0x00	Software should not rely on the value of a reserved bit. To provide compatibility with future products, the value of a reserved bit should be preserved across a read-modify-write operation.
7:0	PID0	RO	0x05	Watchdog Peripheral ID Register[7:0]

### Register 14: Watchdog Peripheral Identification 1 (WDTPeriphID1), offset 0xFE4

The **WDTPeriphIDn** registers are hard-coded and the fields within the register determine the reset value.

#### Watchdog Peripheral Identification 1 (WDTPeriphID1)

Base 0x4000.0000  
 Offset 0xFE4  
 Type RO, reset 0x0000.0018



Bit/Field	Name	Type	Reset	Description
31:8	reserved	RO	0x00	Software should not rely on the value of a reserved bit. To provide compatibility with future products, the value of a reserved bit should be preserved across a read-modify-write operation.
7:0	PID1	RO	0x18	Watchdog Peripheral ID Register[15:8]

## Register 15: Watchdog Peripheral Identification 2 (WDTPeriphID2), offset 0xFE8

The **WDTPeriphIDn** registers are hard-coded and the fields within the register determine the reset value.

### Watchdog Peripheral Identification 2 (WDTPeriphID2)

Base 0x4000.0000

Offset 0xFE8

Type RO, reset 0x0000.0018

	31	30	29	28	27	26	25	24	23	22	21	20	19	18	17	16
	reserved															
Type	RO	RO	RO	RO	RO	RO	RO	RO	RO	RO	RO	RO	RO	RO	RO	RO
Reset	0	0	0	0	0	0	0	0	0	0	0	0	0	0	0	0
	15	14	13	12	11	10	9	8	7	6	5	4	3	2	1	0
	reserved								PID2							
Type	RO	RO	RO	RO	RO	RO	RO	RO	RO	RO	RO	RO	RO	RO	RO	RO
Reset	0	0	0	0	0	0	0	0	0	0	0	1	1	0	0	0

Bit/Field	Name	Type	Reset	Description
31:8	reserved	RO	0x00	Software should not rely on the value of a reserved bit. To provide compatibility with future products, the value of a reserved bit should be preserved across a read-modify-write operation.
7:0	PID2	RO	0x18	Watchdog Peripheral ID Register[23:16]

## Register 16: Watchdog Peripheral Identification 3 (WDTPeriphID3), offset 0xFEC

The **WDTPeriphIDn** registers are hard-coded and the fields within the register determine the reset value.

### Watchdog Peripheral Identification 3 (WDTPeriphID3)

Base 0x4000.0000

Offset 0xFEC

Type RO, reset 0x0000.0001

	31	30	29	28	27	26	25	24	23	22	21	20	19	18	17	16
	reserved															
Type	RO	RO	RO	RO	RO	RO	RO	RO	RO	RO	RO	RO	RO	RO	RO	RO
Reset	0	0	0	0	0	0	0	0	0	0	0	0	0	0	0	0
	15	14	13	12	11	10	9	8	7	6	5	4	3	2	1	0
	reserved								PID3							
Type	RO	RO	RO	RO	RO	RO	RO	RO	RO	RO	RO	RO	RO	RO	RO	RO
Reset	0	0	0	0	0	0	0	0	0	0	0	0	0	0	0	1

Bit/Field	Name	Type	Reset	Description
31:8	reserved	RO	0x00	Software should not rely on the value of a reserved bit. To provide compatibility with future products, the value of a reserved bit should be preserved across a read-modify-write operation.
7:0	PID3	RO	0x01	Watchdog Peripheral ID Register[31:24]

**Register 17: Watchdog PrimeCell Identification 0 (WDTPCellID0), offset 0xFF0**

The **WDTPCellIDn** registers are hard-coded and the fields within the register determine the reset value.

## Watchdog PrimeCell Identification 0 (WDTPCellID0)

Base 0x4000.0000

Offset 0xFF0

Type RO, reset 0x0000.000D

	31	30	29	28	27	26	25	24	23	22	21	20	19	18	17	16
	reserved															
Type	RO	RO	RO	RO	RO	RO	RO	RO	RO	RO	RO	RO	RO	RO	RO	RO
Reset	0	0	0	0	0	0	0	0	0	0	0	0	0	0	0	0
	15	14	13	12	11	10	9	8	7	6	5	4	3	2	1	0
	reserved								CID0							
Type	RO	RO	RO	RO	RO	RO	RO	RO	RO	RO	RO	RO	RO	RO	RO	RO
Reset	0	0	0	0	0	0	0	0	0	0	0	0	1	1	0	1

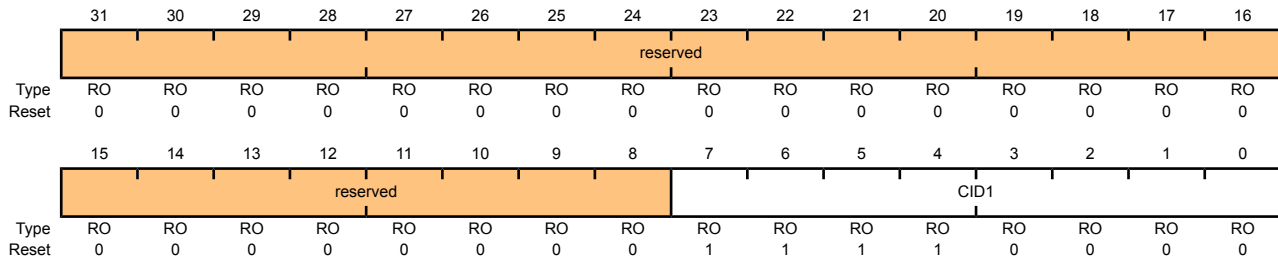
Bit/Field	Name	Type	Reset	Description
31:8	reserved	RO	0x00	Software should not rely on the value of a reserved bit. To provide compatibility with future products, the value of a reserved bit should be preserved across a read-modify-write operation.
7:0	CID0	RO	0x0D	Watchdog PrimeCell ID Register[7:0]

### Register 18: Watchdog PrimeCell Identification 1 (WDTPCellID1), offset 0xFF4

The **WDTPCellIDn** registers are hard-coded and the fields within the register determine the reset value.

#### Watchdog PrimeCell Identification 1 (WDTPCellID1)

Base 0x4000.0000  
 Offset 0xFF4  
 Type RO, reset 0x0000.00F0



Bit/Field	Name	Type	Reset	Description
31:8	reserved	RO	0x00	Software should not rely on the value of a reserved bit. To provide compatibility with future products, the value of a reserved bit should be preserved across a read-modify-write operation.
7:0	CID1	RO	0xF0	Watchdog PrimeCell ID Register[15:8]

**Register 19: Watchdog PrimeCell Identification 2 (WDTPCellID2), offset 0xFF8**

The **WDTPCellIDn** registers are hard-coded and the fields within the register determine the reset value.

## Watchdog PrimeCell Identification 2 (WDTPCellID2)

Base 0x4000.0000

Offset 0xFF8

Type RO, reset 0x0000.0005

	31	30	29	28	27	26	25	24	23	22	21	20	19	18	17	16
	reserved															
Type	RO	RO	RO	RO	RO	RO	RO	RO	RO	RO	RO	RO	RO	RO	RO	RO
Reset	0	0	0	0	0	0	0	0	0	0	0	0	0	0	0	0
	15	14	13	12	11	10	9	8	7	6	5	4	3	2	1	0
	reserved								CID2							
Type	RO	RO	RO	RO	RO	RO	RO	RO	RO	RO	RO	RO	RO	RO	RO	RO
Reset	0	0	0	0	0	0	0	0	0	0	0	0	0	1	0	1

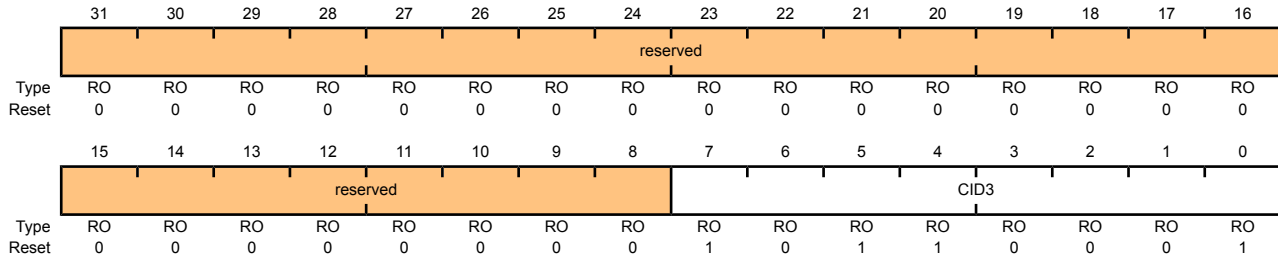
Bit/Field	Name	Type	Reset	Description
31:8	reserved	RO	0x00	Software should not rely on the value of a reserved bit. To provide compatibility with future products, the value of a reserved bit should be preserved across a read-modify-write operation.
7:0	CID2	RO	0x05	Watchdog PrimeCell ID Register[23:16]

### Register 20: Watchdog PrimeCell Identification 3 (WDTPCellID3), offset 0xFFC

The **WDTPCellIDn** registers are hard-coded and the fields within the register determine the reset value.

#### Watchdog PrimeCell Identification 3 (WDTPCellID3)

Base 0x4000.0000  
 Offset 0xFFC  
 Type RO, reset 0x0000.00B1



Bit/Field	Name	Type	Reset	Description
31:8	reserved	RO	0x00	Software should not rely on the value of a reserved bit. To provide compatibility with future products, the value of a reserved bit should be preserved across a read-modify-write operation.
7:0	CID3	RO	0xB1	Watchdog PrimeCell ID Register[31:24]



## 12 Analog-to-Digital Converter (ADC)

An analog-to-digital converter (ADC) is a peripheral that converts a continuous analog voltage to a discrete digital number.

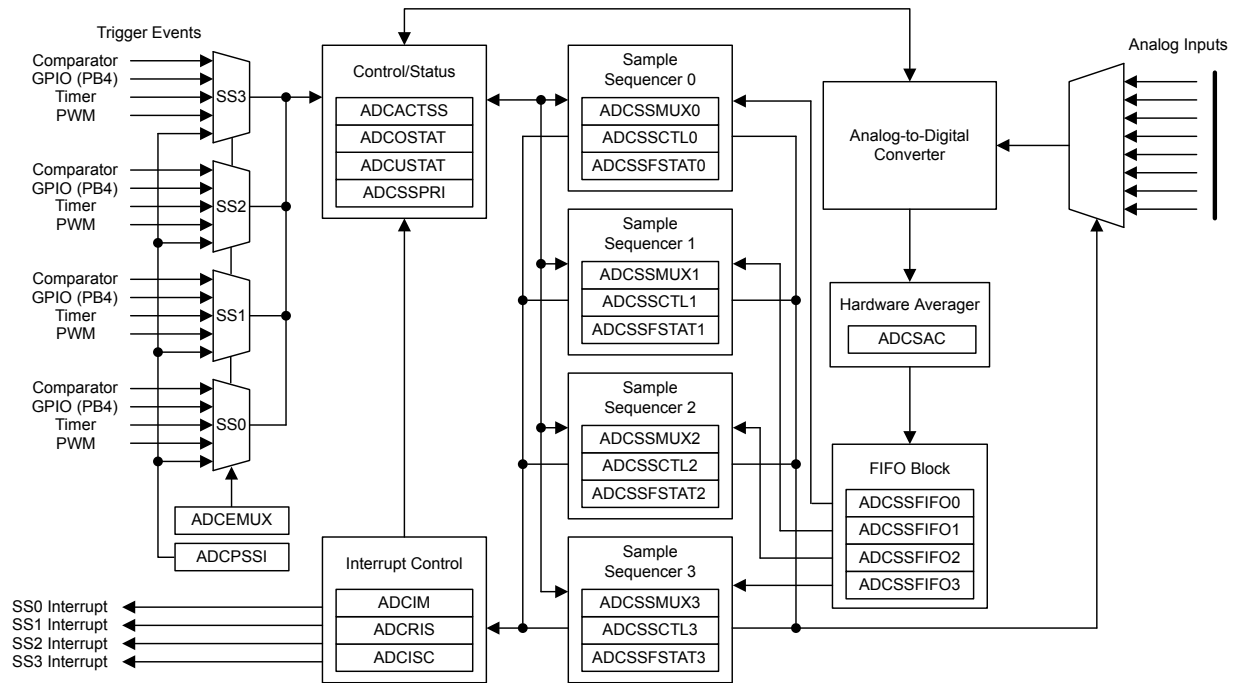
The Stellaris<sup>®</sup> ADC module features 10-bit conversion resolution and supports eight input channels, plus an internal temperature sensor. The ADC module contains a programmable sequencer which allows for the sampling of multiple analog input sources without controller intervention. Each sample sequence provides flexible programming with fully configurable input source, trigger events, interrupt generation, and sequence priority.

The Stellaris<sup>®</sup> ADC provides the following features:

- Eight analog input channels
- Single-ended and differential-input configurations
- Internal temperature sensor
- Sample rate of one million samples/second
- Four programmable sample conversion sequences from one to eight entries long, with corresponding conversion result FIFOs
- Flexible trigger control
  - Controller (software)
  - Timers
  - Analog Comparators
  - GPIO
- Hardware averaging of up to 64 samples for improved accuracy

## 12.1 Block Diagram

Figure 12-1. ADC Module Block Diagram



## 12.2 Functional Description

The Stellaris<sup>®</sup> ADC collects sample data by using a programmable sequence-based approach instead of the traditional single or double-sampling approach found on many ADC modules. Each *sample sequence* is a fully programmed series of consecutive (back-to-back) samples, allowing the ADC to collect data from multiple input sources without having to be re-configured or serviced by the controller. The programming of each sample in the sample sequence includes parameters such as the input source and mode (differential versus single-ended input), interrupt generation on sample completion, and the indicator for the last sample in the sequence.

### 12.2.1 Sample Sequencers

The sampling control and data capture is handled by the Sample Sequencers. All of the sequencers are identical in implementation except for the number of samples that can be captured and the depth of the FIFO. Table 12-1 on page 258 shows the maximum number of samples that each Sequencer can capture and its corresponding FIFO depth. In this implementation, each FIFO entry is a 32-bit word, with the lower 10 bits containing the conversion result.

Table 12-1. Samples and FIFO Depth of Sequencers

Sequencer	Number of Samples	Depth of FIFO
SS3	1	1
SS2	4	4
SS1	4	4
SS0	8	8

For a given sample sequence, each sample is defined by two 4-bit nibbles in the **ADC Sample Sequence Input Multiplexer Select (ADCSSMUXn)** and **ADC Sample Sequence Control (ADCSSCTLn)** registers, where "n" corresponds to the sequence number. The **ADCSSMUXn** nibbles select the input pin, while the **ADCSSCTLn** nibbles contain the sample control bits corresponding to parameters such as temperature sensor selection, interrupt enable, end of sequence, and differential input mode. Sample Sequencers are enabled by setting the respective **ASENn** bit in the **ADC Active Sample Sequencer (ADCACTSS)** register, but can be configured before being enabled.

When configuring a sample sequence, multiple uses of the same input pin within the same sequence is allowed. In the **ADCSSCTLn** register, the **Interrupt Enable (IE)** bits can be set for any combination of samples, allowing interrupts to be generated after every sample in the sequence if necessary. Also, the **END** bit can be set at any point within a sample sequence. For example, if Sequencer 0 is used, the **END** bit can be set in the nibble associated with the fifth sample, allowing Sequencer 0 to complete execution of the sample sequence after the fifth sample.

After a sample sequence completes execution, the result data can be retrieved from the **ADC Sample Sequence Result FIFO (ADCSSFIFO)** registers. The FIFOs are simple circular buffers that read a single address to "pop" result data. For software debug purposes, the positions of the FIFO head and tail pointers are visible in the **ADC Sample Sequence FIFO Status (ADCSSFSTATn)** registers along with **FULL** and **EMPTY** status flags. Overflow and underflow conditions are monitored using the **ADCSTAT** and **ADCUSTAT** registers.

## 12.2.2 Module Control

Outside of the Sample Sequencers, the remainder of the control logic is responsible for tasks such as interrupt generation, sequence prioritization, and trigger configuration.

Most of the ADC control logic runs at the ADC clock rate of 14-18 MHz. The internal ADC divider is configured automatically by hardware when the system **XTAL** is selected. The automatic clock divider configuration targets 16.667 MHz operation for all Stellaris® devices.

### 12.2.2.1 Interrupts

The Sample Sequencers dictate the events that cause interrupts, but they don't have control over whether the interrupt is actually sent to the interrupt controller. The ADC module's interrupt signal is controlled by the state of the **MASK** bits in the **ADC Interrupt Mask (ADCIM)** register. Interrupt status can be viewed at two locations: the **ADC Raw Interrupt Status (ADCRIS)** register, which shows the raw status of a Sample Sequencer's interrupt signal, and the **ADC Interrupt Status and Clear (ADCISC)** register, which shows the logical AND of the **ADCRIS** register's **INR** bit and the **ADCIM** register's **MASK** bits. Interrupts are cleared by writing a 1 to the corresponding **IN** bit in **ADCISC**.

### 12.2.2.2 Prioritization

When sampling events (triggers) happen concurrently, they are prioritized for processing by the values in the **ADC Sample Sequencer Priority (ADCSSPRI)** register. Valid priority values are in the range of 0-3, with 0 being the highest priority and 3 being the lowest. Multiple active Sample Sequencer units with the same priority do not provide consistent results, so software must ensure that all active Sample Sequencer units have a unique priority value.

### 12.2.2.3 Sampling Events

Sample triggering for each Sample Sequencer is defined in the **ADC Event Multiplexer Select (ADCEMUX)** register. The external peripheral triggering sources vary by Stellaris® family member,

but all devices share the "Controller" and "Always" triggers. Software can initiate sampling by setting the  $CH$  bits in the **ADC Processor Sample Sequence Initiate (ADCPSSI)** register.

When using the "Always" trigger, care must be taken. If a sequence's priority is too high, it is possible to starve other lower priority sequences.

### 12.2.3 Hardware Sample Averaging Circuit

Higher precision results can be generated using the hardware averaging circuit, however, the improved results are at the cost of throughput. Up to 64 samples can be accumulated and averaged to form a single data entry in the sequencer FIFO. Throughput is decreased proportionally to the number of samples in the averaging calculation. For example, if the averaging circuit is configured to average 16 samples, the throughput is decreased by a factor of 16.

By default the averaging circuit is off and all data from the converter passes through to the sequencer FIFO. The averaging hardware is controlled by the **ADC Sample Averaging Control (ADCSAC)** register (see page 275). There is a single averaging circuit and all input channels receive the same amount of averaging whether they are single-ended or differential.

### 12.2.4 Analog-to-Digital Converter

The converter itself generates a 10-bit output value for selected analog input. Special analog pads are used to minimize the distortion on the input.

### 12.2.5 Test Modes

There is a user-available test mode that allows for loopback operation within the digital portion of the ADC module. This can be useful for debugging software without having to provide actual analog stimulus. This mode is available through the **ADC Test Mode Loopback (ADCTMLB)** register (see page 288).

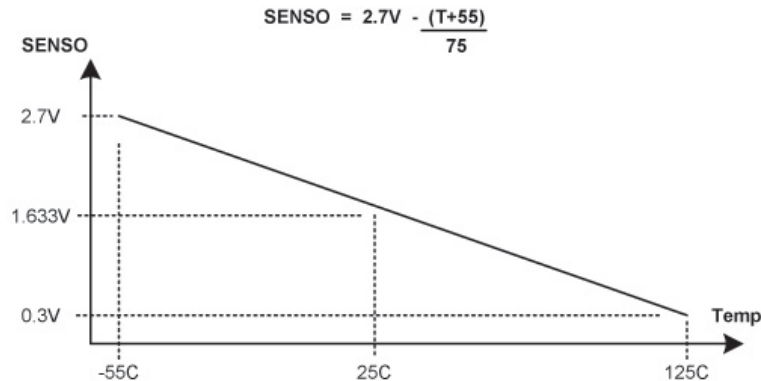
### 12.2.6 Internal Temperature Sensor

The internal temperature sensor provides an analog temperature reading as well as a reference voltage. The voltage at the output terminal  $SENSO$  is given by the following equation:

$$SENSO = 2.7 - ((T + 55) / 75)$$

This relation is shown in Figure 12-2 on page 261.

Figure 12-2. Internal Temperature Sensor Characteristic



## 12.3 Initialization and Configuration

In order for the ADC module to be used, the PLL must be enabled and using a supported crystal frequency (see the **RCC** register). Using unsupported frequencies can cause faulty operation in the ADC module.

### 12.3.1 Module Initialization

Initialization of the ADC module is a simple process with very few steps. The main steps include enabling the clock to the ADC and reconfiguring the Sample Sequencer priorities (if needed).

The initialization sequence for the ADC is as follows:

1. Enable the ADC clock by writing a value of 0x0001.0000 to the **RCGC1** register (see page 95).
2. If required by the application, reconfigure the Sample Sequencer priorities in the **ADCSSPRI** register. The default configuration has Sample Sequencer 0 with the highest priority, and Sample Sequencer 3 as the lowest priority.

### 12.3.2 Sample Sequencer Configuration

Configuration of the Sample Sequencers is slightly more complex than the module initialization since each sample sequence is completely programmable.

The configuration for each Sample Sequencer should be as follows:

1. Ensure that the Sample Sequencer is disabled by writing a 0 to the corresponding **ASEN** bit in the **ADCACTSS** register. Programming of the Sample Sequencers is allowed without having them enabled. Disabling the Sequencer during programming prevents erroneous execution if a trigger event were to occur during the configuration process.
2. Configure the trigger event for the Sample Sequencer in the **ADCEMUX** register.
3. For each sample in the sample sequence, configure the corresponding input source in the **ADCSSMUXn** register.

4. For each sample in the sample sequence, configure the sample control bits in the corresponding nibble in the **ADCSSCTLn** register. When programming the last nibble, ensure that the **END** bit is set. Failure to set the **END** bit causes unpredictable behavior.
5. If interrupts are to be used, write a 1 to the corresponding **MASK** bit in the **ADCIM** register.
6. Enable the Sample Sequencer logic by writing a 1 to the corresponding **ASEN** bit in the **ADCACTSS** register.

## 12.4 Register Map

Table 12-2 on page 262 lists the ADC registers. The offset listed is a hexadecimal increment to the register's address, relative to the ADC base address of 0x4003.8000.

**Table 12-2. ADC Register Map**

Offset	Name	Type	Reset	Description	See page
0x000	ADCACTSS	R/W	0x0000.0000	ADC Active Sample Sequencer	264
0x004	ADCRIS	RO	0x0000.0000	ADC Raw Interrupt Status	265
0x008	ADCIM	R/W	0x0000.0000	ADC Interrupt Mask	266
0x00C	ADCISC	R/W1C	0x0000.0000	ADC Interrupt Status and Clear	267
0x010	ADCOSTAT	R/W1C	0x0000.0000	ADC Overflow Status	268
0x014	ADCEMUX	R/W	0x0000.0000	ADC Event Multiplexer Select	269
0x018	ADCUSTAT	R/W1C	0x0000.0000	ADC Underflow Status	272
0x020	ADCSSPRI	R/W	0x0000.3210	ADC Sample Sequencer Priority	273
0x028	ADCPSSI	WO	-	ADC Processor Sample Sequence Initiate	274
0x030	ADCSAC	R/W	0x0000.0000	ADC Sample Averaging Control	275
0x040	ADCSSMUX0	R/W	0x0000.0000	ADC Sample Sequence Input Multiplexer Select 0	276
0x044	ADCSSCTL0	R/W	0x0000.0000	ADC Sample Sequence Control 0	278
0x048	ADCSSFIFO0	RO	0x0000.0000	ADC Sample Sequence Result FIFO 0	281
0x04C	ADCSSFSTAT0	RO	0x0000.0100	ADC Sample Sequence FIFO 0 Status	282
0x060	ADCSSMUX1	R/W	0x0000.0000	ADC Sample Sequence Input Multiplexer Select 1	283
0x064	ADCSSCTL1	R/W	0x0000.0000	ADC Sample Sequence Control 1	284
0x068	ADCSSFIFO1	RO	0x0000.0000	ADC Sample Sequence Result FIFO 1	281
0x06C	ADCSSFSTAT1	RO	0x0000.0100	ADC Sample Sequence FIFO 1 Status	282
0x080	ADCSSMUX2	R/W	0x0000.0000	ADC Sample Sequence Input Multiplexer Select 2	283
0x084	ADCSSCTL2	R/W	0x0000.0000	ADC Sample Sequence Control 2	284
0x088	ADCSSFIFO2	RO	0x0000.0000	ADC Sample Sequence Result FIFO 2	281
0x08C	ADCSSFSTAT2	RO	0x0000.0100	ADC Sample Sequence FIFO 2 Status	282
0x0A0	ADCSSMUX3	R/W	0x0000.0000	ADC Sample Sequence Input Multiplexer Select 3	286

---

Offset	Name	Type	Reset	Description	See page
0x0A4	ADCSSCTL3	R/W	0x0000.0002	ADC Sample Sequence Control 3	287
0x0A8	ADCSSFIFO3	RO	0x0000.0000	ADC Sample Sequence Result FIFO 3	281
0x0AC	ADCSSFSTAT3	RO	0x0000.0100	ADC Sample Sequence FIFO 3 Status	282
0x100	ADCTMLB	R/W	0x0000.0000	ADC Test Mode Loopback	288

## 12.5 Register Descriptions

The remainder of this section lists and describes the ADC registers, in numerical order by address offset.

### Register 1: ADC Active Sample Sequencer (ADCACTSS), offset 0x000

This register controls the activation of the Sample Sequencers. Each Sample Sequencer can be enabled/disabled independently.

#### ADC Active Sample Sequencer (ADCACTSS)

Base 0x4003.8000  
 Offset 0x000  
 Type R/W, reset 0x0000.0000

	31	30	29	28	27	26	25	24	23	22	21	20	19	18	17	16
	reserved															
Type	RO	RO	RO	RO	RO	RO	RO	RO	RO	RO	RO	RO	RO	RO	RO	RO
Reset	0	0	0	0	0	0	0	0	0	0	0	0	0	0	0	0
	15	14	13	12	11	10	9	8	7	6	5	4	3	2	1	0
	reserved												ASEN3	ASEN2	ASEN1	ASEN0
Type	RO	RO	RO	RO	RO	RO	RO	RO	RO	RO	RO	RO	R/W	R/W	R/W	R/W
Reset	0	0	0	0	0	0	0	0	0	0	0	0	0	0	0	0

Bit/Field	Name	Type	Reset	Description
31:4	reserved	RO	0x00	Software should not rely on the value of a reserved bit. To provide compatibility with future products, the value of a reserved bit should be preserved across a read-modify-write operation.
3	ASEN3	R/W	0	<p>ADC SS3 Enable</p> <p>Specifies whether Sample Sequencer 3 is enabled. If set, the sample sequence logic for Sequencer 3 is active. Otherwise, the Sequencer is inactive.</p>
2	ASEN2	R/W	0	<p>ADC SS2 Enable</p> <p>Specifies whether Sample Sequencer 2 is enabled. If set, the sample sequence logic for Sequencer 2 is active. Otherwise, the Sequencer is inactive.</p>
1	ASEN1	R/W	0	<p>ADC SS1 Enable</p> <p>Specifies whether Sample Sequencer 1 is enabled. If set, the sample sequence logic for Sequencer 1 is active. Otherwise, the Sequencer is inactive.</p>
0	ASEN0	R/W	0	<p>ADC SS0 Enable</p> <p>Specifies whether Sample Sequencer 0 is enabled. If set, the sample sequence logic for Sequencer 0 is active. Otherwise, the Sequencer is inactive.</p>



## Register 2: ADC Raw Interrupt Status (ADCRIS), offset 0x004

This register shows the status of the raw interrupt signal of each Sample Sequencer. These bits may be polled by software to look for interrupt conditions without having to generate controller interrupts.

### ADC Raw Interrupt Status (ADCRIS)

Base 0x4003.8000  
Offset 0x004  
Type RO, reset 0x0000.0000

	31	30	29	28	27	26	25	24	23	22	21	20	19	18	17	16
	reserved															
Type	RO	RO	RO	RO	RO	RO	RO	RO	RO	RO	RO	RO	RO	RO	RO	RO
Reset	0	0	0	0	0	0	0	0	0	0	0	0	0	0	0	0
	15	14	13	12	11	10	9	8	7	6	5	4	3	2	1	0
	reserved												INR3	INR2	INR1	INR0
Type	RO	RO	RO	RO	RO	RO	RO	RO	RO	RO	RO	RO	RO	RO	RO	RO
Reset	0	0	0	0	0	0	0	0	0	0	0	0	0	0	0	0

Bit/Field	Name	Type	Reset	Description
31:4	reserved	RO	0x00	Software should not rely on the value of a reserved bit. To provide compatibility with future products, the value of a reserved bit should be preserved across a read-modify-write operation.
3	INR3	RO	0	SS3 Raw Interrupt Status  Set by hardware when a sample with its respective <b>ADCSSCTL3</b> <small>IE</small> bit has completed conversion. This bit is cleared by writing a 1 to the <b>ADCISC</b> <small>IN3</small> bit.
2	INR2	RO	0	SS2 Raw Interrupt Status  Set by hardware when a sample with its respective <b>ADCSSCTL2</b> <small>IE</small> bit has completed conversion. This bit is cleared by writing a 1 to the <b>ADCISC</b> <small>IN2</small> bit.
1	INR1	RO	0	SS1 Raw Interrupt Status  Set by hardware when a sample with its respective <b>ADCSSCTL1</b> <small>IE</small> bit has completed conversion. This bit is cleared by writing a 1 to the <b>ADCISC</b> <small>IN1</small> bit.
0	INR0	RO	0	SS0 Raw Interrupt Status  Set by hardware when a sample with its respective <b>ADCSSCTL0</b> <small>IE</small> bit has completed conversion. This bit is cleared by writing a 1 to the <b>ADCISC</b> <small>IN0</small> bit.

### Register 3: ADC Interrupt Mask (ADCIM), offset 0x008

This register controls whether the Sample Sequencer raw interrupt signals are promoted to controller interrupts. The raw interrupt signal for each Sample Sequencer can be masked independently.

#### ADC Interrupt Mask (ADCIM)

Base 0x4003.8000  
 Offset 0x008  
 Type R/W, reset 0x0000.0000

	31	30	29	28	27	26	25	24	23	22	21	20	19	18	17	16
	reserved															
Type	RO	RO	RO	RO	RO	RO	RO	RO	RO	RO	RO	RO	RO	RO	RO	RO
Reset	0	0	0	0	0	0	0	0	0	0	0	0	0	0	0	0
	15	14	13	12	11	10	9	8	7	6	5	4	3	2	1	0
	reserved												MASK3	MASK2	MASK1	MASK0
Type	RO	RO	RO	RO	RO	RO	RO	RO	RO	RO	RO	RO	R/W	R/W	R/W	R/W
Reset	0	0	0	0	0	0	0	0	0	0	0	0	0	0	0	0

Bit/Field	Name	Type	Reset	Description
31:4	reserved	RO	0x00	Software should not rely on the value of a reserved bit. To provide compatibility with future products, the value of a reserved bit should be preserved across a read-modify-write operation.
3	MASK3	R/W	0	SS3 Interrupt Mask  Specifies whether the raw interrupt signal from Sample Sequencer 3 ( <b>ADCRIS</b> register <i>INR3</i> bit) is promoted to a controller interrupt. If set, the raw interrupt signal is promoted to a controller interrupt. Otherwise, it is not.
2	MASK2	R/W	0	SS2 Interrupt Mask  Specifies whether the raw interrupt signal from Sample Sequencer 2 ( <b>ADCRIS</b> register <i>INR2</i> bit) is promoted to a controller interrupt. If set, the raw interrupt signal is promoted to a controller interrupt. Otherwise, it is not.
1	MASK1	R/W	0	SS1 Interrupt Mask  Specifies whether the raw interrupt signal from Sample Sequencer 1 ( <b>ADCRIS</b> register <i>INR1</i> bit) is promoted to a controller interrupt. If set, the raw interrupt signal is promoted to a controller interrupt. Otherwise, it is not.
0	MASK0	R/W	0	SS0 Interrupt Mask  Specifies whether the raw interrupt signal from Sample Sequencer 0 ( <b>ADCRIS</b> register <i>INR0</i> bit) is promoted to a controller interrupt. If set, the raw interrupt signal is promoted to a controller interrupt. Otherwise, it is not.

## Register 4: ADC Interrupt Status and Clear (ADCISC), offset 0x00C

This register provides the mechanism for clearing interrupt conditions, and shows the status of controller interrupts generated by the Sample Sequencers. When read, each bit field is the logical AND of the respective `INR` and `MASK` bits. Interrupts are cleared by writing a 1 to the corresponding bit position. If software is polling the `ADCRIS` instead of generating interrupts, the `INR` bits are still cleared via the `ADCISC` register, even if the `IN` bit is not set.

### ADC Interrupt Status and Clear (ADCISC)

Base 0x4003.8000

Offset 0x00C

Type R/W1C, reset 0x0000.0000

	31	30	29	28	27	26	25	24	23	22	21	20	19	18	17	16	
	reserved																
Type	RO	RO	RO	RO	RO	RO	RO	RO	RO	RO	RO	RO	RO	RO	RO	RO	
Reset	0	0	0	0	0	0	0	0	0	0	0	0	0	0	0	0	
	15	14	13	12	11	10	9	8	7	6	5	4	3	2	1	0	
	reserved												IN3	IN2	IN1	IN0	
Type	RO	RO	RO	RO	RO	RO	RO	RO	RO	RO	RO	RO	RO	R/W1C	R/W1C	R/W1C	R/W1C
Reset	0	0	0	0	0	0	0	0	0	0	0	0	0	0	0	0	0

Bit/Field	Name	Type	Reset	Description
31:4	reserved	RO	0x00	Software should not rely on the value of a reserved bit. To provide compatibility with future products, the value of a reserved bit should be preserved across a read-modify-write operation.
3	IN3	R/W1C	0	SS3 Interrupt Status and Clear  This bit is set by hardware when the <code>MASK3</code> and <code>INR3</code> bits are both 1, providing a level-based interrupt to the controller. It is cleared by writing a 1, and also clears the <code>INR3</code> bit.
2	IN2	R/W1C	0	SS2 Interrupt Status and Clear  This bit is set by hardware when the <code>MASK2</code> and <code>INR2</code> bits are both 1, providing a level based interrupt to the controller. It is cleared by writing a 1, and also clears the <code>INR2</code> bit.
1	IN1	R/W1C	0	SS1 Interrupt Status and Clear  This bit is set by hardware when the <code>MASK1</code> and <code>INR1</code> bits are both 1, providing a level based interrupt to the controller. It is cleared by writing a 1, and also clears the <code>INR1</code> bit.
0	IN0	R/W1C	0	SS0 Interrupt Status and Clear  This bit is set by hardware when the <code>MASK0</code> and <code>INR0</code> bits are both 1, providing a level based interrupt to the controller. It is cleared by writing a 1, and also clears the <code>INR0</code> bit.

### Register 5: ADC Overflow Status (ADCOSTAT), offset 0x010

This register indicates overflow conditions in the Sample Sequencer FIFOs. Once the overflow condition has been handled by software, the condition can be cleared by writing a 1 to the corresponding bit position.

#### ADC Overflow Status (ADCOSTAT)

Base 0x4003.8000  
 Offset 0x010  
 Type R/W1C, reset 0x0000.0000

	31	30	29	28	27	26	25	24	23	22	21	20	19	18	17	16
	reserved															
Type	RO	RO	RO	RO	RO	RO	RO	RO	RO	RO	RO	RO	RO	RO	RO	RO
Reset	0	0	0	0	0	0	0	0	0	0	0	0	0	0	0	0
	15	14	13	12	11	10	9	8	7	6	5	4	3	2	1	0
	reserved												OV3	OV2	OV1	OV0
Type	RO	RO	RO	RO	RO	RO	RO	RO	RO	RO	RO	RO	R/W1C	R/W1C	R/W1C	R/W1C
Reset	0	0	0	0	0	0	0	0	0	0	0	0	0	0	0	0

Bit/Field	Name	Type	Reset	Description
31:4	reserved	RO	0x00	Software should not rely on the value of a reserved bit. To provide compatibility with future products, the value of a reserved bit should be preserved across a read-modify-write operation.
3	OV3	R/W1C	0	SS3 FIFO Overflow  This bit specifies that the FIFO for Sample Sequencer 3 has hit an overflow condition where the FIFO is full and a write was requested. When an overflow is detected, the most recent write is dropped and this bit is set by hardware to indicate the occurrence of dropped data. This bit is cleared by writing a 1.
2	OV2	R/W1C	0	SS2 FIFO Overflow  This bit specifies that the FIFO for Sample Sequencer 2 has hit an overflow condition where the FIFO is full and a write was requested. When an overflow is detected, the most recent write is dropped and this bit is set by hardware to indicate the occurrence of dropped data. This bit is cleared by writing a 1.
1	OV1	R/W1C	0	SS1 FIFO Overflow  This bit specifies that the FIFO for Sample Sequencer 1 has hit an overflow condition where the FIFO is full and a write was requested. When an overflow is detected, the most recent write is dropped and this bit is set by hardware to indicate the occurrence of dropped data. This bit is cleared by writing a 1.
0	OV0	R/W1C	0	SS0 FIFO Overflow  This bit specifies that the FIFO for Sample Sequencer 0 has hit an overflow condition where the FIFO is full and a write was requested. When an overflow is detected, the most recent write is dropped and this bit is set by hardware to indicate the occurrence of dropped data. This bit is cleared by writing a 1.

## Register 6: ADC Event Multiplexer Select (ADCEMUX), offset 0x014

The **ADCEMUX** selects the event (trigger) that initiates sampling for each Sample Sequencer. Each Sample Sequencer can be configured with a unique trigger source.

### ADC Event Multiplexer Select (ADCEMUX)

Base 0x4003.8000

Offset 0x014

Type R/W, reset 0x0000.0000

	31	30	29	28	27	26	25	24	23	22	21	20	19	18	17	16
	reserved															
Type	RO	RO	RO	RO	RO	RO	RO	RO	RO	RO	RO	RO	RO	RO	RO	RO
Reset	0	0	0	0	0	0	0	0	0	0	0	0	0	0	0	0
	15	14	13	12	11	10	9	8	7	6	5	4	3	2	1	0
	EM3				EM2				EM1				EM0			
Type	R/W	R/W	R/W	R/W	R/W	R/W	R/W	R/W	R/W	R/W	R/W	R/W	R/W	R/W	R/W	R/W
Reset	0	0	0	0	0	0	0	0	0	0	0	0	0	0	0	0

Bit/Field	Name	Type	Reset	Description
31:16	reserved	RO	0x00	Software should not rely on the value of a reserved bit. To provide compatibility with future products, the value of a reserved bit should be preserved across a read-modify-write operation.

15:12	EM3	R/W	0x00	SS3 Trigger Select This field selects the trigger source for Sample Sequencer 3.
-------	-----	-----	------	---

The valid configurations for this field are:

Value	Event
0x0	Controller (default)
0x1	Analog Comparator 0
0x2	Analog Comparator 1
0x3	Analog Comparator 2
0x4	External (GPIO PB4)
0x5	Timer
0x6	Reserved
0x7	Reserved
0x8	Reserved
0x9-0xE	reserved
0xF	Always (continuously sample)

Bit/Field	Name	Type	Reset	Description																								
11:8	EM2	R/W	0x00	<p>SS2 Trigger Select</p> <p>This field selects the trigger source for Sample Sequencer 2.</p> <p>The valid configurations for this field are:</p> <table border="1"><thead><tr><th>Value</th><th>Event</th></tr></thead><tbody><tr><td>0x0</td><td>Controller (default)</td></tr><tr><td>0x1</td><td>Analog Comparator 0</td></tr><tr><td>0x2</td><td>Analog Comparator 1</td></tr><tr><td>0x3</td><td>Analog Comparator 2</td></tr><tr><td>0x4</td><td>External (GPIO PB4)</td></tr><tr><td>0x5</td><td>Timer</td></tr><tr><td>0x6</td><td>Reserved</td></tr><tr><td>0x7</td><td>Reserved</td></tr><tr><td>0x8</td><td>Reserved</td></tr><tr><td>0x9-0xE</td><td>reserved</td></tr><tr><td>0xF</td><td>Always (continuously sample)</td></tr></tbody></table>	Value	Event	0x0	Controller (default)	0x1	Analog Comparator 0	0x2	Analog Comparator 1	0x3	Analog Comparator 2	0x4	External (GPIO PB4)	0x5	Timer	0x6	Reserved	0x7	Reserved	0x8	Reserved	0x9-0xE	reserved	0xF	Always (continuously sample)
Value	Event																											
0x0	Controller (default)																											
0x1	Analog Comparator 0																											
0x2	Analog Comparator 1																											
0x3	Analog Comparator 2																											
0x4	External (GPIO PB4)																											
0x5	Timer																											
0x6	Reserved																											
0x7	Reserved																											
0x8	Reserved																											
0x9-0xE	reserved																											
0xF	Always (continuously sample)																											
7:4	EM1	R/W	0x00	<p>SS1 Trigger Select</p> <p>This field selects the trigger source for Sample Sequencer 1.</p> <p>The valid configurations for this field are:</p> <table border="1"><thead><tr><th>Value</th><th>Event</th></tr></thead><tbody><tr><td>0x0</td><td>Controller (default)</td></tr><tr><td>0x1</td><td>Analog Comparator 0</td></tr><tr><td>0x2</td><td>Analog Comparator 1</td></tr><tr><td>0x3</td><td>Analog Comparator 2</td></tr><tr><td>0x4</td><td>External (GPIO PB4)</td></tr><tr><td>0x5</td><td>Timer</td></tr><tr><td>0x6</td><td>Reserved</td></tr><tr><td>0x7</td><td>Reserved</td></tr><tr><td>0x8</td><td>Reserved</td></tr><tr><td>0x9-0xE</td><td>reserved</td></tr><tr><td>0xF</td><td>Always (continuously sample)</td></tr></tbody></table>	Value	Event	0x0	Controller (default)	0x1	Analog Comparator 0	0x2	Analog Comparator 1	0x3	Analog Comparator 2	0x4	External (GPIO PB4)	0x5	Timer	0x6	Reserved	0x7	Reserved	0x8	Reserved	0x9-0xE	reserved	0xF	Always (continuously sample)
Value	Event																											
0x0	Controller (default)																											
0x1	Analog Comparator 0																											
0x2	Analog Comparator 1																											
0x3	Analog Comparator 2																											
0x4	External (GPIO PB4)																											
0x5	Timer																											
0x6	Reserved																											
0x7	Reserved																											
0x8	Reserved																											
0x9-0xE	reserved																											
0xF	Always (continuously sample)																											

---

Bit/Field	Name	Type	Reset	Description																								
3:0	EM0	R/W	0x00	<p>SS0 Trigger Select</p> <p>This field selects the trigger source for Sample Sequencer 0.</p> <p>The valid configurations for this field are:</p> <table><thead><tr><th>Value</th><th>Event</th></tr></thead><tbody><tr><td>0x0</td><td>Controller (default)</td></tr><tr><td>0x1</td><td>Analog Comparator 0</td></tr><tr><td>0x2</td><td>Analog Comparator 1</td></tr><tr><td>0x3</td><td>Analog Comparator 2</td></tr><tr><td>0x4</td><td>External (GPIO PB4)</td></tr><tr><td>0x5</td><td>Timer</td></tr><tr><td>0x6</td><td>Reserved</td></tr><tr><td>0x7</td><td>Reserved</td></tr><tr><td>0x8</td><td>Reserved</td></tr><tr><td>0x9-0xE</td><td>reserved</td></tr><tr><td>0xF</td><td>Always (continuously sample)</td></tr></tbody></table>	Value	Event	0x0	Controller (default)	0x1	Analog Comparator 0	0x2	Analog Comparator 1	0x3	Analog Comparator 2	0x4	External (GPIO PB4)	0x5	Timer	0x6	Reserved	0x7	Reserved	0x8	Reserved	0x9-0xE	reserved	0xF	Always (continuously sample)
Value	Event																											
0x0	Controller (default)																											
0x1	Analog Comparator 0																											
0x2	Analog Comparator 1																											
0x3	Analog Comparator 2																											
0x4	External (GPIO PB4)																											
0x5	Timer																											
0x6	Reserved																											
0x7	Reserved																											
0x8	Reserved																											
0x9-0xE	reserved																											
0xF	Always (continuously sample)																											

### Register 7: ADC Underflow Status (ADCUSTAT), offset 0x018

This register indicates underflow conditions in the Sample Sequencer FIFOs. The corresponding underflow condition can be cleared by writing a 1 to the relevant bit position.

#### ADC Underflow Status (ADCUSTAT)

Base 0x4003.8000  
 Offset 0x018  
 Type R/W1C, reset 0x0000.0000

	31	30	29	28	27	26	25	24	23	22	21	20	19	18	17	16
	reserved															
Type	RO	RO	RO	RO	RO	RO	RO	RO	RO	RO	RO	RO	RO	RO	RO	RO
Reset	0	0	0	0	0	0	0	0	0	0	0	0	0	0	0	0
	15	14	13	12	11	10	9	8	7	6	5	4	3	2	1	0
	reserved												UV3	UV2	UV1	UV0
Type	RO	RO	RO	RO	RO	RO	RO	RO	RO	RO	RO	RO	R/W1C	R/W1C	R/W1C	R/W1C
Reset	0	0	0	0	0	0	0	0	0	0	0	0	0	0	0	0

Bit/Field	Name	Type	Reset	Description
31:4	reserved	RO	0x00	Software should not rely on the value of a reserved bit. To provide compatibility with future products, the value of a reserved bit should be preserved across a read-modify-write operation.
3	UV3	R/W1C	0	SS3 FIFO Underflow  This bit specifies that the FIFO for Sample Sequencer 3 has hit an underflow condition where the FIFO is empty and a read was requested. The problematic read does not move the FIFO pointers, and 0s are returned. This bit is cleared by writing a 1.
2	UV2	R/W1C	0	SS2 FIFO Underflow  This bit specifies that the FIFO for Sample Sequencer 2 has hit an underflow condition where the FIFO is empty and a read was requested. The problematic read does not move the FIFO pointers, and 0s are returned. This bit is cleared by writing a 1.
1	UV1	R/W1C	0	SS1 FIFO Underflow  This bit specifies that the FIFO for Sample Sequencer 1 has hit an underflow condition where the FIFO is empty and a read was requested. The problematic read does not move the FIFO pointers, and 0s are returned. This bit is cleared by writing a 1.
0	UV0	R/W1C	0	SS0 FIFO Underflow  This bit specifies that the FIFO for Sample Sequencer 0 has hit an underflow condition where the FIFO is empty and a read was requested. The problematic read does not move the FIFO pointers, and 0s are returned. This bit is cleared by writing a 1.



## Register 8: ADC Sample Sequencer Priority (ADCSSPRI), offset 0x020

This register sets the priority for each of the Sample Sequencers. Out of reset, Sequencer 0 has the highest priority, and sample sequence 3 has the lowest priority. When reconfiguring sequence priorities, each sequence must have a unique priority or the ADC behavior is inconsistent.

### ADC Sample Sequencer Priority (ADCSSPRI)

Base 0x4003.8000  
Offset 0x020  
Type R/W, reset 0x0000.3210

	31	30	29	28	27	26	25	24	23	22	21	20	19	18	17	16
	reserved															
Type	RO	RO	RO	RO	RO	RO	RO	RO	RO	RO	RO	RO	RO	RO	RO	RO
Reset	0	0	0	0	0	0	0	0	0	0	0	0	0	0	0	0
	15	14	13	12	11	10	9	8	7	6	5	4	3	2	1	0
	reserved		SS3		reserved		SS2		reserved		SS1		reserved		SS0	
Type	RO	RO	R/W	R/W	RO	RO	R/W	R/W	RO	RO	R/W	R/W	RO	RO	R/W	R/W
Reset	0	0	1	1	0	0	1	0	0	0	0	1	0	0	0	0

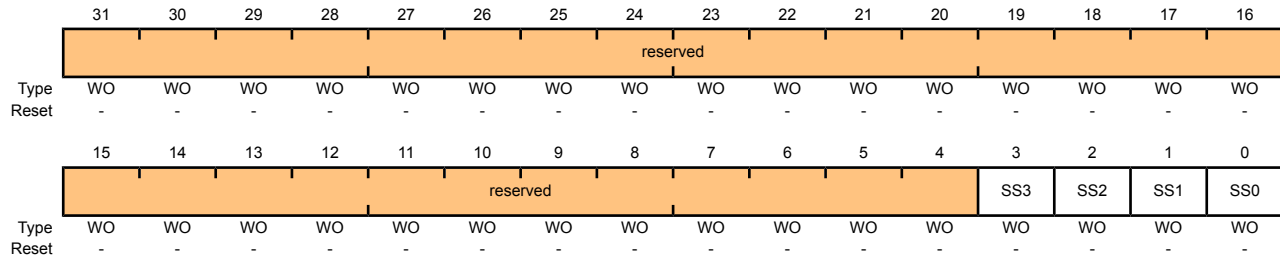
Bit/Field	Name	Type	Reset	Description
31:14	reserved	RO	0x00	Software should not rely on the value of a reserved bit. To provide compatibility with future products, the value of a reserved bit should be preserved across a read-modify-write operation.
13:12	SS3	R/W	0x3	SS3 Priority  The SS3 field contains a binary-encoded value that specifies the priority encoding of Sample Sequencer 3. A priority encoding of 0 is highest and 3 is lowest. The priorities assigned to the Sequencers must be uniquely mapped. ADC behavior is not consistent if two or more fields are equal.
11:10	reserved	RO	0x0	Software should not rely on the value of a reserved bit. To provide compatibility with future products, the value of a reserved bit should be preserved across a read-modify-write operation.
9:8	SS2	R/W	0x2	SS2 Priority  The SS2 field contains a binary-encoded value that specifies the priority encoding of Sample Sequencer 2.
7:6	reserved	RO	0x0	Software should not rely on the value of a reserved bit. To provide compatibility with future products, the value of a reserved bit should be preserved across a read-modify-write operation.
5:4	SS1	R/W	0x1	SS1 Priority  The SS1 field contains a binary-encoded value that specifies the priority encoding of Sample Sequencer 1.
3:2	reserved	RO	0x0	Software should not rely on the value of a reserved bit. To provide compatibility with future products, the value of a reserved bit should be preserved across a read-modify-write operation.
1:0	SS0	R/W	0x0	SS0 Priority  The SS0 field contains a binary-encoded value that specifies the priority encoding of Sample Sequencer 0.

### Register 9: ADC Processor Sample Sequence Initiate (ADCPSSI), offset 0x028

This register provides a mechanism for application software to initiate sampling in the Sample Sequencers. Sample sequences can be initiated individually or in any combination. When multiple sequences are triggered simultaneously, the priority encodings in **ADCSSPRI** dictate execution order.

#### ADC Processor Sample Sequence Initiate (ADCPSSI)

Base 0x4003.8000  
 Offset 0x028  
 Type WO, reset -



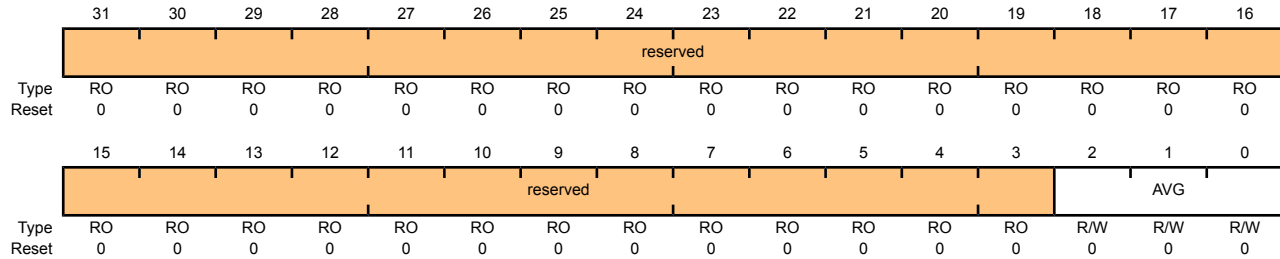
Bit/Field	Name	Type	Reset	Description
31:4	reserved	WO	-	Software should not rely on the value of a reserved bit. To provide compatibility with future products, the value of a reserved bit should be preserved across a read-modify-write operation.
3	SS3	WO	-	SS3 Initiate  Only a write by software is valid; a read of the register returns no meaningful data. When set by software, sampling is triggered on Sample Sequencer 3, assuming the Sequencer is enabled in the <b>ADCACTSS</b> register.
2	SS2	WO	-	SS2 Initiate  Only a write by software is valid; a read of the register returns no meaningful data. When set by software, sampling is triggered on Sample Sequencer 2, assuming the Sequencer is enabled in the <b>ADCACTSS</b> register.
1	SS1	WO	-	SS1 Initiate  Only a write by software is valid; a read of the register returns no meaningful data. When set by software, sampling is triggered on Sample Sequencer 1, assuming the Sequencer is enabled in the <b>ADCACTSS</b> register.
0	SS0	WO	-	SS0 Initiate  Only a write by software is valid; a read of the register returns no meaningful data. When set by software, sampling is triggered on Sample Sequencer 0, assuming the Sequencer is enabled in the <b>ADCACTSS</b> register.

### Register 10: ADC Sample Averaging Control (ADCSAC), offset 0x030

This register controls the amount of hardware averaging applied to conversion results. The final conversion result stored in the FIFO is averaged from  $2^{AVG}$  consecutive ADC samples at the specified ADC speed. If AVG is 0, the sample is passed directly through without any averaging. If AVG=6, then 64 consecutive ADC samples are averaged to generate one result in the sequencer FIFO. An AVG = 7 provides unpredictable results.

#### ADC Sample Averaging Control (ADCSAC)

Base 0x4003.8000  
 Offset 0x030  
 Type R/W, reset 0x0000.0000



Bit/Field	Name	Type	Reset	Description
31:3	reserved	RO	0x00	Software should not rely on the value of a reserved bit. To provide compatibility with future products, the value of a reserved bit should be preserved across a read-modify-write operation.
2:0	AVG	R/W	0x0	Hardware Averaging Control  Specifies the amount of hardware averaging that will be applied to ADC samples. The AVG field can be any value between 0 and 6. Entering a value of 7 creates unpredictable results.
				Value Description
			0x0	No hardware oversampling
			0x1	2x hardware oversampling
			0x2	4x hardware oversampling
			0x3	8x hardware oversampling
			0x4	16x hardware oversampling
			0x5	32x hardware oversampling
			0x6	64x hardware oversampling
			0x7	Reserved

### Register 11: ADC Sample Sequence Input Multiplexer Select 0 (ADCSSMUX0), offset 0x040

This register defines the analog input configuration for each sample in a sequence executed with Sample Sequencer 0.

This register is 32-bits wide and contains information for eight possible samples.

#### ADC Sample Sequence Input Multiplexer Select 0 (ADCSSMUX0)

Base 0x4003.8000  
 Offset 0x040  
 Type R/W, reset 0x0000.0000

	31	30	29	28	27	26	25	24	23	22	21	20	19	18	17	16
	reserved	MUX7			reserved	MUX6			reserved	MUX5			reserved	MUX4		
Type	RO	R/W	R/W	R/W	RO	R/W	R/W	R/W	RO	R/W	R/W	R/W	RO	R/W	R/W	R/W
Reset	0	0	0	0	0	0	0	0	0	0	0	0	0	0	0	0
	15	14	13	12	11	10	9	8	7	6	5	4	3	2	1	0
	reserved	MUX3			reserved	MUX2			reserved	MUX1			reserved	MUX0		
Type	RO	R/W	R/W	R/W	RO	R/W	R/W	R/W	RO	R/W	R/W	R/W	RO	R/W	R/W	R/W
Reset	0	0	0	0	0	0	0	0	0	0	0	0	0	0	0	0

Bit/Field	Name	Type	Reset	Description
31	reserved	RO	0	Software should not rely on the value of a reserved bit. To provide compatibility with future products, the value of a reserved bit should be preserved across a read-modify-write operation.
30:28	MUX7	R/W	0	8th Sample Input Select  The MUX7 field is used during the eighth sample of a sequence executed with the Sample Sequencer. It specifies which of the analog inputs is sampled for the analog-to-digital conversion. The value set here indicates the corresponding pin, for example, a value of 1 indicates the input is ADC1.
27	reserved	RO	0	Software should not rely on the value of a reserved bit. To provide compatibility with future products, the value of a reserved bit should be preserved across a read-modify-write operation.
26:24	MUX6	R/W	0	7th Sample Input Select  The MUX6 field is used during the seventh sample of a sequence executed with the Sample Sequencer and specifies which of the analog inputs is sampled for the analog-to-digital conversion.
23	reserved	RO	0	Software should not rely on the value of a reserved bit. To provide compatibility with future products, the value of a reserved bit should be preserved across a read-modify-write operation.
22:20	MUX5	R/W	0	6th Sample Input Select  The MUX5 field is used during the sixth sample of a sequence executed with the Sample Sequencer and specifies which of the analog inputs is sampled for the analog-to-digital conversion.
19	reserved	RO	0	Software should not rely on the value of a reserved bit. To provide compatibility with future products, the value of a reserved bit should be preserved across a read-modify-write operation.

Bit/Field	Name	Type	Reset	Description
18:16	MUX4	R/W	0	<p>5th Sample Input Select</p> <p>The MUX4 field is used during the fifth sample of a sequence executed with the Sample Sequencer and specifies which of the analog inputs is sampled for the analog-to-digital conversion.</p>
15	reserved	RO	0	Software should not rely on the value of a reserved bit. To provide compatibility with future products, the value of a reserved bit should be preserved across a read-modify-write operation.
14:12	MUX3	R/W	0	<p>4th Sample Input Select</p> <p>The MUX3 field is used during the fourth sample of a sequence executed with the Sample Sequencer and specifies which of the analog inputs is sampled for the analog-to-digital conversion.</p>
11	reserved	RO	0	Software should not rely on the value of a reserved bit. To provide compatibility with future products, the value of a reserved bit should be preserved across a read-modify-write operation.
10:8	MUX2	R/W	0	<p>3rd Sample Input Select</p> <p>The MUX2 field is used during the third sample of a sequence executed with the Sample Sequencer and specifies which of the analog inputs is sampled for the analog-to-digital conversion.</p>
7	reserved	RO	0	Software should not rely on the value of a reserved bit. To provide compatibility with future products, the value of a reserved bit should be preserved across a read-modify-write operation.
6:4	MUX1	R/W	0	<p>2nd Sample Input Select</p> <p>The MUX1 field is used during the second sample of a sequence executed with the Sample Sequencer and specifies which of the analog inputs is sampled for the analog-to-digital conversion.</p>
3	reserved	RO	0	Software should not rely on the value of a reserved bit. To provide compatibility with future products, the value of a reserved bit should be preserved across a read-modify-write operation.
2:0	MUX0	R/W	0	<p>1st Sample Input Select</p> <p>The MUX0 field is used during the first sample of a sequence executed with the Sample Sequencer and specifies which of the analog inputs is sampled for the analog-to-digital conversion.</p>

### Register 12: ADC Sample Sequence Control 0 (ADCSSCTL0), offset 0x044

This register contains the configuration information for each sample for a sequence executed with Sample Sequencer 0. When configuring a sample sequence, the `END` bit must be set at some point, whether it be after the first sample, last sample, or any sample in between.

This register is 32-bits wide and contains information for eight possible samples.

#### ADC Sample Sequence Control 0 (ADCSSCTL0)

Base 0x4003.8000  
 Offset 0x044  
 Type R/W, reset 0x0000.0000

	31	30	29	28	27	26	25	24	23	22	21	20	19	18	17	16
	TS7	IE7	END7	D7	TS6	IE6	END6	D6	TS5	IE5	END5	D5	TS4	IE4	END4	D4
Type	R/W	R/W	R/W	R/W	R/W	R/W	R/W	R/W	R/W	R/W	R/W	R/W	R/W	R/W	R/W	R/W
Reset	0	0	0	0	0	0	0	0	0	0	0	0	0	0	0	0
	15	14	13	12	11	10	9	8	7	6	5	4	3	2	1	0
	TS3	IE3	END3	D3	TS2	IE2	END2	D2	TS1	IE1	END1	D1	TS0	IE0	END0	D0
Type	R/W	R/W	R/W	R/W	R/W	R/W	R/W	R/W	R/W	R/W	R/W	R/W	R/W	R/W	R/W	R/W
Reset	0	0	0	0	0	0	0	0	0	0	0	0	0	0	0	0

Bit/Field	Name	Type	Reset	Description
31	TS7	R/W	0	<p>8th Sample Temp Sensor Select</p> <p>The <code>TS7</code> bit is used during the eighth sample of the sample sequence and specifies the input source of the sample. If set, the temperature sensor is read. Otherwise, the input pin specified by the <code>ADCSSMUX</code> register is read.</p>
30	IE7	R/W	0	<p>8th Sample Interrupt Enable</p> <p>The <code>IE7</code> bit is used during the eighth sample of the sample sequence and specifies whether the raw interrupt signal (<code>INR0</code> bit) is asserted at the end of the sample's conversion. If the <code>MASK0</code> bit in the <code>ADCIM</code> register is set, the interrupt is promoted to a controller-level interrupt. When this bit is set, the raw interrupt is asserted, otherwise it is not. It is legal to have multiple samples within a sequence generate interrupts.</p>
29	END7	R/W	0	<p>8th Sample is End of Sequence</p> <p>The <code>END7</code> bit indicates that this is the last sample of the sequence. It is possible to end the sequence on any sample position. Samples defined after the sample containing a set <code>END</code> are not requested for conversion even though the fields may be non-zero. It is required that software write the <code>END</code> bit somewhere within the sequence. (Sample Sequencer 3, which only has a single sample in the sequence, is hardwired to have the <code>END0</code> bit set.)</p> <p>Setting this bit indicates that this sample is the last in the sequence.</p>
28	D7	R/W	0	<p>8th Sample Diff Input Select</p> <p>The <code>D7</code> bit indicates that the analog input is to be differentially sampled. The corresponding <code>ADCSSMUXx</code> nibble must be set to the pair number "<code>i</code>", where the paired inputs are "<code>2i</code> and <code>2i+1</code>". The temperature sensor does not have a differential option. When set, the analog inputs are differentially sampled.</p>
27	TS6	R/W	0	<p>7th Sample Temp Sensor Select</p> <p>Same definition as <code>TS7</code> but used during the seventh sample.</p>

Bit/Field	Name	Type	Reset	Description
26	IE6	R/W	0	7th Sample Interrupt Enable Same definition as IE7 but used during the seventh sample.
25	END6	R/W	0	7th Sample is End of Sequence Same definition as END7 but used during the seventh sample.
24	D6	R/W	0	7th Sample Diff Input Select Same definition as D7 but used during the seventh sample.
23	TS5	R/W	0	6th Sample Temp Sensor Select Same definition as TS7 but used during the sixth sample.
22	IE5	R/W	0	6th Sample Interrupt Enable Same definition as IE7 but used during the sixth sample.
21	END5	R/W	0	6th Sample is End of Sequence Same definition as END7 but used during the sixth sample.
20	D5	R/W	0	6th Sample Diff Input Select Same definition as D7 but used during the sixth sample.
19	TS4	R/W	0	5th Sample Temp Sensor Select Same definition as TS7 but used during the fifth sample.
18	IE4	R/W	0	5th Sample Interrupt Enable Same definition as IE7 but used during the fifth sample.
17	END4	R/W	0	5th Sample is End of Sequence Same definition as END7 but used during the fifth sample.
16	D4	R/W	0	5th Sample Diff Input Select Same definition as D7 but used during the fifth sample.
15	TS3	R/W	0	4th Sample Temp Sensor Select Same definition as TS7 but used during the fourth sample.
14	IE3	R/W	0	4th Sample Interrupt Enable Same definition as IE7 but used during the fourth sample.
13	END3	R/W	0	4th Sample is End of Sequence Same definition as END7 but used during the fourth sample.
12	D3	R/W	0	4th Sample Diff Input Select Same definition as D7 but used during the fourth sample.
11	TS2	R/W	0	3rd Sample Temp Sensor Select Same definition as TS7 but used during the third sample.

Bit/Field	Name	Type	Reset	Description
10	IE2	R/W	0	3rd Sample Interrupt Enable Same definition as IE7 but used during the third sample.
9	END2	R/W	0	3rd Sample is End of Sequence Same definition as END7 but used during the third sample.
8	D2	R/W	0	3rd Sample Diff Input Select Same definition as D7 but used during the third sample.
7	TS1	R/W	0	2nd Sample Temp Sensor Select Same definition as TS7 but used during the second sample.
6	IE1	R/W	0	2nd Sample Interrupt Enable Same definition as IE7 but used during the second sample.
5	END1	R/W	0	2nd Sample is End of Sequence Same definition as END7 but used during the second sample.
4	D1	R/W	0	2nd Sample Diff Input Select Same definition as D7 but used during the second sample.
3	TS0	R/W	0	1st Sample Temp Sensor Select Same definition as TS7 but used during the first sample.
2	IE0	R/W	0	1st Sample Interrupt Enable Same definition as IE7 but used during the first sample.
1	END0	R/W	0	1st Sample is End of Sequence Same definition as END7 but used during the first sample. Since this sequencer has only one entry, this bit must be set.
0	D0	R/W	0	1st Sample Diff Input Select Same definition as D7 but used during the first sample.



**Register 13: ADC Sample Sequence Result FIFO 0 (ADCSSFIFO0), offset 0x048**

**Register 14: ADC Sample Sequence Result FIFO 1 (ADCSSFIFO1), offset 0x068**

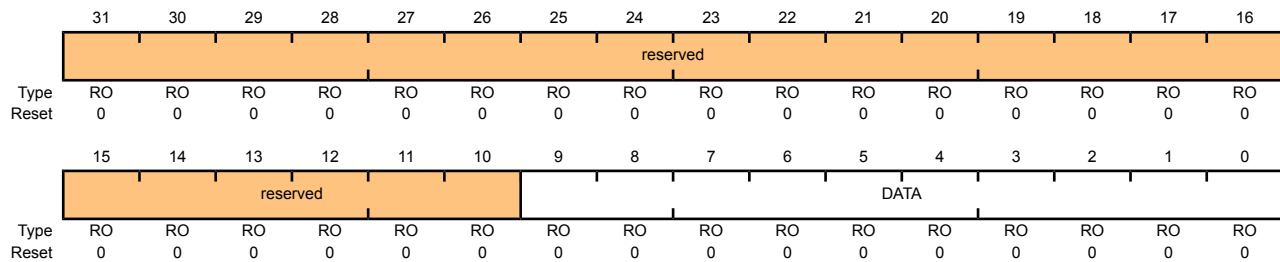
**Register 15: ADC Sample Sequence Result FIFO 2 (ADCSSFIFO2), offset 0x088**

**Register 16: ADC Sample Sequence Result FIFO 3 (ADCSSFIFO3), offset 0x0A8**

This register contains the conversion results for samples collected with the Sample Sequencer (the **ADCSSFIFO0** register is used for Sample Sequencer 0, **ADCSSFIFO1** for Sequencer 1, **ADCSSFIFO2** for Sequencer 2, and **ADCSSFIFO3** for Sequencer 3). Reads of this register return conversion result data in the order sample 0, sample 1, and so on, until the FIFO is empty. If the FIFO is not properly handled by software, overflow and underflow conditions are registered in the **ADCOSTAT** and **ADCUSTAT** registers.

ADC Sample Sequence Result FIFO 0 (ADCSSFIFO0)

Base 0x4003.8000  
 Offset 0x048  
 Type RO, reset 0x0000.0000



Bit/Field	Name	Type	Reset	Description
31:10	reserved	RO	0x00	Software should not rely on the value of a reserved bit. To provide compatibility with future products, the value of a reserved bit should be preserved across a read-modify-write operation.
9:0	DATA	RO	0x00	Conversion Result Data

**Register 17: ADC Sample Sequence FIFO 0 Status (ADCSSFSTAT0), offset 0x04C**

**Register 18: ADC Sample Sequence FIFO 1 Status (ADCSSFSTAT1), offset 0x06C**

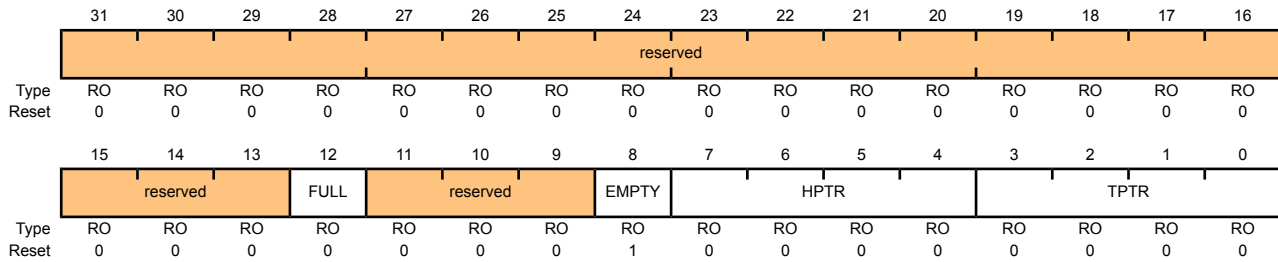
**Register 19: ADC Sample Sequence FIFO 2 Status (ADCSSFSTAT2), offset 0x08C**

**Register 20: ADC Sample Sequence FIFO 3 Status (ADCSSFSTAT3), offset 0x0AC**

This register provides a window into the Sample Sequencer, providing full/empty status information as well as the positions of the head and tail pointers. The reset value of 0x100 indicates an empty FIFO. The **ADCSSFSTAT0** register provides status on FIFO0, **ADCSSFSTAT1** on FIFO1, **ADCSSFSTAT2** on FIFO2, and **ADCSSFSTAT3** on FIFO3.

ADC Sample Sequence FIFO 0 Status (ADCSSFSTAT0)

Base 0x4003.8000  
 Offset 0x04C  
 Type RO, reset 0x0000.0100



Bit/Field	Name	Type	Reset	Description
31:13	reserved	RO	0x00	Software should not rely on the value of a reserved bit. To provide compatibility with future products, the value of a reserved bit should be preserved across a read-modify-write operation.
12	FULL	RO	0	FIFO Full When set, indicates that the FIFO is currently full.
11:9	reserved	RO	0x00	Software should not rely on the value of a reserved bit. To provide compatibility with future products, the value of a reserved bit should be preserved across a read-modify-write operation.
8	EMPTY	RO	1	FIFO Empty When set, indicates that the FIFO is currently empty.
7:4	HPTR	RO	0x00	FIFO Head Pointer This field contains the current "head" pointer index for the FIFO, that is, the next entry to be written.
3:0	TPTR	RO	0x00	FIFO Tail Pointer This field contains the current "tail" pointer index for the FIFO, that is, the next entry to be read.

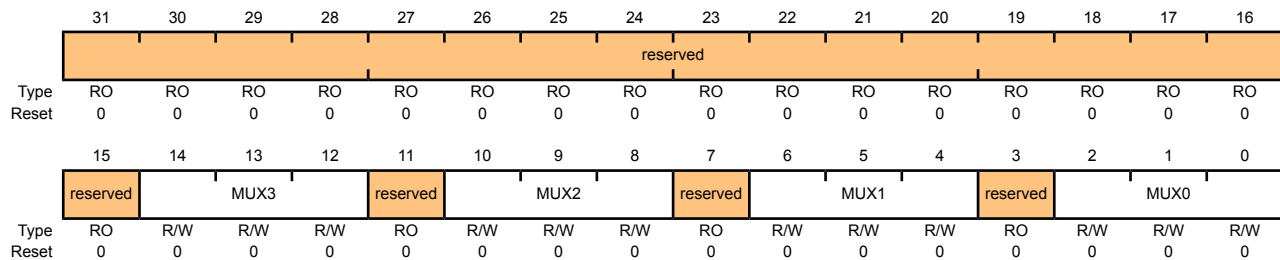
**Register 21: ADC Sample Sequence Input Multiplexer Select 1 (ADCSSMUX1), offset 0x060**

**Register 22: ADC Sample Sequence Input Multiplexer Select 2 (ADCSSMUX2), offset 0x080**

This register defines the analog input configuration for each sample in a sequence executed with Sample Sequencer 1 or 2. These registers are 16-bits wide and contain information for four possible samples. See the **ADCSSMUX0** register on page 276 for detailed bit descriptions.

ADC Sample Sequence Input Multiplexer Select 1 (ADCSSMUX1)

Base 0x4003.8000  
 Offset 0x060  
 Type RO, reset 0x0000.0000



Bit/Field	Name	Type	Reset	Description
31:15	reserved	RO	0x00	Software should not rely on the value of a reserved bit. To provide compatibility with future products, the value of a reserved bit should be preserved across a read-modify-write operation.
14:12	MUX3	R/W	0	4th Sample Input Select
11	reserved	RO	0	Software should not rely on the value of a reserved bit. To provide compatibility with future products, the value of a reserved bit should be preserved across a read-modify-write operation.
10:8	MUX2	R/W	0	3rd Sample Input Select
7	reserved	RO	0	Software should not rely on the value of a reserved bit. To provide compatibility with future products, the value of a reserved bit should be preserved across a read-modify-write operation.
6:4	MUX1	R/W	0	2nd Sample Input Select
3	reserved	RO	0	Software should not rely on the value of a reserved bit. To provide compatibility with future products, the value of a reserved bit should be preserved across a read-modify-write operation.
2:0	MUX0	R/W	0	1st Sample Input Select

**Register 23: ADC Sample Sequence Control 1 (ADCSSCTL1), offset 0x064**

**Register 24: ADC Sample Sequence Control 2 (ADCSSCTL2), offset 0x084**

These registers contain the configuration information for each sample for a sequence executed with Sample Sequencer 1 or 2. When configuring a sample sequence, the **END** bit must be set at some point, whether it be after the first sample, last sample, or any sample in between. This register is 16-bits wide and contains information for four possible samples. See the **ADCSSCTL0** register on page 278 for detailed bit descriptions.

ADC Sample Sequence Control 1 (ADCSSCTL1)

Base 0x4003.8000  
 Offset 0x064  
 Type RO, reset 0x0000.0000

	31	30	29	28	27	26	25	24	23	22	21	20	19	18	17	16
	reserved															
Type	RO	RO	RO	RO	RO	RO	RO	RO	RO	RO	RO	RO	RO	RO	RO	RO
Reset	0	0	0	0	0	0	0	0	0	0	0	0	0	0	0	0
	15	14	13	12	11	10	9	8	7	6	5	4	3	2	1	0
	TS3	IE3	END3	D3	TS2	IE2	END2	D2	TS1	IE1	END1	D1	TS0	IE0	END0	D0
Type	R/W	R/W	R/W	R/W	R/W	R/W	R/W	R/W	R/W	R/W	R/W	R/W	R/W	R/W	R/W	R/W
Reset	0	0	0	0	0	0	0	0	0	0	0	0	0	0	0	0

Bit/Field	Name	Type	Reset	Description
31:16	reserved	RO	0x00	Software should not rely on the value of a reserved bit. To provide compatibility with future products, the value of a reserved bit should be preserved across a read-modify-write operation.
15	TS3	R/W	0	4th Sample Temp Sensor Select Same definition as <b>TS7</b> but used during the fourth sample.
14	IE3	R/W	0	4th Sample Interrupt Enable Same definition as <b>IE7</b> but used during the fourth sample.
13	END3	R/W	0	4th Sample is End of Sequence Same definition as <b>END7</b> but used during the fourth sample.
12	D3	R/W	0	4th Sample Diff Input Select Same definition as <b>D7</b> but used during the fourth sample.
11	TS2	R/W	0	3rd Sample Temp Sensor Select Same definition as <b>TS7</b> but used during the third sample.
10	IE2	R/W	0	3rd Sample Interrupt Enable Same definition as <b>IE7</b> but used during the third sample.
9	END2	R/W	0	3rd Sample is End of Sequence Same definition as <b>END7</b> but used during the third sample.
8	D2	R/W	0	3rd Sample Diff Input Select Same definition as <b>D7</b> but used during the third sample.

Bit/Field	Name	Type	Reset	Description
7	TS1	R/W	0	2nd Sample Temp Sensor Select Same definition as TS7 but used during the second sample.
6	IE1	R/W	0	2nd Sample Interrupt Enable Same definition as IE7 but used during the second sample.
5	END1	R/W	0	2nd Sample is End of Sequence Same definition as END7 but used during the second sample.
4	D1	R/W	0	2nd Sample Diff Input Select Same definition as D7 but used during the second sample.
3	TS0	R/W	0	1st Sample Temp Sensor Select Same definition as TS7 but used during the first sample.
2	IE0	R/W	0	1st Sample Interrupt Enable Same definition as IE7 but used during the first sample.
1	END0	R/W	0	1st Sample is End of Sequence Same definition as END7 but used during the first sample. Since this sequencer has only one entry, this bit must be set.
0	D0	R/W	0	1st Sample Diff Input Select Same definition as D7 but used during the first sample.

### Register 25: ADC Sample Sequence Input Multiplexer Select 3 (ADCSSMUX3), offset 0x0A0

This register defines the analog input configuration for each sample in a sequence executed with Sample Sequencer 3. This register is 4-bits wide and contains information for one possible sample. See the **ADCSSMUX0** register on page 276 for detailed bit descriptions.

#### ADC Sample Sequence Input Multiplexer Select 3 (ADCSSMUX3)

Base 0x4003.8000  
 Offset 0x0A0  
 Type R/W, reset 0x0000.0000

	31	30	29	28	27	26	25	24	23	22	21	20	19	18	17	16
	reserved															
Type	RO	RO	RO	RO	RO	RO	RO	RO	RO	RO	RO	RO	RO	RO	RO	RO
Reset	0	0	0	0	0	0	0	0	0	0	0	0	0	0	0	0
	15	14	13	12	11	10	9	8	7	6	5	4	3	2	1	0
	reserved													MUX0		
Type	RO	RO	RO	RO	RO	RO	RO	RO	RO	RO	RO	RO	RO	R/W	R/W	R/W
Reset	0	0	0	0	0	0	0	0	0	0	0	0	0	0	0	0

Bit/Field	Name	Type	Reset	Description
31:3	reserved	RO	0x00	Software should not rely on the value of a reserved bit. To provide compatibility with future products, the value of a reserved bit should be preserved across a read-modify-write operation.
2:0	MUX0	R/W	0	1st Sample Input Select

**Register 26: ADC Sample Sequence Control 3 (ADCSSCTL3), offset 0x0A4**

This register contains the configuration information for each sample for a sequence executed with Sample Sequencer 3. The `END` bit is always set since there is only one sample in this sequencer. This register is 4-bits wide and contains information for one possible sample. See the **ADCSSCTL0** register on page 278 for detailed bit descriptions.

## ADC Sample Sequence Control 3 (ADCSSCTL3)

Base 0x4003.8000  
Offset 0x0A4  
Type R/W, reset 0x0000.0002

	31	30	29	28	27	26	25	24	23	22	21	20	19	18	17	16
	reserved															
Type	RO	RO	RO	RO	RO	RO	RO	RO	RO	RO	RO	RO	RO	RO	RO	RO
Reset	0	0	0	0	0	0	0	0	0	0	0	0	0	0	0	0
	15	14	13	12	11	10	9	8	7	6	5	4	3	2	1	0
	reserved												TS0	IE0	END0	D0
Type	RO	RO	RO	RO	RO	RO	RO	RO	RO	RO	RO	RO	R/W	R/W	R/W	R/W
Reset	0	0	0	0	0	0	0	0	0	0	0	0	0	0	1	0

Bit/Field	Name	Type	Reset	Description
31:4	reserved	RO	0x00	Software should not rely on the value of a reserved bit. To provide compatibility with future products, the value of a reserved bit should be preserved across a read-modify-write operation.
3	TS0	R/W	0	1st Sample Temp Sensor Select Same definition as <code>TS7</code> but used during the first sample.
2	IE0	R/W	0	1st Sample Interrupt Enable Same definition as <code>IE7</code> but used during the first sample.
1	END0	R/W	1	1st Sample is End of Sequence Same definition as <code>END7</code> but used during the first sample. Since this sequencer has only one entry, this bit must be set.
0	D0	R/W	0	1st Sample Diff Input Select Same definition as <code>D7</code> but used during the first sample.

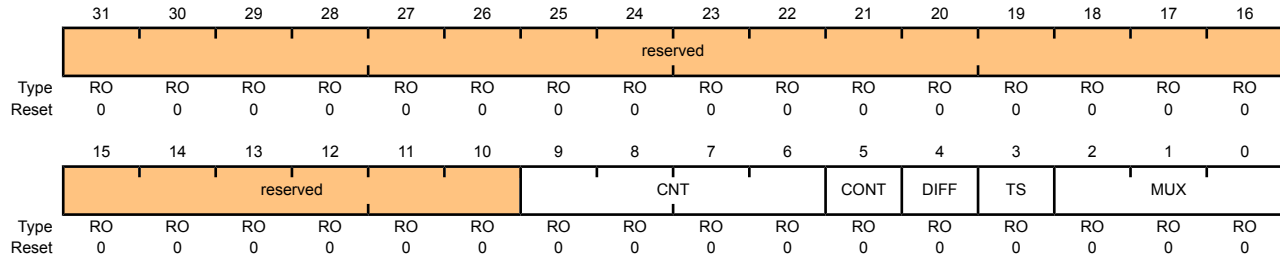
### Register 27: ADC Test Mode Loopback (ADCTMLB), offset 0x100

This register provides loopback operation within the digital logic of the ADC, which can be useful in debugging software without having to provide actual analog stimulus. This test mode is entered by writing a value of 0x0000.0001 to this register. When data is read from the FIFO in loopback mode, the read-only portion of this register is returned.

#### Read-Only Register

#### ADC Test Mode Loopback (ADCTMLB)

Base 0x4003.8000  
 Offset 0x100  
 Type RO, reset 0x0000.0000



Bit/Field	Name	Type	Reset	Description
31:10	reserved	RO	0x00	Software should not rely on the value of a reserved bit. To provide compatibility with future products, the value of a reserved bit should be preserved across a read-modify-write operation.
9:6	CNT	RO	0x0	Continuous Sample Counter  Continuous sample counter that is initialized to 0 and counts each sample as it processed. This helps provide a unique value for the data received.
5	CONT	RO	0	Continuation Sample Indicator  When set, indicates that this is a continuation sample. For example, if two sequencers were to run back-to-back, this indicates that the controller kept continuously sampling at full rate.
4	DIFF	RO	0	Differential Sample Indicator  When set, indicates that this is a differential sample.
3	TS	RO	0	Temp Sensor Sample Indicator  When set, indicates that this is a temperature sensor sample.
2:0	MUX	RO	0x0	Analog Input Indicator  Indicates which analog input is to be sampled.



## Write-Only Register

### ADC Test Mode Loopback (ADCTMLB)

Base 0x4003.8000

Offset 0x100

Type WO, reset 0x0000.0000

	31	30	29	28	27	26	25	24	23	22	21	20	19	18	17	16
	reserved															
Type	RO	RO	RO	RO	RO	RO	RO	RO	RO	RO	RO	RO	RO	RO	RO	RO
Reset	0	0	0	0	0	0	0	0	0	0	0	0	0	0	0	0
	15	14	13	12	11	10	9	8	7	6	5	4	3	2	1	0
	reserved															
Type	RO	RO	RO	RO	RO	RO	RO	RO	RO	RO	RO	RO	RO	RO	RO	WO
Reset	0	0	0	0	0	0	0	0	0	0	0	0	0	0	0	0

Bit/Field	Name	Type	Reset	Description
31:1	reserved	RO	0x00	Software should not rely on the value of a reserved bit. To provide compatibility with future products, the value of a reserved bit should be preserved across a read-modify-write operation.
0	LB	WO	0	<p>Loopback Mode Enable</p> <p>When set, forces a loopback within the digital block to provide information on input and unique numbering.</p> <p>The 10-bit loopback data is defined as shown in the read for bits 9:0 above.</p>

## 13 Universal Asynchronous Receivers/Transmitters (UARTs)

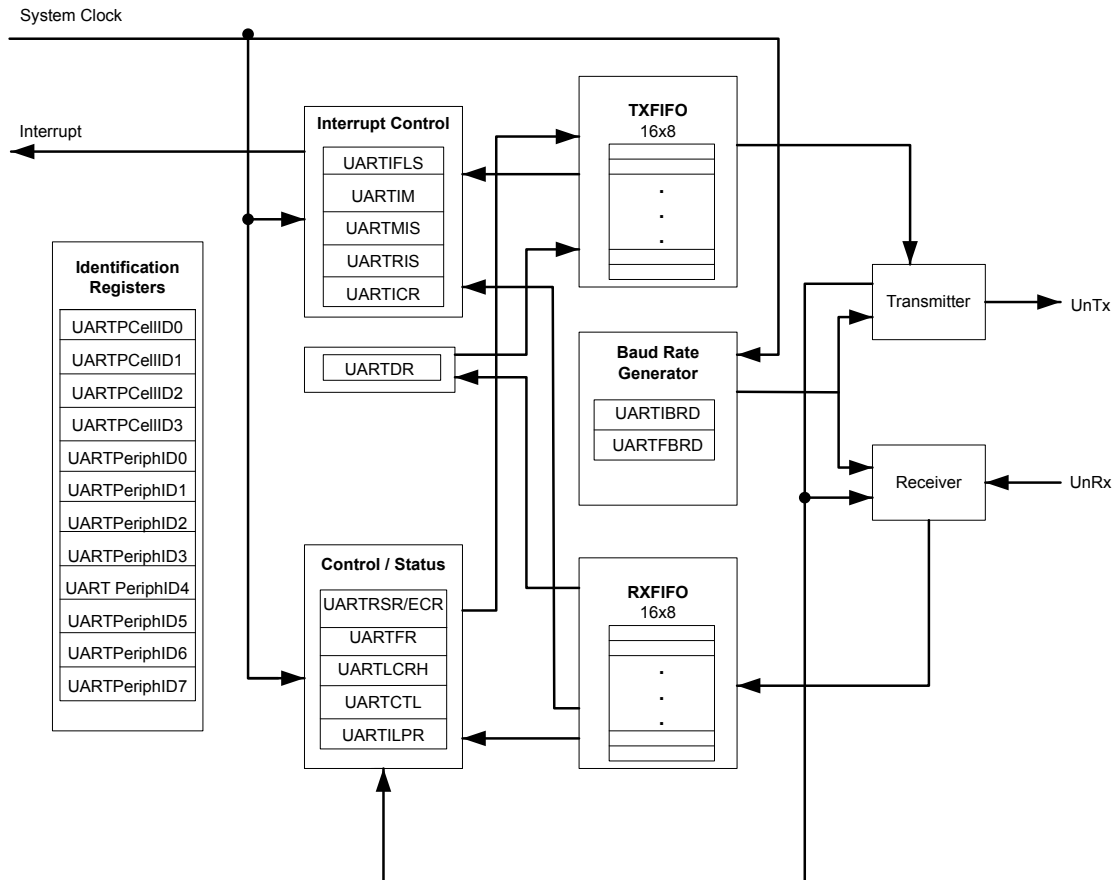
The Stellaris<sup>®</sup> Universal Asynchronous Receiver/Transmitter (UART) provides fully programmable, 16C550-type serial interface characteristics. The LM3S1138 controller is equipped with three UART modules.

Each UART has the following features:

- Separate transmit and receive FIFOs
- Programmable FIFO length, including 1-byte deep operation providing conventional double-buffered interface
- FIFO trigger levels of 1/8, 1/4, 1/2, 3/4, and 7/8
- Programmable baud-rate generator allowing rates up to 3.125 Mbps
- Standard asynchronous communication bits for start, stop, and parity
- False start bit detection
- Line-break generation and detection
- Fully programmable serial interface characteristics:
  - 5, 6, 7, or 8 data bits
  - Even, odd, stick, or no-parity bit generation/detection
  - 1 or 2 stop bit generation
- IrDA serial-IR (SIR) encoder/decoder providing:
  - Programmable use of IrDA Serial InfraRed (SIR) or UART input/output
  - Support of IrDA SIR encoder/decoder functions for data rates up to 115.2 Kbps half-duplex
  - Support of normal 3/16 and low-power (1.41-2.23  $\mu$ s) bit durations
  - Programmable internal clock generator enabling division of reference clock by 1 to 256 for low-power mode bit duration

## 13.1 Block Diagram

Figure 13-1. UART Module Block Diagram



## 13.2 Functional Description

Each Stellaris<sup>®</sup> UART performs the functions of parallel-to-serial and serial-to-parallel conversions. It is similar in functionality to a 16C550 UART, but is not register compatible.

The UART is configured for transmit and/or receive via the `TXE` and `RXE` bits of the **UART Control (UARTCTL)** register (see page 309). Transmit and receive are both enabled out of reset. Before any control registers are programmed, the UART must be disabled by clearing the `UARTEN` bit in **UARTCTL**. If the UART is disabled during a TX or RX operation, the current transaction is completed prior to the UART stopping.

The UART peripheral also includes a serial IR (SIR) encoder/decoder block that can be connected to an infrared transceiver to implement an IrDA SIR physical layer. The SIR function is programmed using the `UARTCTL` register.

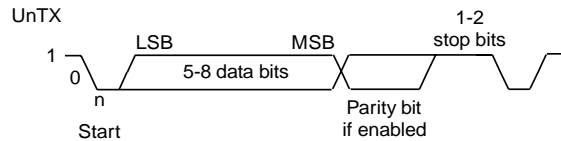
### 13.2.1 Transmit/Receive Logic

The transmit logic performs parallel-to-serial conversion on the data read from the transmit FIFO. The control logic outputs the serial bit stream beginning with a start bit, and followed by the data

bits (LSB first), parity bit, and the stop bits according to the programmed configuration in the control registers. See Figure 13-2 on page 292 for details.

The receive logic performs serial-to-parallel conversion on the received bit stream after a valid start pulse has been detected. Overrun, parity, frame error checking, and line-break detection are also performed, and their status accompanies the data that is written to the receive FIFO.

**Figure 13-2. UART Character Frame**



### 13.2.2 Baud-Rate Generation

The baud-rate divisor is a 22-bit number consisting of a 16-bit integer and a 6-bit fractional part. The number formed by these two values is used by the baud-rate generator to determine the bit period. Having a fractional baud-rate divider allows the UART to generate all the standard baud rates.

The 16-bit integer is loaded through the **UART Integer Baud-Rate Divisor (UARTIBRD)** register (see page 305) and the 6-bit fractional part is loaded with the **UART Fractional Baud-Rate Divisor (UARTFBRD)** register (see page 306). The baud-rate divisor (BRD) has the following relationship to the system clock (where *BRDI* is the integer part of the BRD and *BRDF* is the fractional part, separated by a decimal place.):

$$BRD = BRDI + BRDF = \text{SysClk} / (16 * \text{Baud Rate})$$

The 6-bit fractional number (that is to be loaded into the *DIVFRAC* bit field in the **UARTFBRD** register) can be calculated by taking the fractional part of the baud-rate divisor, multiplying it by 64, and adding 0.5 to account for rounding errors:

$$\text{UARTFBRD}[\text{DIVFRAC}] = \text{integer}(\text{BRDF} * 64 + 0.5)$$

The UART generates an internal baud-rate reference clock at 16x the baud-rate (referred to as *Baud16*). This reference clock is divided by 16 to generate the transmit clock, and is used for error detection during receive operations.

Along with the **UART Line Control, High Byte (UARTLCRH)** register (see page 307), the **UARTIBRD** and **UARTFBRD** registers form an internal 30-bit register. This internal register is only updated when a write operation to **UARTLCRH** is performed, so any changes to the baud-rate divisor must be followed by a write to the **UARTLCRH** register for the changes to take effect.

To update the baud-rate registers, there are four possible sequences:

- **UARTIBRD** write, **UARTFBRD** write, and **UARTLCRH** write
- **UARTFBRD** write, **UARTIBRD** write, and **UARTLCRH** write
- **UARTIBRD** write and **UARTLCRH** write
- **UARTFBRD** write and **UARTLCRH** write

### 13.2.3 Data Transmission

Data received or transmitted is stored in two 16-byte FIFOs, though the receive FIFO has an extra four bits per character for status information. For transmission, data is written into the transmit FIFO. If the UART is enabled, it causes a data frame to start transmitting with the parameters indicated in the **UARTLCRH** register. Data continues to be transmitted until there is no data left in the transmit FIFO. The **BUSY** bit in the **UART Flag (UARTFR)** register (see page 302) is asserted as soon as data is written to the transmit FIFO (that is, if the FIFO is non-empty) and remains asserted while data is being transmitted. The **BUSY** bit is negated only when the transmit FIFO is empty, and the last character has been transmitted from the shift register, including the stop bits. The UART can indicate that it is busy even though the UART may no longer be enabled.

When the receiver is idle (the **UnRx** is continuously 1) and the data input goes Low (a start bit has been received), the receive counter begins running and data is sampled on the eighth cycle of **Baud16** (described in “Transmit/Receive Logic” on page 291).

The start bit is valid if **UnRx** is still low on the eighth cycle of **Baud16**, otherwise a false start bit is detected and it is ignored. Start bit errors can be viewed in the **UART Receive Status (UARTSR)** register (see page 300). If the start bit was valid, successive data bits are sampled on every 16th cycle of **Baud16** (that is, one bit period later) according to the programmed length of the data characters. The parity bit is then checked if parity mode was enabled. Data length and parity are defined in the **UARTLCRH** register.

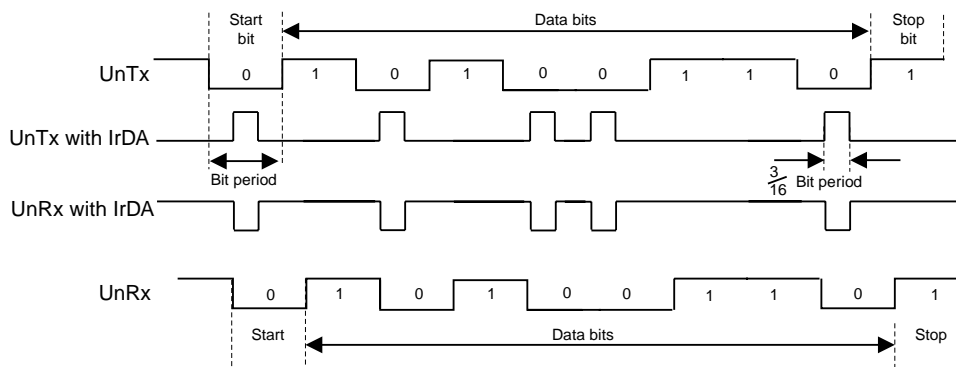
Lastly, a valid stop bit is confirmed if **UnRx** is High, otherwise a framing error has occurred. When a full word is received, the data is stored in the receive FIFO, with any error bits associated with that word.

### 13.2.4 Serial IR (SIR)

The UART peripheral includes an IrDA serial-IR (SIR) encoder/decoder block. The IrDA SIR block provides functionality that converts between an asynchronous UART data stream, and half-duplex serial SIR interface. No analog processing is performed on-chip. The role of the SIR block is to provide a digital encoded output, and decoded input to the UART. The UART signal pins can be connected to an infrared transceiver to implement an IrDA SIR physical layer link. The SIR block has two modes of operation:

- In normal IrDA mode, a zero logic level is transmitted as high pulse of 3/16th duration of the selected baud rate bit period on the output pin, while logic one levels are transmitted as a static LOW signal. These levels control the driver of an infrared transmitter, sending a pulse of light for each zero. On the reception side, the incoming light pulses energize the photo transistor base of the receiver, pulling its output LOW. This drives the UART input pin LOW.
- In low-power IrDA mode, the width of the transmitted infrared pulse is set to three times the period of the internally generated **IrLPBaud16** signal (1.63  $\mu$ s, assuming a nominal 1.8432 MHz frequency) by changing the appropriate bit in the **UARTCR** register.

Figure 13-3 on page 294 shows the UART transmit and receive signals, with and without IrDA modulation.

**Figure 13-3. IrDA Data Modulation**


In both normal and low-power IrDA modes:

- During transmission, the UART data bit is used as the base for encoding
- During reception, the decoded bits are transferred to the UART receive logic

The IrDA SIR physical layer specifies a half-duplex communication link, with a minimum 10 ms delay between transmission and reception. This delay must be generated by software because it is not automatically supported by the UART. The delay is required because the infrared receiver electronics might become biased, or even saturated from the optical power coupled from the adjacent transmitter LED. This delay is known as latency, or receiver setup time.

### 13.2.5 FIFO Operation

The UART has two 16-entry FIFOs; one for transmit and one for receive. Both FIFOs are accessed via the **UART Data (UARTDR)** register (see page 298). Read operations of the **UARTDR** register return a 12-bit value consisting of 8 data bits and 4 error flags while write operations place 8-bit data in the transmit FIFO.

Out of reset, both FIFOs are disabled and act as 1-byte-deep holding registers. The FIFOs are enabled by setting the **FEN** bit in **UARTLCRH** (page 307).

FIFO status can be monitored via the **UART Flag (UARTFR)** register (see page 302) and the **UART Receive Status (UARTRSR)** register. Hardware monitors empty, full and overrun conditions. The **UARTFR** register contains empty and full flags (**TXFE**, **TXFF**, **RXFE**, and **RXFF** bits) and the **UARTRSR** register shows overrun status via the **OE** bit.

The trigger points at which the FIFOs generate interrupts is controlled via the **UART Interrupt FIFO Level Select (UARTIFLS)** register (see page 311). Both FIFOs can be individually configured to trigger interrupts at different levels. Available configurations include  $\frac{1}{8}$ ,  $\frac{1}{4}$ ,  $\frac{1}{2}$ ,  $\frac{3}{4}$ , and  $\frac{7}{8}$ . For example, if the  $\frac{1}{4}$  option is selected for the receive FIFO, the UART generates a receive interrupt after 4 data bytes are received. Out of reset, both FIFOs are configured to trigger an interrupt at the  $\frac{1}{2}$  mark.

### 13.2.6 Interrupts

The UART can generate interrupts when the following conditions are observed:

- Overrun Error
- Break Error

- Parity Error
- Framing Error
- Receive Timeout
- Transmit (when condition defined in the `TXIFLSEL` bit in the **UARTIFLS** register is met)
- Receive (when condition defined in the `RXIFLSEL` bit in the **UARTIFLS** register is met)

All of the interrupt events are ORed together before being sent to the interrupt controller, so the UART can only generate a single interrupt request to the controller at any given time. Software can service multiple interrupt events in a single interrupt service routine by reading the **UART Masked Interrupt Status (UARTMIS)** register (see page 316).

The interrupt events that can trigger a controller-level interrupt are defined in the **UART Interrupt Mask (UARTIM)** register (see page 313) by setting the corresponding `IM` bit to 1. If interrupts are not used, the raw interrupt status is always visible via the **UART Raw Interrupt Status (UARTRIS)** register (see page 315).

Interrupts are always cleared (for both the **UARTMIS** and **UARTRIS** registers) by setting the corresponding bit in the **UART Interrupt Clear (UARTICR)** register (see page 317).

The receive timeout interrupt is asserted when the receive FIFO is not empty, and no further data is received over a 32-bit period. The receive timeout interrupt is cleared either when the FIFO becomes empty through reading all the data (or by reading the holding register), or when a 1 is written to the corresponding bit in the **UARTICR** register.

### 13.2.7 Loopback Operation

The UART can be placed into an internal loopback mode for diagnostic or debug work. This is accomplished by setting the `LBE` bit in the **UARTCTL** register (see page 309). In loopback mode, data transmitted on `UnTx` is received on the `UnRx` input.

### 13.2.8 IrDA SIR block

The IrDA SIR block contains an IrDA serial IR (SIR) protocol encoder/decoder. When enabled, the SIR block uses the `UnTx` and `UnRx` pins for the SIR protocol, which should be connected to an IR transceiver.

The SIR block can receive and transmit, but it is only half-duplex so it cannot do both at the same time. Transmission must be stopped before data can be received. The IrDA SIR physical layer specifies a minimum 10-ms delay between transmission and reception.

## 13.3 Initialization and Configuration

To use the UARTs, the peripheral clock must be enabled by setting the `UART0`, `UART1`, or `UART2` bits in the **RCGC1** register.

This section discusses the steps that are required for using a UART module. For this example, the system clock is assumed to be 20 MHz and the desired UART configuration is:

- 115200 baud rate
- Data length of 8 bits
- One stop bit

- No parity
- FIFOs disabled
- No interrupts

The first thing to consider when programming the UART is the baud-rate divisor (BRD), since the **UARTIBRD** and **UARTFBRD** registers must be written before the **UARTLCRH** register. Using the equation described in “Baud-Rate Generation” on page 292, the BRD can be calculated:

$$BRD = 20,000,000 / (16 * 115,200) = 10.8507$$

which means that the `DIVINT` field of the **UARTIBRD** register (see page 305) should be set to 10. The value to be loaded into the **UARTFBRD** register (see page 306) is calculated by the equation:

$$UARTFBRD[DIVFRAC] = \text{integer}(0.8507 * 64 + 0.5) = 54$$

With the BRD values in hand, the UART configuration is written to the module in the following order:

1. Disable the UART by clearing the `UARTEN` bit in the **UARTCTL** register.
2. Write the integer portion of the BRD to the **UARTIBRD** register.
3. Write the fractional portion of the BRD to the **UARTFBRD** register.
4. Write the desired serial parameters to the **UARTLCRH** register (in this case, a value of 0x0000.0060).
5. Enable the UART by setting the `UARTEN` bit in the **UARTCTL** register.

## 13.4 Register Map

Table 13-1 on page 296 lists the UART registers. The offset listed is a hexadecimal increment to the register’s address, relative to that UART’s base address:

- UART0: 0x4000.C000
- UART1: 0x4000.D000
- UART2: 0x4000.E000

**Note:** The UART must be disabled (see the `UARTEN` bit in the **UARTCTL** register on page 309) before any of the control registers are reprogrammed. When the UART is disabled during a TX or RX operation, the current transaction is completed prior to the UART stopping.

**Table 13-1. UART Register Map**

Offset	Name	Type	Reset	Description	See page
0x000	UARTDR	R/W	0x0000.0000	UART Data	298
0x004	UARTSR/UARTECR	R/W	0x0000.0000	UART Receive Status/Error Clear	300
0x018	UARTFR	RO	0x0000.0090	UART Flag	302
0x020	UARTILPR	R/W	0x0000.0000	UART IrDA Low-Power Register	304



Offset	Name	Type	Reset	Description	See page
0x024	UARTIBRD	R/W	0x0000.0000	UART Integer Baud-Rate Divisor	305
0x028	UARTFBRD	R/W	0x0000.0000	UART Fractional Baud-Rate Divisor	306
0x02C	UARTLCRH	R/W	0x0000.0000	UART Line Control	307
0x030	UARTCTL	R/W	0x0000.0300	UART Control	309
0x034	UARTIFLS	R/W	0x0000.0012	UART Interrupt FIFO Level Select	311
0x038	UARTIM	R/W	0x0000.0000	UART Interrupt Mask	313
0x03C	UARTRIS	RO	0x0000.000F	UART Raw Interrupt Status	315
0x040	UARTMIS	RO	0x0000.0000	UART Masked Interrupt Status	316
0x044	UARTICR	W1C	0x0000.0000	UART Interrupt Clear	317
0xFD0	UARTPeriphID4	RO	0x0000.0000	UART Peripheral Identification 4	319
0xFD4	UARTPeriphID5	RO	0x0000.0000	UART Peripheral Identification 5	320
0xFD8	UARTPeriphID6	RO	0x0000.0000	UART Peripheral Identification 6	321
0xFDC	UARTPeriphID7	RO	0x0000.0000	UART Peripheral Identification 7	322
0xFE0	UARTPeriphID0	RO	0x0000.0011	UART Peripheral Identification 0	323
0xFE4	UARTPeriphID1	RO	0x0000.0000	UART Peripheral Identification 1	324
0xFE8	UARTPeriphID2	RO	0x0000.0018	UART Peripheral Identification 2	325
0xFEC	UARTPeriphID3	RO	0x0000.0001	UART Peripheral Identification 3	326
0xFF0	UARTPCellID0	RO	0x0000.000D	UART PrimeCell Identification 0	327
0xFF4	UARTPCellID1	RO	0x0000.00F0	UART PrimeCell Identification 1	328
0xFF8	UARTPCellID2	RO	0x0000.0005	UART PrimeCell Identification 2	329
0xFFC	UARTPCellID3	RO	0x0000.00B1	UART PrimeCell Identification 3	330

## 13.5 Register Descriptions

The remainder of this section lists and describes the UART registers, in numerical order by address offset.

### Register 1: UART Data (UARTDR), offset 0x000

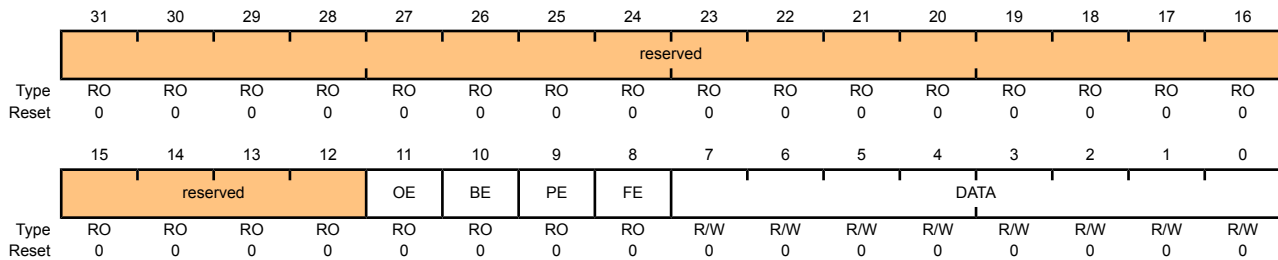
This register is the data register (the interface to the FIFOs).

When FIFOs are enabled, data written to this location is pushed onto the transmit FIFO. If FIFOs are disabled, data is stored in the transmitter holding register (the bottom word of the transmit FIFO). A write to this register initiates a transmission from the UART.

For received data, if the FIFO is enabled, the data byte and the 4-bit status (break, frame, parity, and overrun) is pushed onto the 12-bit wide receive FIFO. If FIFOs are disabled, the data byte and status are stored in the receiving holding register (the bottom word of the receive FIFO). The received data can be retrieved by reading this register.

#### UART Data (UARTDR)

UART0 base: 0x4000.C000  
 UART1 base: 0x4000.D000  
 UART2 base: 0x4000.E000  
 Offset 0x000  
 Type R/W, reset 0x0000.0000



Bit/Field	Name	Type	Reset	Description						
31:12	reserved	RO	0	Software should not rely on the value of a reserved bit. To provide compatibility with future products, the value of a reserved bit should be preserved across a read-modify-write operation.						
11	OE	RO	0	UART Overrun Error  The OE values are defined as follows:  <table border="1"> <thead> <tr> <th>Value</th> <th>Description</th> </tr> </thead> <tbody> <tr> <td>0</td> <td>There has been no data loss due to a FIFO overrun.</td> </tr> <tr> <td>1</td> <td>New data was received when the FIFO was full, resulting in data loss.</td> </tr> </tbody> </table>	Value	Description	0	There has been no data loss due to a FIFO overrun.	1	New data was received when the FIFO was full, resulting in data loss.
Value	Description									
0	There has been no data loss due to a FIFO overrun.									
1	New data was received when the FIFO was full, resulting in data loss.									
10	BE	RO	0	UART Break Error  This bit is set to 1 when a break condition is detected, indicating that the receive data input was held Low for longer than a full-word transmission time (defined as start, data, parity, and stop bits).  In FIFO mode, this error is associated with the character at the top of the FIFO. When a break occurs, only one 0 character is loaded into the FIFO. The next character is only enabled after the received data input goes to a 1 (marking state) and the next valid start bit is received.						

---

Bit/Field	Name	Type	Reset	Description
9	PE	RO	0	UART Parity Error This bit is set to 1 when the parity of the received data character does not match the parity defined by bits 2 and 7 of the <b>UARTLCRH</b> register. In FIFO mode, this error is associated with the character at the top of the FIFO.
8	FE	RO	0	UART Framing Error This bit is set to 1 when the received character does not have a valid stop bit (a valid stop bit is 1).
7:0	DATA	R/W	0	Data Transmitted or Received When written, the data that is to be transmitted via the UART. When read, the data that was received by the UART.

## Register 2: UART Receive Status/Error Clear (UARTRSR/UARTECR), offset 0x004

The **UARTRSR/UARTECR** register is the receive status register/error clear register.

In addition to the **UARTDR** register, receive status can also be read from the **UARTRSR** register. If the status is read from this register, then the status information corresponds to the entry read from **UARTDR** prior to reading **UARTRSR**. The status information for overrun is set immediately when an overrun condition occurs.

A write of any value to the **UARTECR** register clears the framing, parity, break, and overrun errors. All the bits are cleared to 0 on reset.

### Read-Only Receive Status (UARTRSR) Register

#### UART Receive Status/Error Clear (UARTRSR/UARTECR)

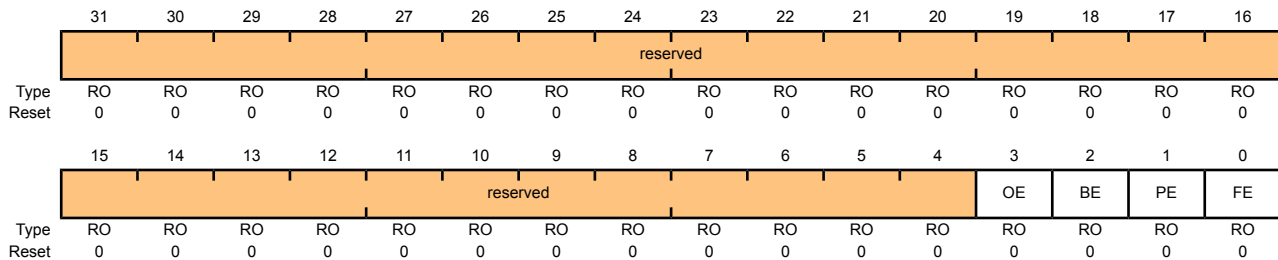
UART0 base: 0x4000.C000

UART1 base: 0x4000.D000

UART2 base: 0x4000.E000

Offset 0x004

Type RO, reset 0x0000.0000



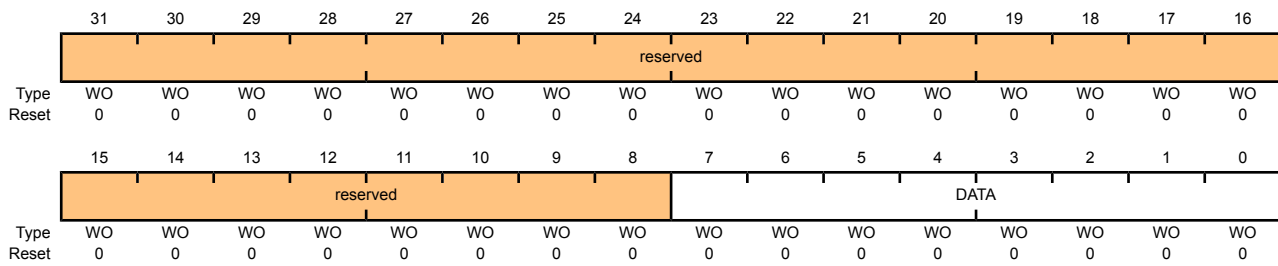
Bit/Field	Name	Type	Reset	Description
31:4	reserved	RO	0	Software should not rely on the value of a reserved bit. To provide compatibility with future products, the value of a reserved bit should be preserved across a read-modify-write operation.  The <b>UARTRSR</b> register cannot be written.
3	OE	RO	0	UART Overrun Error  When this bit is set to 1, data is received and the FIFO is already full. This bit is cleared to 0 by a write to <b>UARTECR</b> .  The FIFO contents remain valid since no further data is written when the FIFO is full, only the contents of the shift register are overwritten. The CPU must now read the data in order to empty the FIFO.
2	BE	RO	0	UART Break Error  This bit is set to 1 when a break condition is detected, indicating that the received data input was held Low for longer than a full-word transmission time (defined as start, data, parity, and stop bits).  This bit is cleared to 0 by a write to <b>UARTECR</b> .  In FIFO mode, this error is associated with the character at the top of the FIFO. When a break occurs, only one 0 character is loaded into the FIFO. The next character is only enabled after the receive data input goes to a 1 (marking state) and the next valid start bit is received.

Bit/Field	Name	Type	Reset	Description
1	PE	RO	0	<p>UART Parity Error</p> <p>This bit is set to 1 when the parity of the received data character does not match the parity defined by bits 2 and 7 of the <b>UARTLCRH</b> register.</p> <p>This bit is cleared to 0 by a write to <b>UARTECR</b>.</p>
0	FE	RO	0	<p>UART Framing Error</p> <p>This bit is set to 1 when the received character does not have a valid stop bit (a valid stop bit is 1).</p> <p>This bit is cleared to 0 by a write to <b>UARTECR</b>.</p> <p>In FIFO mode, this error is associated with the character at the top of the FIFO.</p>

**Write-Only Error Clear (UARTECR) Register**

UART Receive Status/Error Clear (UARTRSR/UARTECR)

UART0 base: 0x4000.C000  
 UART1 base: 0x4000.D000  
 UART2 base: 0x4000.E000  
 Offset 0x004  
 Type WO, reset 0x0000.0000



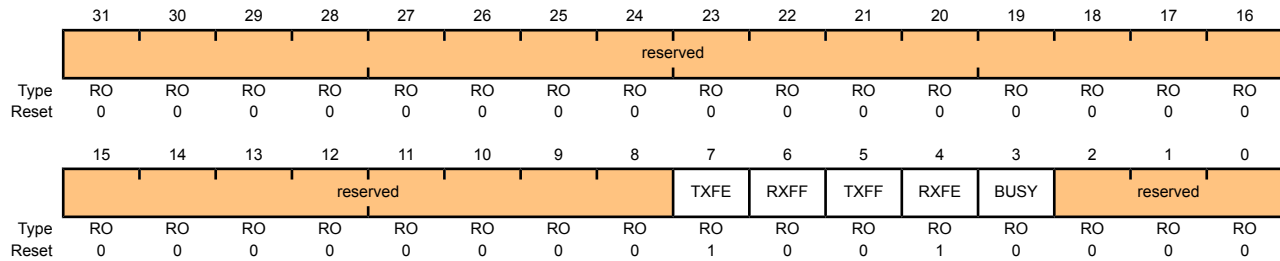
Bit/Field	Name	Type	Reset	Description
31:8	reserved	WO	0	<p>Software should not rely on the value of a reserved bit. To provide compatibility with future products, the value of a reserved bit should be preserved across a read-modify-write operation.</p>
7:0	DATA	WO	0	<p>Error Clear</p> <p>A write to this register of any data clears the framing, parity, break, and overrun flags.</p>

### Register 3: UART Flag (UARTFR), offset 0x018

The **UARTFR** register is the flag register. After reset, the **TXFF**, **RXFF**, and **BUSY** bits are 0, and **TXFE** and **RXFE** bits are 1.

#### UART Flag (UARTFR)

UART0 base: 0x4000.C000  
 UART1 base: 0x4000.D000  
 UART2 base: 0x4000.E000  
 Offset 0x018  
 Type RO, reset 0x0000.0090



Bit/Field	Name	Type	Reset	Description
31:8	reserved	RO	0	Software should not rely on the value of a reserved bit. To provide compatibility with future products, the value of a reserved bit should be preserved across a read-modify-write operation.
7	TXFE	RO	1	UART Transmit FIFO Empty  The meaning of this bit depends on the state of the <b>FEN</b> bit in the <b>UARTLCRH</b> register.  If the FIFO is disabled ( <b>FEN</b> is 0), this bit is set when the transmit holding register is empty.  If the FIFO is enabled ( <b>FEN</b> is 1), this bit is set when the transmit FIFO is empty.
6	RXFF	RO	0	UART Receive FIFO Full  The meaning of this bit depends on the state of the <b>FEN</b> bit in the <b>UARTLCRH</b> register.  If the FIFO is disabled, this bit is set when the receive holding register is full.  If the FIFO is enabled, this bit is set when the receive FIFO is full.
5	TXFF	RO	0	UART Transmit FIFO Full  The meaning of this bit depends on the state of the <b>FEN</b> bit in the <b>UARTLCRH</b> register.  If the FIFO is disabled, this bit is set when the transmit holding register is full.  If the FIFO is enabled, this bit is set when the transmit FIFO is full.

---

Bit/Field	Name	Type	Reset	Description
4	RXFE	RO	1	<p>UART Receive FIFO Empty</p> <p>The meaning of this bit depends on the state of the <code>FEN</code> bit in the <b>UARTLCRH</b> register.</p> <p>If the FIFO is disabled, this bit is set when the receive holding register is empty.</p> <p>If the FIFO is enabled, this bit is set when the receive FIFO is empty.</p>
3	BUSY	RO	0	<p>UART Busy</p> <p>When this bit is 1, the UART is busy transmitting data. This bit remains set until the complete byte, including all stop bits, has been sent from the shift register.</p> <p>This bit is set as soon as the transmit FIFO becomes non-empty (regardless of whether UART is enabled).</p>
2:0	reserved	RO	0	<p>Software should not rely on the value of a reserved bit. To provide compatibility with future products, the value of a reserved bit should be preserved across a read-modify-write operation.</p>

### Register 4: UART IrDA Low-Power Register (UARTILPR), offset 0x020

The **UARTILPR** register is an 8-bit read/write register that stores the low-power counter divisor value used to generate the  $F_{IrLPBaud16}$  signal by dividing down the system clock (SysClk). All the bits are cleared to 0 when reset.

The  $F_{IrLPBaud16}$  internal signal is generated by dividing down the **UARTCLK** signal according to the low-power divisor value written to **UARTILPR**. The low-power divisor value is calculated as follows:

$$ILPDVSR = SysClk / F_{IrLPBaud16}$$

where  $F_{IrLPBaud16}$  is nominally 1.8432 MHz.

$F_{IrLPBaud16}$  is an internal signal used for SIR pulse generation when low-power mode is used. You must choose the divisor so that  $1.42 \text{ MHz} < F_{IrLPBaud16} < 2.12 \text{ MHz}$ , which results in a low-power pulse duration of 1.41–2.11  $\mu\text{s}$  (three times the period of  $F_{IrLPBaud16}$ ). The minimum frequency of  $F_{IrLPBaud16}$  ensures that pulses less than one period of  $F_{IrLPBaud16}$  are rejected, but that pulses greater than 1.4  $\mu\text{s}$  are accepted as valid pulses.

**Note:** Zero is an illegal value. Programming a zero value results in no  $F_{IrLPBaud16}$  pulses being generated.

#### UART IrDA Low-Power Register (UARTILPR)

UART0 base: 0x4000.C000  
 UART1 base: 0x4000.D000  
 UART2 base: 0x4000.E000  
 Offset 0x020  
 Type R/W, reset 0x0000.0000

	31	30	29	28	27	26	25	24	23	22	21	20	19	18	17	16
	reserved															
Type	RO	RO	RO	RO	RO	RO	RO	RO	RO	RO	RO	RO	RO	RO	RO	RO
Reset	0	0	0	0	0	0	0	0	0	0	0	0	0	0	0	0
	15	14	13	12	11	10	9	8	7	6	5	4	3	2	1	0
	reserved								ILPDVSR							
Type	RO	RO	RO	RO	RO	RO	RO	RO	R/W	R/W	R/W	R/W	R/W	R/W	R/W	R/W
Reset	0	0	0	0	0	0	0	0	0	0	0	0	0	0	0	0

Bit/Field	Name	Type	Reset	Description
31:8	reserved	RO	0	Software should not rely on the value of a reserved bit. To provide compatibility with future products, the value of a reserved bit should be preserved across a read-modify-write operation.
7:0	ILPDVSR	R/W	0x00	IrDA Low-Power Divisor  This is an 8-bit low-power divisor value.

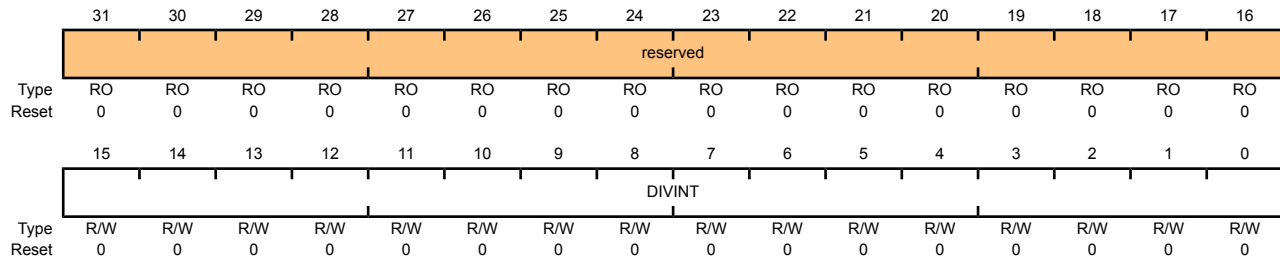


### Register 5: UART Integer Baud-Rate Divisor (UARTIBRD), offset 0x024

The **UARTIBRD** register is the integer part of the baud-rate divisor value. All the bits are cleared on reset. The minimum possible divide ratio is 1 (when **UARTIBRD**=0), in which case the **UARTFBRD** register is ignored. When changing the **UARTIBRD** register, the new value does not take effect until transmission/reception of the current character is complete. Any changes to the baud-rate divisor must be followed by a write to the **UARTLCRH** register. See “Baud-Rate Generation” on page 292 for configuration details.

#### UART Integer Baud-Rate Divisor (UARTIBRD)

UART0 base: 0x4000.C000  
 UART1 base: 0x4000.D000  
 UART2 base: 0x4000.E000  
 Offset 0x024  
 Type R/W, reset 0x0000.0000



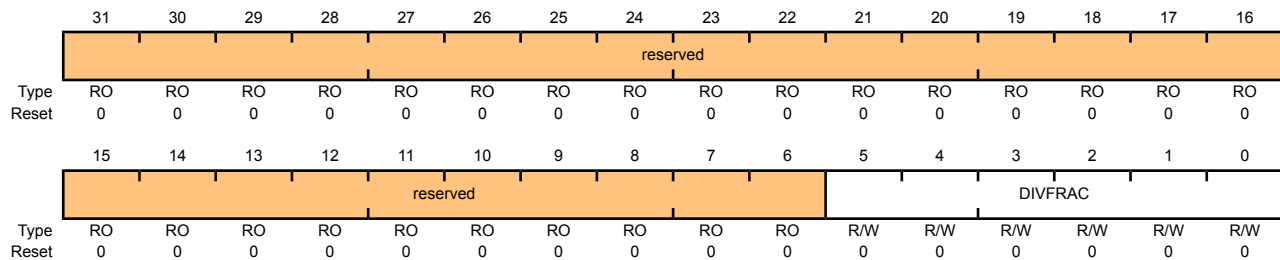
Bit/Field	Name	Type	Reset	Description
31:16	reserved	RO	0	Software should not rely on the value of a reserved bit. To provide compatibility with future products, the value of a reserved bit should be preserved across a read-modify-write operation.
15:0	DIVINT	R/W	0x0000	Integer Baud-Rate Divisor

### Register 6: UART Fractional Baud-Rate Divisor (UARTFBRD), offset 0x028

The **UARTFBRD** register is the fractional part of the baud-rate divisor value. All the bits are cleared on reset. When changing the **UARTFBRD** register, the new value does not take effect until transmission/reception of the current character is complete. Any changes to the baud-rate divisor must be followed by a write to the **UARTLCRH** register. See “Baud-Rate Generation” on page 292 for configuration details.

#### UART Fractional Baud-Rate Divisor (UARTFBRD)

UART0 base: 0x4000.C000  
 UART1 base: 0x4000.D000  
 UART2 base: 0x4000.E000  
 Offset 0x028  
 Type R/W, reset 0x0000.0000



Bit/Field	Name	Type	Reset	Description
31:6	reserved	RO	0x00	Software should not rely on the value of a reserved bit. To provide compatibility with future products, the value of a reserved bit should be preserved across a read-modify-write operation.
5:0	DIVFRAC	R/W	0x000	Fractional Baud-Rate Divisor

## Register 7: UART Line Control (UARTLCRH), offset 0x02C

The **UARTLCRH** register is the line control register. Serial parameters such as data length, parity, and stop bit selection are implemented in this register.

When updating the baud-rate divisor (**UARTIBRD** and/or **UARTIFRD**), the **UARTLCRH** register must also be written. The write strobe for the baud-rate divisor registers is tied to the **UARTLCRH** register.

### UART Line Control (UARTLCRH)

UART0 base: 0x4000.C000  
 UART1 base: 0x4000.D000  
 UART2 base: 0x4000.E000  
 Offset 0x02C  
 Type R/W, reset 0x0000.0000

	31	30	29	28	27	26	25	24	23	22	21	20	19	18	17	16
	reserved															
Type	RO	RO	RO	RO	RO	RO	RO	RO	RO	RO	RO	RO	RO	RO	RO	RO
Reset	0	0	0	0	0	0	0	0	0	0	0	0	0	0	0	0
	15	14	13	12	11	10	9	8	7	6	5	4	3	2	1	0
	reserved								SPS	WLEN		FEN	STP2	EPS	PEN	BRK
Type	RO	RO	RO	RO	RO	RO	RO	RO	R/W	R/W	R/W	R/W	R/W	R/W	R/W	R/W
Reset	0	0	0	0	0	0	0	0	0	0	0	0	0	0	0	0

Bit/Field	Name	Type	Reset	Description										
31:8	reserved	RO	0	Software should not rely on the value of a reserved bit. To provide compatibility with future products, the value of a reserved bit should be preserved across a read-modify-write operation.										
7	SPS	R/W	0	<p>UART Stick Parity Select</p> <p>When bits 1, 2, and 7 of <b>UARTLCRH</b> are set, the parity bit is transmitted and checked as a 0. When bits 1 and 7 are set and 2 is cleared, the parity bit is transmitted and checked as a 1.</p> <p>When this bit is cleared, stick parity is disabled.</p>										
6:5	WLEN	R/W	0	<p>UART Word Length</p> <p>The bits indicate the number of data bits transmitted or received in a frame as follows:</p> <table border="1"> <thead> <tr> <th>Value</th> <th>Description</th> </tr> </thead> <tbody> <tr> <td>0x3</td> <td>8 bits</td> </tr> <tr> <td>0x2</td> <td>7 bits</td> </tr> <tr> <td>0x1</td> <td>6 bits</td> </tr> <tr> <td>0x0</td> <td>5 bits (default)</td> </tr> </tbody> </table>	Value	Description	0x3	8 bits	0x2	7 bits	0x1	6 bits	0x0	5 bits (default)
Value	Description													
0x3	8 bits													
0x2	7 bits													
0x1	6 bits													
0x0	5 bits (default)													
4	FEN	R/W	0	<p>UART Enable FIFOs</p> <p>If this bit is set to 1, transmit and receive FIFO buffers are enabled (FIFO mode).</p> <p>When cleared to 0, FIFOs are disabled (Character mode). The FIFOs become 1-byte-deep holding registers.</p>										

Bit/Field	Name	Type	Reset	Description
3	STP2	R/W	0	<p>UART Two Stop Bits Select</p> <p>If this bit is set to 1, two stop bits are transmitted at the end of a frame. The receive logic does not check for two stop bits being received.</p>
2	EPS	R/W	0	<p>UART Even Parity Select</p> <p>If this bit is set to 1, even parity generation and checking is performed during transmission and reception, which checks for an even number of 1s in data and parity bits.</p> <p>When cleared to 0, then odd parity is performed, which checks for an odd number of 1s.</p> <p>This bit has no effect when parity is disabled by the <code>PEN</code> bit.</p>
1	PEN	R/W	0	<p>UART Parity Enable</p> <p>If this bit is set to 1, parity checking and generation is enabled; otherwise, parity is disabled and no parity bit is added to the data frame.</p>
0	BRK	R/W	0	<p>UART Send Break</p> <p>If this bit is set to 1, a Low level is continually output on the <code>U<sub>n</sub>TX</code> output, after completing transmission of the current character. For the proper execution of the break command, the software must set this bit for at least two frames (character periods). For normal use, this bit must be cleared to 0.</p>

## Register 8: UART Control (UARTCTL), offset 0x030

The **UARTCTL** register is the control register. All the bits are cleared on reset except for the Transmit Enable (TXE) and Receive Enable (RXE) bits, which are set to 1.

To enable the UART module, the **UARTEN** bit must be set to 1. If software requires a configuration change in the module, the **UARTEN** bit must be cleared before the configuration changes are written. If the UART is disabled during a transmit or receive operation, the current transaction is completed prior to the UART stopping.

### UART Control (UARTCTL)

UART0 base: 0x4000.C000  
 UART1 base: 0x4000.D000  
 UART2 base: 0x4000.E000  
 Offset 0x030  
 Type R/W, reset 0x0000.0300

	31	30	29	28	27	26	25	24	23	22	21	20	19	18	17	16
	reserved															
Type	RO	RO	RO	RO	RO	RO	RO	RO	RO	RO	RO	RO	RO	RO	RO	RO
Reset	0	0	0	0	0	0	0	0	0	0	0	0	0	0	0	0
	15	14	13	12	11	10	9	8	7	6	5	4	3	2	1	0
	reserved						RXE	TXE	LBE	reserved				SIRLP	SIREN	UARTEN
Type	RO	RO	RO	RO	RO	RO	R/W	R/W	R/W	RO	RO	RO	RO	R/W	R/W	R/W
Reset	0	0	0	0	0	0	1	1	0	0	0	0	0	0	0	0

Bit/Field	Name	Type	Reset	Description
31:10	reserved	RO	0	Software should not rely on the value of a reserved bit. To provide compatibility with future products, the value of a reserved bit should be preserved across a read-modify-write operation.
9	RXE	R/W	1	UART Receive Enable  If this bit is set to 1, the receive section of the UART is enabled. When the UART is disabled in the middle of a receive, it completes the current character before stopping.  <b>Note:</b> To enable reception, the <b>UARTEN</b> bit must also be set.
8	TXE	R/W	1	UART Transmit Enable  If this bit is set to 1, the transmit section of the UART is enabled. When the UART is disabled in the middle of a transmission, it completes the current character before stopping.  <b>Note:</b> To enable transmission, the <b>UARTEN</b> bit must also be set.
7	LBE	R/W	0	UART Loop Back Enable  If this bit is set to 1, the $U_nTX$ path is fed through the $U_nRX$ path.
6:3	reserved	RO	0	Software should not rely on the value of a reserved bit. To provide compatibility with future products, the value of a reserved bit should be preserved across a read-modify-write operation.

Bit/Field	Name	Type	Reset	Description
2	SIRLP	R/W	0	<p>UART SIR Low Power Mode</p> <p>This bit selects the IrDA encoding mode. If this bit is cleared to 0, low-level bits are transmitted as an active High pulse with a width of 3/16th of the bit period. If this bit is set to 1, low-level bits are transmitted with a pulse width which is 3 times the period of the <math>I_{rLPBaud16}</math> input signal, regardless of the selected bit rate. Setting this bit uses less power, but might reduce transmission distances. See page 304 for more information.</p>
1	SIREN	R/W	0	<p>UART SIR Enable</p> <p>If this bit is set to 1, the IrDA SIR block is enabled, and the UART will transmit and receive data using SIR protocol.</p>
0	UARTEN	R/W	0	<p>UART Enable</p> <p>If this bit is set to 1, the UART is enabled. When the UART is disabled in the middle of transmission or reception, it completes the current character before stopping.</p>

## Register 9: UART Interrupt FIFO Level Select (UARTIFLS), offset 0x034

The **UARTIFLS** register is the interrupt FIFO level select register. You can use this register to define the FIFO level at which the **TXRIS** and **RXRIS** bits in the **UARTRIS** register are triggered.

The interrupts are generated based on a transition through a level rather than being based on the level. That is, the interrupts are generated when the fill level progresses through the trigger level. For example, if the receive trigger level is set to the half-way mark, the interrupt is triggered as the module is receiving the 9th character.

Out of reset, the **TXIFLSEL** and **RXIFLSEL** bits are configured so that the FIFOs trigger an interrupt at the half-way mark.

### UART Interrupt FIFO Level Select (UARTIFLS)

UART0 base: 0x4000.C000  
 UART1 base: 0x4000.D000  
 UART2 base: 0x4000.E000  
 Offset 0x034  
 Type R/W, reset 0x0000.0012

	31	30	29	28	27	26	25	24	23	22	21	20	19	18	17	16
	reserved															
Type	RO	RO	RO	RO	RO	RO	RO	RO	RO	RO	RO	RO	RO	RO	RO	RO
Reset	0	0	0	0	0	0	0	0	0	0	0	0	0	0	0	0
	15	14	13	12	11	10	9	8	7	6	5	4	3	2	1	0
	reserved										RXIFLSEL			TXIFLSEL		
Type	RO	RO	RO	RO	RO	RO	RO	RO	RO	RO	R/W	R/W	R/W	R/W	R/W	R/W
Reset	0	0	0	0	0	0	0	0	0	0	0	1	0	0	1	0

Bit/Field	Name	Type	Reset	Description
31:6	reserved	RO	0x00	Software should not rely on the value of a reserved bit. To provide compatibility with future products, the value of a reserved bit should be preserved across a read-modify-write operation.
5:3	RXIFLSEL	R/W	0x2	UART Receive Interrupt FIFO Level Select

The trigger points for the receive interrupt are as follows:

Value	Description
0x0	RX FIFO $\geq$ 1/8 full
0x1	RX FIFO $\geq$ 1/4 full
0x2	RX FIFO $\geq$ 1/2 full (default)
0x3	RX FIFO $\geq$ 3/4 full
0x4	RX FIFO $\geq$ 7/8 full
0x5-0x7	Reserved

Bit/Field	Name	Type	Reset	Description
2:0	TXIFLSEL	R/W	0x2	UART Transmit Interrupt FIFO Level Select The trigger points for the transmit interrupt are as follows:  Value Description 0x0 TX FIFO $\leq$ 1/8 full 0x1 TX FIFO $\leq$ 1/4 full 0x2 TX FIFO $\leq$ 1/2 full (default) 0x3 TX FIFO $\leq$ 3/4 full 0x4 TX FIFO $\leq$ 7/8 full 0x5-0x7 Reserved



## Register 10: UART Interrupt Mask (UARTIM), offset 0x038

The **UARTIM** register is the interrupt mask set/clear register.

On a read, this register gives the current value of the mask on the relevant interrupt. Writing a 1 to a bit allows the corresponding raw interrupt signal to be routed to the interrupt controller. Writing a 0 prevents the raw interrupt signal from being sent to the interrupt controller.

### UART Interrupt Mask (UARTIM)

UART0 base: 0x4000.C000  
 UART1 base: 0x4000.D000  
 UART2 base: 0x4000.E000  
 Offset 0x038  
 Type R/W, reset 0x0000.0000

	31	30	29	28	27	26	25	24	23	22	21	20	19	18	17	16
	reserved															
Type	RO	RO	RO	RO	RO	RO	RO	RO	RO	RO	RO	RO	RO	RO	RO	RO
Reset	0	0	0	0	0	0	0	0	0	0	0	0	0	0	0	0
	15	14	13	12	11	10	9	8	7	6	5	4	3	2	1	0
	reserved					OEIM	BEIM	PEIM	FEIM	RTIM	TXIM	RXIM	reserved			
Type	RO	RO	RO	RO	RO	R/W	R/W	R/W	R/W	R/W	R/W	R/W	RO	RO	RO	RO
Reset	0	0	0	0	0	0	0	0	0	0	0	0	0	0	0	0

Bit/Field	Name	Type	Reset	Description
31:11	reserved	RO	0x00	Software should not rely on the value of a reserved bit. To provide compatibility with future products, the value of a reserved bit should be preserved across a read-modify-write operation.
10	OEIM	R/W	0	UART Overrun Error Interrupt Mask On a read, the current mask for the <b>OEIM</b> interrupt is returned. Setting this bit to 1 promotes the <b>OEIM</b> interrupt to the interrupt controller.
9	BEIM	R/W	0	UART Break Error Interrupt Mask On a read, the current mask for the <b>BEIM</b> interrupt is returned. Setting this bit to 1 promotes the <b>BEIM</b> interrupt to the interrupt controller.
8	PEIM	R/W	0	UART Parity Error Interrupt Mask On a read, the current mask for the <b>PEIM</b> interrupt is returned. Setting this bit to 1 promotes the <b>PEIM</b> interrupt to the interrupt controller.
7	FEIM	R/W	0	UART Framing Error Interrupt Mask On a read, the current mask for the <b>FEIM</b> interrupt is returned. Setting this bit to 1 promotes the <b>FEIM</b> interrupt to the interrupt controller.
6	RTIM	R/W	0	UART Receive Time-Out Interrupt Mask On a read, the current mask for the <b>RTIM</b> interrupt is returned. Setting this bit to 1 promotes the <b>RTIM</b> interrupt to the interrupt controller.
5	TXIM	R/W	0	UART Transmit Interrupt Mask On a read, the current mask for the <b>TXIM</b> interrupt is returned. Setting this bit to 1 promotes the <b>TXIM</b> interrupt to the interrupt controller.

Bit/Field	Name	Type	Reset	Description
4	RXIM	R/W	0	UART Receive Interrupt Mask On a read, the current mask for the <code>RXIM</code> interrupt is returned. Setting this bit to 1 promotes the <code>RXIM</code> interrupt to the interrupt controller.
3:0	reserved	RO	0x00	Software should not rely on the value of a reserved bit. To provide compatibility with future products, the value of a reserved bit should be preserved across a read-modify-write operation.

## Register 11: UART Raw Interrupt Status (UARTRIS), offset 0x03C

The **UARTRIS** register is the raw interrupt status register. On a read, this register gives the current raw status value of the corresponding interrupt. A write has no effect.

### UART Raw Interrupt Status (UARTRIS)

UART0 base: 0x4000.C000  
 UART1 base: 0x4000.D000  
 UART2 base: 0x4000.E000  
 Offset 0x03C  
 Type RO, reset 0x0000.000F

	31	30	29	28	27	26	25	24	23	22	21	20	19	18	17	16
	reserved															
Type	RO	RO	RO	RO	RO	RO	RO	RO	RO	RO	RO	RO	RO	RO	RO	RO
Reset	0	0	0	0	0	0	0	0	0	0	0	0	0	0	0	0
	15	14	13	12	11	10	9	8	7	6	5	4	3	2	1	0
	reserved						OERIS	BERIS	PERIS	FERIS	RTRIS	TXRIS	RXRIS	reserved		
Type	RO	RO	RO	RO	RO	RO	RO	RO	RO	RO	RO	RO	RO	RO	RO	RO
Reset	0	0	0	0	0	0	0	0	0	0	0	0	0	1	1	1

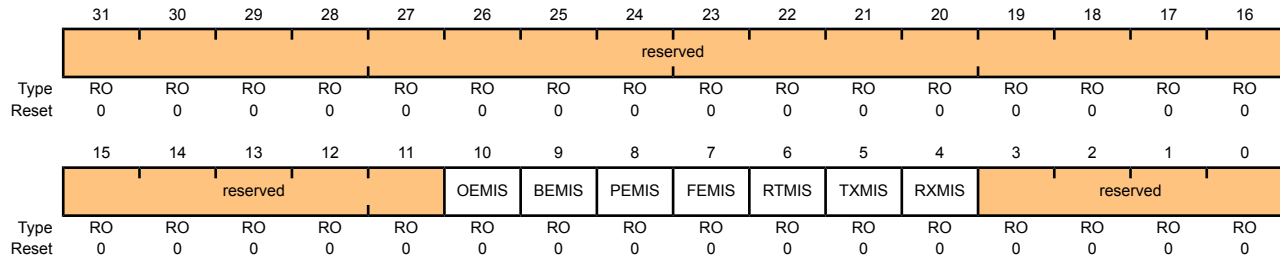
Bit/Field	Name	Type	Reset	Description
31:11	reserved	RO	0x00	Software should not rely on the value of a reserved bit. To provide compatibility with future products, the value of a reserved bit should be preserved across a read-modify-write operation.
10	OERIS	RO	0	UART Overrun Error Raw Interrupt Status Gives the raw interrupt state (prior to masking) of this interrupt.
9	BERIS	RO	0	UART Break Error Raw Interrupt Status Gives the raw interrupt state (prior to masking) of this interrupt.
8	PERIS	RO	0	UART Parity Error Raw Interrupt Status Gives the raw interrupt state (prior to masking) of this interrupt.
7	FERIS	RO	0	UART Framing Error Raw Interrupt Status Gives the raw interrupt state (prior to masking) of this interrupt.
6	RTRIS	RO	0	UART Receive Time-Out Raw Interrupt Status Gives the raw interrupt state (prior to masking) of this interrupt.
5	TXRIS	RO	0	UART Transmit Raw Interrupt Status Gives the raw interrupt state (prior to masking) of this interrupt.
4	RXRIS	RO	0	UART Receive Raw Interrupt Status Gives the raw interrupt state (prior to masking) of this interrupt.
3:0	reserved	RO	0xF	Software should not rely on the value of a reserved bit. To provide compatibility with future products, the value of a reserved bit should be preserved across a read-modify-write operation.

### Register 12: UART Masked Interrupt Status (UARTMIS), offset 0x040

The **UARTMIS** register is the masked interrupt status register. On a read, this register gives the current masked status value of the corresponding interrupt. A write has no effect.

#### UART Masked Interrupt Status (UARTMIS)

UART0 base: 0x4000.C000  
 UART1 base: 0x4000.D000  
 UART2 base: 0x4000.E000  
 Offset 0x040  
 Type RO, reset 0x0000.0000



Bit/Field	Name	Type	Reset	Description
31:11	reserved	RO	0x00	Software should not rely on the value of a reserved bit. To provide compatibility with future products, the value of a reserved bit should be preserved across a read-modify-write operation.
10	OEMIS	RO	0	UART Overrun Error Masked Interrupt Status Gives the masked interrupt state of this interrupt.
9	BEMIS	RO	0	UART Break Error Masked Interrupt Status Gives the masked interrupt state of this interrupt.
8	PEMIS	RO	0	UART Parity Error Masked Interrupt Status Gives the masked interrupt state of this interrupt.
7	FEMIS	RO	0	UART Framing Error Masked Interrupt Status Gives the masked interrupt state of this interrupt.
6	RTMIS	RO	0	UART Receive Time-Out Masked Interrupt Status Gives the masked interrupt state of this interrupt.
5	TXMIS	RO	0	UART Transmit Masked Interrupt Status Gives the masked interrupt state of this interrupt.
4	RXMIS	RO	0	UART Receive Masked Interrupt Status Gives the masked interrupt state of this interrupt.
3:0	reserved	RO	0	Software should not rely on the value of a reserved bit. To provide compatibility with future products, the value of a reserved bit should be preserved across a read-modify-write operation.

## Register 13: UART Interrupt Clear (UARTICR), offset 0x044

The **UARTICR** register is the interrupt clear register. On a write of 1, the corresponding interrupt (both raw interrupt and masked interrupt, if enabled) is cleared. A write of 0 has no effect.

### UART Interrupt Clear (UARTICR)

UART0 base: 0x4000.C000  
 UART1 base: 0x4000.D000  
 UART2 base: 0x4000.E000  
 Offset 0x044  
 Type W1C, reset 0x0000.0000

	31	30	29	28	27	26	25	24	23	22	21	20	19	18	17	16
	reserved															
Type	RO	RO	RO	RO	RO	RO	RO	RO	RO	RO	RO	RO	RO	RO	RO	RO
Reset	0	0	0	0	0	0	0	0	0	0	0	0	0	0	0	0
	15	14	13	12	11	10	9	8	7	6	5	4	3	2	1	0
	reserved					OEIC	BEIC	PEIC	FEIC	RTIC	TXIC	RXIC	reserved			
Type	RO	RO	RO	RO	RO	W1C	W1C	W1C	W1C	W1C	W1C	W1C	RO	RO	RO	RO
Reset	0	0	0	0	0	0	0	0	0	0	0	0	0	0	0	0

Bit/Field	Name	Type	Reset	Description
31:11	reserved	RO	0x00	Software should not rely on the value of a reserved bit. To provide compatibility with future products, the value of a reserved bit should be preserved across a read-modify-write operation.
10	OEIC	W1C	0	Overrun Error Interrupt Clear The <b>OEIC</b> values are defined as follows:  Value Description 0 No effect on the interrupt. 1 Clears interrupt.
9	BEIC	W1C	0	Break Error Interrupt Clear The <b>BEIC</b> values are defined as follows:  Value Description 0 No effect on the interrupt. 1 Clears interrupt.
8	PEIC	W1C	0	Parity Error Interrupt Clear The <b>PEIC</b> values are defined as follows:  Value Description 0 No effect on the interrupt. 1 Clears interrupt.

Bit/Field	Name	Type	Reset	Description
7	FEIC	W1C	0	Framing Error Interrupt Clear The FEIC values are defined as follows:  Value Description 0 No effect on the interrupt. 1 Clears interrupt.
6	RTIC	W1C	0	Receive Time-Out Interrupt Clear The RTIC values are defined as follows:  Value Description 0 No effect on the interrupt. 1 Clears interrupt.
5	TXIC	W1C	0	Transmit Interrupt Clear The TXIC values are defined as follows:  Value Description 0 No effect on the interrupt. 1 Clears interrupt.
4	RXIC	W1C	0	Receive Interrupt Clear The RXIC values are defined as follows:  Value Description 0 No effect on the interrupt. 1 Clears interrupt.
3:0	reserved	RO	0x00	Software should not rely on the value of a reserved bit. To provide compatibility with future products, the value of a reserved bit should be preserved across a read-modify-write operation.

**Register 14: UART Peripheral Identification 4 (UARTPeriphID4), offset 0xFD0**

The **UARTPeriphIDn** registers are hard-coded and the fields within the registers determine the reset values.

## UART Peripheral Identification 4 (UARTPeriphID4)

UART0 base: 0x4000.C000

UART1 base: 0x4000.D000

UART2 base: 0x4000.E000

Offset 0xFD0

Type RO, reset 0x0000.0000

	31	30	29	28	27	26	25	24	23	22	21	20	19	18	17	16
	reserved															
Type	RO	RO	RO	RO	RO	RO	RO	RO	RO	RO	RO	RO	RO	RO	RO	RO
Reset	0	0	0	0	0	0	0	0	0	0	0	0	0	0	0	0
	15	14	13	12	11	10	9	8	7	6	5	4	3	2	1	0
	reserved								PID4							
Type	RO	RO	RO	RO	RO	RO	RO	RO	RO	RO	RO	RO	RO	RO	RO	RO
Reset	0	0	0	0	0	0	0	0	0	0	0	0	0	0	0	0

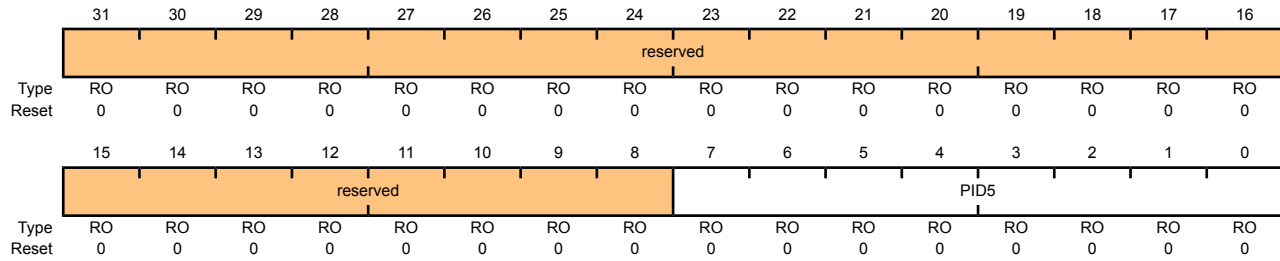
Bit/Field	Name	Type	Reset	Description
31:8	reserved	RO	0x00	Software should not rely on the value of a reserved bit. To provide compatibility with future products, the value of a reserved bit should be preserved across a read-modify-write operation.
7:0	PID4	RO	0x0000	UART Peripheral ID Register[7:0] Can be used by software to identify the presence of this peripheral.

### Register 15: UART Peripheral Identification 5 (UARTPeriphID5), offset 0xFD4

The **UARTPeriphIDn** registers are hard-coded and the fields within the registers determine the reset values.

#### UART Peripheral Identification 5 (UARTPeriphID5)

UART0 base: 0x4000.C000  
 UART1 base: 0x4000.D000  
 UART2 base: 0x4000.E000  
 Offset 0xFD4  
 Type RO, reset 0x0000.0000



Bit/Field	Name	Type	Reset	Description
31:8	reserved	RO	0x00	Software should not rely on the value of a reserved bit. To provide compatibility with future products, the value of a reserved bit should be preserved across a read-modify-write operation.
7:0	PID5	RO	0x0000	UART Peripheral ID Register[15:8]  Can be used by software to identify the presence of this peripheral.



## Register 16: UART Peripheral Identification 6 (UARTPeriphID6), offset 0xFD8

The **UARTPeriphIDn** registers are hard-coded and the fields within the registers determine the reset values.

### UART Peripheral Identification 6 (UARTPeriphID6)

UART0 base: 0x4000.C000  
 UART1 base: 0x4000.D000  
 UART2 base: 0x4000.E000  
 Offset 0xFD8  
 Type RO, reset 0x0000.0000

	31	30	29	28	27	26	25	24	23	22	21	20	19	18	17	16
	reserved															
Type	RO	RO	RO	RO	RO	RO	RO	RO	RO	RO	RO	RO	RO	RO	RO	RO
Reset	0	0	0	0	0	0	0	0	0	0	0	0	0	0	0	0
	15	14	13	12	11	10	9	8	7	6	5	4	3	2	1	0
	reserved								PID6							
Type	RO	RO	RO	RO	RO	RO	RO	RO	RO	RO	RO	RO	RO	RO	RO	RO
Reset	0	0	0	0	0	0	0	0	0	0	0	0	0	0	0	0

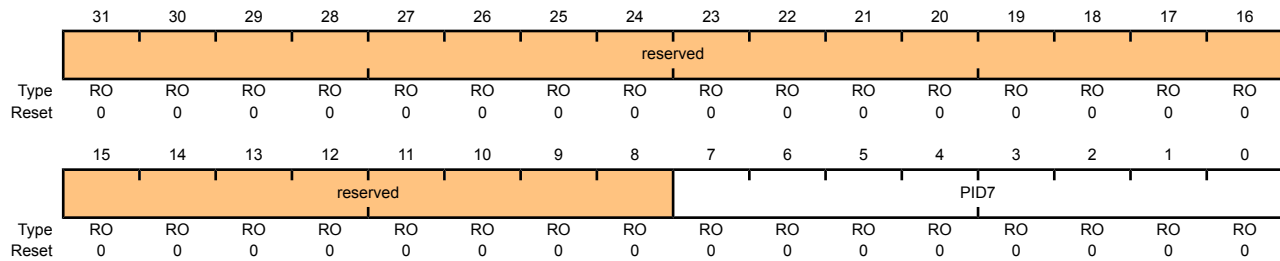
Bit/Field	Name	Type	Reset	Description
31:8	reserved	RO	0x00	Software should not rely on the value of a reserved bit. To provide compatibility with future products, the value of a reserved bit should be preserved across a read-modify-write operation.
7:0	PID6	RO	0x0000	UART Peripheral ID Register[23:16]  Can be used by software to identify the presence of this peripheral.

### Register 17: UART Peripheral Identification 7 (UARTPeriphID7), offset 0xFDC

The **UARTPeriphIDn** registers are hard-coded and the fields within the registers determine the reset values.

#### UART Peripheral Identification 7 (UARTPeriphID7)

UART0 base: 0x4000.C000  
 UART1 base: 0x4000.D000  
 UART2 base: 0x4000.E000  
 Offset 0xFDC  
 Type RO, reset 0x0000.0000



Bit/Field	Name	Type	Reset	Description
31:8	reserved	RO	0	Software should not rely on the value of a reserved bit. To provide compatibility with future products, the value of a reserved bit should be preserved across a read-modify-write operation.
7:0	PID7	RO	0x0000	UART Peripheral ID Register[31:24]  Can be used by software to identify the presence of this peripheral.

**Register 18: UART Peripheral Identification 0 (UARTPeriphID0), offset 0xFE0**

The **UARTPeriphIDn** registers are hard-coded and the fields within the registers determine the reset values.

## UART Peripheral Identification 0 (UARTPeriphID0)

UART0 base: 0x4000.C000  
 UART1 base: 0x4000.D000  
 UART2 base: 0x4000.E000  
 Offset 0xFE0  
 Type RO, reset 0x0000.0011

	31	30	29	28	27	26	25	24	23	22	21	20	19	18	17	16
	reserved															
Type	RO	RO	RO	RO	RO	RO	RO	RO	RO	RO	RO	RO	RO	RO	RO	RO
Reset	0	0	0	0	0	0	0	0	0	0	0	0	0	0	0	0
	15	14	13	12	11	10	9	8	7	6	5	4	3	2	1	0
	reserved								PID0							
Type	RO	RO	RO	RO	RO	RO	RO	RO	RO	RO	RO	RO	RO	RO	RO	RO
Reset	0	0	0	0	0	0	0	0	0	0	0	1	0	0	0	1

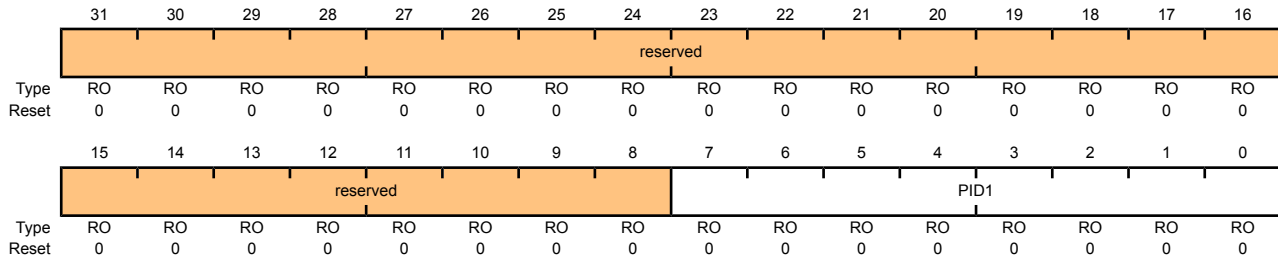
Bit/Field	Name	Type	Reset	Description
31:8	reserved	RO	0x00	Software should not rely on the value of a reserved bit. To provide compatibility with future products, the value of a reserved bit should be preserved across a read-modify-write operation.
7:0	PID0	RO	0x11	UART Peripheral ID Register[7:0]  Can be used by software to identify the presence of this peripheral.

### Register 19: UART Peripheral Identification 1 (UARTPeriphID1), offset 0xFE4

The **UARTPeriphIDn** registers are hard-coded and the fields within the registers determine the reset values.

#### UART Peripheral Identification 1 (UARTPeriphID1)

UART0 base: 0x4000.C000  
 UART1 base: 0x4000.D000  
 UART2 base: 0x4000.E000  
 Offset 0xFE4  
 Type RO, reset 0x0000.0000



Bit/Field	Name	Type	Reset	Description
31:8	reserved	RO	0x00	Software should not rely on the value of a reserved bit. To provide compatibility with future products, the value of a reserved bit should be preserved across a read-modify-write operation.
7:0	PID1	RO	0x00	UART Peripheral ID Register[15:8]  Can be used by software to identify the presence of this peripheral.

**Register 20: UART Peripheral Identification 2 (UARTPeriphID2), offset 0xFE8**

The **UARTPeriphIDn** registers are hard-coded and the fields within the registers determine the reset values.

## UART Peripheral Identification 2 (UARTPeriphID2)

UART0 base: 0x4000.C000

UART1 base: 0x4000.D000

UART2 base: 0x4000.E000

Offset 0xFE8

Type RO, reset 0x0000.0018

	31	30	29	28	27	26	25	24	23	22	21	20	19	18	17	16
	reserved															
Type	RO	RO	RO	RO	RO	RO	RO	RO	RO	RO	RO	RO	RO	RO	RO	RO
Reset	0	0	0	0	0	0	0	0	0	0	0	0	0	0	0	0
	15	14	13	12	11	10	9	8	7	6	5	4	3	2	1	0
	reserved								PID2							
Type	RO	RO	RO	RO	RO	RO	RO	RO	RO	RO	RO	RO	RO	RO	RO	RO
Reset	0	0	0	0	0	0	0	0	0	0	0	1	1	0	0	0

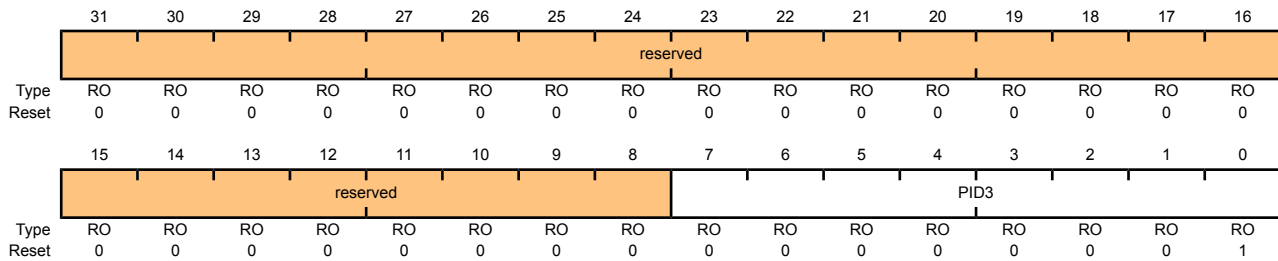
Bit/Field	Name	Type	Reset	Description
31:8	reserved	RO	0x00	Software should not rely on the value of a reserved bit. To provide compatibility with future products, the value of a reserved bit should be preserved across a read-modify-write operation.
7:0	PID2	RO	0x18	UART Peripheral ID Register[23:16] Can be used by software to identify the presence of this peripheral.

### Register 21: UART Peripheral Identification 3 (UARTPeriphID3), offset 0xFEC

The **UARTPeriphIDn** registers are hard-coded and the fields within the registers determine the reset values.

#### UART Peripheral Identification 3 (UARTPeriphID3)

UART0 base: 0x4000.C000  
 UART1 base: 0x4000.D000  
 UART2 base: 0x4000.E000  
 Offset 0xFEC  
 Type RO, reset 0x0000.0001



Bit/Field	Name	Type	Reset	Description
31:8	reserved	RO	0x00	Software should not rely on the value of a reserved bit. To provide compatibility with future products, the value of a reserved bit should be preserved across a read-modify-write operation.
7:0	PID3	RO	0x01	UART Peripheral ID Register[31:24]  Can be used by software to identify the presence of this peripheral.

**Register 22: UART PrimeCell Identification 0 (UARTPCellID0), offset 0xFF0**

The **UARTPCellIDn** registers are hard-coded and the fields within the registers determine the reset values.

## UART PrimeCell Identification 0 (UARTPCellID0)

UART0 base: 0x4000.C000  
 UART1 base: 0x4000.D000  
 UART2 base: 0x4000.E000  
 Offset 0xFF0  
 Type RO, reset 0x0000.000D

	31	30	29	28	27	26	25	24	23	22	21	20	19	18	17	16
	reserved															
Type	RO	RO	RO	RO	RO	RO	RO	RO	RO	RO	RO	RO	RO	RO	RO	RO
Reset	0	0	0	0	0	0	0	0	0	0	0	0	0	0	0	0
	15	14	13	12	11	10	9	8	7	6	5	4	3	2	1	0
	reserved								CID0							
Type	RO	RO	RO	RO	RO	RO	RO	RO	RO	RO	RO	RO	RO	RO	RO	RO
Reset	0	0	0	0	0	0	0	0	0	0	0	0	1	1	0	1

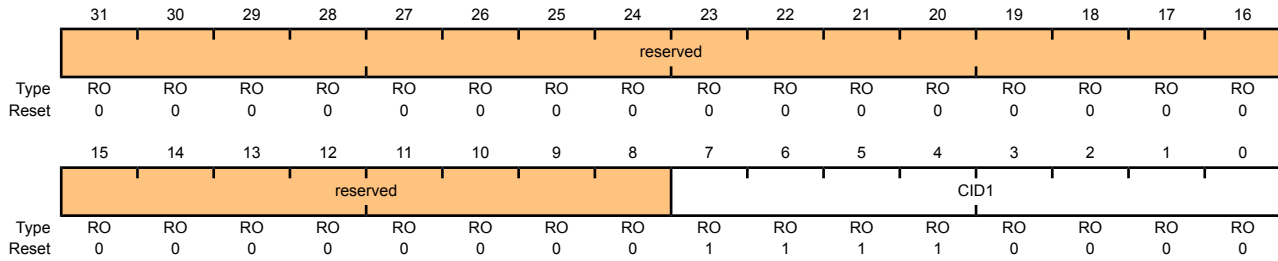
Bit/Field	Name	Type	Reset	Description
31:8	reserved	RO	0x00	Software should not rely on the value of a reserved bit. To provide compatibility with future products, the value of a reserved bit should be preserved across a read-modify-write operation.
7:0	CID0	RO	0x0D	UART PrimeCell ID Register[7:0] Provides software a standard cross-peripheral identification system.

### Register 23: UART PrimeCell Identification 1 (UARTPCellID1), offset 0xFF4

The **UARTPCellIDn** registers are hard-coded and the fields within the registers determine the reset values.

#### UART PrimeCell Identification 1 (UARTPCellID1)

UART0 base: 0x4000.C000  
 UART1 base: 0x4000.D000  
 UART2 base: 0x4000.E000  
 Offset 0xFF4  
 Type RO, reset 0x0000.00F0



Bit/Field	Name	Type	Reset	Description
31:8	reserved	RO	0x00	Software should not rely on the value of a reserved bit. To provide compatibility with future products, the value of a reserved bit should be preserved across a read-modify-write operation.
7:0	CID1	RO	0xF0	UART PrimeCell ID Register[15:8] Provides software a standard cross-peripheral identification system.



**Register 24: UART PrimeCell Identification 2 (UARTPCelIID2), offset 0xFF8**

The **UARTPCelIIDn** registers are hard-coded and the fields within the registers determine the reset values.

## UART PrimeCell Identification 2 (UARTPCelIID2)

UART0 base: 0x4000.C000

UART1 base: 0x4000.D000

UART2 base: 0x4000.E000

Offset 0xFF8

Type RO, reset 0x0000.0005

	31	30	29	28	27	26	25	24	23	22	21	20	19	18	17	16
	reserved															
Type	RO	RO	RO	RO	RO	RO	RO	RO	RO	RO	RO	RO	RO	RO	RO	RO
Reset	0	0	0	0	0	0	0	0	0	0	0	0	0	0	0	0
	15	14	13	12	11	10	9	8	7	6	5	4	3	2	1	0
	reserved								CID2							
Type	RO	RO	RO	RO	RO	RO	RO	RO	RO	RO	RO	RO	RO	RO	RO	RO
Reset	0	0	0	0	0	0	0	0	0	0	0	0	0	1	0	1

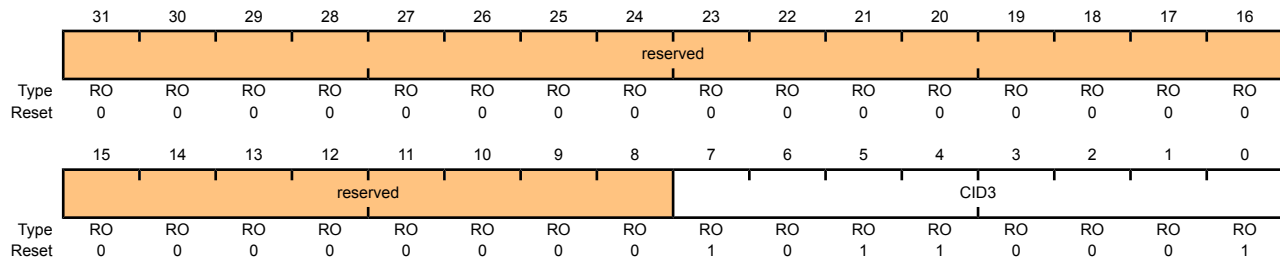
Bit/Field	Name	Type	Reset	Description
31:8	reserved	RO	0x00	Software should not rely on the value of a reserved bit. To provide compatibility with future products, the value of a reserved bit should be preserved across a read-modify-write operation.
7:0	CID2	RO	0x05	UART PrimeCell ID Register[23:16] Provides software a standard cross-peripheral identification system.

### Register 25: UART PrimeCell Identification 3 (UARTPCelIID3), offset 0xFFC

The **UARTPCelIIDn** registers are hard-coded and the fields within the registers determine the reset values.

#### UART PrimeCell Identification 3 (UARTPCelIID3)

UART0 base: 0x4000.C000  
 UART1 base: 0x4000.D000  
 UART2 base: 0x4000.E000  
 Offset 0xFFC  
 Type RO, reset 0x0000.00B1



Bit/Field	Name	Type	Reset	Description
31:8	reserved	RO	0x00	Software should not rely on the value of a reserved bit. To provide compatibility with future products, the value of a reserved bit should be preserved across a read-modify-write operation.
7:0	CID3	RO	0xB1	UART PrimeCell ID Register[31:24] Provides software a standard cross-peripheral identification system.

## 14 Synchronous Serial Interface (SSI)

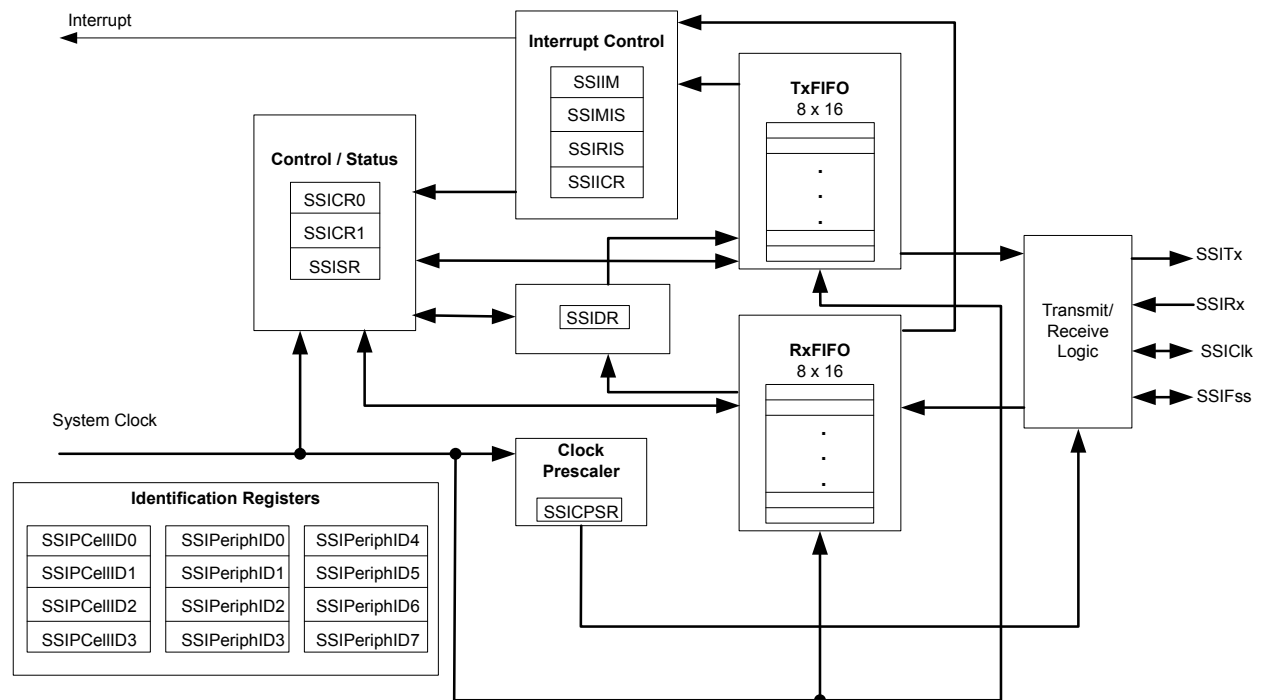
The Stellaris<sup>®</sup> microcontroller includes two Synchronous Serial Interface (SSI) modules. Each SSI is a master or slave interface for synchronous serial communication with peripheral devices that have either Freescale SPI, MICROWIRE, or Texas Instruments synchronous serial interfaces.

Each Stellaris<sup>®</sup> SSI module has the following features:

- Master or slave operation
- Programmable clock bit rate and prescale
- Separate transmit and receive FIFOs, 16 bits wide, 8 locations deep
- Programmable interface operation for Freescale SPI, MICROWIRE, or Texas Instruments synchronous serial interfaces
- Programmable data frame size from 4 to 16 bits
- Internal loopback test mode for diagnostic/debug testing

### 14.1 Block Diagram

Figure 14-1. SSI Module Block Diagram



### 14.2 Functional Description

The SSI performs serial-to-parallel conversion on data received from a peripheral device. The CPU accesses data, control, and status information. The transmit and receive paths are buffered with

internal FIFO memories allowing up to eight 16-bit values to be stored independently in both transmit and receive modes.

### 14.2.1 Bit Rate Generation

The SSI includes a programmable bit rate clock divider and prescaler to generate the serial output clock. Bit rates are supported to 2 MHz and higher, although maximum bit rate is determined by peripheral devices.

The serial bit rate is derived by dividing down the 50-MHz input clock. The clock is first divided by an even prescale value `CPSDVSR` from 2 to 254, which is programmed in the **SSI Clock Prescale (SSICPSR)** register (see page 350). The clock is further divided by a value from 1 to 256, which is  $1 + SCR$ , where `SCR` is the value programmed in the **SSI Control0 (SSICR0)** register (see page 343).

The frequency of the output clock `SSIClk` is defined by:

$$f_{SSIClk} = f_{SysClk} / (CPSDVSR * (1 + SCR))$$

Note that although the `SSIClk` transmit clock can theoretically be 25 MHz, the module may not be able to operate at that speed. For master mode, the system clock must be at least two times faster than the `SSIClk`. For slave mode, the system clock must be at least 12 times faster than the `SSIClk`.

See “Synchronous Serial Interface (SSI)” on page 437 to view SSI timing parameters.

### 14.2.2 FIFO Operation

#### 14.2.2.1 Transmit FIFO

The common transmit FIFO is a 16-bit wide, 8-locations deep, first-in, first-out memory buffer. The CPU writes data to the FIFO by writing the **SSI Data (SSIDR)** register (see page 347), and data is stored in the FIFO until it is read out by the transmission logic.

When configured as a master or a slave, parallel data is written into the transmit FIFO prior to serial conversion and transmission to the attached slave or master, respectively, through the `SSITx` pin.

#### 14.2.2.2 Receive FIFO

The common receive FIFO is a 16-bit wide, 8-locations deep, first-in, first-out memory buffer. Received data from the serial interface is stored in the buffer until read out by the CPU, which accesses the read FIFO by reading the **SSIDR** register.

When configured as a master or slave, serial data received through the `SSIRx` pin is registered prior to parallel loading into the attached slave or master receive FIFO, respectively.

### 14.2.3 Interrupts

The SSI can generate interrupts when the following conditions are observed:

- Transmit FIFO service
- Receive FIFO service
- Receive FIFO time-out
- Receive FIFO overrun

All of the interrupt events are ORed together before being sent to the interrupt controller, so the SSI can only generate a single interrupt request to the controller at any given time. You can mask each

of the four individual maskable interrupts by setting the appropriate bits in the **SSI Interrupt Mask (SSIIM)** register (see page 351). Setting the appropriate mask bit to 1 enables the interrupt.

Provision of the individual outputs, as well as a combined interrupt output, allows use of either a global interrupt service routine, or modular device drivers to handle interrupts. The transmit and receive dynamic dataflow interrupts have been separated from the status interrupts so that data can be read or written in response to the FIFO trigger levels. The status of the individual interrupt sources can be read from the **SSI Raw Interrupt Status (SSIRIS)** and **SSI Masked Interrupt Status (SSIMIS)** registers (see page 353 and page 354, respectively).

## 14.2.4 Frame Formats

Each data frame is between 4 and 16 bits long, depending on the size of data programmed, and is transmitted starting with the MSB. There are three basic frame types that can be selected:

- Texas Instruments synchronous serial
- Freescale SPI
- MICROWIRE

For all three formats, the serial clock ( $SSIClk$ ) is held inactive while the SSI is idle, and  $SSIClk$  transitions at the programmed frequency only during active transmission or reception of data. The idle state of  $SSIClk$  is utilized to provide a receive timeout indication that occurs when the receive FIFO still contains data after a timeout period.

For Freescale SPI and MICROWIRE frame formats, the serial frame ( $SSIFss$ ) pin is active Low, and is asserted (pulled down) during the entire transmission of the frame.

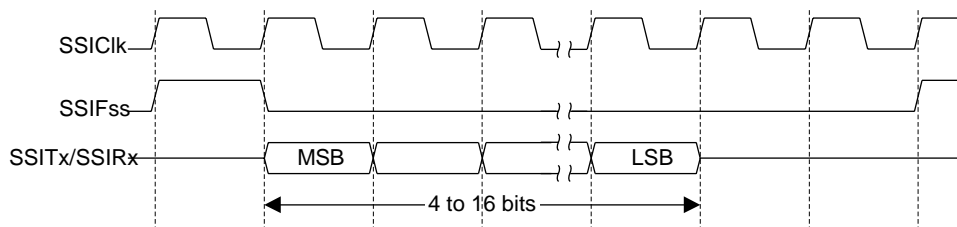
For Texas Instruments synchronous serial frame format, the  $SSIFss$  pin is pulsed for one serial clock period starting at its rising edge, prior to the transmission of each frame. For this frame format, both the SSI and the off-chip slave device drive their output data on the rising edge of  $SSIClk$ , and latch data from the other device on the falling edge.

Unlike the full-duplex transmission of the other two frame formats, the MICROWIRE format uses a special master-slave messaging technique, which operates at half-duplex. In this mode, when a frame begins, an 8-bit control message is transmitted to the off-chip slave. During this transmit, no incoming data is received by the SSI. After the message has been sent, the off-chip slave decodes it and, after waiting one serial clock after the last bit of the 8-bit control message has been sent, responds with the requested data. The returned data can be 4 to 16 bits in length, making the total frame length anywhere from 13 to 25 bits.

### 14.2.4.1 Texas Instruments Synchronous Serial Frame Format

Figure 14-2 on page 333 shows the Texas Instruments synchronous serial frame format for a single transmitted frame.

**Figure 14-2. TI Synchronous Serial Frame Format (Single Transfer)**

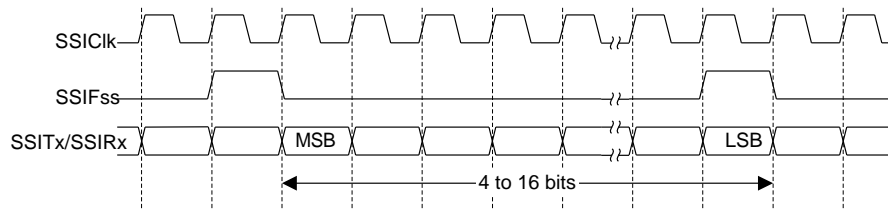


In this mode,  $SSIClk$  and  $SSIFss$  are forced Low, and the transmit data line  $SSITx$  is tristated whenever the SSI is idle. Once the bottom entry of the transmit FIFO contains data,  $SSIFss$  is pulsed High for one  $SSIClk$  period. The value to be transmitted is also transferred from the transmit FIFO to the serial shift register of the transmit logic. On the next rising edge of  $SSIClk$ , the MSB of the 4 to 16-bit data frame is shifted out on the  $SSITx$  pin. Likewise, the MSB of the received data is shifted onto the  $SSIRx$  pin by the off-chip serial slave device.

Both the SSI and the off-chip serial slave device then clock each data bit into their serial shifter on the falling edge of each  $SSIClk$ . The received data is transferred from the serial shifter to the receive FIFO on the first rising edge of  $SSIClk$  after the LSB has been latched.

Figure 14-3 on page 334 shows the Texas Instruments synchronous serial frame format when back-to-back frames are transmitted.

**Figure 14-3. TI Synchronous Serial Frame Format (Continuous Transfer)**



#### 14.2.4.2 Freescale SPI Frame Format

The Freescale SPI interface is a four-wire interface where the  $SSIFss$  signal behaves as a slave select. The main feature of the Freescale SPI format is that the inactive state and phase of the  $SSIClk$  signal are programmable through the  $SPO$  and  $SPH$  bits within the **SSISCR0** control register.

##### **SPO Clock Polarity Bit**

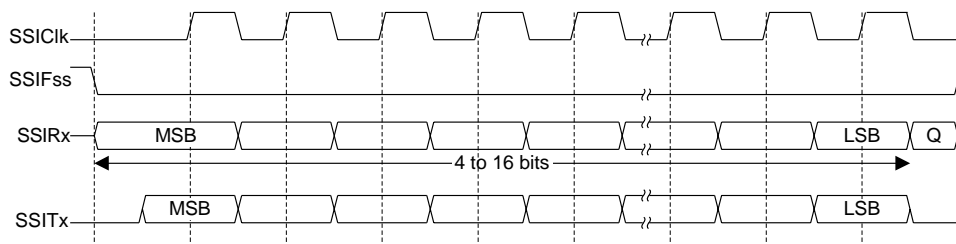
When the  $SPO$  clock polarity control bit is Low, it produces a steady state Low value on the  $SSIClk$  pin. If the  $SPO$  bit is High, a steady state High value is placed on the  $SSIClk$  pin when data is not being transferred.

##### **SPH Phase Control Bit**

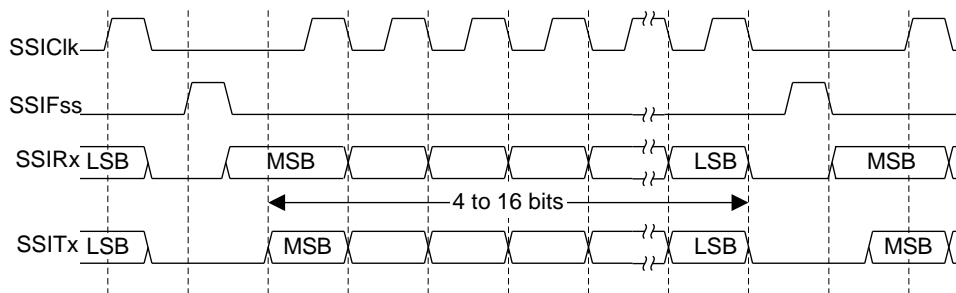
The  $SPH$  phase control bit selects the clock edge that captures data and allows it to change state. It has the most impact on the first bit transmitted by either allowing or not allowing a clock transition before the first data capture edge. When the  $SPH$  phase control bit is Low, data is captured on the first clock edge transition. If the  $SPH$  bit is High, data is captured on the second clock edge transition.

#### 14.2.4.3 Freescale SPI Frame Format with $SPO=0$ and $SPH=0$

Single and continuous transmission signal sequences for Freescale SPI format with  $SPO=0$  and  $SPH=0$  are shown in Figure 14-4 on page 335 and Figure 14-5 on page 335.

**Figure 14-4. Freescale SPI Format (Single Transfer) with SPO=0 and SPH=0**

**Note:** Q is undefined.

**Figure 14-5. Freescale SPI Format (Continuous Transfer) with SPO=0 and SPH=0**

In this configuration, during idle periods:

- SSIClk is forced Low
- SSIFss is forced High
- The transmit data line SSITx is arbitrarily forced Low
- When the SSI is configured as a master, it enables the SSIClk pad
- When the SSI is configured as a slave, it disables the SSIClk pad

If the SSI is enabled and there is valid data within the transmit FIFO, the start of transmission is signified by the SSIFss master signal being driven Low. This causes slave data to be enabled onto the SSIRx input line of the master. The master SSITx output pad is enabled.

One half SSIClk period later, valid master data is transferred to the SSITx pin. Now that both the master and slave data have been set, the SSIClk master clock pin goes High after one further half SSIClk period.

The data is now captured on the rising and propagated on the falling edges of the SSIClk signal.

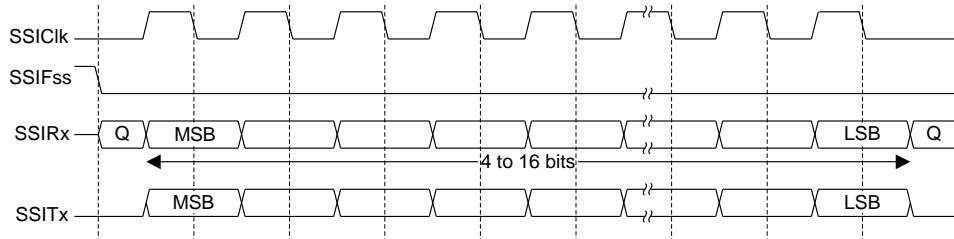
In the case of a single word transmission, after all bits of the data word have been transferred, the SSIFss line is returned to its idle High state one SSIClk period after the last bit has been captured.

However, in the case of continuous back-to-back transmissions, the SSIFss signal must be pulsed High between each data word transfer. This is because the slave select pin freezes the data in its serial peripheral register and does not allow it to be altered if the SPH bit is logic zero. Therefore, the master device must raise the SSIFss pin of the slave device between each data transfer to enable the serial peripheral data write. On completion of the continuous transfer, the SSIFss pin is returned to its idle state one SSIClk period after the last bit has been captured.

#### 14.2.4.4 Freescale SPI Frame Format with SPO=0 and SPH=1

The transfer signal sequence for Freescale SPI format with SPO=0 and SPH=1 is shown in Figure 14-6 on page 336, which covers both single and continuous transfers.

**Figure 14-6. Freescale SPI Frame Format with SPO=0 and SPH=1**



**Note:** Q is undefined.

In this configuration, during idle periods:

- SSIClk is forced Low
- SSIFss is forced High
- The transmit data line SSITx is arbitrarily forced Low
- When the SSI is configured as a master, it enables the SSIClk pad
- When the SSI is configured as a slave, it disables the SSIClk pad

If the SSI is enabled and there is valid data within the transmit FIFO, the start of transmission is signified by the SSIFss master signal being driven Low. The master SSITx output is enabled. After a further one half SSIClk period, both master and slave valid data is enabled onto their respective transmission lines. At the same time, the SSIClk is enabled with a rising edge transition.

Data is then captured on the falling edges and propagated on the rising edges of the SSIClk signal.

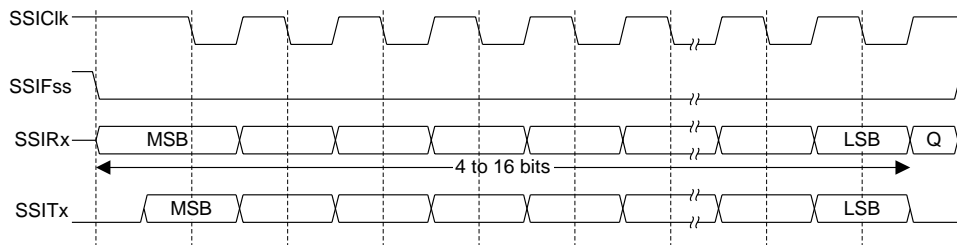
In the case of a single word transfer, after all bits have been transferred, the SSIFss line is returned to its idle High state one SSIClk period after the last bit has been captured.

For continuous back-to-back transfers, the SSIFss pin is held Low between successive data words and termination is the same as that of the single word transfer.

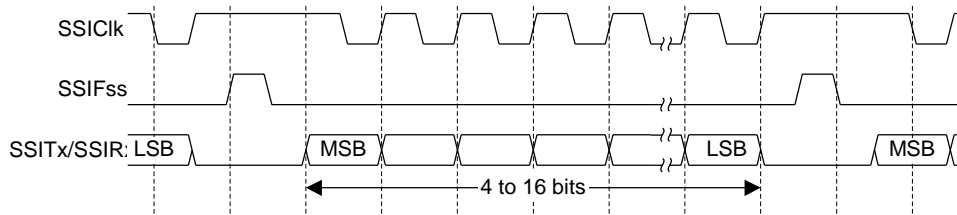
#### 14.2.4.5 Freescale SPI Frame Format with SPO=1 and SPH=0

Single and continuous transmission signal sequences for Freescale SPI format with SPO=1 and SPH=0 are shown in Figure 14-7 on page 337 and Figure 14-8 on page 337.



**Figure 14-7. Freescale SPI Frame Format (Single Transfer) with SPO=1 and SPH=0**

**Note:** Q is undefined.

**Figure 14-8. Freescale SPI Frame Format (Continuous Transfer) with SPO=1 and SPH=0**

In this configuration, during idle periods:

- SSIClk is forced High
- SSIFss is forced High
- The transmit data line SSITx is arbitrarily forced Low
- When the SSI is configured as a master, it enables the SSIClk pad
- When the SSI is configured as a slave, it disables the SSIClk pad

If the SSI is enabled and there is valid data within the transmit FIFO, the start of transmission is signified by the SSIFss master signal being driven Low, which causes slave data to be immediately transferred onto the SSIRx line of the master. The master SSITx output pad is enabled.

One half period later, valid master data is transferred to the SSITx line. Now that both the master and slave data have been set, the SSIClk master clock pin becomes Low after one further half SSIClk period. This means that data is captured on the falling edges and propagated on the rising edges of the SSIClk signal.

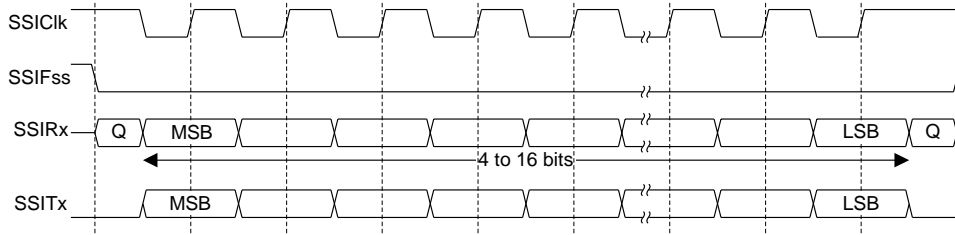
In the case of a single word transmission, after all bits of the data word are transferred, the SSIFss line is returned to its idle High state one SSIClk period after the last bit has been captured.

However, in the case of continuous back-to-back transmissions, the SSIFss signal must be pulsed High between each data word transfer. This is because the slave select pin freezes the data in its serial peripheral register and does not allow it to be altered if the SPH bit is logic zero. Therefore, the master device must raise the SSIFss pin of the slave device between each data transfer to enable the serial peripheral data write. On completion of the continuous transfer, the SSIFss pin is returned to its idle state one SSIClk period after the last bit has been captured.

#### 14.2.4.6 Freescale SPI Frame Format with SPO=1 and SPH=1

The transfer signal sequence for Freescale SPI format with SPO=1 and SPH=1 is shown in Figure 14-9 on page 338, which covers both single and continuous transfers.

**Figure 14-9. Freescale SPI Frame Format with SPO=1 and SPH=1**



**Note:** Q is undefined.

In this configuration, during idle periods:

- SSIClk is forced High
- SSIFss is forced High
- The transmit data line SSITx is arbitrarily forced Low
- When the SSI is configured as a master, it enables the SSIClk pad
- When the SSI is configured as a slave, it disables the SSIClk pad

If the SSI is enabled and there is valid data within the transmit FIFO, the start of transmission is signified by the SSIFss master signal being driven Low. The master SSITx output pad is enabled. After a further one-half SSIClk period, both master and slave data are enabled onto their respective transmission lines. At the same time, SSIClk is enabled with a falling edge transition. Data is then captured on the rising edges and propagated on the falling edges of the SSIClk signal.

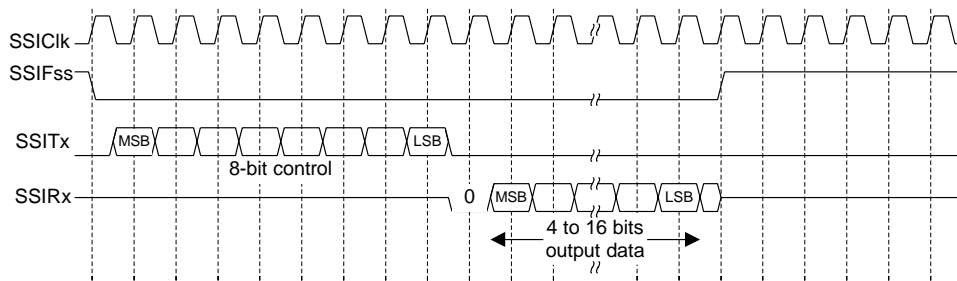
After all bits have been transferred, in the case of a single word transmission, the SSIFss line is returned to its idle high state one SSIClk period after the last bit has been captured.

For continuous back-to-back transmissions, the SSIFss pin remains in its active Low state, until the final bit of the last word has been captured, and then returns to its idle state as described above.

For continuous back-to-back transfers, the SSIFss pin is held Low between successive data words and termination is the same as that of the single word transfer.

#### 14.2.4.7 MICROWIRE Frame Format

Figure 14-10 on page 339 shows the MICROWIRE frame format, again for a single frame. Figure 14-11 on page 340 shows the same format when back-to-back frames are transmitted.

**Figure 14-10. MICROWIRE Frame Format (Single Frame)**

MICROWIRE format is very similar to SPI format, except that transmission is half-duplex instead of full-duplex, using a master-slave message passing technique. Each serial transmission begins with an 8-bit control word that is transmitted from the SSI to the off-chip slave device. During this transmission, no incoming data is received by the SSI. After the message has been sent, the off-chip slave decodes it and, after waiting one serial clock after the last bit of the 8-bit control message has been sent, responds with the required data. The returned data is 4 to 16 bits in length, making the total frame length anywhere from 13 to 25 bits.

In this configuration, during idle periods:

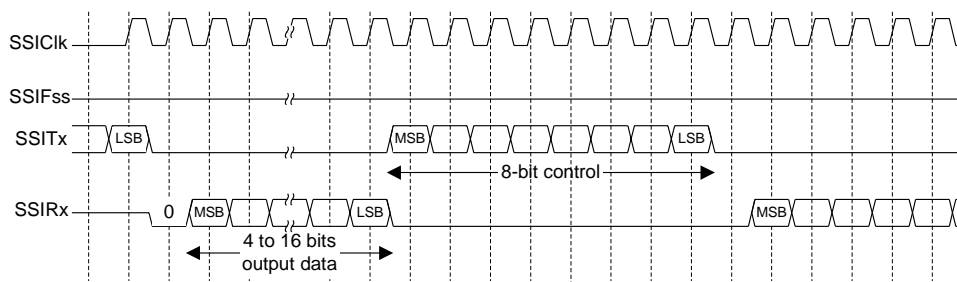
- SSIClk is forced Low
- SSIFss is forced High
- The transmit data line SSITx is arbitrarily forced Low

A transmission is triggered by writing a control byte to the transmit FIFO. The falling edge of SSIFss causes the value contained in the bottom entry of the transmit FIFO to be transferred to the serial shift register of the transmit logic, and the MSB of the 8-bit control frame to be shifted out onto the SSITx pin. SSIFss remains Low for the duration of the frame transmission. The SSIRx pin remains tristated during this transmission.

The off-chip serial slave device latches each control bit into its serial shifter on the rising edge of each SSIClk. After the last bit is latched by the slave device, the control byte is decoded during a one clock wait-state, and the slave responds by transmitting data back to the SSI. Each bit is driven onto the SSIRx line on the falling edge of SSIClk. The SSI in turn latches each bit on the rising edge of SSIClk. At the end of the frame, for single transfers, the SSIFss signal is pulled High one clock period after the last bit has been latched in the receive serial shifter, which causes the data to be transferred to the receive FIFO.

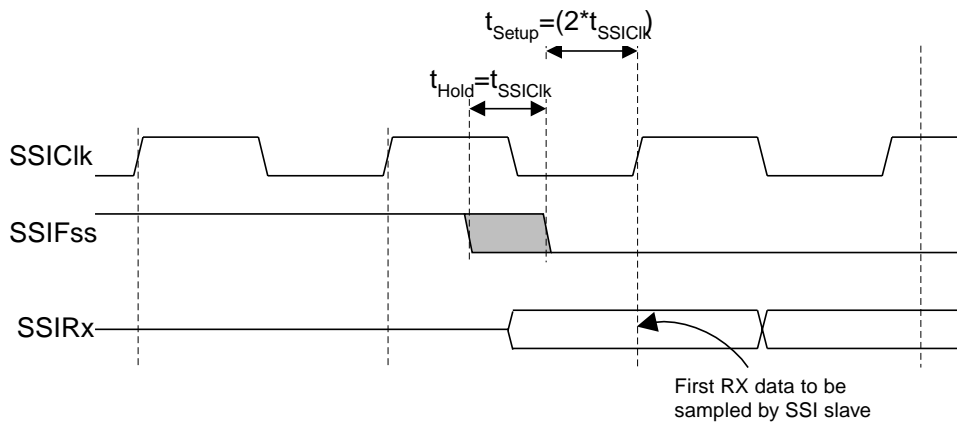
**Note:** The off-chip slave device can tristate the receive line either on the falling edge of SSIClk after the LSB has been latched by the receive shifter, or when the SSIFss pin goes High.

For continuous transfers, data transmission begins and ends in the same manner as a single transfer. However, the SSIFss line is continuously asserted (held Low) and transmission of data occurs back-to-back. The control byte of the next frame follows directly after the LSB of the received data from the current frame. Each of the received values is transferred from the receive shifter on the falling edge of SSIClk, after the LSB of the frame has been latched into the SSI.

**Figure 14-11. MICROWIRE Frame Format (Continuous Transfer)**

In the MICROWIRE mode, the SSI slave samples the first bit of receive data on the rising edge of SSIClk after SSIFss has gone Low. Masters that drive a free-running SSIClk must ensure that the SSIFss signal has sufficient setup and hold margins with respect to the rising edge of SSIClk.

Figure 14-12 on page 340 illustrates these setup and hold time requirements. With respect to the SSIClk rising edge on which the first bit of receive data is to be sampled by the SSI slave, SSIFss must have a setup of at least two times the period of SSIClk on which the SSI operates. With respect to the SSIClk rising edge previous to this edge, SSIFss must have a hold of at least one SSIClk period.

**Figure 14-12. MICROWIRE Frame Format, SSIFss Input Setup and Hold Requirements**

## 14.3 Initialization and Configuration

To use the SSI, its peripheral clock must be enabled by setting the SSI bit in the RCGC1 register.

For each of the frame formats, the SSI is configured using the following steps:

1. Ensure that the SSE bit in the SSICR1 register is disabled before making any configuration changes.
2. Select whether the SSI is a master or slave:
  - a. For master operations, set the SSICR1 register to 0x0000.0000.
  - b. For slave mode (output enabled), set the SSICR1 register to 0x0000.0004.
  - c. For slave mode (output disabled), set the SSICR1 register to 0x0000.000C.
3. Configure the clock prescale divisor by writing the SSICPSR register.

4. Write the **SSICR0** register with the following configuration:
  - Serial clock rate (*SCR*)
  - Desired clock phase/polarity, if using Freescale SPI mode (*SPH* and *SPO*)
  - The protocol mode: Freescale SPI, TI SSF, MICROWIRE (*FRF*)
  - The data size (*DSS*)
5. Enable the SSI by setting the *SSE* bit in the **SSICR1** register.

As an example, assume the SSI must be configured to operate with the following parameters:

- Master operation
- Freescale SPI mode (*SPO*=1, *SPH*=1)
- 1 Mbps bit rate
- 8 data bits

Assuming the system clock is 20 MHz, the bit rate calculation would be:

$$F_{SSIClk} = F_{SysClk} / (CPSDVSR * (1 + SCR))$$

$$1 \times 10^6 = 20 \times 10^6 / (CPSDVSR * (1 + SCR))$$

In this case, if *CPSDVSR*=2, *SCR* must be 9.

The configuration sequence would be as follows:

1. Ensure that the *SSE* bit in the **SSICR1** register is disabled.
2. Write the **SSICR1** register with a value of 0x0000.0000.
3. Write the **SSICPSR** register with a value of 0x0000.0002.
4. Write the **SSICR0** register with a value of 0x0000.09C7.
5. The SSI is then enabled by setting the *SSE* bit in the **SSICR1** register to 1.

## 14.4 Register Map

Table 14-1 on page 342 lists the SSI registers. The offset listed is a hexadecimal increment to the register's address, relative to that SSI module's base address:

- SSI0: 0x4000.8000
- SSI1: 0x4000.9000

**Note:** The SSI must be disabled (see the *SSE* bit in the **SSICR1** register) before any of the control registers are reprogrammed.

Table 14-1. SSI Register Map

Offset	Name	Type	Reset	Description	See page
0x000	SSICR0	R/W	0x0000.0000	SSI Control 0	343
0x004	SSICR1	R/W	0x0000.0000	SSI Control 1	345
0x008	SSIDR	R/W	0x0000.0000	SSI Data	347
0x00C	SSISR	RO	0x0000.0003	SSI Status	348
0x010	SSICPSR	R/W	0x0000.0000	SSI Clock Prescale	350
0x014	SSIIM	R/W	0x0000.0000	SSI Interrupt Mask	351
0x018	SSIRIS	RO	0x0000.0008	SSI Raw Interrupt Status	353
0x01C	SSIMIS	RO	0x0000.0000	SSI Masked Interrupt Status	354
0x020	SSIICR	W1C	0x0000.0000	SSI Interrupt Clear	355
0xFD0	SSIPeriphID4	RO	0x0000.0000	SSI Peripheral Identification 4	356
0xFD4	SSIPeriphID5	RO	0x0000.0000	SSI Peripheral Identification 5	357
0xFD8	SSIPeriphID6	RO	0x0000.0000	SSI Peripheral Identification 6	358
0xFDC	SSIPeriphID7	RO	0x0000.0000	SSI Peripheral Identification 7	359
0xFE0	SSIPeriphID0	RO	0x0000.0022	SSI Peripheral Identification 0	360
0xFE4	SSIPeriphID1	RO	0x0000.0000	SSI Peripheral Identification 1	361
0xFE8	SSIPeriphID2	RO	0x0000.0018	SSI Peripheral Identification 2	362
0xFEC	SSIPeriphID3	RO	0x0000.0001	SSI Peripheral Identification 3	363
0xFF0	SSIPCellIID0	RO	0x0000.000D	SSI PrimeCell Identification 0	364
0xFF4	SSIPCellIID1	RO	0x0000.00F0	SSI PrimeCell Identification 1	365
0xFF8	SSIPCellIID2	RO	0x0000.0005	SSI PrimeCell Identification 2	366
0xFFC	SSIPCellIID3	RO	0x0000.00B1	SSI PrimeCell Identification 3	367

## 14.5 Register Descriptions

The remainder of this section lists and describes the SSI registers, in numerical order by address offset.

## Register 1: SSI Control 0 (SSICR0), offset 0x000

**SSICR0** is control register 0 and contains bit fields that control various functions within the SSI module. Functionality such as protocol mode, clock rate, and data size are configured in this register.

### SSI Control 0 (SSICR0)

SSI0 base: 0x4000.8000  
 SSI1 base: 0x4000.9000  
 Offset 0x000  
 Type R/W, reset 0x0000.0000

	31	30	29	28	27	26	25	24	23	22	21	20	19	18	17	16	
	reserved																
Type	RO	RO	RO	RO	RO	RO	RO	RO	RO	RO	RO	RO	RO	RO	RO	RO	
Reset	0	0	0	0	0	0	0	0	0	0	0	0	0	0	0	0	
	15	14	13	12	11	10	9	8	7	6	5	4	3	2	1	0	
	SCR								SPH	SPO	FRF			DSS			
Type	R/W	R/W	R/W	R/W	R/W	R/W	R/W	R/W	R/W	R/W	R/W	R/W	R/W	R/W	R/W	R/W	
Reset	0	0	0	0	0	0	0	0	0	0	0	0	0	0	0	0	

Bit/Field	Name	Type	Reset	Description
31:16	reserved	RO	0x00	Software should not rely on the value of a reserved bit. To provide compatibility with future products, the value of a reserved bit should be preserved across a read-modify-write operation.
15:8	SCR	R/W	0x0000	SSI Serial Clock Rate  The value <i>SCR</i> is used to generate the transmit and receive bit rate of the SSI. The bit rate is:  $BR = F_{SSIClk} / (CPSDVSr * (1 + SCR))$  where <i>CPSDVSr</i> is an even value from 2-254 programmed in the <b>SSICPSR</b> register, and <i>SCR</i> is a value from 0-255.
7	SPH	R/W	0	SSI Serial Clock Phase  This bit is only applicable to the Freescale SPI Format.  The <i>SPH</i> control bit selects the clock edge that captures data and allows it to change state. It has the most impact on the first bit transmitted by either allowing or not allowing a clock transition before the first data capture edge.  When the <i>SPH</i> bit is 0, data is captured on the first clock edge transition. If <i>SPH</i> is 1, data is captured on the second clock edge transition.
6	SPO	R/W	0	SSI Serial Clock Polarity  This bit is only applicable to the Freescale SPI Format.  When the <i>SPO</i> bit is 0, it produces a steady state Low value on the <i>SSIClk</i> pin. If <i>SPO</i> is 1, a steady state High value is placed on the <i>SSIClk</i> pin when data is not being transferred.

Bit/Field	Name	Type	Reset	Description
5:4	FRF	R/W	0x0	SSI Frame Format Select The FRF values are defined as follows:  Value Frame Format 0x0 Freescale SPI Frame Format 0x1 Texas Instruments Synchronous Serial Frame Format 0x2 MICROWIRE Frame Format 0x3 Reserved
3:0	DSS	R/W	0x00	SSI Data Size Select The DSS values are defined as follows:  Value Data Size 0x0-0x2 Reserved 0x3 4-bit data 0x4 5-bit data 0x5 6-bit data 0x6 7-bit data 0x7 8-bit data 0x8 9-bit data 0x9 10-bit data 0xA 11-bit data 0xB 12-bit data 0xC 13-bit data 0xD 14-bit data 0xE 15-bit data 0xF 16-bit data



## Register 2: SSI Control 1 (SSICR1), offset 0x004

**SSICR1** is control register 1 and contains bit fields that control various functions within the SSI module. Master and slave mode functionality is controlled by this register.

### SSI Control 1 (SSICR1)

SSI0 base: 0x4000.8000  
 SSI1 base: 0x4000.9000  
 Offset 0x004  
 Type R/W, reset 0x0000.0000

	31	30	29	28	27	26	25	24	23	22	21	20	19	18	17	16	
	reserved																
Type	RO	RO	RO	RO	RO	RO	RO	RO	RO	RO	RO	RO	RO	RO	RO	RO	
Reset	0	0	0	0	0	0	0	0	0	0	0	0	0	0	0	0	
	15	14	13	12	11	10	9	8	7	6	5	4	3	2	1	0	
	reserved													SOD	MS	SSE	LBM
Type	RO	RO	RO	RO	RO	RO	RO	RO	RO	RO	RO	RO	RO	R/W	R/W	R/W	R/W
Reset	0	0	0	0	0	0	0	0	0	0	0	0	0	0	0	0	0

Bit/Field	Name	Type	Reset	Description
31:4	reserved	RO	0x00	Software should not rely on the value of a reserved bit. To provide compatibility with future products, the value of a reserved bit should be preserved across a read-modify-write operation.
3	SOD	R/W	0	SSI Slave Mode Output Disable  This bit is relevant only in the Slave mode ( $MS=1$ ). In multiple-slave systems, it is possible for the SSI master to broadcast a message to all slaves in the system while ensuring that only one slave drives data onto the serial output line. In such systems, the TXD lines from multiple slaves could be tied together. To operate in such a system, the SOD bit can be configured so that the SSI slave does not drive the SSITx pin.  The SOD values are defined as follows:  Value Description 0 SSI can drive SSITx output in Slave Output mode. 1 SSI must not drive the SSITx output in Slave mode.
2	MS	R/W	0	SSI Master/Slave Select  This bit selects Master or Slave mode and can be modified only when SSI is disabled ( $SSE=0$ ).  The MS values are defined as follows:  Value Description 0 Device configured as a master. 1 Device configured as a slave.

Bit/Field	Name	Type	Reset	Description						
1	SSE	R/W	0	<p>SSI Synchronous Serial Port Enable</p> <p>Setting this bit enables SSI operation.</p> <p>The <code>SSE</code> values are defined as follows:</p> <table><thead><tr><th>Value</th><th>Description</th></tr></thead><tbody><tr><td>0</td><td>SSI operation disabled.</td></tr><tr><td>1</td><td>SSI operation enabled.</td></tr></tbody></table> <p><b>Note:</b> This bit must be set to 0 before any control registers are reprogrammed.</p>	Value	Description	0	SSI operation disabled.	1	SSI operation enabled.
Value	Description									
0	SSI operation disabled.									
1	SSI operation enabled.									
0	LBM	R/W	0	<p>SSI Loopback Mode</p> <p>Setting this bit enables Loopback Test mode.</p> <p>The <code>LBM</code> values are defined as follows:</p> <table><thead><tr><th>Value</th><th>Description</th></tr></thead><tbody><tr><td>0</td><td>Normal serial port operation enabled.</td></tr><tr><td>1</td><td>Output of the transmit serial shift register is connected internally to the input of the receive serial shift register.</td></tr></tbody></table>	Value	Description	0	Normal serial port operation enabled.	1	Output of the transmit serial shift register is connected internally to the input of the receive serial shift register.
Value	Description									
0	Normal serial port operation enabled.									
1	Output of the transmit serial shift register is connected internally to the input of the receive serial shift register.									

### Register 3: SSI Data (SSIDR), offset 0x008

**SSIDR** is the data register and is 16-bits wide. When **SSIDR** is read, the entry in the receive FIFO (pointed to by the current FIFO read pointer) is accessed. As data values are removed by the SSI receive logic from the incoming data frame, they are placed into the entry in the receive FIFO (pointed to by the current FIFO write pointer).

When **SSIDR** is written to, the entry in the transmit FIFO (pointed to by the write pointer) is written to. Data values are removed from the transmit FIFO one value at a time by the transmit logic. It is loaded into the transmit serial shifter, then serially shifted out onto the **SSITx** pin at the programmed bit rate.

When a data size of less than 16 bits is selected, the user must right-justify data written to the transmit FIFO. The transmit logic ignores the unused bits. Received data less than 16 bits is automatically right-justified in the receive buffer.

When the SSI is programmed for MICROWIRE frame format, the default size for transmit data is eight bits (the most significant byte is ignored). The receive data size is controlled by the programmer. The transmit FIFO and the receive FIFO are not cleared even when the **SSE** bit in the **SSICR1** register is set to zero. This allows the software to fill the transmit FIFO before enabling the SSI.

#### SSI Data (SSIDR)

SSI0 base: 0x4000.8000  
 SSI1 base: 0x4000.9000  
 Offset 0x008  
 Type R/W, reset 0x0000.0000

	31	30	29	28	27	26	25	24	23	22	21	20	19	18	17	16
	reserved															
Type	RO	RO	RO	RO	RO	RO	RO	RO	RO	RO	RO	RO	RO	RO	RO	RO
Reset	0	0	0	0	0	0	0	0	0	0	0	0	0	0	0	0
	15	14	13	12	11	10	9	8	7	6	5	4	3	2	1	0
	DATA															
Type	R/W	R/W	R/W	R/W	R/W	R/W	R/W	R/W	R/W	R/W	R/W	R/W	R/W	R/W	R/W	R/W
Reset	0	0	0	0	0	0	0	0	0	0	0	0	0	0	0	0

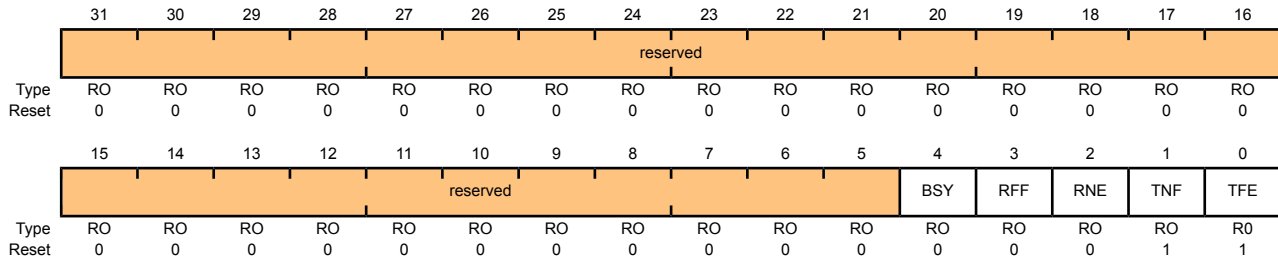
Bit/Field	Name	Type	Reset	Description
31:16	reserved	RO	0x0000	Software should not rely on the value of a reserved bit. To provide compatibility with future products, the value of a reserved bit should be preserved across a read-modify-write operation.
15:0	DATA	R/W	0x0000	SSI Receive/Transmit Data  A read operation reads the receive FIFO. A write operation writes the transmit FIFO.  Software must right-justify data when the SSI is programmed for a data size that is less than 16 bits. Unused bits at the top are ignored by the transmit logic. The receive logic automatically right-justifies the data.

### Register 4: SSI Status (SSISR), offset 0x00C

SSISR is a status register that contains bits that indicate the FIFO fill status and the SSI busy status.

#### SSI Status (SSISR)

SSI0 base: 0x4000.8000  
 SSI1 base: 0x4000.9000  
 Offset 0x00C  
 Type RO, reset 0x0000.0003



Bit/Field	Name	Type	Reset	Description
31:5	reserved	RO	0x00	Software should not rely on the value of a reserved bit. To provide compatibility with future products, the value of a reserved bit should be preserved across a read-modify-write operation.
4	BSY	RO	0	SSI Busy Bit  The BSY values are defined as follows:  Value Description 0 SSI is idle. 1 SSI is currently transmitting and/or receiving a frame, or the transmit FIFO is not empty.
3	RFF	RO	0	SSI Receive FIFO Full  The RFF values are defined as follows:  Value Description 0 Receive FIFO is not full. 1 Receive FIFO is full.
2	RNE	RO	0	SSI Receive FIFO Not Empty  The RNE values are defined as follows:  Value Description 0 Receive FIFO is empty. 1 Receive FIFO is not empty.

---

Bit/Field	Name	Type	Reset	Description
1	TNF	RO	1	SSI Transmit FIFO Not Full The <code>TNF</code> values are defined as follows:  Value Description 0 Transmit FIFO is full. 1 Transmit FIFO is not full.
0	TFE	RO	1	SSI Transmit FIFO Empty The <code>TFE</code> values are defined as follows:  Value Description 0 Transmit FIFO is not empty. 1 Transmit FIFO is empty.

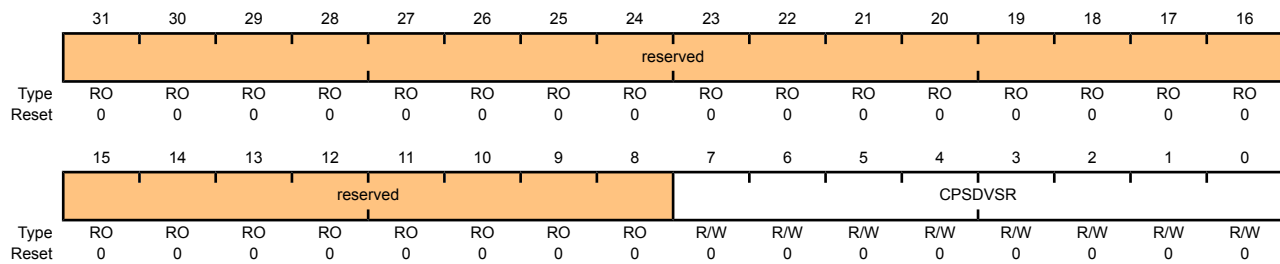
### Register 5: SSI Clock Prescale (SSICPSR), offset 0x010

**SSICPSR** is the clock prescale register and specifies the division factor by which the system clock must be internally divided before further use.

The value programmed into this register must be an even number between 2 and 254. The least-significant bit of the programmed number is hard-coded to zero. If an odd number is written to this register, data read back from this register has the least-significant bit as zero.

#### SSI Clock Prescale (SSICPSR)

SSI0 base: 0x4000.8000  
 SSI1 base: 0x4000.9000  
 Offset 0x010  
 Type R/W, reset 0x0000.0000



Bit/Field	Name	Type	Reset	Description
31:8	reserved	RO	0x00	Software should not rely on the value of a reserved bit. To provide compatibility with future products, the value of a reserved bit should be preserved across a read-modify-write operation.
7:0	CPSDVSR	R/W	0x00	SSI Clock Prescale Divisor  This value must be an even number from 2 to 254, depending on the frequency of <code>SSIClk</code> . The LSB always returns 0 on reads.

## Register 6: SSI Interrupt Mask (SSIIM), offset 0x014

The **SSIIM** register is the interrupt mask set or clear register. It is a read/write register and all bits are cleared to 0 on reset.

On a read, this register gives the current value of the mask on the relevant interrupt. A write of 1 to the particular bit sets the mask, enabling the interrupt to be read. A write of 0 clears the corresponding mask.

### SSI Interrupt Mask (SSIIM)

SSI0 base: 0x4000.8000  
 SSI1 base: 0x4000.9000  
 Offset 0x014  
 Type R/W, reset 0x0000.0000

	31	30	29	28	27	26	25	24	23	22	21	20	19	18	17	16	
	reserved																
Type	RO	RO	RO	RO	RO	RO	RO	RO	RO	RO	RO	RO	RO	RO	RO	RO	
Reset	0	0	0	0	0	0	0	0	0	0	0	0	0	0	0	0	
	15	14	13	12	11	10	9	8	7	6	5	4	3	2	1	0	
	reserved													TXIM	RXIM	RTIM	RORIM
Type	RO	RO	RO	RO	RO	RO	RO	RO	RO	RO	RO	RO	RO	R/W	R/W	R/W	R/W
Reset	0	0	0	0	0	0	0	0	0	0	0	0	0	0	0	0	

Bit/Field	Name	Type	Reset	Description
31:4	reserved	RO	0x00	Software should not rely on the value of a reserved bit. To provide compatibility with future products, the value of a reserved bit should be preserved across a read-modify-write operation.
3	TXIM	R/W	0	SSI Transmit FIFO Interrupt Mask The <b>TXIM</b> values are defined as follows: Value Description 0 TX FIFO half-full or less condition interrupt is masked. 1 TX FIFO half-full or less condition interrupt is not masked.
2	RXIM	R/W	0	SSI Receive FIFO Interrupt Mask The <b>TFE</b> values are defined as follows: Value Description 0 RX FIFO half-full or more condition interrupt is masked. 1 RX FIFO half-full or more condition interrupt is not masked.
1	RTIM	R/W	0	SSI Receive Time-Out Interrupt Mask The <b>RTIM</b> values are defined as follows: Value Description 0 RX FIFO time-out interrupt is masked. 1 RX FIFO time-out interrupt is not masked.

Bit/Field	Name	Type	Reset	Description
0	RORIM	R/W	0	SSI Receive Overrun Interrupt Mask The RORIM values are defined as follows:  Value Description 0 RX FIFO overrun interrupt is masked. 1 RX FIFO overrun interrupt is not masked.



## Register 7: SSI Raw Interrupt Status (SSIRIS), offset 0x018

The **SSIRIS** register is the raw interrupt status register. On a read, this register gives the current raw status value of the corresponding interrupt prior to masking. A write has no effect.

### SSI Raw Interrupt Status (SSIRIS)

SSI0 base: 0x4000.8000  
 SSI1 base: 0x4000.9000  
 Offset 0x018  
 Type RO, reset 0x0000.0008

	31	30	29	28	27	26	25	24	23	22	21	20	19	18	17	16
	reserved															
Type	RO	RO	RO	RO	RO	RO	RO	RO	RO	RO	RO	RO	RO	RO	RO	RO
Reset	0	0	0	0	0	0	0	0	0	0	0	0	0	0	0	0
	15	14	13	12	11	10	9	8	7	6	5	4	3	2	1	0
	reserved												TXRIS	RXRIS	RTRIS	RORRIS
Type	RO	RO	RO	RO	RO	RO	RO	RO	RO	RO	RO	RO	RO	RO	RO	RO
Reset	0	0	0	0	0	0	0	0	0	0	0	0	1	0	0	0

Bit/Field	Name	Type	Reset	Description
31:4	reserved	RO	0x00	Software should not rely on the value of a reserved bit. To provide compatibility with future products, the value of a reserved bit should be preserved across a read-modify-write operation.
3	TXRIS	RO	1	SSI Transmit FIFO Raw Interrupt Status Indicates that the transmit FIFO is half full or less, when set.
2	RXRIS	RO	0	SSI Receive FIFO Raw Interrupt Status Indicates that the receive FIFO is half full or more, when set.
1	RTRIS	RO	0	SSI Receive Time-Out Raw Interrupt Status Indicates that the receive time-out has occurred, when set.
0	RORRIS	RO	0	SSI Receive Overrun Raw Interrupt Status Indicates that the receive FIFO has overflowed, when set.

### Register 8: SSI Masked Interrupt Status (SSIMIS), offset 0x01C

The **SSIMIS** register is the masked interrupt status register. On a read, this register gives the current masked status value of the corresponding interrupt. A write has no effect.

#### SSI Masked Interrupt Status (SSIMIS)

SSI0 base: 0x4000.8000  
 SSI1 base: 0x4000.9000  
 Offset 0x01C  
 Type RO, reset 0x0000.0000

	31	30	29	28	27	26	25	24	23	22	21	20	19	18	17	16	
	reserved																
Type	RO	RO	RO	RO	RO	RO	RO	RO	RO	RO	RO	RO	RO	RO	RO	RO	
Reset	0	0	0	0	0	0	0	0	0	0	0	0	0	0	0	0	
	15	14	13	12	11	10	9	8	7	6	5	4	3	2	1	0	
	reserved													TXMIS	RXMIS	RTMIS	RORMIS
Type	RO	RO	RO	RO	RO	RO	RO	RO	RO	RO	RO	RO	RO	RO	RO	RO	
Reset	0	0	0	0	0	0	0	0	0	0	0	0	0	0	0	0	

Bit/Field	Name	Type	Reset	Description
31:4	reserved	RO	0	Software should not rely on the value of a reserved bit. To provide compatibility with future products, the value of a reserved bit should be preserved across a read-modify-write operation.
3	TXMIS	RO	0	SSI Transmit FIFO Masked Interrupt Status Indicates that the transmit FIFO is half full or less, when set.
2	RXMIS	RO	0	SSI Receive FIFO Masked Interrupt Status Indicates that the receive FIFO is half full or more, when set.
1	RTMIS	RO	0	SSI Receive Time-Out Masked Interrupt Status Indicates that the receive time-out has occurred, when set.
0	RORMIS	RO	0	SSI Receive Overrun Masked Interrupt Status Indicates that the receive FIFO has overflowed, when set.

### Register 9: SSI Interrupt Clear (SSIICR), offset 0x020

The **SSIICR** register is the interrupt clear register. On a write of 1, the corresponding interrupt is cleared. A write of 0 has no effect.

#### SSI Interrupt Clear (SSIICR)

SSI0 base: 0x4000.8000  
 SSI1 base: 0x4000.9000  
 Offset 0x020  
 Type W1C, reset 0x0000.0000

	31	30	29	28	27	26	25	24	23	22	21	20	19	18	17	16	
	reserved																
Type	RO	RO	RO	RO	RO	RO	RO	RO	RO	RO	RO	RO	RO	RO	RO	RO	
Reset	0	0	0	0	0	0	0	0	0	0	0	0	0	0	0	0	
	15	14	13	12	11	10	9	8	7	6	5	4	3	2	1	0	
	reserved														RTIC	RORIC	
Type	RO	RO	RO	RO	RO	RO	RO	RO	RO	RO	RO	RO	RO	RO	RO	W1C	W1C
Reset	0	0	0	0	0	0	0	0	0	0	0	0	0	0	0	0	0

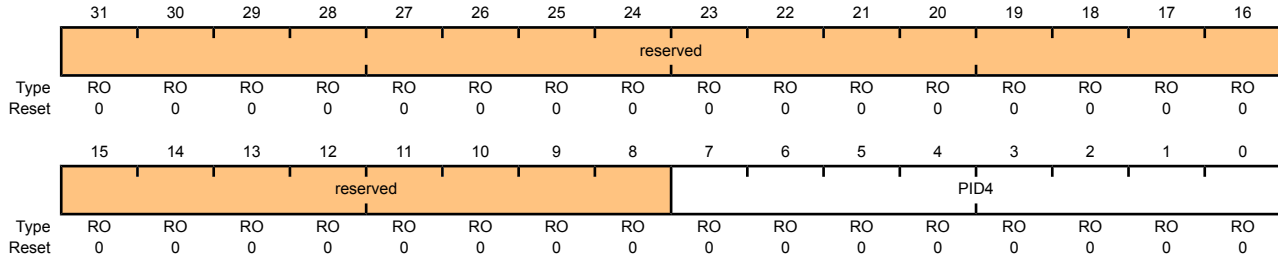
Bit/Field	Name	Type	Reset	Description
31:2	reserved	RO	0x00	Software should not rely on the value of a reserved bit. To provide compatibility with future products, the value of a reserved bit should be preserved across a read-modify-write operation.
1	RTIC	W1C	0	SSI Receive Time-Out Interrupt Clear  The <b>RTIC</b> values are defined as follows:  Value Description 0 No effect on interrupt. 1 Clears interrupt.
0	RORIC	W1C	0	SSI Receive Overrun Interrupt Clear  The <b>RORIC</b> values are defined as follows:  Value Description 0 No effect on interrupt. 1 Clears interrupt.

### Register 10: SSI Peripheral Identification 4 (SSIPeriphID4), offset 0xFD0

The **SSIPeriphIDn** registers are hard-coded and the fields within the register determine the reset value.

#### SSI Peripheral Identification 4 (SSIPeriphID4)

SSI0 base: 0x4000.8000  
 SSI1 base: 0x4000.9000  
 Offset 0xFD0  
 Type RO, reset 0x0000.0000



Bit/Field	Name	Type	Reset	Description
31:8	reserved	RO	0x00	Software should not rely on the value of a reserved bit. To provide compatibility with future products, the value of a reserved bit should be preserved across a read-modify-write operation.
7:0	PID4	RO	0x00	SSI Peripheral ID Register[7:0]  Can be used by software to identify the presence of this peripheral.

## Register 11: SSI Peripheral Identification 5 (SSIPeriphID5), offset 0xFD4

The **SSIPeriphIDn** registers are hard-coded and the fields within the register determine the reset value.

### SSI Peripheral Identification 5 (SSIPeriphID5)

SSI0 base: 0x4000.8000  
 SSI1 base: 0x4000.9000  
 Offset 0xFD4  
 Type RO, reset 0x0000.0000

	31	30	29	28	27	26	25	24	23	22	21	20	19	18	17	16
	reserved															
Type	RO	RO	RO	RO	RO	RO	RO	RO	RO	RO	RO	RO	RO	RO	RO	RO
Reset	0	0	0	0	0	0	0	0	0	0	0	0	0	0	0	0
	15	14	13	12	11	10	9	8	7	6	5	4	3	2	1	0
	reserved								PID5							
Type	RO	RO	RO	RO	RO	RO	RO	RO	RO	RO	RO	RO	RO	RO	RO	RO
Reset	0	0	0	0	0	0	0	0	0	0	0	0	0	0	0	0

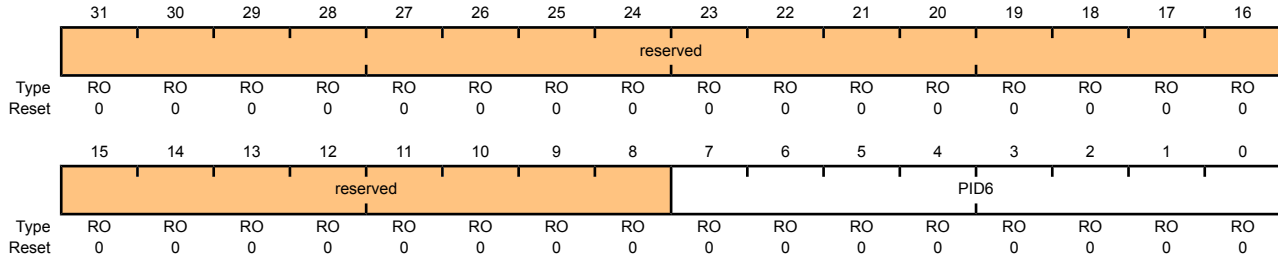
Bit/Field	Name	Type	Reset	Description
31:8	reserved	RO	0x00	Software should not rely on the value of a reserved bit. To provide compatibility with future products, the value of a reserved bit should be preserved across a read-modify-write operation.
7:0	PID5	RO	0x00	SSI Peripheral ID Register[15:8]  Can be used by software to identify the presence of this peripheral.

### Register 12: SSI Peripheral Identification 6 (SSIPeriphID6), offset 0xFD8

The **SSIPeriphIDn** registers are hard-coded and the fields within the register determine the reset value.

#### SSI Peripheral Identification 6 (SSIPeriphID6)

SSI0 base: 0x4000.8000  
 SSI1 base: 0x4000.9000  
 Offset 0xFD8  
 Type RO, reset 0x0000.0000



Bit/Field	Name	Type	Reset	Description
31:8	reserved	RO	0x00	Software should not rely on the value of a reserved bit. To provide compatibility with future products, the value of a reserved bit should be preserved across a read-modify-write operation.
7:0	PID6	RO	0x00	SSI Peripheral ID Register[23:16]  Can be used by software to identify the presence of this peripheral.

**Register 13: SSI Peripheral Identification 7 (SSIPeriphID7), offset 0xFDC**

The **SSIPeriphIDn** registers are hard-coded and the fields within the register determine the reset value.

**SSI Peripheral Identification 7 (SSIPeriphID7)**

SSI0 base: 0x4000.8000  
 SSI1 base: 0x4000.9000  
 Offset 0xFDC  
 Type RO, reset 0x0000.0000

	31	30	29	28	27	26	25	24	23	22	21	20	19	18	17	16
	reserved															
Type	RO	RO	RO	RO	RO	RO	RO	RO	RO	RO	RO	RO	RO	RO	RO	RO
Reset	0	0	0	0	0	0	0	0	0	0	0	0	0	0	0	0
	15	14	13	12	11	10	9	8	7	6	5	4	3	2	1	0
	reserved								PID7							
Type	RO	RO	RO	RO	RO	RO	RO	RO	RO	RO	RO	RO	RO	RO	RO	RO
Reset	0	0	0	0	0	0	0	0	0	0	0	0	0	0	0	0

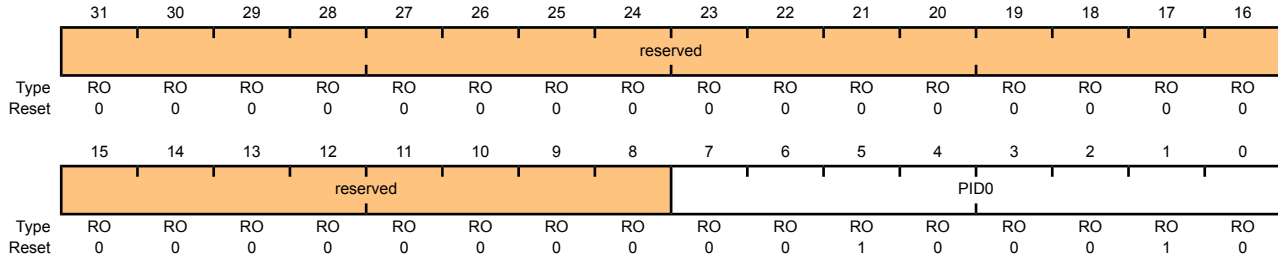
Bit/Field	Name	Type	Reset	Description
31:8	reserved	RO	0x00	Software should not rely on the value of a reserved bit. To provide compatibility with future products, the value of a reserved bit should be preserved across a read-modify-write operation.
7:0	PID7	RO	0x00	SSI Peripheral ID Register[31:24]  Can be used by software to identify the presence of this peripheral.

### Register 14: SSI Peripheral Identification 0 (SSIPeriphID0), offset 0xFE0

The **SSIPeriphIDn** registers are hard-coded and the fields within the register determine the reset value.

#### SSI Peripheral Identification 0 (SSIPeriphID0)

SSI0 base: 0x4000.8000  
 SSI1 base: 0x4000.9000  
 Offset 0xFE0  
 Type RO, reset 0x0000.0022



Bit/Field	Name	Type	Reset	Description
31:8	reserved	RO	0	Software should not rely on the value of a reserved bit. To provide compatibility with future products, the value of a reserved bit should be preserved across a read-modify-write operation.
7:0	PID0	RO	0x22	SSI Peripheral ID Register[7:0]  Can be used by software to identify the presence of this peripheral.



## Register 15: SSI Peripheral Identification 1 (SSIPeriphID1), offset 0xFE4

The **SSIPeriphIDn** registers are hard-coded and the fields within the register determine the reset value.

### SSI Peripheral Identification 1 (SSIPeriphID1)

SSI0 base: 0x4000.8000  
 SSI1 base: 0x4000.9000  
 Offset 0xFE4  
 Type RO, reset 0x0000.0000

	31	30	29	28	27	26	25	24	23	22	21	20	19	18	17	16
	reserved															
Type	RO	RO	RO	RO	RO	RO	RO	RO	RO	RO	RO	RO	RO	RO	RO	RO
Reset	0	0	0	0	0	0	0	0	0	0	0	0	0	0	0	0
	15	14	13	12	11	10	9	8	7	6	5	4	3	2	1	0
	reserved								PID1							
Type	RO	RO	RO	RO	RO	RO	RO	RO	RO	RO	RO	RO	RO	RO	RO	RO
Reset	0	0	0	0	0	0	0	0	0	0	0	0	0	0	0	0

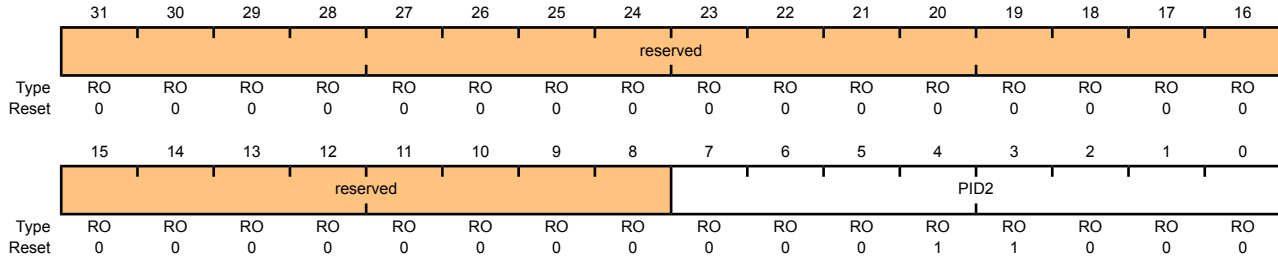
Bit/Field	Name	Type	Reset	Description
31:8	reserved	RO	0x00	Software should not rely on the value of a reserved bit. To provide compatibility with future products, the value of a reserved bit should be preserved across a read-modify-write operation.
7:0	PID1	RO	0x00	SSI Peripheral ID Register [15:8]  Can be used by software to identify the presence of this peripheral.

### Register 16: SSI Peripheral Identification 2 (SSIPeriphID2), offset 0xFE8

The **SSIPeriphIDn** registers are hard-coded and the fields within the register determine the reset value.

#### SSI Peripheral Identification 2 (SSIPeriphID2)

SSI0 base: 0x4000.8000  
 SSI1 base: 0x4000.9000  
 Offset 0xFE8  
 Type RO, reset 0x0000.0018



Bit/Field	Name	Type	Reset	Description
31:8	reserved	RO	0x00	Software should not rely on the value of a reserved bit. To provide compatibility with future products, the value of a reserved bit should be preserved across a read-modify-write operation.
7:0	PID2	RO	0x18	SSI Peripheral ID Register [23:16]  Can be used by software to identify the presence of this peripheral.

## Register 17: SSI Peripheral Identification 3 (SSIPeriphID3), offset 0xFEC

The **SSIPeriphIDn** registers are hard-coded and the fields within the register determine the reset value.

### SSI Peripheral Identification 3 (SSIPeriphID3)

SSI0 base: 0x4000.8000

SSI1 base: 0x4000.9000

Offset 0xFEC

Type RO, reset 0x0000.0001

	31	30	29	28	27	26	25	24	23	22	21	20	19	18	17	16
	reserved															
Type	RO	RO	RO	RO	RO	RO	RO	RO	RO	RO	RO	RO	RO	RO	RO	RO
Reset	0	0	0	0	0	0	0	0	0	0	0	0	0	0	0	0
	15	14	13	12	11	10	9	8	7	6	5	4	3	2	1	0
	reserved								PID3							
Type	RO	RO	RO	RO	RO	RO	RO	RO	RO	RO	RO	RO	RO	RO	RO	RO
Reset	0	0	0	0	0	0	0	0	0	0	0	0	0	0	0	1

Bit/Field	Name	Type	Reset	Description
31:8	reserved	RO	0x00	Software should not rely on the value of a reserved bit. To provide compatibility with future products, the value of a reserved bit should be preserved across a read-modify-write operation.
7:0	PID3	RO	0x01	SSI Peripheral ID Register [31:24] Can be used by software to identify the presence of this peripheral.

### Register 18: SSI PrimeCell Identification 0 (SSIPCellID0), offset 0xFF0

The **SSIPCellIDn** registers are hard-coded and the fields within the register determine the reset value.

#### SSI PrimeCell Identification 0 (SSIPCellID0)

SSI0 base: 0x4000.8000  
 SSI1 base: 0x4000.9000  
 Offset 0xFF0  
 Type RO, reset 0x0000.000D

	31	30	29	28	27	26	25	24	23	22	21	20	19	18	17	16
	reserved															
Type	RO	RO	RO	RO	RO	RO	RO	RO	RO	RO	RO	RO	RO	RO	RO	RO
Reset	0	0	0	0	0	0	0	0	0	0	0	0	0	0	0	0
	15	14	13	12	11	10	9	8	7	6	5	4	3	2	1	0
	reserved								CID0							
Type	RO	RO	RO	RO	RO	RO	RO	RO	RO	RO	RO	RO	RO	RO	RO	RO
Reset	0	0	0	0	0	0	0	0	0	0	0	0	1	1	0	1

Bit/Field	Name	Type	Reset	Description
31:8	reserved	RO	0x00	Software should not rely on the value of a reserved bit. To provide compatibility with future products, the value of a reserved bit should be preserved across a read-modify-write operation.
7:0	CID0	RO	0x0D	SSI PrimeCell ID Register [7:0]  Provides software a standard cross-peripheral identification system.

## Register 19: SSI PrimeCell Identification 1 (SSIPCellID1), offset 0xFF4

The **SSIPCellIDn** registers are hard-coded and the fields within the register determine the reset value.

### SSI PrimeCell Identification 1 (SSIPCellID1)

SSI0 base: 0x4000.8000  
 SSI1 base: 0x4000.9000  
 Offset 0xFF4  
 Type RO, reset 0x0000.00F0

	31	30	29	28	27	26	25	24	23	22	21	20	19	18	17	16
	reserved															
Type	RO	RO	RO	RO	RO	RO	RO	RO	RO	RO	RO	RO	RO	RO	RO	RO
Reset	0	0	0	0	0	0	0	0	0	0	0	0	0	0	0	0
	15	14	13	12	11	10	9	8	7	6	5	4	3	2	1	0
	reserved								CID1							
Type	RO	RO	RO	RO	RO	RO	RO	RO	RO	RO	RO	RO	RO	RO	RO	RO
Reset	0	0	0	0	0	0	0	0	1	1	1	1	0	0	0	0

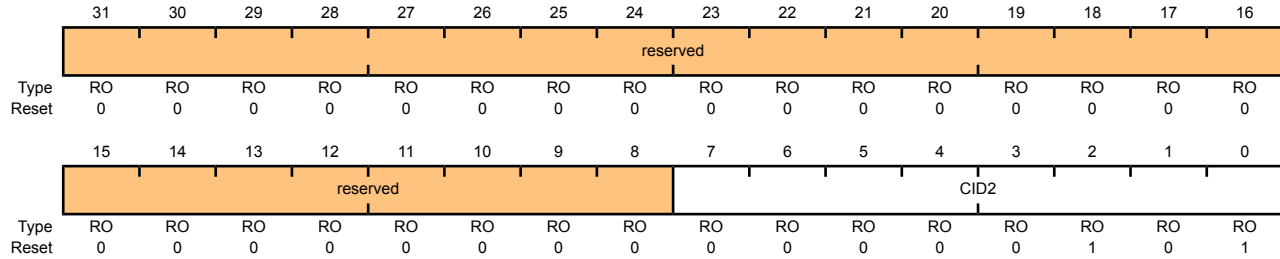
Bit/Field	Name	Type	Reset	Description
31:8	reserved	RO	0x00	Software should not rely on the value of a reserved bit. To provide compatibility with future products, the value of a reserved bit should be preserved across a read-modify-write operation.
7:0	CID1	RO	0xF0	SSI PrimeCell ID Register [15:8] Provides software a standard cross-peripheral identification system.

### Register 20: SSI PrimeCell Identification 2 (SSIPCellID2), offset 0xFF8

The **SSIPCellIDn** registers are hard-coded and the fields within the register determine the reset value.

#### SSI PrimeCell Identification 2 (SSIPCellID2)

SSI0 base: 0x4000.8000  
 SSI1 base: 0x4000.9000  
 Offset 0xFF8  
 Type RO, reset 0x0000.0005



Bit/Field	Name	Type	Reset	Description
31:8	reserved	RO	0x00	Software should not rely on the value of a reserved bit. To provide compatibility with future products, the value of a reserved bit should be preserved across a read-modify-write operation.
7:0	CID2	RO	0x05	SSI PrimeCell ID Register [23:16] Provides software a standard cross-peripheral identification system.

**Register 21: SSI PrimeCell Identification 3 (SSIPCellID3), offset 0xFFC**

The **SSIPCellIDn** registers are hard-coded and the fields within the register determine the reset value.

**SSI PrimeCell Identification 3 (SSIPCellID3)**

SSI0 base: 0x4000.8000  
 SSI1 base: 0x4000.9000  
 Offset 0xFFC  
 Type RO, reset 0x0000.00B1

	31	30	29	28	27	26	25	24	23	22	21	20	19	18	17	16
	reserved															
Type	RO	RO	RO	RO	RO	RO	RO	RO	RO	RO	RO	RO	RO	RO	RO	RO
Reset	0	0	0	0	0	0	0	0	0	0	0	0	0	0	0	0
	15	14	13	12	11	10	9	8	7	6	5	4	3	2	1	0
	reserved								CID3							
Type	RO	RO	RO	RO	RO	RO	RO	RO	RO	RO	RO	RO	RO	RO	RO	RO
Reset	0	0	0	0	0	0	0	0	1	0	1	1	0	0	0	1

Bit/Field	Name	Type	Reset	Description
31:8	reserved	RO	0x00	Software should not rely on the value of a reserved bit. To provide compatibility with future products, the value of a reserved bit should be preserved across a read-modify-write operation.
7:0	CID3	RO	0xB1	SSI PrimeCell ID Register [31:24] Provides software a standard cross-peripheral identification system.

## 15 Inter-Integrated Circuit (I<sup>2</sup>C) Interface

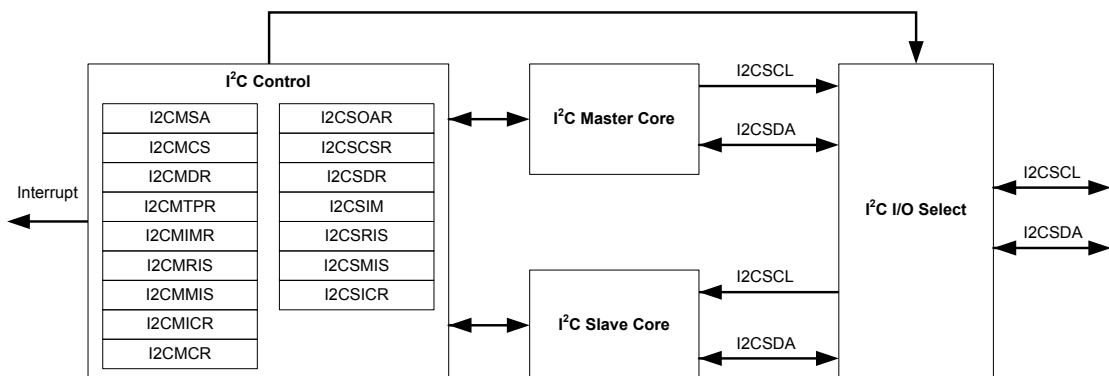
The Inter-Integrated Circuit (I<sup>2</sup>C) bus provides bi-directional data transfer through a two-wire design (a serial data line SDA and a serial clock line SCL), and interfaces to external I<sup>2</sup>C devices such as serial memory (RAMs and ROMs), networking devices, LCDs, tone generators, and so on. The I<sup>2</sup>C bus may also be used for system testing and diagnostic purposes in product development and manufacture. The LM3S1138 microcontroller includes two I<sup>2</sup>C modules, providing the ability to interact (both send and receive) with other I<sup>2</sup>C devices on the bus.

Devices on the I<sup>2</sup>C bus can be designated as either a master or a slave. Each Stellaris<sup>®</sup> I<sup>2</sup>C module supports both sending and receiving data as either a master or a slave, and also supports the simultaneous operation as both a master and a slave. There are a total of four I<sup>2</sup>C modes: Master Transmit, Master Receive, Slave Transmit, and Slave Receive. The Stellaris<sup>®</sup> I<sup>2</sup>C modules can operate at two speeds: Standard (100 Kbps) and Fast (400 Kbps).

Both the I<sup>2</sup>C master and slave can generate interrupts; the I<sup>2</sup>C master generates interrupts when a transmit or receive operation completes (or aborts due to an error) and the I<sup>2</sup>C slave generates interrupts when data has been sent or requested by a master.

### 15.1 Block Diagram

Figure 15-1. I<sup>2</sup>C Block Diagram

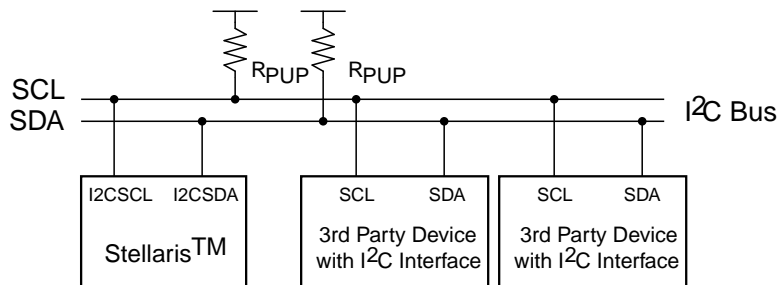


### 15.2 Functional Description

Each I<sup>2</sup>C module is comprised of both master and slave functions which are implemented as separate peripherals. For proper operation, the SDA and SCL pins must be connected to bi-directional open-drain pads. A typical I<sup>2</sup>C bus configuration is shown in Figure 15-2 on page 369.

See "I<sup>2</sup>C" on page 436 for I<sup>2</sup>C timing diagrams.



Figure 15-2. I<sup>2</sup>C Bus Configuration

## 15.2.1 I<sup>2</sup>C Bus Functional Overview

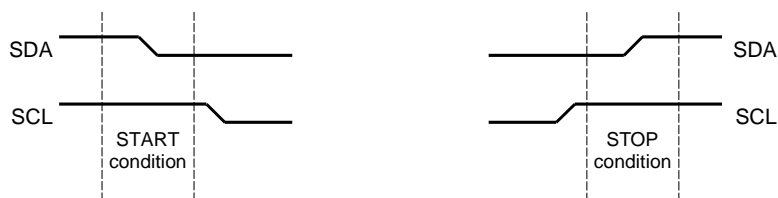
The I<sup>2</sup>C bus uses only two signals: SDA and SCL, named I2CSDA and I2CSCL on Stellaris<sup>®</sup> microcontrollers. SDA is the bi-directional serial data line and SCL is the bi-directional serial clock line. The bus is considered idle when both lines are high.

Every transaction on the I<sup>2</sup>C bus is nine bits long, consisting of eight data bits and a single acknowledge bit. The number of bytes per transfer (defined as the time between a valid START and STOP condition, described in “START and STOP Conditions” on page 369) is unrestricted, but each byte has to be followed by an acknowledge bit, and data must be transferred MSB first. When a receiver cannot receive another complete byte, it can hold the clock line SCL Low and force the transmitter into a wait state. The data transfer continues when the receiver releases the clock SCL.

### 15.2.1.1 START and STOP Conditions

The protocol of the I<sup>2</sup>C bus defines two states to begin and end a transaction: START and STOP. A high-to-low transition on the SDA line while the SCL is high is defined as a START condition, and a low-to-high transition on the SDA line while SCL is high is defined as a STOP condition. The bus is considered busy after a START condition and free after a STOP condition. See Figure 15-3 on page 369.

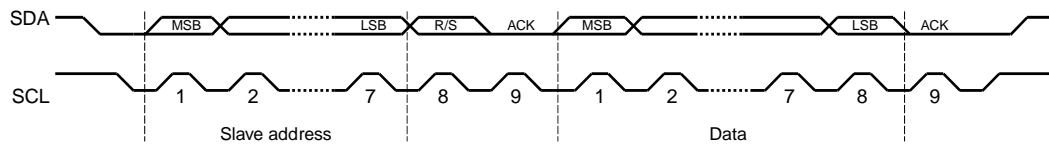
Figure 15-3. START and STOP Conditions



### 15.2.1.2 Data Format with 7-Bit Address

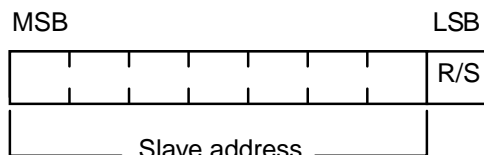
Data transfers follow the format shown in Figure 15-4 on page 370. After the START condition, a slave address is sent. This address is 7-bits long followed by an eighth bit, which is a data direction bit (R/S bit in the I2CMSA register). A zero indicates a transmit operation (send), and a one indicates a request for data (receive). A data transfer is always terminated by a STOP condition generated by the master, however, a master can initiate communications with another device on the bus by generating a repeated START condition and addressing another slave without first generating a STOP condition. Various combinations of receive/send formats are then possible within a single transfer.

**Figure 15-4. Complete Data Transfer with a 7-Bit Address**



The first seven bits of the first byte make up the slave address (see Figure 15-5 on page 370). The eighth bit determines the direction of the message. A zero in the R/S position of the first byte means that the master will write (send) data to the selected slave, and a one in this position means that the master will receive data from the slave.

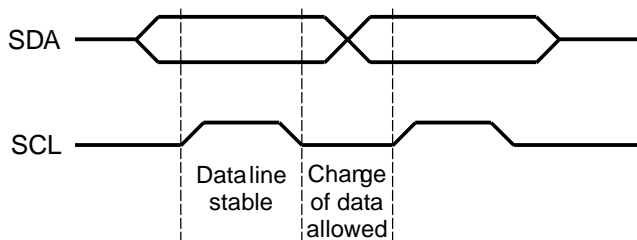
**Figure 15-5. R/S Bit in First Byte**



### 15.2.1.3 Data Validity

The data on the SDA line must be stable during the high period of the clock, and the data line can only change when SCL is low (see Figure 15-6 on page 370).

**Figure 15-6. Data Validity During Bit Transfer on the I<sup>2</sup>C Bus**



### 15.2.1.4 Acknowledge

All bus transactions have a required acknowledge clock cycle that is generated by the master. During the acknowledge cycle, the transmitter (which can be the master or slave) releases the SDA line. To acknowledge the transaction, the receiver must pull down SDA during the acknowledge clock cycle. The data sent out by the receiver during the acknowledge cycle must comply with the data validity requirements described in “Data Validity” on page 370.

When a slave receiver does not acknowledge the slave address, SDA must be left high by the slave so that the master can generate a STOP condition and abort the current transfer. If the master device is acting as a receiver during a transfer, it is responsible for acknowledging each transfer made by the slave. Since the master controls the number of bytes in the transfer, it signals the end of data to the slave transmitter by not generating an acknowledge on the last data byte. The slave transmitter must then release SDA to allow the master to generate the STOP or a repeated START condition.

### 15.2.1.5 Arbitration

A master may start a transfer only if the bus is idle. It's possible for two or more masters to generate a START condition within minimum hold time of the START condition. In these situations, an arbitration scheme takes place on the SDA line, while SCL is high. During arbitration, the first of the competing master devices to place a '1' (high) on SDA while another master transmits a '0' (low) will switch off its data output stage and retire until the bus is idle again.

Arbitration can take place over several bits. Its first stage is a comparison of address bits, and if both masters are trying to address the same device, arbitration continues on to the comparison of data bits.

### 15.2.2 Available Speed Modes

The I<sup>2</sup>C clock rate is determined by the parameters: CLK\_PRD, TIMER\_PRD, SCL\_LP, and SCL\_HP. where:

CLK\_PRD is the system clock period

SCL\_LP is the low phase of SCL (fixed at 6)

SCL\_HP is the high phase of SCL (fixed at 4)

TIMER\_PRD is the programmed value in the **I<sup>2</sup>C Master Timer Period (I2CMTPR)** register (see page 388).

The I<sup>2</sup>C clock period is calculated as follows:

$$\text{SCL\_PERIOD} = 2 * (1 + \text{TIMER\_PRD}) * (\text{SCL\_LP} + \text{SCL\_HP}) * \text{CLK\_PRD}$$

For example:

CLK\_PRD = 50 ns

TIMER\_PRD = 2

SCL\_LP=6

SCL\_HP=4

yields a SCL frequency of:

$$1/T = 333 \text{ Khz}$$

Table 15-1 on page 371 gives examples of timer period, system clock, and speed mode (Standard or Fast).

**Table 15-1. Examples of I<sup>2</sup>C Master Timer Period versus Speed Mode**

System Clock	Timer Period	Standard Mode	Timer Period	Fast Mode
4 Mhz	0x01	100 Kbps	-	-
6 Mhz	0x02	100 Kbps	-	-
12.5 Mhz	0x06	89 Kbps	0x01	312 Kbps
16.7 Mhz	0x08	93 Kbps	0x02	278 Kbps
20 Mhz	0x09	100 Kbps	0x02	333 Kbps
33Mhz	0x10	97.1 Kbps	0x04	330 Kbps
40Mhz	0x13	100 Kbps	0x04	400 Kbps
50Mhz	0x18	100 Kbps	0x06	357 Kbps

### 15.2.3 Interrupts

The I<sup>2</sup>C can generate interrupts when the following conditions are observed:

- Master transaction completed
- Master transaction error
- Slave transaction received
- Slave transaction requested

There is a separate interrupt signal for the I<sup>2</sup>C master and I<sup>2</sup>C modules. While both modules can generate interrupts for multiple conditions, only a single interrupt signal is sent to the interrupt controller.

#### 15.2.3.1 I<sup>2</sup>C Master Interrupts

The I<sup>2</sup>C master module generates an interrupt when a transaction completes (either transmit or receive), or when an error occurs during a transaction. To enable the I<sup>2</sup>C master interrupt, software must write a '1' to the **I<sup>2</sup>C Master Interrupt Mask (I2CMIMR)** register. When an interrupt condition is met, software must check the `ERROR` bit in the **I<sup>2</sup>C Master Control/Status (I2CMCS)** register to verify that an error didn't occur during the last transaction. An error condition is asserted if the last transaction wasn't acknowledge by the slave or if the master was forced to give up ownership of the bus due to a lost arbitration round with another master. If an error is not detected, the application can proceed with the transfer. The interrupt is cleared by writing a '1' to the **I<sup>2</sup>C Master Interrupt Clear (I2CMICR)** register.

If the application doesn't require the use of interrupts, the raw interrupt status is always visible via the **I<sup>2</sup>C Master Raw Interrupt Status (I2CMRIS)** register.

#### 15.2.3.2 I<sup>2</sup>C Slave Interrupts

The slave module generates interrupts as it receives requests from an I<sup>2</sup>C master. To enable the I<sup>2</sup>C slave interrupt, write a '1' to the **I<sup>2</sup>C Slave Interrupt Mask (I2CSIMR)** register. Software determines whether the module should write (transmit) or read (receive) data from the **I<sup>2</sup>C Slave Data (I2CSDR)** register, by checking the `RREQ` and `TREQ` bits of the **I<sup>2</sup>C Slave Control/Status (I2CSCSR)** register. If the slave module is in receive mode and the first byte of a transfer is received, the `FBR` bit is set along with the `RREQ` bit. The interrupt is cleared by writing a '1' to the **I<sup>2</sup>C Slave Interrupt Clear (I2CSICR)** register.

If the application doesn't require the use of interrupts, the raw interrupt status is always visible via the **I<sup>2</sup>C Slave Raw Interrupt Status (I2CSRIS)** register.

### 15.2.4 Loopback Operation

The I<sup>2</sup>C modules can be placed into an internal loopback mode for diagnostic or debug work. This is accomplished by setting the `LPBK` bit in the **I<sup>2</sup>C Master Configuration (I2CMCR)** register. In loopback mode, the SDA and SCL signals from the master and slave modules are tied together.

### 15.2.5 Command Sequence Flow Charts

This section details the steps required to perform the various I<sup>2</sup>C transfer types in both master and slave mode.

### 15.2.5.1 I<sup>2</sup>C Master Command Sequences

The figures that follow show the command sequences available for the I<sup>2</sup>C master.

**Figure 15-7. Master Single SEND**

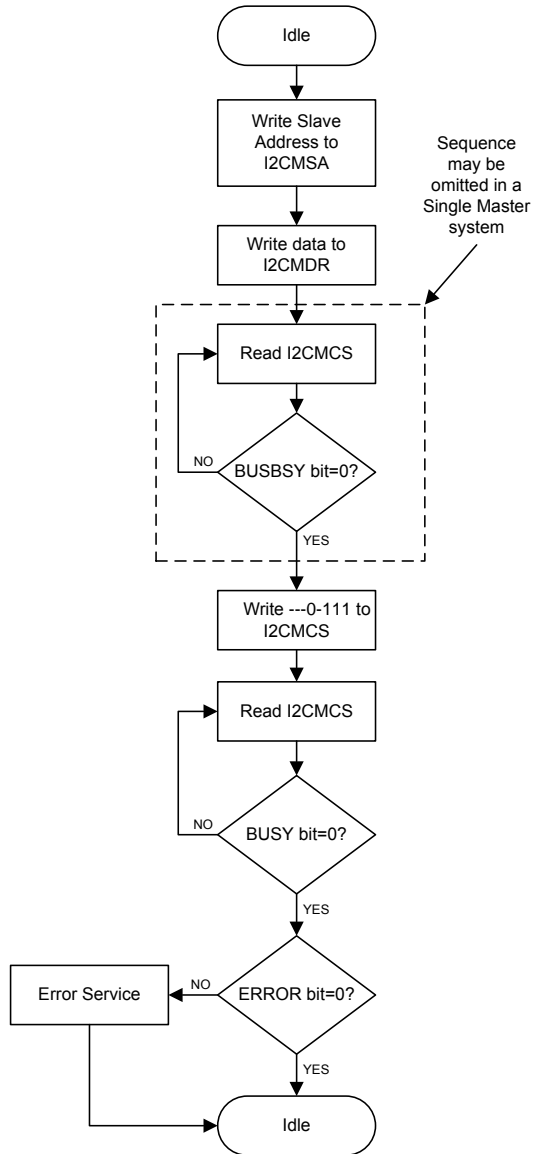


Figure 15-8. Master Single RECEIVE

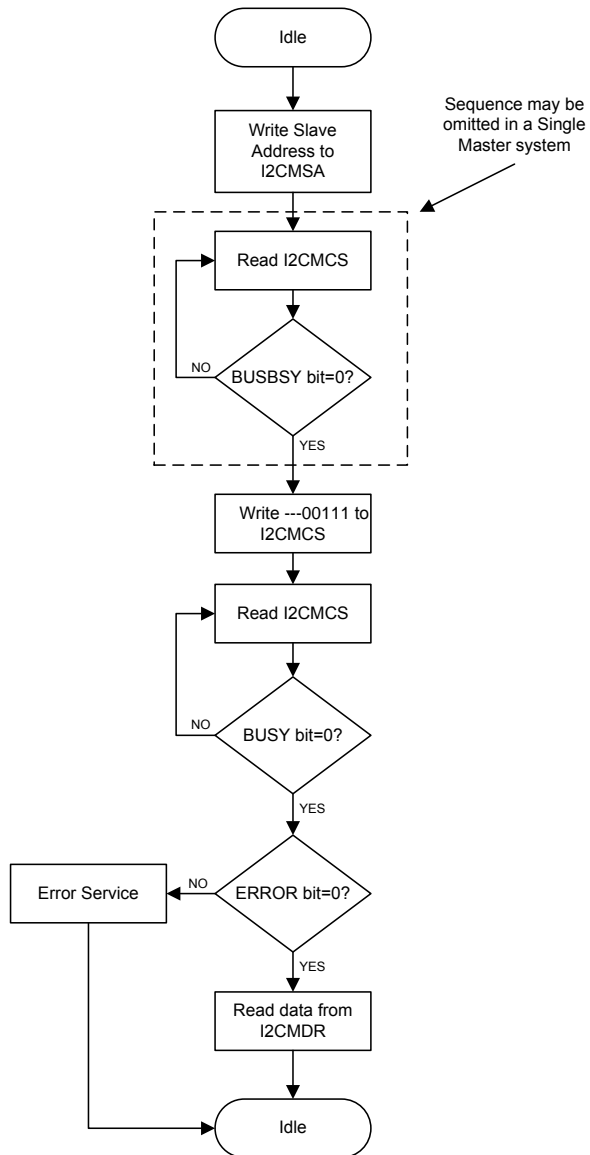


Figure 15-9. Master Burst SEND

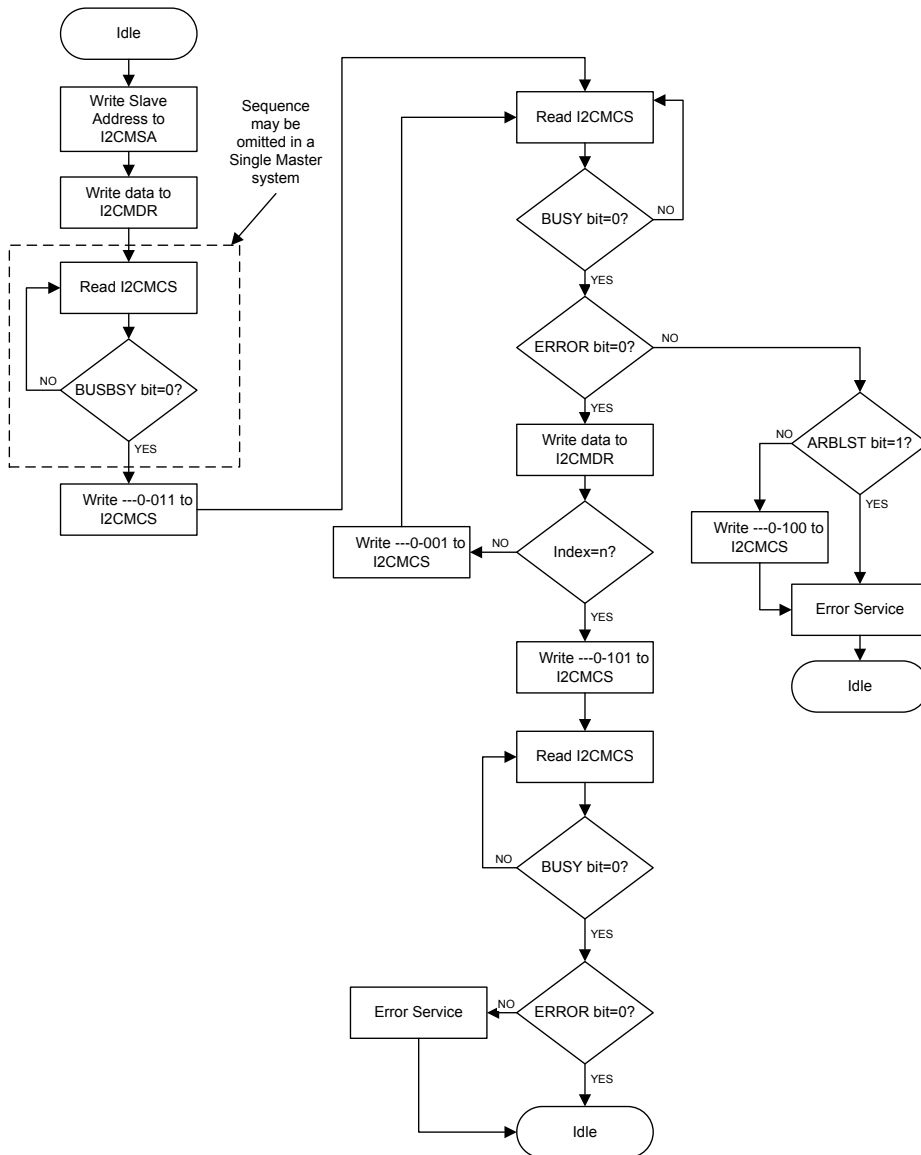


Figure 15-10. Master Burst RECEIVE

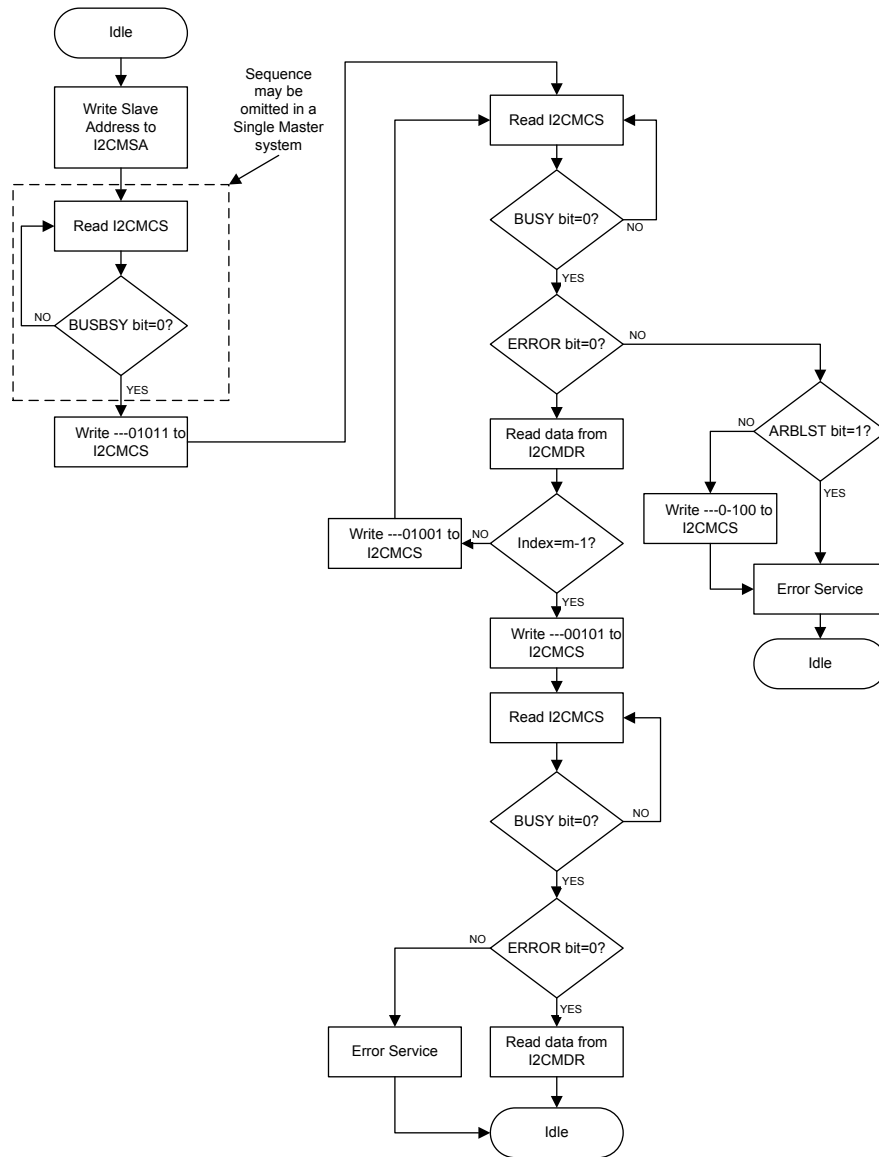




Figure 15-11. Master Burst RECEIVE after Burst SEND

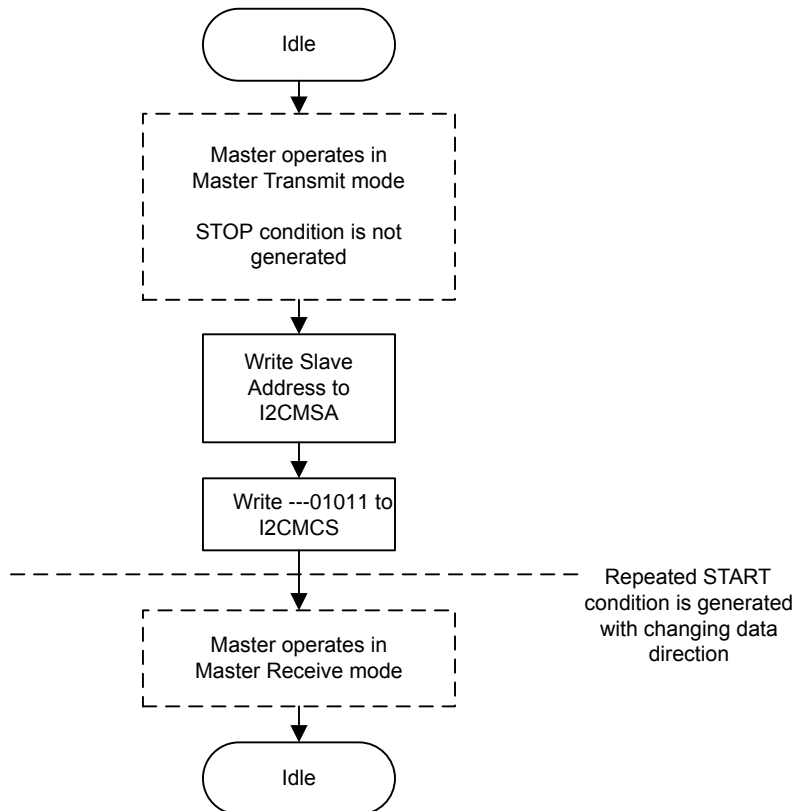
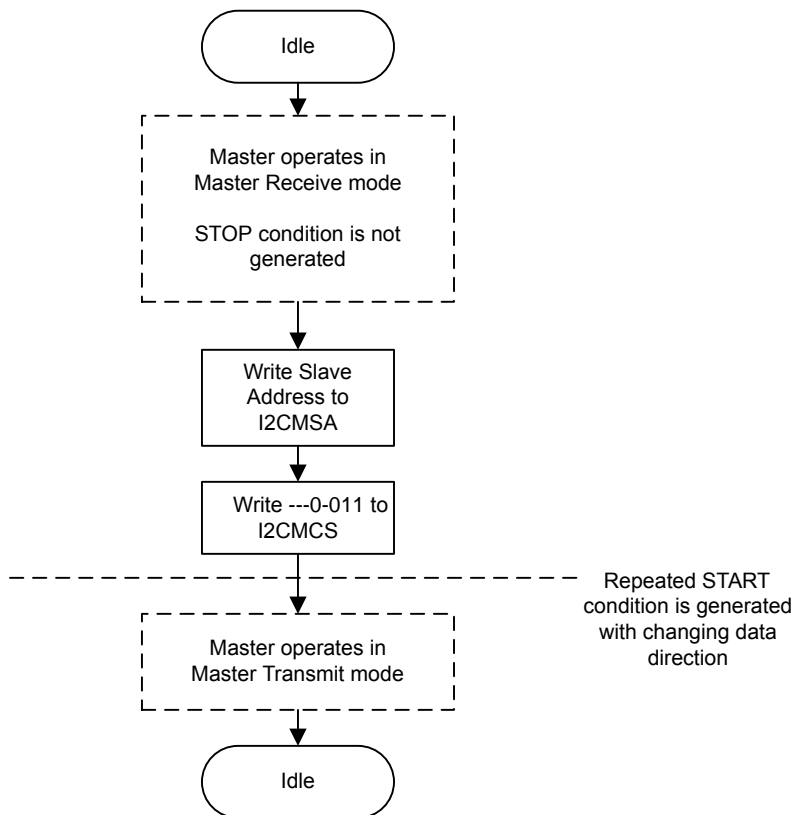


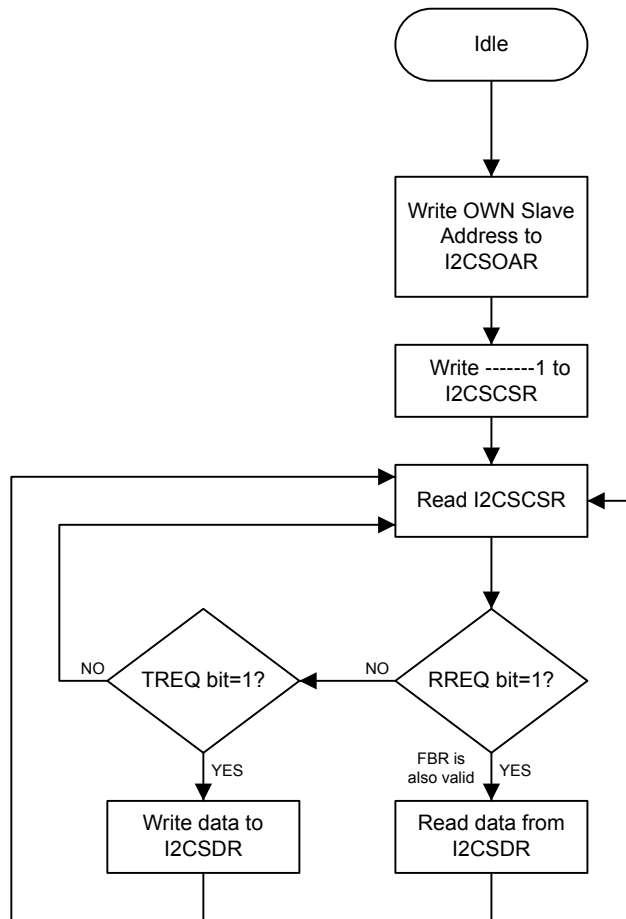
Figure 15-12. Master Burst SEND after Burst RECEIVE



### 15.2.5.2 I<sup>2</sup>C Slave Command Sequences

Figure 15-13 on page 379 presents the command sequence available for the I<sup>2</sup>C slave.

Figure 15-13. Slave Command Sequence



### 15.3 Initialization and Configuration

The following example shows how to configure the I<sup>2</sup>C module to send a single byte as a master. This assumes the system clock is 20 MHz.

1. Enable the I<sup>2</sup>C clock by writing a value of 0x0000.1000 to the **RCGC1** register in the System Control module.
2. Enable the clock to the appropriate GPIO module via the **RCGC2** register in the System Control module.
3. In the GPIO module, enable the appropriate pins for their alternate function using the **GPIOAFSEL** register. Also, be sure to enable the same pins for Open Drain operation.
4. Initialize the I<sup>2</sup>C Master by writing the **I2CMCR** register with a value of 0x0000.0020.
5. Set the desired SCL clock speed of 100 Kbps by writing the **I2CMTPR** register with the correct value. The value written to the **I2CMTPR** register represents the number of system clock periods in one SCL clock period. The TPR value is determined by the following equation:

```
TPR = (System Clock / (2 * (SCL_LP + SCL_HP) * SCL_CLK)) - 1;
TPR = (20MHz / (2 * (6 + 4) * 100000)) - 1;
TPR = 9
```

Write the **I2CMTPR** register with the value of 0x0000.0009.

6. Specify the slave address of the master and that the next operation will be a Send by writing the **I2CMSA** register with a value of 0x0000.0076. This sets the slave address to 0x3B.
7. Place data (byte) to be sent in the data register by writing the **I2CMDR** register with the desired data.
8. Initiate a single byte send of the data from Master to Slave by writing the **I2CMCS** register with a value of 0x0000.0007 (STOP, START, RUN).
9. Wait until the transmission completes by polling the **I2CMCS** register's BUSBSY bit until it has been cleared.

## 15.4 I<sup>2</sup>C Register Map

Table 15-2 on page 380 lists the I<sup>2</sup>C registers. All addresses given are relative to the I<sup>2</sup>C base addresses for the master and slave:

- I<sup>2</sup>C Master 0: 0x4002.0000
- I<sup>2</sup>C Slave 0: 0x4002.0800
- I<sup>2</sup>C Master 1: 0x4002.1000
- I<sup>2</sup>C Slave 1: 0x4002.1800

**Table 15-2. Inter-Integrated Circuit (I<sup>2</sup>C) Interface Register Map**

Offset	Name	Type	Reset	Description	See page
<b>I<sup>2</sup>C Master</b>					
0x000	I2CMSA	R/W	0x0000.0000	I2C Master Slave Address	382
0x004	I2CMCS	R/W	0x0000.0000	I2C Master Control/Status	383
0x008	I2CMDR	R/W	0x0000.0000	I2C Master Data	387
0x00C	I2CMTPR	R/W	0x0000.0001	I2C Master Timer Period	388
0x010	I2CMIMR	R/W	0x0000.0000	I2C Master Interrupt Mask	389
0x014	I2CMRIS	RO	0x0000.0000	I2C Master Raw Interrupt Status	390
0x018	I2CMMIS	RO	0x0000.0000	I2C Master Masked Interrupt Status	391
0x01C	I2CMICR	WO	0x0000.0000	I2C Master Interrupt Clear	392
0x020	I2CMCR	R/W	0x0000.0000	I2C Master Configuration	393
<b>I<sup>2</sup>C Slave</b>					
0x000	I2CSOAR	R/W	0x0000.0000	I2C Slave Own Address	395

Offset	Name	Type	Reset	Description	See page
0x004	I2CSCSR	RO	0x0000.0000	I2C Slave Control/Status	396
0x008	I2CSDR	R/W	0x0000.0000	I2C Slave Data	398
0x00C	I2CSIMR	R/W	0x0000.0000	I2C Slave Interrupt Mask	399
0x010	I2CSRIS	RO	0x0000.0000	I2C Slave Raw Interrupt Status	400
0x014	I2CSMIS	RO	0x0000.0000	I2C Slave Masked Interrupt Status	401
0x018	I2CSICR	WO	0x0000.0000	I2C Slave Interrupt Clear	402

## 15.5 Register Descriptions (I<sup>2</sup>C Master)

The remainder of this section lists and describes the I<sup>2</sup>C master registers, in numerical order by address offset. See also “Register Descriptions (I2C Slave)” on page 394.

### Register 1: I<sup>2</sup>C Master Slave Address (I2CMSA), offset 0x000

This register consists of eight bits: seven address bits (A6-A0), and a Receive/Send bit, which determines if the next operation is a Receive (High), or Send (Low).

#### I2C Master Slave Address (I2CMSA)

I2C Master 0 base: 0x4002.0000

I2C Master 1 base: 0x4002.1000

Offset 0x000

Type R/W, reset 0x0000.0000

	31	30	29	28	27	26	25	24	23	22	21	20	19	18	17	16
	reserved															
Type	RO	RO	RO	RO	RO	RO	RO	RO	RO	RO	RO	RO	RO	RO	RO	RO
Reset	0	0	0	0	0	0	0	0	0	0	0	0	0	0	0	0
	15	14	13	12	11	10	9	8	7	6	5	4	3	2	1	0
	reserved								SA							R/S
Type	RO	RO	RO	RO	RO	RO	RO	RO	R/W	R/W	R/W	R/W	R/W	R/W	R/W	R/W
Reset	0	0	0	0	0	0	0	0	0	0	0	0	0	0	0	0

Bit/Field	Name	Type	Reset	Description
31:8	reserved	RO	0x00	Software should not rely on the value of a reserved bit. To provide compatibility with future products, the value of a reserved bit should be preserved across a read-modify-write operation.
7:1	SA	R/W	0	I <sup>2</sup> C Slave Address  This field specifies bits A6 through A0 of the slave address.
0	R/S	R/W	0	Receive/Send  The R/S bit specifies if the next operation is a Receive (High) or Send (Low).  0: Send 1: Receive

## Register 2: I<sup>2</sup>C Master Control/Status (I2CMCS), offset 0x004

This register accesses four control bits when written, and accesses seven status bits when read.

The status register consists of seven bits, which when read determine the state of the I<sup>2</sup>C bus controller.

The control register consists of four bits: the RUN, START, STOP, and ACK bits. The START bit causes the generation of the START, or REPEATED START condition.

The STOP bit determines if the cycle stops at the end of the data cycle, or continues on to a burst. To generate a single send cycle, the I<sup>2</sup>C Master Slave Address (I2CMSA) register is written with the desired address, the R/S bit is set to 0, and the Control register is written with ACK=X (0 or 1), STOP=1, START=1, and RUN=1 to perform the operation and stop. When the operation is completed (or aborted due an error), the interrupt pin becomes active and the data may be read from the I2CMDR register. When the I<sup>2</sup>C module operates in Master receiver mode, the ACK bit must be set normally to logic 1. This causes the I<sup>2</sup>C bus controller to send an acknowledge automatically after each byte. This bit must be reset when the I<sup>2</sup>C bus controller requires no further data to be sent from the slave transmitter.

### Read-Only Status Register

#### I2C Master Control/Status (I2CMCS)

I2C Master 0 base: 0x4002.0000

I2C Master 1 base: 0x4002.1000

Offset 0x004

Type RO, reset 0x0000.0000

	31	30	29	28	27	26	25	24	23	22	21	20	19	18	17	16	
	reserved																
Type	RO	RO	RO	RO	RO	RO	RO	RO	RO	RO	RO	RO	RO	RO	RO	RO	
Reset	0	0	0	0	0	0	0	0	0	0	0	0	0	0	0	0	
	15	14	13	12	11	10	9	8	7	6	5	4	3	2	1	0	
	reserved										BUSBSY	IDLE	ARBLST	DATAACK	ADRACK	ERROR	BUSY
Type	RO	RO	RO	RO	RO	RO	RO	RO	RO	RO	RO	RO	RO	RO	RO	RO	
Reset	0	0	0	0	0	0	0	0	0	0	0	0	0	0	0	0	

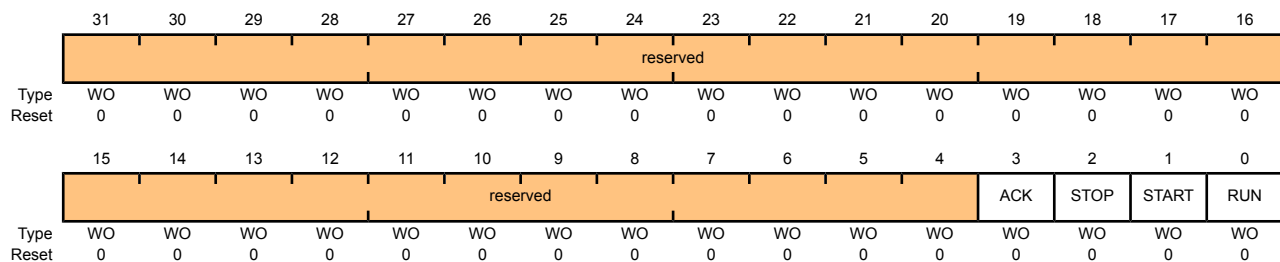
Bit/Field	Name	Type	Reset	Description
31:7	reserved	RO	0x00	Software should not rely on the value of a reserved bit. To provide compatibility with future products, the value of a reserved bit should be preserved across a read-modify-write operation.
6	BUSBSY	RO	0	Bus Busy  This bit specifies the state of the I <sup>2</sup> C bus. If set, the bus is busy; otherwise, the bus is idle. The bit changes based on the START and STOP conditions.
5	IDLE	RO	0	I <sup>2</sup> C Idle  This bit specifies the I <sup>2</sup> C controller state. If set, the controller is idle; otherwise the controller is not idle.
4	ARBLST	RO	0	Arbitration Lost  This bit specifies the result of bus arbitration. If set, the controller lost arbitration; otherwise, the controller won arbitration.

Bit/Field	Name	Type	Reset	Description
3	DATAACK	RO	0	Acknowledge Data  This bit specifies the result of the last data operation. If set, the transmitted data was not acknowledged; otherwise, the data was acknowledged.
2	ADRACK	RO	0	Acknowledge Address  This bit specifies the result of the last address operation. If set, the transmitted address was not acknowledged; otherwise, the address was acknowledged.
1	ERROR	RO	0	Error  This bit specifies the result of the last bus operation. If set, an error occurred on the last operation; otherwise, no error was detected. The error can be from the slave address not being acknowledged, the transmit data not being acknowledged, or because the controller lost arbitration.
0	BUSY	RO	0	I <sup>2</sup> C Busy  This bit specifies the state of the controller. If set, the controller is busy; otherwise, the controller is idle. When the <code>BUSY</code> bit is set, the other status bits are not valid.

### Write-Only Control Register

#### I2C Master Control/Status (I2CMCS)

I2C Master 0 base: 0x4002.0000  
 I2C Master 1 base: 0x4002.1000  
 Offset 0x004  
 Type WO, reset 0x0000.0000



Bit/Field	Name	Type	Reset	Description
31:4	reserved	WO	0x00	Software should not rely on the value of a reserved bit. To provide compatibility with future products, the value of a reserved bit should be preserved across a read-modify-write operation.
3	ACK	WO	0	Data Acknowledge Enable  When set, causes received data byte to be acknowledged automatically by the master. See field decoding in Table 15-3 on page 385.
2	STOP	WO	0	Generate STOP  When set, causes the generation of the STOP condition. See field decoding in Table 15-3 on page 385.



Bit/Field	Name	Type	Reset	Description
1	START	WO	0	Generate START When set, causes the generation of a START or repeated START condition. See field decoding in Table 15-3 on page 385.
0	RUN	WO	0	I <sup>2</sup> C Master Enable When set, allows the master to send or receive data. See field decoding in Table 15-3 on page 385.

Table 15-3. Write Field Decoding for I2CMCS[3:0] Field (Sheet 1 of 3)

Current State	I2CMSA[0]	I2CMCS[3:0]				Description
	R/S	ACK	STOP	START	RUN	
Idle	0	X <sup>a</sup>	0	1	1	START condition followed by SEND (master goes to the Master Transmit state).
	0	X	1	1	1	START condition followed by a SEND and STOP condition (master remains in Idle state).
	1	0	0	1	1	START condition followed by RECEIVE operation with negative ACK (master goes to the Master Receive state).
	1	0	1	1	1	START condition followed by RECEIVE and STOP condition (master remains in Idle state).
	1	1	0	1	1	START condition followed by RECEIVE (master goes to the Master Receive state).
	1	1	1	1	1	Illegal.
	All other combinations not listed are non-operations.					
Master Transmit	X	X	0	0	1	SEND operation (master remains in Master Transmit state).
	X	X	1	0	0	STOP condition (master goes to Idle state).
	X	X	1	0	1	SEND followed by STOP condition (master goes to Idle state).
	0	X	0	1	1	Repeated START condition followed by a SEND (master remains in Master Transmit state).
	0	X	1	1	1	Repeated START condition followed by SEND and STOP condition (master goes to Idle state).
	1	0	0	1	1	Repeated START condition followed by a RECEIVE operation with a negative ACK (master goes to Master Receive state).
	1	0	1	1	1	Repeated START condition followed by a SEND and STOP condition (master goes to Idle state).
	1	1	0	1	1	Repeated START condition followed by RECEIVE (master goes to Master Receive state).
	1	1	1	1	1	Illegal.
	All other combinations not listed are non-operations.					

Current State	I2CMSA[0]	I2CMCS[3:0]				Description
	R/S	ACK	STOP	START	RUN	
Master Receive	X	0	0	0	1	RECEIVE operation with negative ACK (master remains in Master Receive state).
	X	X	1	0	0	STOP condition (master goes to Idle state). <sup>b</sup>
	X	0	1	0	1	RECEIVE followed by STOP condition (master goes to Idle state).
	X	1	0	0	1	RECEIVE operation (master remains in Master Receive state).
	X	1	1	0	1	Illegal.
	1	0	0	1	1	Repeated START condition followed by RECEIVE operation with a negative ACK (master remains in Master Receive state).
	1	0	1	1	1	Repeated START condition followed by RECEIVE and STOP condition (master goes to Idle state).
	1	1	0	1	1	Repeated START condition followed by RECEIVE (master remains in Master Receive state).
	0	X	0	1	1	Repeated START condition followed by SEND (master goes to Master Transmit state).
	0	X	1	1	1	Repeated START condition followed by SEND and STOP condition (master goes to Idle state).
All other combinations not listed are non-operations.						NOP.

a. An X in a table cell indicates the bit can be 0 or 1.

b. In Master Receive mode, a STOP condition should be generated only after a Data Negative Acknowledge executed by the master or an Address Negative Acknowledge executed by the slave.

### Register 3: I<sup>2</sup>C Master Data (I2CMDR), offset 0x008

This register contains the data to be transmitted when in the Master Transmit state, and the data received when in the Master Receive state.

#### I2C Master Data (I2CMDR)

I2C Master 0 base: 0x4002.0000

I2C Master 1 base: 0x4002.1000

Offset 0x008

Type R/W, reset 0x0000.0000

	31	30	29	28	27	26	25	24	23	22	21	20	19	18	17	16
	reserved															
Type	RO	RO	RO	RO	RO	RO	RO	RO	RO	RO	RO	RO	RO	RO	RO	RO
Reset	0	0	0	0	0	0	0	0	0	0	0	0	0	0	0	0
	15	14	13	12	11	10	9	8	7	6	5	4	3	2	1	0
	reserved								DATA							
Type	RO	RO	RO	RO	RO	RO	RO	RO	R/W	R/W	R/W	R/W	R/W	R/W	R/W	R/W
Reset	0	0	0	0	0	0	0	0	0	0	0	0	0	0	0	0

Bit/Field	Name	Type	Reset	Description
31:8	reserved	RO	0x00	Software should not rely on the value of a reserved bit. To provide compatibility with future products, the value of a reserved bit should be preserved across a read-modify-write operation.
7:0	DATA	R/W	0x00	Data Transferred Data transferred during transaction.

## Register 4: I<sup>2</sup>C Master Timer Period (I2CMTPR), offset 0x00C

This register specifies the period of the SCL clock.

### I2C Master Timer Period (I2CMTPR)

I2C Master 0 base: 0x4002.0000

I2C Master 1 base: 0x4002.1000

Offset 0x00C

Type R/W, reset 0x0000.0001

	31	30	29	28	27	26	25	24	23	22	21	20	19	18	17	16
	reserved															
Type	RO	RO	RO	RO	RO	RO	RO	RO	RO	RO	RO	RO	RO	RO	RO	RO
Reset	0	0	0	0	0	0	0	0	0	0	0	0	0	0	0	0
	15	14	13	12	11	10	9	8	7	6	5	4	3	2	1	0
	reserved								TPR							
Type	RO	RO	RO	RO	RO	RO	RO	RO	R/W	R/W	R/W	R/W	R/W	R/W	R/W	R/W
Reset	0	0	0	0	0	0	0	0	0	0	0	0	0	0	0	1

Bit/Field	Name	Type	Reset	Description
31:8	reserved	RO	0x00	Software should not rely on the value of a reserved bit. To provide compatibility with future products, the value of a reserved bit should be preserved across a read-modify-write operation.
7:0	TPR	R/W	0x1	SCL Clock Period

This field specifies the period of the SCL clock.

$$SCL\_PRD = 2 * (1 + TPR) * (SCL\_LP + SCL\_HP) * CLK\_PRD$$

where:

SCL\_PRD is the SCL line period (I<sup>2</sup>C clock).

TPR is the Timer Period register value (range of 1 to 255).

SCL\_LP is the SCL Low period (fixed at 6).

SCL\_HP is the SCL High period (fixed at 4).

## Register 5: I<sup>2</sup>C Master Interrupt Mask (I2CMIMR), offset 0x010

This register controls whether a raw interrupt is promoted to a controller interrupt.

### I2C Master Interrupt Mask (I2CMIMR)

I2C Master 0 base: 0x4002.0000

I2C Master 1 base: 0x4002.1000

Offset 0x010

Type R/W, reset 0x0000.0000

	31	30	29	28	27	26	25	24	23	22	21	20	19	18	17	16
	reserved															
Type	RO	RO	RO	RO	RO	RO	RO	RO	RO	RO	RO	RO	RO	RO	RO	RO
Reset	0	0	0	0	0	0	0	0	0	0	0	0	0	0	0	0
	15	14	13	12	11	10	9	8	7	6	5	4	3	2	1	0
	reserved															IM
Type	RO	RO	RO	RO	RO	RO	RO	RO	RO	RO	RO	RO	RO	RO	RO	R/W
Reset	0	0	0	0	0	0	0	0	0	0	0	0	0	0	0	0

Bit/Field	Name	Type	Reset	Description
31:1	reserved	RO	0x00	Software should not rely on the value of a reserved bit. To provide compatibility with future products, the value of a reserved bit should be preserved across a read-modify-write operation.
0	IM	R/W	0	<p>Interrupt Mask</p> <p>This bit controls whether a raw interrupt is promoted to a controller interrupt. If set, the interrupt is not masked and the interrupt is promoted; otherwise, the interrupt is masked.</p>

## Register 6: I<sup>2</sup>C Master Raw Interrupt Status (I2CMRIS), offset 0x014

This register specifies whether an interrupt is pending.

### I2C Master Raw Interrupt Status (I2CMRIS)

I2C Master 0 base: 0x4002.0000

I2C Master 1 base: 0x4002.1000

Offset 0x014

Type RO, reset 0x0000.0000

	31	30	29	28	27	26	25	24	23	22	21	20	19	18	17	16
	reserved															
Type	RO	RO	RO	RO	RO	RO	RO	RO	RO	RO	RO	RO	RO	RO	RO	RO
Reset	0	0	0	0	0	0	0	0	0	0	0	0	0	0	0	0
	15	14	13	12	11	10	9	8	7	6	5	4	3	2	1	0
	reserved															RIS
Type	RO	RO	RO	RO	RO	RO	RO	RO	RO	RO	RO	RO	RO	RO	RO	RO
Reset	0	0	0	0	0	0	0	0	0	0	0	0	0	0	0	0

Bit/Field	Name	Type	Reset	Description
31:1	reserved	RO	0x00	Software should not rely on the value of a reserved bit. To provide compatibility with future products, the value of a reserved bit should be preserved across a read-modify-write operation.
0	RIS	RO	0	Raw Interrupt Status  This bit specifies the raw interrupt state (prior to masking) of the I <sup>2</sup> C master block. If set, an interrupt is pending; otherwise, an interrupt is not pending.

## Register 7: I<sup>2</sup>C Master Masked Interrupt Status (I2CMMIS), offset 0x018

This register specifies whether an interrupt was signaled.

### I2C Master Masked Interrupt Status (I2CMMIS)

I2C Master 0 base: 0x4002.0000

I2C Master 1 base: 0x4002.1000

Offset 0x018

Type RO, reset 0x0000.0000

	31	30	29	28	27	26	25	24	23	22	21	20	19	18	17	16
	reserved															
Type	RO	RO	RO	RO	RO	RO	RO	RO	RO	RO	RO	RO	RO	RO	RO	RO
Reset	0	0	0	0	0	0	0	0	0	0	0	0	0	0	0	0
	15	14	13	12	11	10	9	8	7	6	5	4	3	2	1	0
	reserved															
Type	RO	RO	RO	RO	RO	RO	RO	RO	RO	RO	RO	RO	RO	RO	RO	RO
Reset	0	0	0	0	0	0	0	0	0	0	0	0	0	0	0	0

Bit/Field	Name	Type	Reset	Description
31:1	reserved	RO	0x00	Software should not rely on the value of a reserved bit. To provide compatibility with future products, the value of a reserved bit should be preserved across a read-modify-write operation.
0	MIS	RO	0	Masked Interrupt Status  This bit specifies the raw interrupt state (after masking) of the I <sup>2</sup> C master block. If set, an interrupt was signaled; otherwise, an interrupt has not been generated since the bit was last cleared.

## Register 8: I<sup>2</sup>C Master Interrupt Clear (I2CMICR), offset 0x01C

This register clears the raw interrupt.

### I2C Master Interrupt Clear (I2CMICR)

I2C Master 0 base: 0x4002.0000

I2C Master 1 base: 0x4002.1000

Offset 0x01C

Type WO, reset 0x0000.0000

	31	30	29	28	27	26	25	24	23	22	21	20	19	18	17	16	
	reserved																
Type	RO	RO	RO	RO	RO	RO	RO	RO	RO	RO	RO	RO	RO	RO	RO	RO	
Reset	0	0	0	0	0	0	0	0	0	0	0	0	0	0	0	0	
	15	14	13	12	11	10	9	8	7	6	5	4	3	2	1	0	
	reserved															IC	
Type	RO	RO	RO	RO	RO	RO	RO	RO	RO	RO	RO	RO	RO	RO	RO	RO	WO
Reset	0	0	0	0	0	0	0	0	0	0	0	0	0	0	0	0	0

Bit/Field	Name	Type	Reset	Description
31:1	reserved	RO	0x00	Software should not rely on the value of a reserved bit. To provide compatibility with future products, the value of a reserved bit should be preserved across a read-modify-write operation.
0	IC	WO	0	Interrupt Clear  This bit controls the clearing of the raw interrupt. A write of 1 clears the interrupt; otherwise, a write of 0 has no affect on the interrupt state. A read of this register returns no meaningful data.



## Register 9: I<sup>2</sup>C Master Configuration (I2CMCR), offset 0x020

This register configures the mode (Master or Slave) and sets the interface for test mode loopback.

### I2C Master Configuration (I2CMCR)

I2C Master 0 base: 0x4002.0000

I2C Master 1 base: 0x4002.1000

Offset 0x020

Type R/W, reset 0x0000.0000

	31	30	29	28	27	26	25	24	23	22	21	20	19	18	17	16	
	reserved																
Type	RO	RO	RO	RO	RO	RO	RO	RO	RO	RO	RO	RO	RO	RO	RO	RO	
Reset	0	0	0	0	0	0	0	0	0	0	0	0	0	0	0	0	
	15	14	13	12	11	10	9	8	7	6	5	4	3	2	1	0	
	reserved											SFE	MFE	reserved		LPBK	
Type	RO	RO	RO	RO	RO	RO	RO	RO	RO	RO	RO	R/W	R/W	RO	RO	RO	R/W
Reset	0	0	0	0	0	0	0	0	0	0	0	0	0	0	0	0	0

Bit/Field	Name	Type	Reset	Description
31:6	reserved	RO	0x00	Software should not rely on the value of a reserved bit. To provide compatibility with future products, the value of a reserved bit should be preserved across a read-modify-write operation.
5	SFE	R/W	0	I <sup>2</sup> C Slave Function Enable  This bit specifies whether the interface may operate in Slave mode. If set, Slave mode is enabled; otherwise, Slave mode is disabled.
4	MFE	R/W	0	I <sup>2</sup> C Master Function Enable  This bit specifies whether the interface may operate in Master mode. If set, Master mode is enabled; otherwise, Master mode is disabled and the interface clock is disabled.
3:1	reserved	RO	0x00	Software should not rely on the value of a reserved bit. To provide compatibility with future products, the value of a reserved bit should be preserved across a read-modify-write operation.
0	LPBK	R/W	0	I <sup>2</sup> C Loopback  This bit specifies whether the interface is operating normally or in Loopback mode. If set, the device is put in a test mode loopback configuration; otherwise, the device operates normally.

## **15.6 Register Descriptions (I<sup>2</sup>C Slave)**

The remainder of this section lists and describes the I<sup>2</sup>C slave registers, in numerical order by address offset. See also “Register Descriptions (I<sup>2</sup>C Master)” on page 381.

## Register 10: I<sup>2</sup>C Slave Own Address (I2CSOAR), offset 0x000

This register consists of seven address bits that identify the Stellaris<sup>®</sup> I<sup>2</sup>C device on the I<sup>2</sup>C bus.

### I2C Slave Own Address (I2CSOAR)

I2C Slave 0 base: 0x4002.0800

I2C Slave 1 base: 0x4002.1800

Offset 0x000

Type R/W, reset 0x0000.0000

	31	30	29	28	27	26	25	24	23	22	21	20	19	18	17	16
	reserved															
Type	RO	RO	RO	RO	RO	RO	RO	RO	RO	RO	RO	RO	RO	RO	RO	RO
Reset	0	0	0	0	0	0	0	0	0	0	0	0	0	0	0	0
	15	14	13	12	11	10	9	8	7	6	5	4	3	2	1	0
	reserved									OAR						
Type	RO	RO	RO	RO	RO	RO	RO	RO	RO	R/W	R/W	R/W	R/W	R/W	R/W	R/W
Reset	0	0	0	0	0	0	0	0	0	0	0	0	0	0	0	0

Bit/Field	Name	Type	Reset	Description
31:7	reserved	RO	0x00	Software should not rely on the value of a reserved bit. To provide compatibility with future products, the value of a reserved bit should be preserved across a read-modify-write operation.
6:0	OAR	R/W	0x00	I <sup>2</sup> C Slave Own Address This field specifies bits A6 through A0 of the slave address.

## Register 11: I<sup>2</sup>C Slave Control/Status (I2CCSR), offset 0x004

This register accesses one control bit when written, and three status bits when read.

The read-only Status register consists of three bits: the **FBR**, **RREQ**, and **TREQ** bits. The **First Byte Received (FBR)** bit is set only after the Stellaris<sup>®</sup> device detects its own slave address and receives the first data byte from the I<sup>2</sup>C master. The **Receive Request (RREQ)** bit indicates that the Stellaris<sup>®</sup> I<sup>2</sup>C device has received a data byte from an I<sup>2</sup>C master. Read one data byte from the **I<sup>2</sup>C Slave Data (I2CSDR)** register to clear the RREQ bit. The **Transmit Request (TREQ)** bit indicates that the Stellaris<sup>®</sup> I<sup>2</sup>C device is addressed as a Slave Transmitter. Write one data byte into the **I<sup>2</sup>C Slave Data (I2CSDR)** register to clear the TREQ bit.

The write-only Control register consists of one bit: the **DA** bit. The DA bit enables and disables the Stellaris<sup>®</sup> I<sup>2</sup>C slave operation.

### Read-Only Status Register

#### I2C Slave Control/Status (I2CCSR)

I2C Slave 0 base: 0x4002.0800

I2C Slave 1 base: 0x4002.1800

Offset 0x004

Type RO, reset 0x0000.0000

	31	30	29	28	27	26	25	24	23	22	21	20	19	18	17	16
	reserved															
Type	RO	RO	RO	RO	RO	RO	RO	RO	RO	RO	RO	RO	RO	RO	RO	RO
Reset	0	0	0	0	0	0	0	0	0	0	0	0	0	0	0	0
	15	14	13	12	11	10	9	8	7	6	5	4	3	2	1	0
	reserved													FBR	TREQ	RREQ
Type	RO	RO	RO	RO	RO	RO	RO	RO	RO	RO	RO	RO	RO	RO	RO	RO
Reset	0	0	0	0	0	0	0	0	0	0	0	0	0	0	0	0

Bit/Field	Name	Type	Reset	Description
31:3	reserved	RO	0x00	Software should not rely on the value of a reserved bit. To provide compatibility with future products, the value of a reserved bit should be preserved across a read-modify-write operation.
2	FBR	RO	0	<p>First Byte Received</p> <p>Indicates that the first byte following the slave's own address is received. This bit is only valid when the RREQ bit is set, and is automatically cleared when data has been read from the I2CSDR register.</p> <p><b>Note:</b> This bit is not used for slave transmit operations.</p>
1	TREQ	RO	0	<p>Transmit Request</p> <p>This bit specifies the state of the I<sup>2</sup>C slave with regards to outstanding transmit requests. If set, the I<sup>2</sup>C unit has been addressed as a slave transmitter and uses clock stretching to delay the master until data has been written to the I2CSDR register. Otherwise, there is no outstanding transmit request.</p>
0	RREQ	RO	0	<p>Receive Request</p> <p>This bit specifies the status of the I<sup>2</sup>C slave with regards to outstanding receive requests. If set, the I<sup>2</sup>C unit has outstanding receive data from the I<sup>2</sup>C master and uses clock stretching to delay the master until the data has been read from the I2CSDR register. Otherwise, no receive data is outstanding.</p>

## Write-Only Control Register

### I2C Slave Control/Status (I2CSCSR)

I2C Slave 0 base: 0x4002.0800

I2C Slave 1 base: 0x4002.1800

Offset 0x004

Type WO, reset 0x0000.0000

	31	30	29	28	27	26	25	24	23	22	21	20	19	18	17	16	
	reserved																
Type	RO	RO	RO	RO	RO	RO	RO	RO	RO	RO	RO	RO	RO	RO	RO	RO	
Reset	0	0	0	0	0	0	0	0	0	0	0	0	0	0	0	0	
	15	14	13	12	11	10	9	8	7	6	5	4	3	2	1	0	
	reserved															DA	
Type	RO	RO	RO	RO	RO	RO	RO	RO	RO	RO	RO	RO	RO	RO	RO	RO	WO
Reset	0	0	0	0	0	0	0	0	0	0	0	0	0	0	0	0	0

Bit/Field	Name	Type	Reset	Description
31:1	reserved	RO	0x00	Software should not rely on the value of a reserved bit. To provide compatibility with future products, the value of a reserved bit should be preserved across a read-modify-write operation.
0	DA	WO	0	Device Active 1=Enables the I <sup>2</sup> C slave operation. 0=Disables the I <sup>2</sup> C slave operation.

### Register 12: I<sup>2</sup>C Slave Data (I2CSDR), offset 0x008

This register contains the data to be transmitted when in the Slave Transmit state, and the data received when in the Slave Receive state.

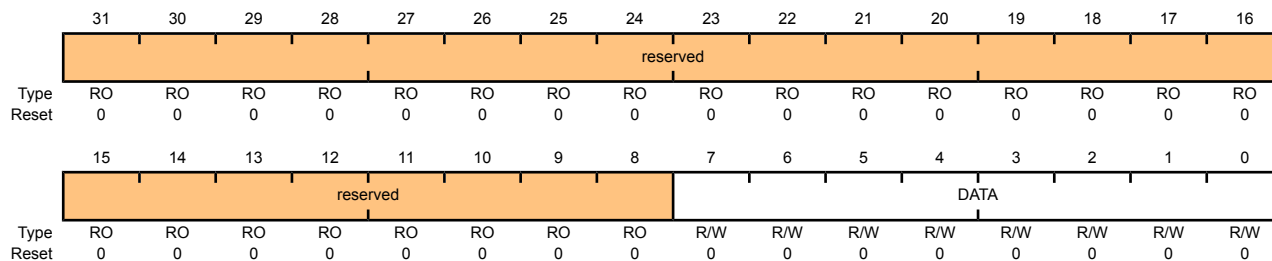
#### I2C Slave Data (I2CSDR)

I2C Slave 0 base: 0x4002.0800

I2C Slave 1 base: 0x4002.1800

Offset 0x008

Type R/W, reset 0x0000.0000



Bit/Field	Name	Type	Reset	Description
31:8	reserved	RO	0x00	Software should not rely on the value of a reserved bit. To provide compatibility with future products, the value of a reserved bit should be preserved across a read-modify-write operation.
7:0	DATA	R/W	0x0	Data for Transfer  This field contains the data for transfer during a slave receive or transmit operation.

## Register 13: I<sup>2</sup>C Slave Interrupt Mask (I2CSIMR), offset 0x00C

This register controls whether a raw interrupt is promoted to a controller interrupt.

### I2C Slave Interrupt Mask (I2CSIMR)

I2C Slave 0 base: 0x4002.0800

I2C Slave 1 base: 0x4002.1800

Offset 0x00C

Type R/W, reset 0x0000.0000

	31	30	29	28	27	26	25	24	23	22	21	20	19	18	17	16
	reserved															
Type	RO	RO	RO	RO	RO	RO	RO	RO	RO	RO	RO	RO	RO	RO	RO	RO
Reset	0	0	0	0	0	0	0	0	0	0	0	0	0	0	0	0
	15	14	13	12	11	10	9	8	7	6	5	4	3	2	1	0
	reserved															IM
Type	RO	RO	RO	RO	RO	RO	RO	RO	RO	RO	RO	RO	RO	RO	RO	R/W
Reset	0	0	0	0	0	0	0	0	0	0	0	0	0	0	0	0

Bit/Field	Name	Type	Reset	Description
31:1	reserved	RO	0x00	Software should not rely on the value of a reserved bit. To provide compatibility with future products, the value of a reserved bit should be preserved across a read-modify-write operation.
0	IM	R/W	0	<p>Interrupt Mask</p> <p>This bit controls whether a raw interrupt is promoted to a controller interrupt. If set, the interrupt is not masked and the interrupt is promoted; otherwise, the interrupt is masked.</p>

## Register 14: I<sup>2</sup>C Slave Raw Interrupt Status (I2CSRIS), offset 0x010

This register specifies whether an interrupt is pending.

### I2C Slave Raw Interrupt Status (I2CSRIS)

I2C Slave 0 base: 0x4002.0800

I2C Slave 1 base: 0x4002.1800

Offset 0x010

Type RO, reset 0x0000.0000

	31	30	29	28	27	26	25	24	23	22	21	20	19	18	17	16
	reserved															
Type	RO	RO	RO	RO	RO	RO	RO	RO	RO	RO	RO	RO	RO	RO	RO	RO
Reset	0	0	0	0	0	0	0	0	0	0	0	0	0	0	0	0
	15	14	13	12	11	10	9	8	7	6	5	4	3	2	1	0
	reserved															RIS
Type	RO	RO	RO	RO	RO	RO	RO	RO	RO	RO	RO	RO	RO	RO	RO	RO
Reset	0	0	0	0	0	0	0	0	0	0	0	0	0	0	0	0

Bit/Field	Name	Type	Reset	Description
31:1	reserved	RO	0x00	Software should not rely on the value of a reserved bit. To provide compatibility with future products, the value of a reserved bit should be preserved across a read-modify-write operation.
0	RIS	RO	0	Raw Interrupt Status  This bit specifies the raw interrupt state (prior to masking) of the I <sup>2</sup> C slave block. If set, an interrupt is pending; otherwise, an interrupt is not pending.



## Register 15: I<sup>2</sup>C Slave Masked Interrupt Status (I2CSMIS), offset 0x014

This register specifies whether an interrupt was signaled.

### I2C Slave Masked Interrupt Status (I2CSMIS)

I2C Slave 0 base: 0x4002.0800

I2C Slave 1 base: 0x4002.1800

Offset 0x014

Type RO, reset 0x0000.0000

	31	30	29	28	27	26	25	24	23	22	21	20	19	18	17	16
	reserved															
Type	RO	RO	RO	RO	RO	RO	RO	RO	RO	RO	RO	RO	RO	RO	RO	RO
Reset	0	0	0	0	0	0	0	0	0	0	0	0	0	0	0	0
	15	14	13	12	11	10	9	8	7	6	5	4	3	2	1	0
	reserved															MIS
Type	RO	RO	RO	RO	RO	RO	RO	RO	RO	RO	RO	RO	RO	RO	RO	RO
Reset	0	0	0	0	0	0	0	0	0	0	0	0	0	0	0	0

Bit/Field	Name	Type	Reset	Description
31:1	reserved	RO	0x00	Software should not rely on the value of a reserved bit. To provide compatibility with future products, the value of a reserved bit should be preserved across a read-modify-write operation.
0	MIS	RO	0	Masked Interrupt Status  This bit specifies the raw interrupt state (after masking) of the I <sup>2</sup> C slave block. If set, an interrupt was signaled; otherwise, an interrupt has not been generated since the bit was last cleared.

## Register 16: I<sup>2</sup>C Slave Interrupt Clear (I2CSICR), offset 0x018

This register clears the raw interrupt.

### I2C Slave Interrupt Clear (I2CSICR)

I2C Slave 0 base: 0x4002.0800

I2C Slave 1 base: 0x4002.1800

Offset 0x018

Type WO, reset 0x0000.0000

	31	30	29	28	27	26	25	24	23	22	21	20	19	18	17	16	
	reserved																
Type	RO	RO	RO	RO	RO	RO	RO	RO	RO	RO	RO	RO	RO	RO	RO	RO	
Reset	0	0	0	0	0	0	0	0	0	0	0	0	0	0	0	0	
	15	14	13	12	11	10	9	8	7	6	5	4	3	2	1	0	
	reserved															IC	
Type	RO	RO	RO	RO	RO	RO	RO	RO	RO	RO	RO	RO	RO	RO	RO	RO	WO
Reset	0	0	0	0	0	0	0	0	0	0	0	0	0	0	0	0	0

Bit/Field	Name	Type	Reset	Description
31:1	reserved	RO	0x00	Software should not rely on the value of a reserved bit. To provide compatibility with future products, the value of a reserved bit should be preserved across a read-modify-write operation.
0	IC	WO	0	Clear Interrupt  This bit controls the clearing of the raw interrupt. A write of 1 clears the interrupt; otherwise a write of 0 has no affect on the interrupt state. A read of this register returns no meaningful data.

## 16 Analog Comparators

An analog comparator is a peripheral that compares two analog voltages, and provides a logical output that signals the comparison result.

The LM3S1138 controller provides three independent integrated analog comparators that can be configured to drive an output or generate an interrupt or ADC event.

**Note:** Not all comparators have the option to drive an output pin. See the Comparator Operating Mode tables for more information.

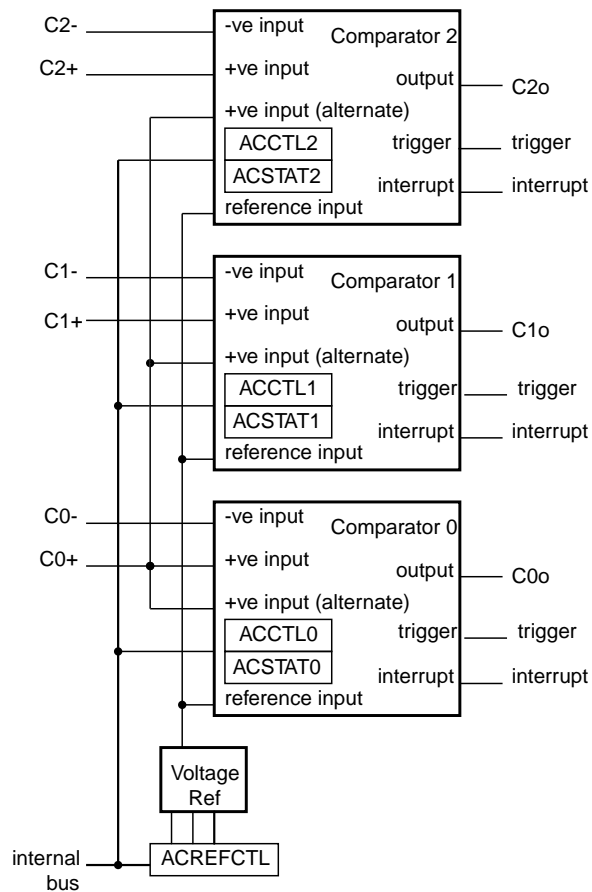
A comparator can compare a test voltage against any one of these voltages:

- An individual external reference voltage
- A shared single external reference voltage
- A shared internal reference voltage

The comparator can provide its output to a device pin, acting as a replacement for an analog comparator on the board, or it can be used to signal the application via interrupts or triggers to the ADC to cause it to start capturing a sample sequence. The interrupt generation and ADC triggering logic is separate. This means, for example, that an interrupt can be generated on a rising edge and the ADC triggered on a falling edge.

## 16.1 Block Diagram

Figure 16-1. Analog Comparator Module Block Diagram



## 16.2 Functional Description

**Important:** It is recommended that the Digital-Input enable (the `GPIOEN` bit in the GPIO module) for the analog input pin be disabled to prevent excessive current draw from the I/O pads.

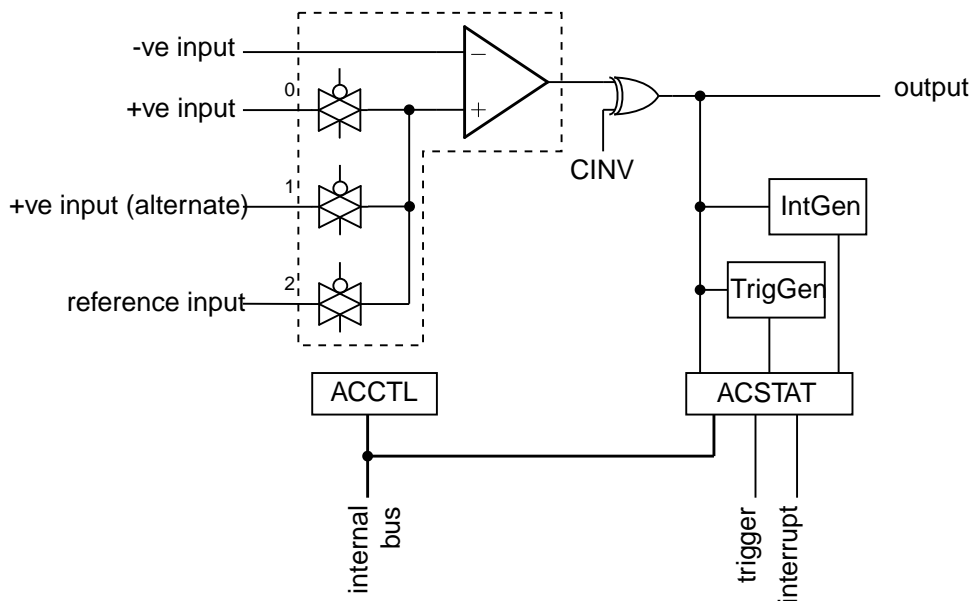
The comparator compares the  $V_{IN-}$  and  $V_{IN+}$  inputs to produce an output,  $V_{OUT}$ .

$$V_{IN-} < V_{IN+}, V_{OUT} = 1$$

$$V_{IN-} > V_{IN+}, V_{OUT} = 0$$

As shown in Figure 16-2 on page 405, the input source for  $V_{IN-}$  is an external input. In addition to an external input, input sources for  $V_{IN+}$  can be the +ve input of comparator 0 or an internal reference.

Figure 16-2. Structure of Comparator Unit



A comparator is configured through two status/control registers (**ACCTL** and **ACSTAT**). The internal reference is configured through one control register (**ACREFCTL**). Interrupt status and control is configured through three registers (**ACMIS**, **ACRIS**, and **ACINTEN**). The operating modes of the comparators are shown in the Comparator Operating Mode tables.

Typically, the comparator output is used internally to generate controller interrupts. It may also be used to drive an external pin or generate an analog-to-digital converter (ADC) trigger.

**Important:** Certain register bit values must be set before using the analog comparators. The proper pad configuration for the comparator input and output pins are described in the Comparator Operating Mode tables.

Table 16-1. Comparator 0 Operating Modes

ACCNTL0 Comparator 0					
ASRCP	VIN-	VIN+	Output	Interrupt	ADC Trigger
00	C0-	C0+	C0o	yes	yes
01	C0-	C0+	C0o	yes	yes
10	C0-	Vref	C0o	yes	yes
11	C0-	reserved	C0o	yes	yes

Table 16-2. Comparator 1 Operating Modes

ACCNTL1 Comparator 1					
ASRCP	VIN-	VIN+	Output	Interrupt	ADC Trigger
00	C1-	C1o/C1+ <sup>a</sup>	C1o/C1+	yes	yes
01	C1-	C0+	C1o/C1+	yes	yes
10	C1-	Vref	C1o/C1+	yes	yes
11	C1-	reserved	C1o/C1+	yes	yes

a. C1o and C1+ signals share a single pin and may only be used as one or the other.

**Table 16-3. Comparator 2 Operating Modes**

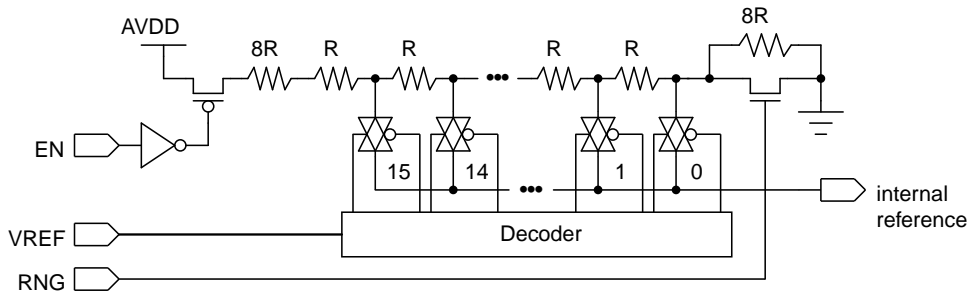
ACCNTL2	Comparator 2				
ASRCP	VIN-	VIN+	Output	Interrupt	ADC Trigger
00	C2-	C2o/C2+ <sup>a</sup>	C2o/C2+	yes	yes
01	C2-	C0+	C2o/C2+	yes	yes
10	C2-	Vref	C2o/C2+	yes	yes
11	C2-	reserved	C2o/C2+	yes	yes

a. C2o and C2+ signals share a single pin and may only be used as one or the other.

### 16.2.1 Internal Reference Programming

The structure of the internal reference is shown in Figure 16-3 on page 406. This is controlled by a single configuration register (**ACREFCTL**). Table 16-4 on page 406 shows the programming options to develop specific internal reference values, to compare an external voltage against a particular voltage generated internally.

**Figure 16-3. Comparator Internal Reference Structure**



**Table 16-4. Internal Reference Voltage and ACREFCTL Field Values**

ACREFCTL Register		Output Reference Voltage Based on VREF Field Value
EN Bit Value	RNG Bit Value	
EN=0	RNG=X	0 V (GND) for any value of VREF; however, it is recommended that RNG=1 and VREF=0 for the least noisy ground reference.

ACREFCTL Register		Output Reference Voltage Based on VREF Field Value
EN Bit Value	RNG Bit Value	
EN=1	RNG=0	<p>Total resistance in ladder is 32 R.</p> $V_{REF} = AV_{DD} \times \frac{R_{VREF}}{R_T}$ $V_{REF} = AV_{DD} \times \frac{(VREF + 8)}{32}$ $V_{REF} = 0.825 + 0.103 VREF$ <p>The range of internal reference in this mode is 0.825-2.37 V.</p>
	RNG=1	<p>Total resistance in ladder is 24 R.</p> $V_{REF} = AV_{DD} \times \frac{R_{VREF}}{R_T}$ $V_{REF} = AV_{DD} \times \frac{(VREF)}{24}$ $V_{REF} = 0.1375 \times VREF$ <p>The range of internal reference for this mode is 0.0-2.0625 V.</p>

## 16.3 Initialization and Configuration

The following example shows how to configure an analog comparator to read back its output value from an internal register.

1. Enable the analog comparator 0 clock by writing a value of 0x0010.0000 to the **RCGC1** register in the System Control module.
2. In the GPIO module, enable the GPIO port/pin associated with C0- as a GPIO input.
3. Configure the internal voltage reference to 1.65 V by writing the **ACREFCTL** register with the value 0x0000.030C.
4. Configure comparator 0 to use the internal voltage reference and to *not* invert the output on the C0o pin by writing the **ACCTL0** register with the value of 0x0000.040C.
5. Delay for some time.
6. Read the comparator output value by reading the **ACSTAT0** register's OVAL value.

Change the level of the signal input on C0- to see the OVAL value change.

## 16.4 Register Map

Table 16-5 on page 408 lists the comparator registers. The offset listed is a hexadecimal increment to the register's address, relative to the Analog Comparator base address of 0x4003.C000.

**Table 16-5. Analog Comparators Register Map**

Offset	Name	Type	Reset	Description	See page
0x00	ACMIS	R/W1C	0x0000.0000	Analog Comparator Masked Interrupt Status	409
0x04	ACRIS	RO	0x0000.0000	Analog Comparator Raw Interrupt Status	410
0x08	ACINTEN	R/W	0x0000.0000	Analog Comparator Interrupt Enable	411
0x10	ACREFCTL	R/W	0x0000.0000	Analog Comparator Reference Voltage Control	412
0x20	ACSTAT0	RO	0x0000.0000	Analog Comparator Status 0	413
0x24	ACCTL0	R/W	0x0000.0000	Analog Comparator Control 0	414
0x40	ACSTAT1	RO	0x0000.0000	Analog Comparator Status 1	413
0x44	ACCTL1	R/W	0x0000.0000	Analog Comparator Control 1	414
0x60	ACSTAT2	RO	0x0000.0000	Analog Comparator Status 2	413
0x64	ACCTL2	R/W	0x0000.0000	Analog Comparator Control 2	414

## 16.5 Register Descriptions

The remainder of this section lists and describes the Analog Comparator registers, in numerical order by address offset.



## Register 1: Analog Comparator Masked Interrupt Status (ACMIS), offset 0x00

This register provides a summary of the interrupt status (masked) of the comparator.

### Analog Comparator Masked Interrupt Status (ACMIS)

Base 0x4003.C000

Offset 0x00

Type R/W1C, reset 0x0000.0000

	31	30	29	28	27	26	25	24	23	22	21	20	19	18	17	16
	reserved															
Type	RO	RO	RO	RO	RO	RO	RO	RO	RO	RO	RO	RO	RO	RO	RO	RO
Reset	0	0	0	0	0	0	0	0	0	0	0	0	0	0	0	0
	15	14	13	12	11	10	9	8	7	6	5	4	3	2	1	0
	reserved													IN2	IN1	IN0
Type	RO	RO	RO	RO	RO	RO	RO	RO	RO	RO	RO	RO	RO	R/W1C	R/W1C	R/W1C
Reset	0	0	0	0	0	0	0	0	0	0	0	0	0	0	0	0

Bit/Field	Name	Type	Reset	Description
31:3	reserved	RO	0x00	Software should not rely on the value of a reserved bit. To provide compatibility with future products, the value of a reserved bit should be preserved across a read-modify-write operation.
2	IN2	R/W1C	0	Comparator 2 Masked Interrupt Status  Gives the masked interrupt state of this interrupt. Write 1 to this bit to clear the pending interrupt.
1	IN1	R/W1C	0	Comparator 1 Masked Interrupt Status  Gives the masked interrupt state of this interrupt. Write 1 to this bit to clear the pending interrupt.
0	IN0	R/W1C	0	Comparator 0 Masked Interrupt Status  Gives the masked interrupt state of this interrupt. Write 1 to this bit to clear the pending interrupt.

## Register 2: Analog Comparator Raw Interrupt Status (ACRIS), offset 0x04

This register provides a summary of the interrupt status (raw) of the comparator.

### Analog Comparator Raw Interrupt Status (ACRIS)

Base 0x4003.C000

Offset 0x04

Type RO, reset 0x0000.0000

	31	30	29	28	27	26	25	24	23	22	21	20	19	18	17	16
	reserved															
Type	RO	RO	RO	RO	RO	RO	RO	RO	RO	RO	RO	RO	RO	RO	RO	RO
Reset	0	0	0	0	0	0	0	0	0	0	0	0	0	0	0	0
	15	14	13	12	11	10	9	8	7	6	5	4	3	2	1	0
	reserved													IN2	IN1	IN0
Type	RO	RO	RO	RO	RO	RO	RO	RO	RO	RO	RO	RO	RO	RO	RO	RO
Reset	0	0	0	0	0	0	0	0	0	0	0	0	0	0	0	0

Bit/Field	Name	Type	Reset	Description
31:3	reserved	RO	0x00	Software should not rely on the value of a reserved bit. To provide compatibility with future products, the value of a reserved bit should be preserved across a read-modify-write operation.
2	IN2	RO	0	Comparator 2 Interrupt Status When set, indicates that an interrupt has been generated by comparator 2.
1	IN1	RO	0	Comparator 1 Interrupt Status When set, indicates that an interrupt has been generated by comparator 1.
0	IN0	RO	0	Comparator 0 Interrupt Status When set, indicates that an interrupt has been generated by comparator 0.

### Register 3: Analog Comparator Interrupt Enable (ACINTEN), offset 0x08

This register provides the interrupt enable for the comparator.

#### Analog Comparator Interrupt Enable (ACINTEN)

Base 0x4003.C000

Offset 0x08

Type R/W, reset 0x0000.0000

	31	30	29	28	27	26	25	24	23	22	21	20	19	18	17	16
	reserved															
Type	RO	RO	RO	RO	RO	RO	RO	RO	RO	RO	RO	RO	RO	RO	RO	RO
Reset	0	0	0	0	0	0	0	0	0	0	0	0	0	0	0	0
	15	14	13	12	11	10	9	8	7	6	5	4	3	2	1	0
	reserved													IN2	IN1	IN0
Type	RO	RO	RO	RO	RO	RO	RO	RO	RO	RO	RO	RO	RO	R/W	R/W	R/W
Reset	0	0	0	0	0	0	0	0	0	0	0	0	0	0	0	0

Bit/Field	Name	Type	Reset	Description
31:3	reserved	RO	0x00	Software should not rely on the value of a reserved bit. To provide compatibility with future products, the value of a reserved bit should be preserved across a read-modify-write operation.
2	IN2	R/W	0	Comparator 2 Interrupt Enable When set, enables the controller interrupt from the comparator 2 output
1	IN1	R/W	0	Comparator 1 Interrupt Enable When set, enables the controller interrupt from the comparator 1 output.
0	IN0	R/W	0	Comparator 0 Interrupt Enable When set, enables the controller interrupt from the comparator 0 output.

## Register 4: Analog Comparator Reference Voltage Control (ACREFCTL), offset 0x10

This register specifies whether the resistor ladder is powered on as well as the range and tap.

### Analog Comparator Reference Voltage Control (ACREFCTL)

Base 0x4003.C000

Offset 0x10

Type R/W, reset 0x0000.0000

	31	30	29	28	27	26	25	24	23	22	21	20	19	18	17	16
	reserved															
Type	RO	RO	RO	RO	RO	RO	RO	RO	RO	RO	RO	RO	RO	RO	RO	RO
Reset	0	0	0	0	0	0	0	0	0	0	0	0	0	0	0	0
	15	14	13	12	11	10	9	8	7	6	5	4	3	2	1	0
	reserved						EN	RNG	reserved				VREF			
Type	RO	RO	RO	RO	RO	RO	R/W	R/W	RO	RO	RO	RO	R/W	R/W	R/W	R/W
Reset	0	0	0	0	0	0	0	0	0	0	0	0	0	0	0	0

Bit/Field	Name	Type	Reset	Description
31:10	reserved	RO	0x00	Software should not rely on the value of a reserved bit. To provide compatibility with future products, the value of a reserved bit should be preserved across a read-modify-write operation.
9	EN	R/W	0	Resistor Ladder Enable  The <b>EN</b> bit specifies whether the resistor ladder is powered on. If 0, the resistor ladder is unpowered. If 1, the resistor ladder is connected to the analog $V_{DD}$ .  This bit is reset to 0 so that the internal reference consumes the least amount of power if not used and programmed.
8	RNG	R/W	0	Resistor Ladder Range  The <b>RNG</b> bit specifies the range of the resistor ladder. If 0, the resistor ladder has a total resistance of 32 R. If 1, the resistor ladder has a total resistance of 24 R.
7:4	reserved	RO	0x00	Software should not rely on the value of a reserved bit. To provide compatibility with future products, the value of a reserved bit should be preserved across a read-modify-write operation.
3:0	VREF	R/W	0x00	Resistor Ladder Voltage Ref  The <b>VREF</b> bit field specifies the resistor ladder tap that is passed through an analog multiplexer. The voltage corresponding to the tap position is the internal reference voltage available for comparison. See Table 16-4 on page 406 for some output reference voltage examples.

**Register 5: Analog Comparator Status 0 (ACSTAT0), offset 0x20****Register 6: Analog Comparator Status 1 (ACSTAT1), offset 0x40****Register 7: Analog Comparator Status 2 (ACSTAT2), offset 0x60**

These registers specify the current output value of the comparator.

**Analog Comparator Status 0 (ACSTAT0)**

Base 0x4003.C000

Offset 0x20

Type RO, reset 0x0000.0000

	31	30	29	28	27	26	25	24	23	22	21	20	19	18	17	16	
	reserved																
Type	RO	RO	RO	RO	RO	RO	RO	RO	RO	RO	RO	RO	RO	RO	RO	RO	
Reset	0	0	0	0	0	0	0	0	0	0	0	0	0	0	0	0	
	15	14	13	12	11	10	9	8	7	6	5	4	3	2	1	0	
	reserved															OVAL	reserved
Type	RO	RO	RO	RO	RO	RO	RO	RO	RO	RO	RO	RO	RO	RO	RO	RO	RO
Reset	0	0	0	0	0	0	0	0	0	0	0	0	0	0	0	0	0

Bit/Field	Name	Type	Reset	Description
31:2	reserved	RO	0x00	Software should not rely on the value of a reserved bit. To provide compatibility with future products, the value of a reserved bit should be preserved across a read-modify-write operation.
1	OVAL	RO	0	Comparator Output Value  The OVAL bit specifies the current output value of the comparator.
0	reserved	RO	0	Software should not rely on the value of a reserved bit. To provide compatibility with future products, the value of a reserved bit should be preserved across a read-modify-write operation.

**Register 8: Analog Comparator Control 0 (ACCTL0), offset 0x24**

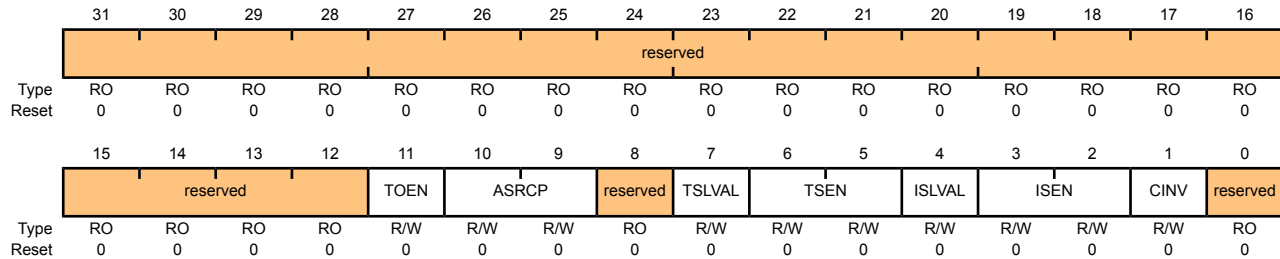
**Register 9: Analog Comparator Control 1 (ACCTL1), offset 0x44**

**Register 10: Analog Comparator Control 2 (ACCTL2), offset 0x64**

These registers configure the comparator's input and output.

Analog Comparator Control 0 (ACCTL0)

Base 0x4003.C000  
 Offset 0x24  
 Type R/W, reset 0x0000.0000



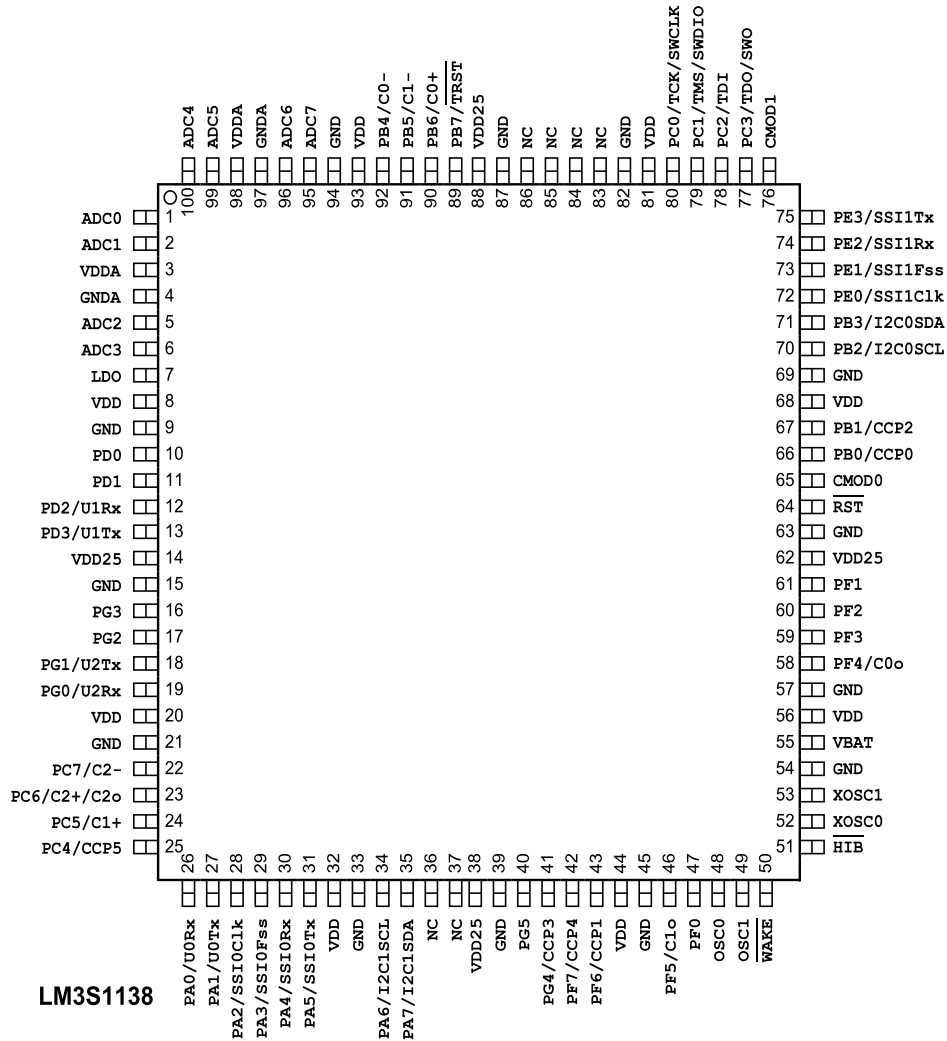
Bit/Field	Name	Type	Reset	Description										
31:12	reserved	RO	0x00	Software should not rely on the value of a reserved bit. To provide compatibility with future products, the value of a reserved bit should be preserved across a read-modify-write operation.										
11	TOEN	R/W	0	<p>Trigger Output Enable</p> <p>The <b>TOEN</b> bit enables the ADC event transmission to the ADC. If 0, the event is suppressed and not sent to the ADC. If 1, the event is transmitted to the ADC.</p>										
10:9	ASRCP	R/W	0x00	<p>Analog Source Positive</p> <p>The <b>ASRCP</b> field specifies the source of input voltage to the VIN+ terminal of the comparator. The encodings for this field are as follows:</p> <table border="0"> <tr> <td>Value</td> <td>Function</td> </tr> <tr> <td>0x0</td> <td>Pin value</td> </tr> <tr> <td>0x1</td> <td>Pin value of C0+</td> </tr> <tr> <td>0x2</td> <td>Internal voltage reference</td> </tr> <tr> <td>0x3</td> <td>Reserved</td> </tr> </table>	Value	Function	0x0	Pin value	0x1	Pin value of C0+	0x2	Internal voltage reference	0x3	Reserved
Value	Function													
0x0	Pin value													
0x1	Pin value of C0+													
0x2	Internal voltage reference													
0x3	Reserved													
8	reserved	RO	0	Software should not rely on the value of a reserved bit. To provide compatibility with future products, the value of a reserved bit should be preserved across a read-modify-write operation.										
7	TSLVAL	R/W	0	<p>Trigger Sense Level Value</p> <p>The <b>TSLVAL</b> bit specifies the sense value of the input that generates an ADC event if in Level Sense mode. If 0, an ADC event is generated if the comparator output is Low. Otherwise, an ADC event is generated if the comparator output is High.</p>										

Bit/Field	Name	Type	Reset	Description										
6:5	TSEN	R/W	0x0	<p>Trigger Sense</p> <p>The TSEN field specifies the sense of the comparator output that generates an ADC event. The sense conditioning is as follows:</p> <table border="1"> <thead> <tr> <th>Value</th> <th>Function</th> </tr> </thead> <tbody> <tr> <td>0x0</td> <td>Level sense, see TSLVAL</td> </tr> <tr> <td>0x1</td> <td>Falling edge</td> </tr> <tr> <td>0x2</td> <td>Rising edge</td> </tr> <tr> <td>0x3</td> <td>Either edge</td> </tr> </tbody> </table>	Value	Function	0x0	Level sense, see TSLVAL	0x1	Falling edge	0x2	Rising edge	0x3	Either edge
Value	Function													
0x0	Level sense, see TSLVAL													
0x1	Falling edge													
0x2	Rising edge													
0x3	Either edge													
4	ISLVAL	R/W	0	<p>Interrupt Sense Level Value</p> <p>The ISLVAL bit specifies the sense value of the input that generates an interrupt if in Level Sense mode. If 0, an interrupt is generated if the comparator output is Low. Otherwise, an interrupt is generated if the comparator output is High.</p>										
3:2	ISEN	R/W	0x0	<p>Interrupt Sense</p> <p>The ISEN field specifies the sense of the comparator output that generates an interrupt. The sense conditioning is as follows:</p> <table border="1"> <thead> <tr> <th>Value</th> <th>Function</th> </tr> </thead> <tbody> <tr> <td>0x0</td> <td>Level sense, see ISLVAL</td> </tr> <tr> <td>0x1</td> <td>Falling edge</td> </tr> <tr> <td>0x2</td> <td>Rising edge</td> </tr> <tr> <td>0x3</td> <td>Either edge</td> </tr> </tbody> </table>	Value	Function	0x0	Level sense, see ISLVAL	0x1	Falling edge	0x2	Rising edge	0x3	Either edge
Value	Function													
0x0	Level sense, see ISLVAL													
0x1	Falling edge													
0x2	Rising edge													
0x3	Either edge													
1	CINV	R/W	0	<p>Comparator Output Invert</p> <p>The CINV bit conditionally inverts the output of the comparator. If 0, the output of the comparator is unchanged. If 1, the output of the comparator is inverted prior to being processed by hardware.</p>										
0	reserved	RO	0	<p>Software should not rely on the value of a reserved bit. To provide compatibility with future products, the value of a reserved bit should be preserved across a read-modify-write operation.</p>										

# 17 Pin Diagram

Figure 17-1 on page 416 shows the pin diagram and pin-to-signal-name mapping.

**Figure 17-1. Pin Connection Diagram**





## 18 Signal Tables

The following tables list the signals available for each pin. Functionality is enabled by software with the **GPIOAFSEL** register.

**Important:** All multiplexed pins are GPIOs by default, with the exception of the five JTAG pins (PB7 and PC[3:0]) which default to the JTAG functionality.

Table 18-1 on page 417 shows the pin-to-signal-name mapping, including functional characteristics of the signals. Table 18-2 on page 421 lists the signals in alphabetical order by signal name.

Table 18-3 on page 425 groups the signals by functionality, except for GPIOs. Table 18-4 on page 429 lists the GPIO pins and their alternate functionality.

**Table 18-1. Signals by Pin Number**

Pin Number	Pin Name	Pin Type	Buffer Type	Description
1	ADC0	I	Analog	Analog-to-digital converter input 0.
2	ADC1	I	Analog	Analog-to-digital converter input 1.
3	VDDA	-	Power	The positive supply (3.3 V) for the analog circuits (ADC, Analog Comparators, etc.). These are separated from VDD to minimize the electrical noise contained on VDD from affecting the analog functions.
4	GNDA	-	Power	The ground reference for the analog circuits (ADC, Analog Comparators, etc.). These are separated from GND to minimize the electrical noise contained on VDD from affecting the analog functions.
5	ADC2	I	Analog	Analog-to-digital converter input 2.
6	ADC3	I	Analog	Analog-to-digital converter input 3.
7	LDO	-	Power	Low drop-out regulator output voltage. This pin requires an external capacitor between the pin and GND of 1 $\mu$ F or greater. When the on-chip LDO is used to provide power to the logic, the LDO pin must also be connected to the VDD25 pins at the board level in addition to the decoupling capacitor(s).
8	VDD	-	Power	Positive supply for I/O and some logic.
9	GND	-	Power	Ground reference for logic and I/O pins.
10	PD0	I/O	TTL	GPIO port D bit 0
11	PD1	I/O	TTL	GPIO port D bit 1
12	PD2	I/O	TTL	GPIO port D bit 2
	U1Rx	I	TTL	UART module 1 receive. When in IrDA mode, this signal has IrDA modulation.
13	PD3	I/O	TTL	GPIO port D bit 3
	U1Tx	O	TTL	UART module 1 transmit. When in IrDA mode, this signal has IrDA modulation.
14	VDD25	-	Power	Positive supply for most of the logic function, including the processor core and most peripherals.
15	GND	-	Power	Ground reference for logic and I/O pins.

Pin Number	Pin Name	Pin Type	Buffer Type	Description
16	PG3	I/O	TTL	GPIO port G bit 3
17	PG2	I/O	TTL	GPIO port G bit 2
18	PG1	I/O	TTL	GPIO port G bit 1
	U2Tx	O	TTL	UART 2 Transmit. When in IrDA mode, this signal has IrDA modulation.
19	PG0	I/O	TTL	GPIO port G bit 0
	U2Rx	I	TTL	UART 2 Receive. When in IrDA mode, this signal has IrDA modulation.
20	VDD	-	Power	Positive supply for I/O and some logic.
21	GND	-	Power	Ground reference for logic and I/O pins.
22	PC7	I/O	TTL	GPIO port C bit 7
	C2-	I	Analog	Analog comparator 2 negative input
23	PC6	I/O	TTL	GPIO port C bit 6
	C2+	I	Analog	Analog comparator positive input
	C2o	O	TTL	Analog comparator 2 output
24	PC5	I/O	TTL	GPIO port C bit 5
	C1+	I	Analog	Analog comparator positive input
25	PC4	I/O	TTL	GPIO port C bit 4
	CCP5	I/O	TTL	Capture/Compare/PWM 5
26	PA0	I/O	TTL	GPIO port A bit 0
	U0Rx	I	TTL	UART module 0 receive. When in IrDA mode, this signal has IrDA modulation.
27	PA1	I/O	TTL	GPIO port A bit 1
	U0Tx	O	TTL	UART module 0 transmit. When in IrDA mode, this signal has IrDA modulation.
28	PA2	I/O	TTL	GPIO port A bit 2
	SSI0Clk	I/O	TTL	SSI module 0 clock
29	PA3	I/O	TTL	GPIO port A bit 3
	SSI0Fss	I/O	TTL	SSI module 0 frame
30	PA4	I/O	TTL	GPIO port A bit 4
	SSI0Rx	I	TTL	SSI module 0 receive
31	PA5	I/O	TTL	GPIO port A bit 5
	SSI0Tx	O	TTL	SSI module 0 transmit
32	VDD	-	Power	Positive supply for I/O and some logic.
33	GND	-	Power	Ground reference for logic and I/O pins.
34	PA6	I/O	TTL	GPIO port A bit 6
	I2C1SCL	I/O	OD	I2C module 1 clock
35	PA7	I/O	TTL	GPIO port A bit 7
	I2C1SDA	I/O	OD	I2C module 1 data
36	NC	-	-	No connect
37	NC	-	-	No connect
38	VDD25	-	Power	Positive supply for most of the logic function, including the processor core and most peripherals.

Pin Number	Pin Name	Pin Type	Buffer Type	Description
39	GND	-	Power	Ground reference for logic and I/O pins.
40	PG5	I/O	TTL	GPIO port G bit 5
41	PG4	I/O	TTL	GPIO port G bit 4
	CCP3	I/O	TTL	Capture/Compare/PWM 3
42	PF7	I/O	TTL	GPIO port F bit 7
	CCP4	I/O	TTL	Capture/Compare/PWM 4
43	PF6	I/O	TTL	GPIO port F bit 6
	CCP1	I/O	TTL	Capture/Compare/PWM 1
44	VDD	-	Power	Positive supply for I/O and some logic.
45	GND	-	Power	Ground reference for logic and I/O pins.
46	PF5	I/O	TTL	GPIO port F bit 5
	C1o	O	TTL	Analog comparator 1 output
47	PF0	I/O	TTL	GPIO port F bit 0
48	OSC0	I	Analog	Main oscillator crystal input or an external clock reference input.
49	OSC1	O	Analog	Main oscillator crystal output.
50	$\overline{\text{WAKE}}$	I	OD	An external input that brings the processor out of hibernate mode when asserted.
51	$\overline{\text{HIB}}$	O	TTL	An output that indicates the processor is in hibernate mode.
52	XOSC0	I	Analog	Hibernation Module oscillator crystal input or an external clock reference input. Note that this is either a 4.19-MHz crystal or a 32.768-kHz oscillator for the Hibernation Module RTC. See the CLKSEL bit in the HIBCTL register.
53	XOSC1	O	Analog	Hibernation Module oscillator crystal output.
54	GND	-	Power	Ground reference for logic and I/O pins.
55	VBAT	-	Power	Power source for the Hibernation Module. It is normally connected to the positive terminal of a battery and serves as the battery backup/Hibernation Module power-source supply.
56	VDD	-	Power	Positive supply for I/O and some logic.
57	GND	-	Power	Ground reference for logic and I/O pins.
58	PF4	I/O	TTL	GPIO port F bit 4
	C0o	O	TTL	Analog comparator 0 output
59	PF3	I/O	TTL	GPIO port F bit 3
60	PF2	I/O	TTL	GPIO port F bit 2
61	PF1	I/O	TTL	GPIO port F bit 1
62	VDD25	-	Power	Positive supply for most of the logic function, including the processor core and most peripherals.
63	GND	-	Power	Ground reference for logic and I/O pins.
64	RST	I	TTL	System reset input.
65	CMOD0	I/O	TTL	CPU Mode bit 0. Input must be set to logic 0 (grounded); other encodings reserved.

Pin Number	Pin Name	Pin Type	Buffer Type	Description
66	PB0	I/O	TTL	GPIO port B bit 0
	CCP0	I/O	TTL	Capture/Compare/PWM 0
67	PB1	I/O	TTL	GPIO port B bit 1
	CCP2	I/O	TTL	Capture/Compare/PWM 2
68	VDD	-	Power	Positive supply for I/O and some logic.
69	GND	-	Power	Ground reference for logic and I/O pins.
70	PB2	I/O	TTL	GPIO port B bit 2
	I2C0SCL	I/O	OD	I2C module 0 clock
71	PB3	I/O	TTL	GPIO port B bit 3
	I2C0SDA	I/O	OD	I2C module 0 data
72	PE0	I/O	TTL	GPIO port E bit 0
	SSI1Clk	I/O	TTL	SSI module 1 clock
73	PE1	I/O	TTL	GPIO port E bit 1
	SSI1Fss	I/O	TTL	SSI module 1 frame
74	PE2	I/O	TTL	GPIO port E bit 2
	SSI1Rx	I	TTL	SSI module 1 receive
75	PE3	I/O	TTL	GPIO port E bit 3
	SSI1Tx	O	TTL	SSI module 1 transmit
76	CMOD1	I/O	TTL	CPU Mode bit 1. Input must be set to logic 0 (grounded); other encodings reserved.
77	PC3	I/O	TTL	GPIO port C bit 3
	TDO	O	TTL	JTAG TDO and SWO
	SWO	O	TTL	JTAG TDO and SWO
78	PC2	I/O	TTL	GPIO port C bit 2
	TDI	I	TTL	JTAG TDI
79	PC1	I/O	TTL	GPIO port C bit 1
	TMS	I/O	TTL	JTAG TMS and SWDIO
	SWDIO	I/O	TTL	JTAG TMS and SWDIO
80	PC0	I/O	TTL	GPIO port C bit 0
	TCK	I	TTL	JTAG/SWD CLK
	SWCLK	I	TTL	JTAG/SWD CLK
81	VDD	-	Power	Positive supply for I/O and some logic.
82	GND	-	Power	Ground reference for logic and I/O pins.
83	NC	-	-	No connect
84	NC	-	-	No connect
85	NC	-	-	No connect
86	NC	-	-	No connect
87	GND	-	Power	Ground reference for logic and I/O pins.
88	VDD25	-	Power	Positive supply for most of the logic function, including the processor core and most peripherals.
89	PB7	I/O	TTL	GPIO port B bit 7
	TRST	I	TTL	JTAG TRSTn

Pin Number	Pin Name	Pin Type	Buffer Type	Description
90	PB6	I/O	TTL	GPIO port B bit 6
	C0+	I	Analog	Analog comparator 0 positive input
91	PB5	I/O	TTL	GPIO port B bit 5
	C1-	I	Analog	Analog comparator 1 negative input
92	PB4	I/O	TTL	GPIO port B bit 4
	C0-	I	Analog	Analog comparator 0 negative input
93	VDD	-	Power	Positive supply for I/O and some logic.
94	GND	-	Power	Ground reference for logic and I/O pins.
95	ADC7	I	Analog	Analog-to-digital converter input 7.
96	ADC6	I	Analog	Analog-to-digital converter input 6.
97	GNDA	-	Power	The ground reference for the analog circuits (ADC, Analog Comparators, etc.). These are separated from GND to minimize the electrical noise contained on VDD from affecting the analog functions.
98	VDDA	-	Power	The positive supply (3.3 V) for the analog circuits (ADC, Analog Comparators, etc.). These are separated from VDD to minimize the electrical noise contained on VDD from affecting the analog functions.
99	ADC5	I	Analog	Analog-to-digital converter input 5.
100	ADC4	I	Analog	Analog-to-digital converter input 4.

Table 18-2. Signals by Signal Name

Pin Name	Pin Number	Pin Type	Buffer Type	Description
ADC0	1	I	Analog	Analog-to-digital converter input 0.
ADC1	2	I	Analog	Analog-to-digital converter input 1.
ADC2	5	I	Analog	Analog-to-digital converter input 2.
ADC3	6	I	Analog	Analog-to-digital converter input 3.
ADC4	100	I	Analog	Analog-to-digital converter input 4.
ADC5	99	I	Analog	Analog-to-digital converter input 5.
ADC6	96	I	Analog	Analog-to-digital converter input 6.
ADC7	95	I	Analog	Analog-to-digital converter input 7.
C0+	90	I	Analog	Analog comparator 0 positive input
C0-	92	I	Analog	Analog comparator 0 negative input
C0o	58	O	TTL	Analog comparator 0 output
C1+	24	I	Analog	Analog comparator positive input
C1-	91	I	Analog	Analog comparator 1 negative input
C1o	46	O	TTL	Analog comparator 1 output
C2+	23	I	Analog	Analog comparator positive input
C2-	22	I	Analog	Analog comparator 2 negative input
C2o	23	O	TTL	Analog comparator 2 output
CCP0	66	I/O	TTL	Capture/Compare/PWM 0
CCP1	43	I/O	TTL	Capture/Compare/PWM 1
CCP2	67	I/O	TTL	Capture/Compare/PWM 2

Pin Name	Pin Number	Pin Type	Buffer Type	Description
CCP3	41	I/O	TTL	Capture/Compare/PWM 3
CCP4	42	I/O	TTL	Capture/Compare/PWM 4
CCP5	25	I/O	TTL	Capture/Compare/PWM 5
CMOD0	65	I/O	TTL	CPU Mode bit 0. Input must be set to logic 0 (grounded); other encodings reserved.
CMOD1	76	I/O	TTL	CPU Mode bit 1. Input must be set to logic 0 (grounded); other encodings reserved.
GND	9	-	Power	Ground reference for logic and I/O pins.
GND	15	-	Power	Ground reference for logic and I/O pins.
GND	21	-	Power	Ground reference for logic and I/O pins.
GND	33	-	Power	Ground reference for logic and I/O pins.
GND	39	-	Power	Ground reference for logic and I/O pins.
GND	45	-	Power	Ground reference for logic and I/O pins.
GND	54	-	Power	Ground reference for logic and I/O pins.
GND	57	-	Power	Ground reference for logic and I/O pins.
GND	63	-	Power	Ground reference for logic and I/O pins.
GND	69	-	Power	Ground reference for logic and I/O pins.
GND	82	-	Power	Ground reference for logic and I/O pins.
GND	87	-	Power	Ground reference for logic and I/O pins.
GND	94	-	Power	Ground reference for logic and I/O pins.
GNDA	4	-	Power	The ground reference for the analog circuits (ADC, Analog Comparators, etc.). These are separated from GND to minimize the electrical noise contained on VDD from affecting the analog functions.
GNDA	97	-	Power	The ground reference for the analog circuits (ADC, Analog Comparators, etc.). These are separated from GND to minimize the electrical noise contained on VDD from affecting the analog functions.
$\overline{HIB}$	51	O	TTL	An output that indicates the processor is in hibernate mode.
I2C0SCL	70	I/O	OD	I2C module 0 clock
I2C0SDA	71	I/O	OD	I2C module 0 data
I2C1SCL	34	I/O	OD	I2C module 1 clock
I2C1SDA	35	I/O	OD	I2C module 1 data
LDO	7	-	Power	Low drop-out regulator output voltage. This pin requires an external capacitor between the pin and GND of 1 $\mu$ F or greater. When the on-chip LDO is used to provide power to the logic, the LDO pin must also be connected to the VDD25 pins at the board level in addition to the decoupling capacitor(s).
NC	36	-	-	No connect
NC	37	-	-	No connect
NC	83	-	-	No connect
NC	84	-	-	No connect
NC	85	-	-	No connect

Pin Name	Pin Number	Pin Type	Buffer Type	Description
NC	86	-	-	No connect
OSC0	48	I	Analog	Main oscillator crystal input or an external clock reference input.
OSC1	49	O	Analog	Main oscillator crystal output.
PA0	26	I/O	TTL	GPIO port A bit 0
PA1	27	I/O	TTL	GPIO port A bit 1
PA2	28	I/O	TTL	GPIO port A bit 2
PA3	29	I/O	TTL	GPIO port A bit 3
PA4	30	I/O	TTL	GPIO port A bit 4
PA5	31	I/O	TTL	GPIO port A bit 5
PA6	34	I/O	TTL	GPIO port A bit 6
PA7	35	I/O	TTL	GPIO port A bit 7
PB0	66	I/O	TTL	GPIO port B bit 0
PB1	67	I/O	TTL	GPIO port B bit 1
PB2	70	I/O	TTL	GPIO port B bit 2
PB3	71	I/O	TTL	GPIO port B bit 3
PB4	92	I/O	TTL	GPIO port B bit 4
PB5	91	I/O	TTL	GPIO port B bit 5
PB6	90	I/O	TTL	GPIO port B bit 6
PB7	89	I/O	TTL	GPIO port B bit 7
PC0	80	I/O	TTL	GPIO port C bit 0
PC1	79	I/O	TTL	GPIO port C bit 1
PC2	78	I/O	TTL	GPIO port C bit 2
PC3	77	I/O	TTL	GPIO port C bit 3
PC4	25	I/O	TTL	GPIO port C bit 4
PC5	24	I/O	TTL	GPIO port C bit 5
PC6	23	I/O	TTL	GPIO port C bit 6
PC7	22	I/O	TTL	GPIO port C bit 7
PD0	10	I/O	TTL	GPIO port D bit 0
PD1	11	I/O	TTL	GPIO port D bit 1
PD2	12	I/O	TTL	GPIO port D bit 2
PD3	13	I/O	TTL	GPIO port D bit 3
PE0	72	I/O	TTL	GPIO port E bit 0
PE1	73	I/O	TTL	GPIO port E bit 1
PE2	74	I/O	TTL	GPIO port E bit 2
PE3	75	I/O	TTL	GPIO port E bit 3
PF0	47	I/O	TTL	GPIO port F bit 0
PF1	61	I/O	TTL	GPIO port F bit 1
PF2	60	I/O	TTL	GPIO port F bit 2
PF3	59	I/O	TTL	GPIO port F bit 3
PF4	58	I/O	TTL	GPIO port F bit 4
PF5	46	I/O	TTL	GPIO port F bit 5
PF6	43	I/O	TTL	GPIO port F bit 6

Pin Name	Pin Number	Pin Type	Buffer Type	Description
PF7	42	I/O	TTL	GPIO port F bit 7
PG0	19	I/O	TTL	GPIO port G bit 0
PG1	18	I/O	TTL	GPIO port G bit 1
PG2	17	I/O	TTL	GPIO port G bit 2
PG3	16	I/O	TTL	GPIO port G bit 3
PG4	41	I/O	TTL	GPIO port G bit 4
PG5	40	I/O	TTL	GPIO port G bit 5
RST	64	I	TTL	System reset input.
SSI0Clk	28	I/O	TTL	SSI module 0 clock
SSI0Fss	29	I/O	TTL	SSI module 0 frame
SSI0Rx	30	I	TTL	SSI module 0 receive
SSI0Tx	31	O	TTL	SSI module 0 transmit
SSI1Clk	72	I/O	TTL	SSI module 1 clock
SSI1Fss	73	I/O	TTL	SSI module 1 frame
SSI1Rx	74	I	TTL	SSI module 1 receive
SSI1Tx	75	O	TTL	SSI module 1 transmit
SWCLK	80	I	TTL	JTAG/SWD CLK
SWDIO	79	I/O	TTL	JTAG TMS and SWDIO
SWO	77	O	TTL	JTAG TDO and SWO
TCK	80	I	TTL	JTAG/SWD CLK
TDI	78	I	TTL	JTAG TDI
TDO	77	O	TTL	JTAG TDO and SWO
TMS	79	I/O	TTL	JTAG TMS and SWDIO
TRST	89	I	TTL	JTAG TRSTn
U0Rx	26	I	TTL	UART module 0 receive. When in IrDA mode, this signal has IrDA modulation.
U0Tx	27	O	TTL	UART module 0 transmit. When in IrDA mode, this signal has IrDA modulation.
U1Rx	12	I	TTL	UART module 1 receive. When in IrDA mode, this signal has IrDA modulation.
U1Tx	13	O	TTL	UART module 1 transmit. When in IrDA mode, this signal has IrDA modulation.
U2Rx	19	I	TTL	UART 2 Receive. When in IrDA mode, this signal has IrDA modulation.
U2Tx	18	O	TTL	UART 2 Transmit. When in IrDA mode, this signal has IrDA modulation.
VBAT	55	-	Power	Power source for the Hibernation Module. It is normally connected to the positive terminal of a battery and serves as the battery backup/Hibernation Module power-source supply.
VDD	8	-	Power	Positive supply for I/O and some logic.
VDD	20	-	Power	Positive supply for I/O and some logic.
VDD	32	-	Power	Positive supply for I/O and some logic.
VDD	44	-	Power	Positive supply for I/O and some logic.
VDD	56	-	Power	Positive supply for I/O and some logic.



Pin Name	Pin Number	Pin Type	Buffer Type	Description
VDD	68	-	Power	Positive supply for I/O and some logic.
VDD	81	-	Power	Positive supply for I/O and some logic.
VDD	93	-	Power	Positive supply for I/O and some logic.
VDD25	14	-	Power	Positive supply for most of the logic function, including the processor core and most peripherals.
VDD25	38	-	Power	Positive supply for most of the logic function, including the processor core and most peripherals.
VDD25	62	-	Power	Positive supply for most of the logic function, including the processor core and most peripherals.
VDD25	88	-	Power	Positive supply for most of the logic function, including the processor core and most peripherals.
VDDA	3	-	Power	The positive supply (3.3 V) for the analog circuits (ADC, Analog Comparators, etc.). These are separated from VDD to minimize the electrical noise contained on VDD from affecting the analog functions.
VDDA	98	-	Power	The positive supply (3.3 V) for the analog circuits (ADC, Analog Comparators, etc.). These are separated from VDD to minimize the electrical noise contained on VDD from affecting the analog functions.
$\overline{\text{WAKE}}$	50	I	OD	An external input that brings the processor out of hibernate mode when asserted.
XOSC0	52	I	Analog	Hibernation Module oscillator crystal input or an external clock reference input. Note that this is either a 4.19-MHz crystal or a 32.768-kHz oscillator for the Hibernation Module RTC. See the <b>CLKSEL</b> bit in the <b>HIBCTL</b> register.
XOSC1	53	O	Analog	Hibernation Module oscillator crystal output.

Table 18-3. Signals by Function, Except for GPIO

Function	Pin Name	Pin Number	Pin Type	Buffer Type	Description
ADC	ADC0	1	I	Analog	Analog-to-digital converter input 0.
	ADC1	2	I	Analog	Analog-to-digital converter input 1.
	ADC2	5	I	Analog	Analog-to-digital converter input 2.
	ADC3	6	I	Analog	Analog-to-digital converter input 3.
	ADC4	100	I	Analog	Analog-to-digital converter input 4.
	ADC5	99	I	Analog	Analog-to-digital converter input 5.
	ADC6	96	I	Analog	Analog-to-digital converter input 6.
	ADC7	95	I	Analog	Analog-to-digital converter input 7.

Function	Pin Name	Pin Number	Pin Type	Buffer Type	Description
Analog Comparators	C0+	90	I	Analog	Analog comparator 0 positive input
	C0-	92	I	Analog	Analog comparator 0 negative input
	C0o	58	O	TTL	Analog comparator 0 output
	C1+	24	I	Analog	Analog comparator positive input
	C1-	91	I	Analog	Analog comparator 1 negative input
	C1o	46	O	TTL	Analog comparator 1 output
	C2+	23	I	Analog	Analog comparator positive input
	C2-	22	I	Analog	Analog comparator 2 negative input
	C2o	23	O	TTL	Analog comparator 2 output
General-Purpose Timers	CCP0	66	I/O	TTL	Capture/Compare/PWM 0
	CCP1	43	I/O	TTL	Capture/Compare/PWM 1
	CCP2	67	I/O	TTL	Capture/Compare/PWM 2
	CCP3	41	I/O	TTL	Capture/Compare/PWM 3
	CCP4	42	I/O	TTL	Capture/Compare/PWM 4
	CCP5	25	I/O	TTL	Capture/Compare/PWM 5
I2C	I2C0SCL	70	I/O	OD	I2C module 0 clock
	I2C0SDA	71	I/O	OD	I2C module 0 data
	I2C1SCL	34	I/O	OD	I2C module 1 clock
	I2C1SDA	35	I/O	OD	I2C module 1 data
JTAG/SWD/SWO	SWCLK	80	I	TTL	JTAG/SWD CLK
	SWDIO	79	I/O	TTL	JTAG TMS and SWDIO
	SWO	77	O	TTL	JTAG TDO and SWO
	TCK	80	I	TTL	JTAG/SWD CLK
	TDI	78	I	TTL	JTAG TDI
	TDO	77	O	TTL	JTAG TDO and SWO
	TMS	79	I/O	TTL	JTAG TMS and SWDIO

Function	Pin Name	Pin Number	Pin Type	Buffer Type	Description
Power	GND	9	-	Power	Ground reference for logic and I/O pins.
	GND	15	-	Power	Ground reference for logic and I/O pins.
	GND	21	-	Power	Ground reference for logic and I/O pins.
	GND	33	-	Power	Ground reference for logic and I/O pins.
	GND	39	-	Power	Ground reference for logic and I/O pins.
	GND	45	-	Power	Ground reference for logic and I/O pins.
	GND	54	-	Power	Ground reference for logic and I/O pins.
	GND	57	-	Power	Ground reference for logic and I/O pins.
	GND	63	-	Power	Ground reference for logic and I/O pins.
	GND	69	-	Power	Ground reference for logic and I/O pins.
	GND	82	-	Power	Ground reference for logic and I/O pins.
	GND	87	-	Power	Ground reference for logic and I/O pins.
	GND	94	-	Power	Ground reference for logic and I/O pins.
	GND <sub>A</sub>	4	-	Power	The ground reference for the analog circuits (ADC, Analog Comparators, etc.). These are separated from GND to minimize the electrical noise contained on VDD from affecting the analog functions.
	GND <sub>A</sub>	97	-	Power	The ground reference for the analog circuits (ADC, Analog Comparators, etc.). These are separated from GND to minimize the electrical noise contained on VDD from affecting the analog functions.
	HIB	51	O	TTL	An output that indicates the processor is in hibernate mode.
	LDO	7	-	Power	Low drop-out regulator output voltage. This pin requires an external capacitor between the pin and GND of 1 $\mu$ F or greater. When the on-chip LDO is used to provide power to the logic, the LDO pin must also be connected to the VDD25 pins at the board level in addition to the decoupling capacitor(s).
	VBAT	55	-	Power	Power source for the Hibernation Module. It is normally connected to the positive terminal of a battery and serves as the battery backup/Hibernation Module power-source supply.
	VDD	8	-	Power	Positive supply for I/O and some logic.
	VDD	20	-	Power	Positive supply for I/O and some logic.
	VDD	32	-	Power	Positive supply for I/O and some logic.
	VDD	44	-	Power	Positive supply for I/O and some logic.
	VDD	56	-	Power	Positive supply for I/O and some logic.
	VDD	68	-	Power	Positive supply for I/O and some logic.
	VDD	81	-	Power	Positive supply for I/O and some logic.
	VDD	93	-	Power	Positive supply for I/O and some logic.
VDD25	14	-	Power	Positive supply for most of the logic function, including the processor core and most peripherals.	
VDD25	38	-	Power	Positive supply for most of the logic function, including the processor core and most peripherals.	
VDD25	62	-	Power	Positive supply for most of the logic function, including the processor core and most peripherals.	

Function	Pin Name	Pin Number	Pin Type	Buffer Type	Description
	VDD25	88	-	Power	Positive supply for most of the logic function, including the processor core and most peripherals.
	VDDA	3	-	Power	The positive supply (3.3 V) for the analog circuits (ADC, Analog Comparators, etc.). These are separated from VDD to minimize the electrical noise contained on VDD from affecting the analog functions.
	VDDA	98	-	Power	The positive supply (3.3 V) for the analog circuits (ADC, Analog Comparators, etc.). These are separated from VDD to minimize the electrical noise contained on VDD from affecting the analog functions.
	$\overline{\text{WAKE}}$	50	I	OD	An external input that brings the processor out of hibernate mode when asserted.
SSI	SSI0Clk	28	I/O	TTL	SSI module 0 clock
	SSI0Fss	29	I/O	TTL	SSI module 0 frame
	SSI0Rx	30	I	TTL	SSI module 0 receive
	SSI0Tx	31	O	TTL	SSI module 0 transmit
	SSI1Clk	72	I/O	TTL	SSI module 1 clock
	SSI1Fss	73	I/O	TTL	SSI module 1 frame
	SSI1Rx	74	I	TTL	SSI module 1 receive
	SSI1Tx	75	O	TTL	SSI module 1 transmit
System Control & Clocks	CMOD0	65	I/O	TTL	CPU Mode bit 0. Input must be set to logic 0 (grounded); other encodings reserved.
	CMOD1	76	I/O	TTL	CPU Mode bit 1. Input must be set to logic 0 (grounded); other encodings reserved.
	OSC0	48	I	Analog	Main oscillator crystal input or an external clock reference input.
	OSC1	49	O	Analog	Main oscillator crystal output.
	$\overline{\text{RST}}$	64	I	TTL	System reset input.
	$\overline{\text{TRST}}$	89	I	TTL	JTAG TRSTn
	XOSC0	52	I	Analog	Hibernation Module oscillator crystal input or an external clock reference input. Note that this is either a 4.19-MHz crystal or a 32.768-kHz oscillator for the Hibernation Module RTC. See the <code>CLKSEL</code> bit in the <code>HIBCTL</code> register.
	XOSC1	53	O	Analog	Hibernation Module oscillator crystal output.
UART	U0Rx	26	I	TTL	UART module 0 receive. When in IrDA mode, this signal has IrDA modulation.
	U0Tx	27	O	TTL	UART module 0 transmit. When in IrDA mode, this signal has IrDA modulation.
	U1Rx	12	I	TTL	UART module 1 receive. When in IrDA mode, this signal has IrDA modulation.
	U1Tx	13	O	TTL	UART module 1 transmit. When in IrDA mode, this signal has IrDA modulation.
	U2Rx	19	I	TTL	UART 2 Receive. When in IrDA mode, this signal has IrDA modulation.
	U2Tx	18	O	TTL	UART 2 Transmit. When in IrDA mode, this signal has IrDA modulation.

Table 18-4. GPIO Pins and Alternate Functions

GPIO Pin	Pin Number	Multiplexed Function	Multiplexed Function
PA0	26	U0Rx	
PA1	27	U0Tx	
PA2	28	SSI0Clk	
PA3	29	SSI0Fss	
PA4	30	SSI0Rx	
PA5	31	SSI0Tx	
PA6	34	I2C1SCL	
PA7	35	I2C1SDA	
PB0	66	CCP0	
PB1	67	CCP2	
PB2	70	I2C0SCL	
PB3	71	I2C0SDA	
PB4	92	C0-	
PB5	91	C1-	
PB6	90	C0+	
PB7	89	TRST	
PC0	80	TCK	SWCLK
PC1	79	TMS	SWDIO
PC2	78	TDI	
PC3	77	TDO	SWO
PC4	25	CCP5	
PC5	24	C1+	
PC6	23	C2+	C2o
PC7	22	C2-	
PD0	10		
PD1	11		
PD2	12	U1Rx	
PD3	13	U1Tx	
PE0	72	SSI1Clk	
PE1	73	SSI1Fss	
PE2	74	SSI1Rx	
PE3	75	SSI1Tx	
PF0	47		
PF1	61		
PF2	60		
PF3	59		
PF4	58	C0o	
PF5	46	C1o	
PF6	43	CCP1	
PF7	42	CCP4	
PG0	19	U2Rx	

GPIO Pin	Pin Number	Multiplexed Function	Multiplexed Function
PG1	18	U2Tx	
PG2	17		
PG3	16		
PG4	41	CCP3	
PG5	40		

## 19 Operating Characteristics

**Table 19-1. Temperature Characteristics**

Characteristic	Symbol	Value	Unit
Operating temperature range <sup>a</sup>	$T_A$	-40 to +85	°C

a. Maximum storage temperature is 150°C.

**Table 19-2. Thermal Characteristics**

Characteristic	Symbol	Value	Unit
Thermal resistance (junction to ambient) <sup>a</sup>	$\Theta_{JA}$	55.3	°C/W
Average junction temperature <sup>b</sup>	$T_J$	$T_A + (P_{AVG} \cdot \Theta_{JA})$	°C

a. Junction to ambient thermal resistance  $\Theta_{JA}$  numbers are determined by a package simulator.

b. Power dissipation is a function of temperature.

## 20 Electrical Characteristics

### 20.1 DC Characteristics

#### 20.1.1 Maximum Ratings

The maximum ratings are the limits to which the device can be subjected without permanently damaging the device.

**Note:** The device is not guaranteed to operate properly at the maximum ratings.

**Table 20-1. Maximum Ratings**

Characteristic <sup>a</sup>	Symbol	Value		Unit
		Min	Max	
I/O supply voltage ( $V_{DD}$ )	$V_{DD}$	0	4	V
Core supply voltage ( $V_{DD25}$ )	$V_{DD25}$	0	4	V
Analog supply voltage ( $V_{DDA}$ )	$V_{DDA}$	0	4	V
Battery supply voltage ( $V_{BAT}$ )	$V_{BAT}$	0	4	V
Input voltage	$V_{IN}$	-0.3	5.5	V
Maximum current per output pins	I	-	25	mA

a. Voltages are measured with respect to GND.

**Important:** This device contains circuitry to protect the inputs against damage due to high-static voltages or electric fields; however, it is advised that normal precautions be taken to avoid application of any voltage higher than maximum-rated voltages to this high-impedance circuit. Reliability of operation is enhanced if unused inputs are connected to an appropriate logic voltage level (for example, either GND or  $V_{DD}$ ).

#### 20.1.2 Recommended DC Operating Conditions

**Table 20-2. Recommended DC Operating Conditions**

Parameter	Parameter Name	Min	Nom	Max	Unit	
$V_{DD}$	I/O supply voltage	3.0	3.3	3.6	V	
$V_{DD25}$	Core supply voltage	2.25	2.5	2.75	V	
$V_{DDA}$	Analog supply voltage	3.0	3.3	3.6	V	
$V_{BAT}$	Battery supply voltage	2.3	3.0	3.6	V	
$V_{IH}$	High-level input voltage	2.0	-	5.0	V	
$V_{IL}$	Low-level input voltage	-0.3	-	1.3	V	
$V_{SIH}$	High-level input voltage for Schmitt trigger inputs	$0.8 * V_{DD}$	-	$V_{DD}$	V	
$V_{SIL}$	Low-level input voltage for Schmitt trigger inputs	0	-	$0.2 * V_{DD}$	V	
$V_{OH}$	High-level output voltage	2.4	-	-	V	
$V_{OL}$	Low-level output voltage	-	-	0.4	V	
$I_{OH}$	High-level source current, $V_{OH}=2.4$ V					
		2-mA Drive	2.0	-	-	mA
		4-mA Drive	4.0	-	-	mA
		8-mA Drive	8.0	-	-	mA



Parameter	Parameter Name	Min	Nom	Max	Unit
I <sub>OL</sub>	Low-level sink current, V <sub>OL</sub> =0.4 V				
	2-mA Drive	2.0	-	-	mA
	4-mA Drive	4.0	-	-	mA
	8-mA Drive	8.0	-	-	mA

### 20.1.3 On-Chip Low Drop-Out (LDO) Regulator Characteristics

Table 20-3. LDO Regulator Characteristics

Parameter	Parameter Name	Min	Nom	Max	Unit
V <sub>LDOOUT</sub>	Programmable internal (logic) power supply output value	2.25	2.5	2.75	V
	Output voltage accuracy	-	2%	-	%
t <sub>PON</sub>	Power-on time	-	-	100	μs
t <sub>ON</sub>	Time on	-	-	200	μs
t <sub>OFF</sub>	Time off	-	-	100	μs
V <sub>STEP</sub>	Step programming incremental voltage	-	50	-	mV
C <sub>LDO</sub>	External filter capacitor size for internal power supply	1.0	-	3.0	μF

### 20.1.4 Power Specifications

The power measurements specified in the tables that follow are run on the core processor using SRAM with the following specifications (except as noted):

- V<sub>DD</sub> = 3.3 V
- V<sub>DD25</sub> = 2.50 V
- V<sub>BAT</sub> = 3.0 V
- V<sub>DDA</sub> = 3.3 V
- Temperature = 25°C
- Clock Source (MOSC) = 3.579545 MHz Crystal Oscillator
- Main oscillator (MOSC) = enabled
- Internal oscillator (IOSC) = disabled

### 20.1.5 Flash Memory Characteristics

Table 20-4. Flash Memory Characteristics

Parameter	Parameter Name	Min	Nom	Max	Unit
PE <sub>CYC</sub>	Number of guaranteed program/erase cycles before failure <sup>a</sup>	10,000	100,000	-	cycles
T <sub>RET</sub>	Data retention at average operating temperature of 85°C	10	-	-	years
T <sub>PROG</sub>	Word program time	20	-	-	μs
T <sub>ERASE</sub>	Page erase time	20	-	-	ms
T <sub>ME</sub>	Mass erase time	200	-	-	ms

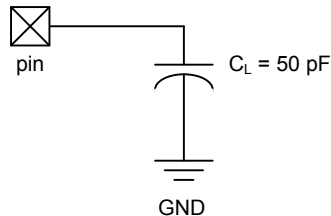
a. A program/erase cycle is defined as switching the bits from 1-> 0 -> 1.

## 20.2 AC Characteristics

### 20.2.1 Load Conditions

Unless otherwise specified, the following conditions are true for all timing measurements. Timing measurements are for 4-mA drive strength.

Figure 20-1. Load Conditions



### 20.2.2 Clocks

Table 20-5. Phase Locked Loop (PLL) Characteristics

Parameter	Parameter Name	Min	Nom	Max	Unit
$f_{\text{ref\_crystal}}$	Crystal reference <sup>a</sup>	3.579545	-	8.192	MHz
$f_{\text{ref\_ext}}$	External clock reference <sup>a</sup>	3.579545	-	8.192	MHz
$f_{\text{pll}}$	PLL frequency <sup>b</sup>	-	400	-	MHz
$T_{\text{READY}}$	PLL lock time	-	-	0.5	ms

a. The exact value is determined by the crystal value programmed into the XTAL field of the Run-Mode Clock Configuration (RCC) register.

b. PLL frequency is automatically calculated by the hardware based on the XTAL field of the RCC register.

Table 20-6. Clock Characteristics

Parameter	Parameter Name	Min	Nom	Max	Unit
$f_{\text{IOSC}}$	Internal 12 MHz oscillator frequency	8.4	12	15.6	MHz
$f_{\text{IOSC30KHZ}}$	Internal 30 KHz oscillator frequency	21	30	39	KHz
$f_{\text{XOSC}}$	Hibernation module oscillator frequency	-	4.194304	-	MHz
$f_{\text{XOSC\_XTAL}}$	Crystal reference for hibernation oscillator	-	4.194304	-	MHz
$f_{\text{XOSC\_EXT}}$	External clock reference for hibernation module	-	32.768	-	KHz
$f_{\text{MOSC}}$	Main oscillator frequency	1	-	8	MHz
$t_{\text{MOSC\_per}}$	Main oscillator period	125	-	1000	ns
$f_{\text{ref\_crystal\_bypass}}$	Crystal reference using the main oscillator (PLL in BYPASS mode) <sup>a</sup>	1	-	8	MHz
$f_{\text{ref\_ext\_bypass}}$	External clock reference (PLL in BYPASS mode) <sup>a</sup>	0	-	50	MHz
$f_{\text{system\_clock}}$	System clock	0	-	50	MHz

a. The ADC must be clocked from the PLL or directly from a 14-MHz to 18-MHz clock source to operate properly.

Table 20-7. Crystal Characteristics

Parameter Name	Value				Units
Frequency	8	6	4	3.5	MHz

Parameter Name	Value				Units
	±50	±50	±50	±50	
Frequency tolerance	±50	±50	±50	±50	ppm
Aging	±5	±5	±5	±5	ppm/yr
Oscillation mode	Parallel	Parallel	Parallel	Parallel	
Temperature stability (0 - 85 °C)	±25	±25	±25	±25	ppm
Motional capacitance (typ)	27.8	37.0	55.6	63.5	pF
Motional inductance (typ)	14.3	19.1	28.6	32.7	mH
Equivalent series resistance (max)	120	160	200	220	Ω
Shunt capacitance (max)	10	10	10	10	pF
Load capacitance (typ)	16	16	16	16	pF
Drive level (typ)	100	100	100	100	μW

### 20.2.3 Analog-to-Digital Converter

Table 20-8. ADC Characteristics

Parameter	Parameter Name	Min	Nom	Max	Unit
V <sub>ADCIN</sub>	Maximum single-ended, full-scale analog input voltage	-	-	3.0	V
	Minimum single-ended, full-scale analog input voltage	-	-	0	V
	Maximum differential, full-scale analog input voltage	-	-	1.5	V
	Minimum differential, full-scale analog input voltage	-	-	-1.5	V
C <sub>ADCIN</sub>	Equivalent input capacitance	-	1	-	pF
N	Resolution	-	10	-	bits
f <sub>ADC</sub>	ADC internal clock frequency	14	16	18	MHz
t <sub>ADCCONV</sub>	Conversion time	-	-	16	t <sub>ADC</sub> cycles <sup>a</sup>
f <sub>ADCCONV</sub>	Conversion rate	875	1000	1125	k samples/s
INL	Integral nonlinearity	-	-	±1	LSB
DNL	Differential nonlinearity	-	-	±1	LSB
OFF	Offset	-	-	±1	LSB
GAIN	Gain	-	-	±1	LSB

a.  $t_{ADC} = 1/f_{ADC \text{ clock}}$

### 20.2.4 Analog Comparator

Table 20-9. Analog Comparator Characteristics

Parameter	Parameter Name	Min	Nom	Max	Unit
V <sub>OS</sub>	Input offset voltage	-	±10	±25	mV
V <sub>CM</sub>	Input common mode voltage range	0	-	V <sub>DD</sub> -1.5	V
C <sub>MRR</sub>	Common mode rejection ratio	50	-	-	dB
T <sub>RT</sub>	Response time	-	-	1	μs
T <sub>MC</sub>	Comparator mode change to Output Valid	-	-	10	μs

Table 20-10. Analog Comparator Voltage Reference Characteristics

Parameter	Parameter Name	Min	Nom	Max	Unit
R <sub>HR</sub>	Resolution high range	-	V <sub>DD</sub> /32	-	LSB

Parameter	Parameter Name	Min	Nom	Max	Unit
R <sub>LR</sub>	Resolution low range	-	V <sub>DD</sub> /24	-	LSB
A <sub>HR</sub>	Absolute accuracy high range	-	-	±1/2	LSB
A <sub>LR</sub>	Absolute accuracy low range	-	-	±1/4	LSB

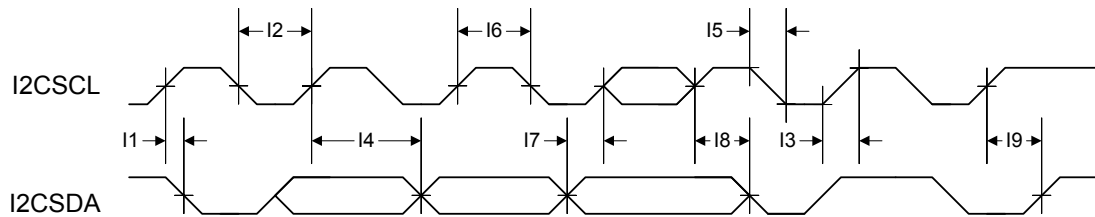
## 20.2.5 I<sup>2</sup>C

Table 20-11. I<sup>2</sup>C Characteristics

Parameter No.	Parameter	Parameter Name	Min	Nom	Max	Unit
I1 <sup>a</sup>	t <sub>SCH</sub>	Start condition hold time	36	-	-	system clocks
I2 <sup>a</sup>	t <sub>LP</sub>	Clock Low period	36	-	-	system clocks
I3 <sup>b</sup>	t <sub>SRT</sub>	I <sup>2</sup> C <sub>SCL</sub> /I <sup>2</sup> C <sub>SDA</sub> rise time (V <sub>IL</sub> =0.5 V to V <sub>IH</sub> =2.4 V)	-	-	(see note b)	ns
I4 <sup>a</sup>	t <sub>DH</sub>	Data hold time	2	-	-	system clocks
I5 <sup>c</sup>	t <sub>SFT</sub>	I <sup>2</sup> C <sub>SCL</sub> /I <sup>2</sup> C <sub>SDA</sub> fall time (V <sub>IH</sub> =2.4 V to V <sub>IL</sub> =0.5 V)	-	9	10	ns
I6 <sup>a</sup>	t <sub>HT</sub>	Clock High time	24	-	-	system clocks
I7 <sup>a</sup>	t <sub>DS</sub>	Data setup time	18	-	-	system clocks
I8 <sup>a</sup>	t <sub>SCSR</sub>	Start condition setup time (for repeated start condition only)	36	-	-	system clocks
I9 <sup>a</sup>	t <sub>SCS</sub>	Stop condition setup time	24	-	-	system clocks

- a. Values depend on the value programmed into the TPR bit in the I<sup>2</sup>C Master Timer Period (I2CMTPR) register; a TPR programmed for the maximum I<sup>2</sup>C<sub>SCL</sub> frequency (TPR=0x2) results in a minimum output timing as shown in the table above. The I<sup>2</sup>C interface is designed to scale the actual data transition time to move it to the middle of the I<sup>2</sup>C<sub>SCL</sub> Low period. The actual position is affected by the value programmed into the TPR; however, the numbers given in the above values are minimum values.
- b. Because I<sup>2</sup>C<sub>SCL</sub> and I<sup>2</sup>C<sub>SDA</sub> are open-drain-type outputs, which the controller can only actively drive Low, the time I<sup>2</sup>C<sub>SCL</sub> or I<sup>2</sup>C<sub>SDA</sub> takes to reach a high level depends on external signal capacitance and pull-up resistor values.
- c. Specified at a nominal 50 pF load.

Figure 20-2. I<sup>2</sup>C Timing



## 20.2.6 Hibernation Module

The Hibernation Module requires special system implementation considerations since it is intended to power-down all other sections of its host device. The system power-supply distribution and interfaces of the system must be driven to 0 V<sub>DC</sub> or powered down with the same regulator controlled by  $\overline{\text{HIB}}$ .

The regulators controlled by  $\overline{\text{HIB}}$  are expected to have a settling time of 250 μs or less.

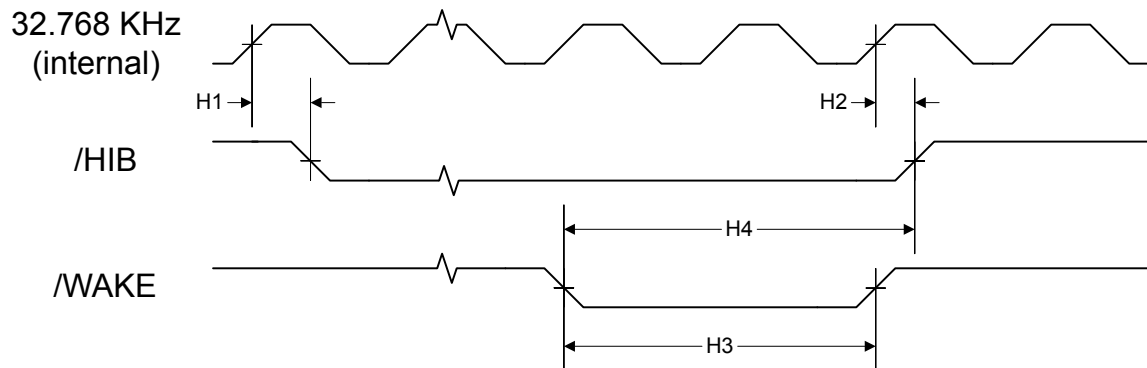
Table 20-12. Hibernation Module Characteristics

Parameter No	Parameter	Parameter Name	Min	Nom	Max	Unit
H1	t <sub>HIB_LOW</sub>	Internal 32.768 KHz clock reference rising edge to /HIB asserted	-	200	-	μs

Parameter No	Parameter	Parameter Name	Min	Nom	Max	Unit
H2	$t_{\text{HIB\_HIGH}}$	Internal 32.768 KHz clock reference rising edge to /HIB deasserted	-	30	-	$\mu\text{s}$
H3	$t_{\text{WAKE\_ASSERT}}$	/WAKE assertion time	62	-	-	$\mu\text{s}$
H4	$t_{\text{WAKETOHIB}}$	/WAKE assert to /HIB desassert	62	-	124	$\mu\text{s}$
H5	$t_{\text{XOSC\_SETTLE}}$	XOSC settling time <sup>a</sup>	20	-	-	ms
H6	$t_{\text{HIB\_REG\_WRITE}}$	Time for a write to non-volatile registers in HIB module to complete	92	-	-	$\mu\text{s}$
H7	$t_{\text{HIB\_TO\_VDD}}$	$\overline{\text{HIB}}$ deassert to VDD and VDD25 at minimum operational level	-	-	250	$\mu\text{s}$

a. This parameter is highly sensitive to PCB layout and trace lengths, which may make this parameter time longer. Care must be taken in PCB design to minimize trace lengths and RLC (resistance, inductance, capacitance).

**Figure 20-3. Hibernation Module Timing**



## 20.2.7 Synchronous Serial Interface (SSI)

**Table 20-13. SSI Characteristics**

Parameter No.	Parameter	Parameter Name	Min	Nom	Max	Unit
S1	$t_{\text{clk\_per}}$	SSIClk cycle time	2	-	65024	system clocks
S2	$t_{\text{clk\_high}}$	SSIClk high time	-	1/2	-	t clk_per
S3	$t_{\text{clk\_low}}$	SSIClk low time	-	1/2	-	t clk_per
S4	$t_{\text{clkrf}}$	SSIClk rise/fall time	-	7.4	26	ns
S5	$t_{\text{DMd}}$	Data from master valid delay time	0	-	20	ns
S6	$t_{\text{DMs}}$	Data from master setup time	20	-	-	ns
S7	$t_{\text{DMh}}$	Data from master hold time	40	-	-	ns
S8	$t_{\text{DSs}}$	Data from slave setup time	20	-	-	ns
S9	$t_{\text{DSh}}$	Data from slave hold time	40	-	-	ns

Figure 20-4. SSI Timing for TI Frame Format (FRF=01), Single Transfer Timing Measurement

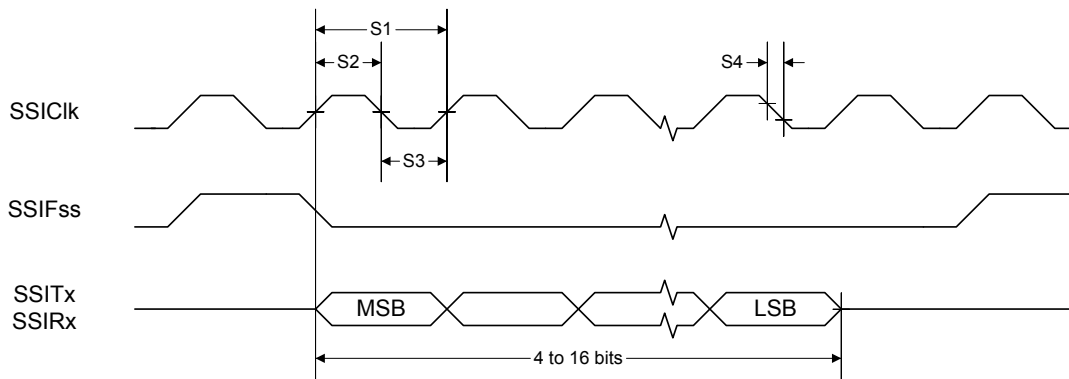


Figure 20-5. SSI Timing for MICROWIRE Frame Format (FRF=10), Single Transfer

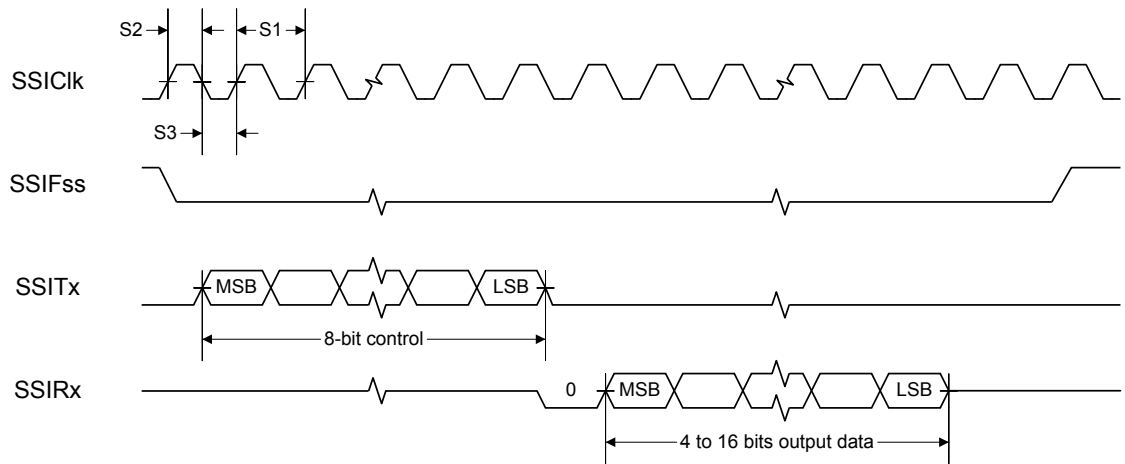
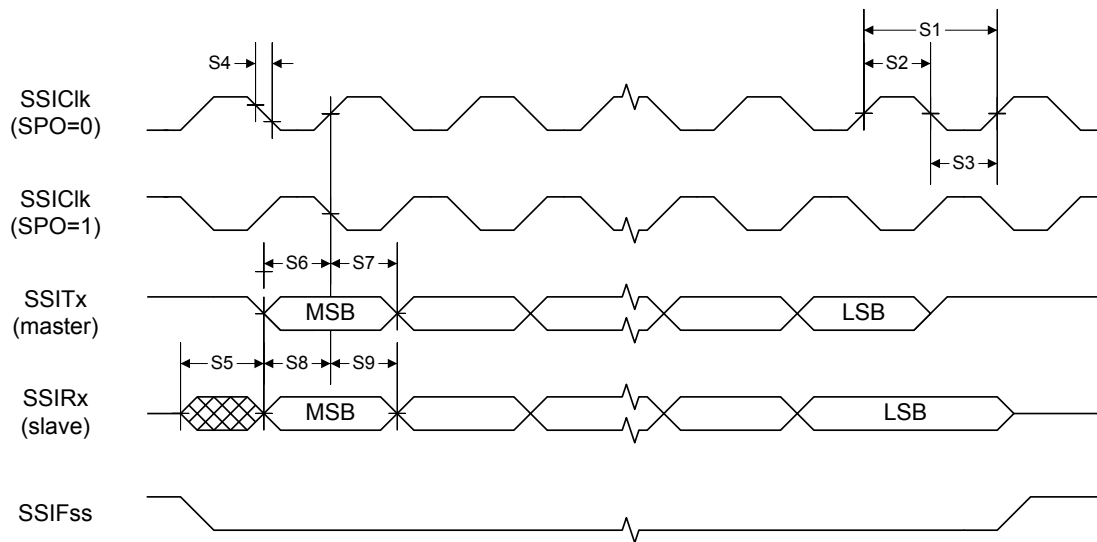


Figure 20-6. SSI Timing for SPI Frame Format (FRF=00), with SPH=1



## 20.2.8 JTAG and Boundary Scan

Table 20-14. JTAG Characteristics

Parameter No.	Parameter	Parameter Name	Min	Nom	Max	Unit
J1	$f_{TCK}$	TCK operational clock frequency	0	-	10	MHz
J2	$t_{TCK}$	TCK operational clock period	100	-	-	ns
J3	$t_{TCK\_LOW}$	TCK clock Low time	-	$t_{TCK}$	-	ns
J4	$t_{TCK\_HIGH}$	TCK clock High time	-	$t_{TCK}$	-	ns
J5	$t_{TCK\_R}$	TCK rise time	0	-	10	ns
J6	$t_{TCK\_F}$	TCK fall time	0	-	10	ns
J7	$t_{TMS\_SU}$	TMS setup time to TCK rise	20	-	-	ns
J8	$t_{TMS\_HLD}$	TMS hold time from TCK rise	20	-	-	ns
J9	$t_{TDI\_SU}$	TDI setup time to TCK rise	25	-	-	ns
J10	$t_{TDI\_HLD}$	TDI hold time from TCK rise	25	-	-	ns
J11	$t_{TDO\_ZDV}$	TCK fall to Data Valid from High-Z	-	23	35	ns
		2-mA drive		15	26	ns
		4-mA drive		14	25	ns
		8-mA drive with slew rate control		18	29	ns
J12	$t_{TDO\_DV}$	TCK fall to Data Valid from Data Valid	-	21	35	ns
		2-mA drive		14	25	ns
		4-mA drive		13	24	ns
		8-mA drive with slew rate control		18	28	ns

Parameter No.	Parameter	Parameter Name	Min	Nom	Max	Unit
J13	TCK fall to High-Z from Data Valid	2-mA drive	-	9	11	ns
		4-mA drive		7	9	ns
		8-mA drive		6	8	ns
		8-mA drive with slew rate control		7	9	ns
J14	$t_{TRST}$	$\overline{TRST}$ assertion time	100	-	-	ns
J15	$t_{TRST\_SU}$	$\overline{TRST}$ setup time to TCK rise	10	-	-	ns

Figure 20-7. JTAG Test Clock Input Timing

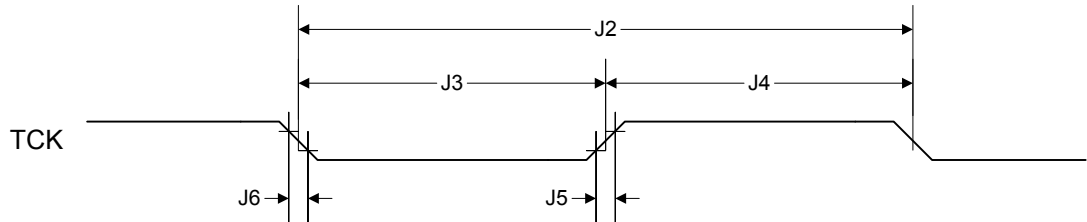


Figure 20-8. JTAG Test Access Port (TAP) Timing

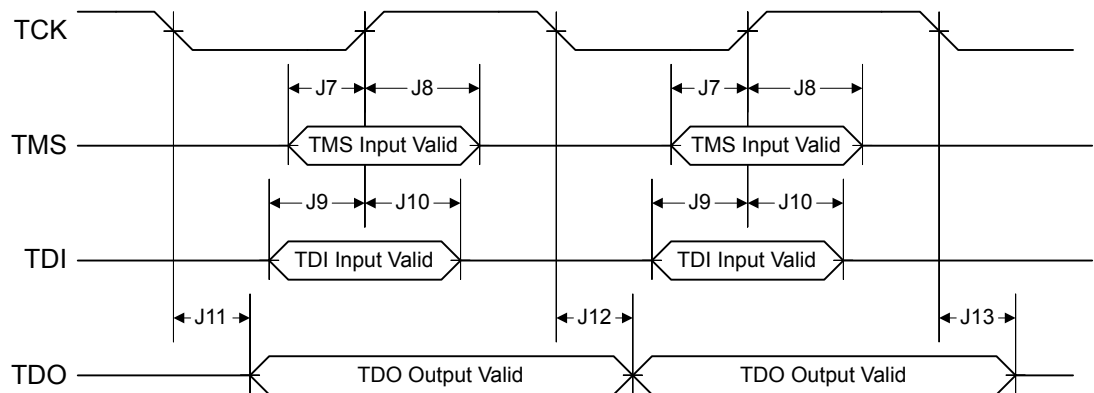
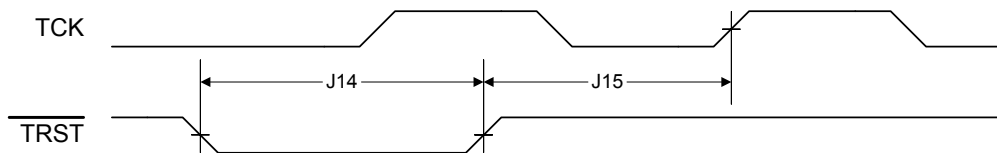


Figure 20-9. JTAG TRST Timing



### 20.2.9 General-Purpose I/O

**Note:** All GPIOs are 5 V-tolerant.



Table 20-15. GPIO Characteristics

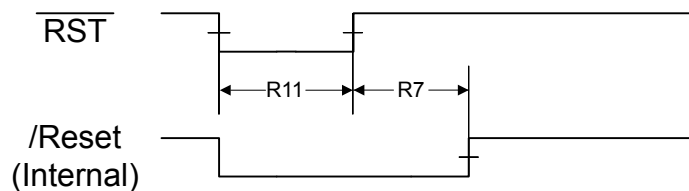
Parameter	Parameter Name	Condition	Min	Nom	Max	Unit
$t_{\text{GPIO R}}$	GPIO Rise Time (from 20% to 80% of $V_{\text{DD}}$ )	2-mA drive	-	17	26	ns
		4-mA drive		9	13	ns
		8-mA drive		6	9	ns
		8-mA drive with slew rate control		10	12	ns
$t_{\text{GPIO F}}$	GPIO Fall Time (from 80% to 20% of $V_{\text{DD}}$ )	2-mA drive	-	17	25	ns
		4-mA drive		8	12	ns
		8-mA drive		6	10	ns
		8-mA drive with slew rate control		11	13	ns

## 20.2.10 Reset

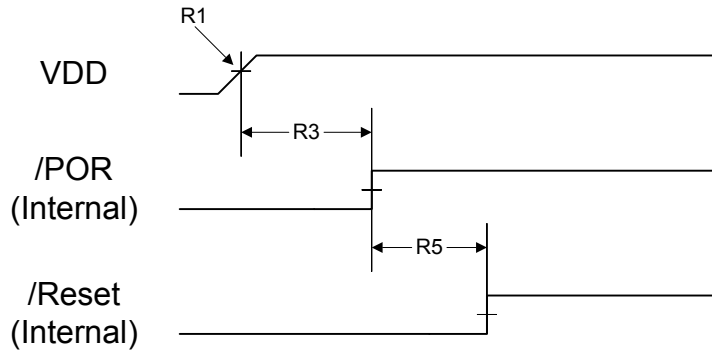
Table 20-16. Reset Characteristics

Parameter No.	Parameter	Parameter Name	Min	Nom	Max	Unit
R1	$V_{\text{TH}}$	Reset threshold	-	2.0	-	V
R2	$V_{\text{BTH}}$	Brown-Out threshold	2.85	2.9	2.95	V
R3	$T_{\text{POR}}$	Power-On Reset timeout	-	10	-	ms
R4	$T_{\text{BOR}}$	Brown-Out timeout	-	500	-	$\mu\text{s}$
R5	$T_{\text{IRPOR}}$	Internal reset timeout after POR	6	-	11	ms
R6	$T_{\text{IRBOR}}$	Internal reset timeout after BOR <sup>a</sup>	0	-	1	$\mu\text{s}$
R7	$T_{\text{IRHWR}}$	Internal reset timeout after hardware reset ( $\overline{\text{RST}}$ pin)	0	-	1	ms
R8	$T_{\text{IRSWR}}$	Internal reset timeout after software-initiated system reset <sup>a</sup>	2.5	-	20	$\mu\text{s}$
R9	$T_{\text{IRWDR}}$	Internal reset timeout after watchdog reset <sup>a</sup>	2.5	-	20	$\mu\text{s}$
R10	$T_{\text{VDDRISE}}$	Supply voltage ( $V_{\text{DD}}$ ) rise time (0V-3.3V)	-	-	100	ms
R11	$T_{\text{MIN}}$	Minimum $\overline{\text{RST}}$ pulse width	2	-	-	$\mu\text{s}$

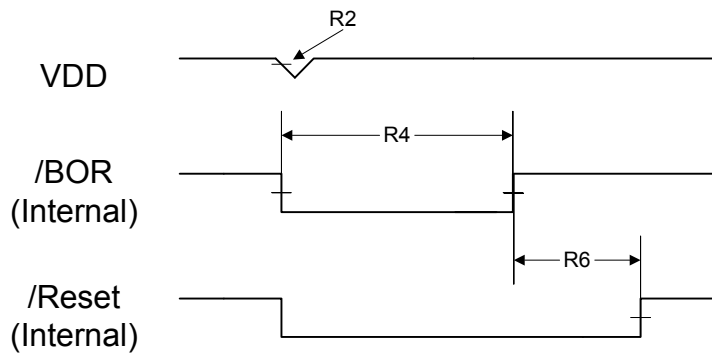
a.  $20 * t_{\text{MOSC\_per}}$

Figure 20-10. External Reset Timing ( $\overline{\text{RST}}$ )

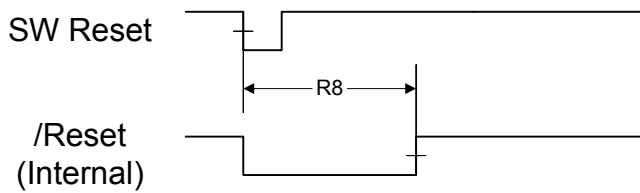
**Figure 20-11. Power-On Reset Timing**



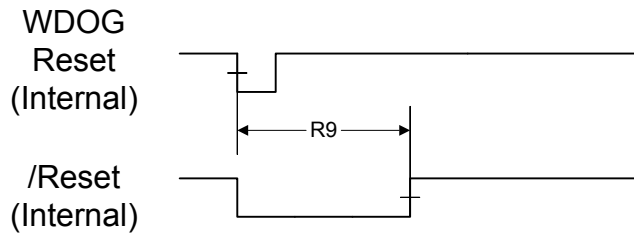
**Figure 20-12. Brown-Out Reset Timing**



**Figure 20-13. Software Reset Timing**

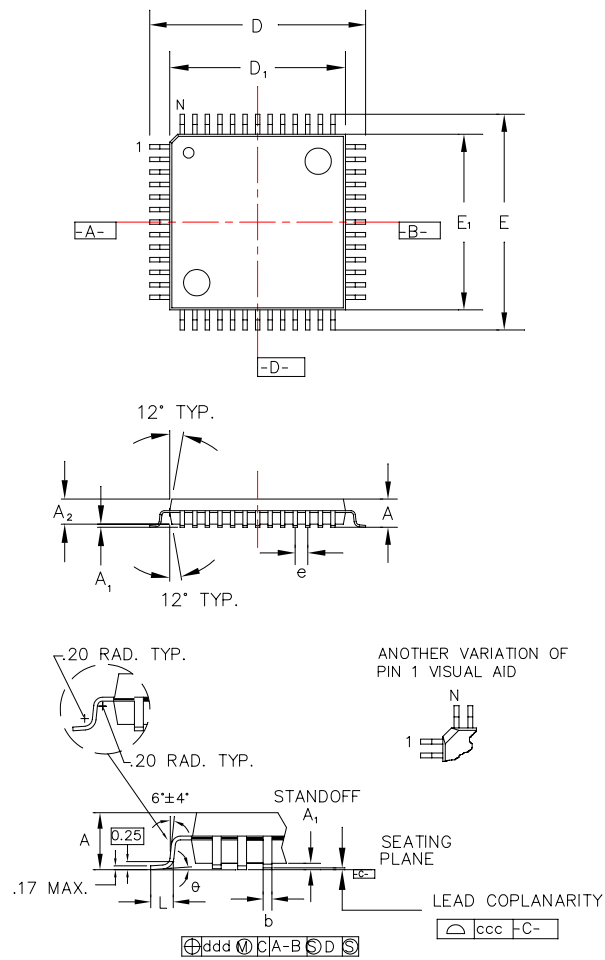


**Figure 20-14. Watchdog Reset Timing**



## 21 Package Information

Figure 21-1. 100-Pin LQFP Package



**Note:** The following notes apply to the package drawing.

1. All dimensions shown in mm.
2. Dimensions shown are nominal with tolerances indicated.
3. Foot length 'L' is measured at gage plane 0.25 mm above seating plane.

Body +2.00 mm Footprint, 1.4 mm package thickness		
Symbols	Leads	100L
A	Max.	1.60
A <sub>1</sub>		0.05 Min./0.15 Max.
A <sub>2</sub>	±0.05	1.40
D	±0.20	16.00
D <sub>1</sub>	±0.05	14.00
E	±0.20	16.00
E <sub>1</sub>	±0.05	14.00
L	±0.15/-0.10	0.60
e	BASIC	0.50
b	±0.05	0.22
θ	===	0°~7°
ddd	Max.	0.08
ccc	Max.	0.08
JEDEC Reference Drawing		MS-026
Variation Designator		BED

## A Serial Flash Loader

### A.1 Serial Flash Loader

The Stellaris<sup>®</sup> serial flash loader is a preprogrammed flash-resident utility used to download code to the flash memory of a device without the use of a debug interface. The serial flash loader uses a simple packet interface to provide synchronous communication with the device. The flash loader runs off the crystal and does not enable the PLL, so its speed is determined by the crystal used. The two serial interfaces that can be used are the UART0 and SSI0 interfaces. For simplicity, both the data format and communication protocol are identical for both serial interfaces.

### A.2 Interfaces

Once communication with the flash loader is established via one of the serial interfaces, that interface is used until the flash loader is reset or new code takes over. For example, once you start communicating using the SSI port, communications with the flash loader via the UART are disabled until the device is reset.

#### A.2.1 UART

The Universal Asynchronous Receivers/Transmitters (UART) communication uses a fixed serial format of 8 bits of data, no parity, and 1 stop bit. The baud rate used for communication is automatically detected by the flash loader and can be any valid baud rate supported by the host and the device. The auto detection sequence requires that the baud rate should be no more than 1/32 the crystal frequency of the board that is running the serial flash loader. This is actually the same as the hardware limitation for the maximum baud rate for any UART on a Stellaris<sup>®</sup> device which is calculated as follows:

$$\text{Max Baud Rate} = \text{System Clock Frequency} / 16$$

In order to determine the baud rate, the serial flash loader needs to determine the relationship between its own crystal frequency and the baud rate. This is enough information for the flash loader to configure its UART to the same baud rate as the host. This automatic baud-rate detection allows the host to use any valid baud rate that it wants to communicate with the device.

The method used to perform this automatic synchronization relies on the host sending the flash loader two bytes that are both 0x55. This generates a series of pulses to the flash loader that it can use to calculate the ratios needed to program the UART to match the host's baud rate. After the host sends the pattern, it attempts to read back one byte of data from the UART. The flash loader returns the value of 0xCC to indicate successful detection of the baud rate. If this byte is not received after at least twice the time required to transfer the two bytes, the host can resend another pattern of 0x55, 0x55, and wait for the 0xCC byte again until the flash loader acknowledges that it has received a synchronization pattern correctly. For example, the time to wait for data back from the flash loader should be calculated as at least  $2 * (20(\text{bits}/\text{sync}) / \text{baud rate} (\text{bits}/\text{sec}))$ . For a baud rate of 115200, this time is  $2 * (20 / 115200)$  or 0.35 ms.

#### A.2.2 SSI

The Synchronous Serial Interface (SSI) port also uses a fixed serial format for communications, with the framing defined as Motorola format with SPH set to 1 and SPO set to 1. See "Frame Formats" on page 333 in the SSI chapter for more information on formats for this transfer protocol. Like the UART, this interface has hardware requirements that limit the maximum speed that the SSI clock can run. This allows the SSI clock to be at most 1/12 the crystal frequency of the board running

the flash loader. Since the host device is the master, the SSI on the flash loader device does not need to determine the clock as it is provided directly by the host.

## A.3 Packet Handling

All communications, with the exception of the UART auto-baud, are done via defined packets that are acknowledged (ACK) or not acknowledged (NAK) by the devices. The packets use the same format for receiving and sending packets, including the method used to acknowledge successful or unsuccessful reception of a packet.

### A.3.1 Packet Format

All packets sent and received from the device use the following byte-packed format.

```
struct
{
    unsigned char ucSize;
    unsigned char ucChecksum;
    unsigned char Data[];
};
```

ucSize	The first byte received holds the total size of the transfer including the size and checksum bytes.
ucChecksum	This holds a simple checksum of the bytes in the data buffer only. The algorithm is $Data[0]+Data[1]+\dots+Data[ucSize-3]$ .
Data	This is the raw data intended for the device, which is formatted in some form of command interface. There should be $ucSize-2$ bytes of data provided in this buffer to or from the device.

### A.3.2 Sending Packets

The actual bytes of the packet can be sent individually or all at once; the only limitation is that commands that cause flash memory access should limit the download sizes to prevent losing bytes during flash programming. This limitation is discussed further in the section that describes the serial flash loader command, `COMMAND_SEND_DATA` (see “`COMMAND_SEND_DATA (0x24)`” on page 448).

Once the packet has been formatted correctly by the host, it should be sent out over the UART or SSI interface. Then the host should poll the UART or SSI interface for the first non-zero data returned from the device. The first non-zero byte will either be an ACK (0xCC) or a NAK (0x33) byte from the device indicating the packet was received successfully (ACK) or unsuccessfully (NAK). This does not indicate that the actual contents of the command issued in the data portion of the packet were valid, just that the packet was received correctly.

### A.3.3 Receiving Packets

The flash loader sends a packet of data in the same format that it receives a packet. The flash loader may transfer leading zero data before the first actual byte of data is sent out. The first non-zero byte is the size of the packet followed by a checksum byte, and finally followed by the data itself. There is no break in the data after the first non-zero byte is sent from the flash loader. Once the device communicating with the flash loader receives all the bytes, it must either ACK or NAK the packet to indicate that the transmission was successful. The appropriate response after sending a NAK to the flash loader is to resend the command that failed and request the data again. If needed, the host may send leading zeros before sending down the ACK/NAK signal to the flash loader, as the

flash loader only accepts the first non-zero data as a valid response. This zero padding is needed by the SSI interface in order to receive data to or from the flash loader.

## A.4 Commands

The next section defines the list of commands that can be sent to the flash loader. The first byte of the data should always be one of the defined commands, followed by data or parameters as determined by the command that is sent.

### A.4.1 COMMAND\_PING (0x20)

This command simply accepts the command and sets the global status to success. The format of the packet is as follows:

```
Byte[0] = 0x03;
Byte[1] = checksum(Byte[2]);
Byte[2] = COMMAND_PING;
```

The ping command has 3 bytes and the value for `COMMAND_PING` is 0x20 and the checksum of one byte is that same byte, making `Byte[1]` also 0x20. Since the ping command has no real return status, the receipt of an ACK can be interpreted as a successful ping to the flash loader.

### A.4.2 COMMAND\_GET\_STATUS (0x23)

This command returns the status of the last command that was issued. Typically, this command should be sent after every command to ensure that the previous command was successful or to properly respond to a failure. The command requires one byte in the data of the packet and should be followed by reading a packet with one byte of data that contains a status code. The last step is to ACK or NAK the received data so the flash loader knows that the data has been read.

```
Byte[0] = 0x03
Byte[1] = checksum(Byte[2])
Byte[2] = COMMAND_GET_STATUS
```

### A.4.3 COMMAND\_DOWNLOAD (0x21)

This command is sent to the flash loader to indicate where to store data and how many bytes will be sent by the `COMMAND_SEND_DATA` commands that follow. The command consists of two 32-bit values that are both transferred MSB first. The first 32-bit value is the address to start programming data into, while the second is the 32-bit size of the data that will be sent. This command also triggers an erase of the full area to be programmed so this command takes longer than other commands. This results in a longer time to receive the ACK/NAK back from the board. This command should be followed by a `COMMAND_GET_STATUS` to ensure that the Program Address and Program size are valid for the device running the flash loader.

The format of the packet to send this command is as follows:

```
Byte[0] = 11
Byte[1] = checksum(Bytes[2:10])
Byte[2] = COMMAND_DOWNLOAD
Byte[3] = Program Address [31:24]
Byte[4] = Program Address [23:16]
Byte[5] = Program Address [15:8]
Byte[6] = Program Address [7:0]
Byte[7] = Program Size [31:24]
```

```
Byte[8] = Program Size [23:16]
Byte[9] = Program Size [15:8]
Byte[10] = Program Size [7:0]
```

#### A.4.4 **COMMAND\_SEND\_DATA (0x24)**

This command should only follow a `COMMAND_DOWNLOAD` command or another `COMMAND_SEND_DATA` command if more data is needed. Consecutive send data commands automatically increment address and continue programming from the previous location. The caller should limit transfers of data to a maximum 8 bytes of packet data to allow the flash to program successfully and not overflow input buffers of the serial interfaces. The command terminates programming once the number of bytes indicated by the `COMMAND_DOWNLOAD` command has been received. Each time this function is called it should be followed by a `COMMAND_GET_STATUS` to ensure that the data was successfully programmed into the flash. If the flash loader sends a NAK to this command, the flash loader does not increment the current address to allow retransmission of the previous data.

```
Byte[0] = 11
Byte[1] = checksum(Bytes[2:10])
Byte[2] = COMMAND_SEND_DATA
Byte[3] = Data[0]
Byte[4] = Data[1]
Byte[5] = Data[2]
Byte[6] = Data[3]
Byte[7] = Data[4]
Byte[8] = Data[5]
Byte[9] = Data[6]
Byte[10] = Data[7]
```

#### A.4.5 **COMMAND\_RUN (0x22)**

This command is used to tell the flash loader to execute from the address passed as the parameter in this command. This command consists of a single 32-bit value that is interpreted as the address to execute. The 32-bit value is transmitted MSB first and the flash loader responds with an ACK signal back to the host device before actually executing the code at the given address. This allows the host to know that the command was received successfully and the code is now running.

```
Byte[0] = 7
Byte[1] = checksum(Bytes[2:6])
Byte[2] = COMMAND_RUN
Byte[3] = Execute Address[31:24]
Byte[4] = Execute Address[23:16]
Byte[5] = Execute Address[15:8]
Byte[6] = Execute Address[7:0]
```

#### A.4.6 **COMMAND\_RESET (0x25)**

This command is used to tell the flash loader device to reset. This is useful when downloading a new image that overwrote the flash loader and wants to start from a full reset. Unlike the `COMMAND_RUN` command, this allows the initial stack pointer to be read by the hardware and set up for the new code. It can also be used to reset the flash loader if a critical error occurs and the host device wants to restart communication with the flash loader.



```
Byte[0] = 3  
Byte[1] = checksum(Byte[2])  
Byte[2] = COMMAND_RESET
```

The flash loader responds with an ACK signal back to the host device before actually executing the software reset to the device running the flash loader. This allows the host to know that the command was received successfully and the part will be reset.

## B Register Quick Reference

31	30	29	28	27	26	25	24	23	22	21	20	19	18	17	16														
15	14	13	12	11	10	9	8	7	6	5	4	3	2	1	0														
<b>System Control</b>																													
Base 0x400F.E000																													
<b>DID0, type RO, offset 0x000, reset -</b>																													
VER								CLASS																					
				MAJOR								MINOR																	
<b>PBORCTL, type R/W, offset 0x030, reset 0x0000.7FFD</b>																													
														BORIOR															
<b>LDOPTL, type R/W, offset 0x034, reset 0x0000.0000</b>																													
														VADJ															
<b>RIS, type RO, offset 0x050, reset 0x0000.0000</b>																													
								PLLRIS						BORRIS															
<b>IMC, type R/W, offset 0x054, reset 0x0000.0000</b>																													
								PLLLIM						BORIM															
<b>MISC, type R/W1C, offset 0x058, reset 0x0000.0000</b>																													
								PLLLMIS						BORMIS															
<b>RESC, type R/W, offset 0x05C, reset -</b>																													
								LDO		SW		WDT		BOR		POR		EXT											
<b>RCC, type R/W, offset 0x060, reset 0x07A0.3AD1</b>																													
PWRDN				ACG		SYSDIV				USESYS																			
				BYPASS		XTAL				OSCSRC				IOSCDIS		MOSCDIS													
<b>PLLCFG, type RO, offset 0x064, reset -</b>																													
OD				F								R																	
<b>RCC2, type R/W, offset 0x070, reset 0x0780.2800</b>																													
USERCC2				SYSDIV2																									
PWRDN2				BYPASS2						OSCSRC2																			
<b>DSLPLKCFG, type R/W, offset 0x144, reset 0x0780.0000</b>																													
DSDIVORIDE																													
								DSOSCSRC																					
<b>DID1, type RO, offset 0x004, reset -</b>																													
VER				FAM				PARTNO																					
PINCOUNT								TEMP		PKG		ROHS		QUAL															
<b>DC0, type RO, offset 0x008, reset 0x003F.001F</b>																													
SRAMSZ																													
FLASHSZ																													
<b>DC1, type RO, offset 0x010, reset 0x0001.33FF</b>																													
MINSYS				MAXADCS				MPU		HIB		TEMPSNS		PLL		WDT		SWO		SWD		ADC							
																						JTAG							
<b>DC2, type RO, offset 0x014, reset 0x070F.5037</b>																													
I2C1		I2C0		COMP2		COMP1		COMP0						TIMER3		TIMER2		TIMER1		TIMER0									
												SSI1		SSI0		UART2		UART1		UART0									
<b>DC3, type RO, offset 0x018, reset 0x3FFF.7FC0</b>																													
		CCP5		CCP4		CCP3		CCP2		CCP1		CCP0		ADC7		ADC6		ADC5		ADC4		ADC3		ADC2		ADC1		ADC0	
C20		C2PLUS		C2MINUS		C10		C1PLUS		C1MINUS		C00		C0PLUS		C0MINUS													

31	30	29	28	27	26	25	24	23	22	21	20	19	18	17	16	
15	14	13	12	11	10	9	8	7	6	5	4	3	2	1	0	
<b>DC4, type RO, offset 0x01C, reset 0x0000.00FF</b>																
								GPIOH	GPIOG	GPIOF	GPIOE	GPIOD	GPIOC	GPIOB	GPIOA	
<b>RCGC0, type R/W, offset 0x100, reset 0x00000040</b>																
								MAXADCSPD			HIB	WDT	ADC			
<b>SCGC0, type R/W, offset 0x110, reset 0x00000040</b>																
								MAXADCSPD			HIB	WDT	ADC			
<b>DCGC0, type R/W, offset 0x120, reset 0x00000040</b>																
								MAXADCSPD			HIB	WDT	ADC			
<b>RCGC1, type R/W, offset 0x104, reset 0x00000000</b>																
				COMP2			COMP1	COMP0					TIMER3	TIMER2	TIMER1	TIMER0
I2C1		I2C0								SSI1	SSI0	UART2		UART1	UART0	
<b>SCGC1, type R/W, offset 0x114, reset 0x00000000</b>																
				COMP2			COMP1	COMP0					TIMER3	TIMER2	TIMER1	TIMER0
I2C1		I2C0								SSI1	SSI0	UART2		UART1	UART0	
<b>DCGC1, type R/W, offset 0x124, reset 0x00000000</b>																
				COMP2			COMP1	COMP0					TIMER3	TIMER2	TIMER1	TIMER0
I2C1		I2C0								SSI1	SSI0	UART2		UART1	UART0	
<b>RCGC2, type R/W, offset 0x108, reset 0x00000000</b>																
								GPIOH	GPIOG	GPIOF	GPIOE	GPIOD	GPIOC	GPIOB	GPIOA	
<b>SCGC2, type R/W, offset 0x118, reset 0x00000000</b>																
								GPIOH	GPIOG	GPIOF	GPIOE	GPIOD	GPIOC	GPIOB	GPIOA	
<b>DCGC2, type R/W, offset 0x128, reset 0x00000000</b>																
								GPIOH	GPIOG	GPIOF	GPIOE	GPIOD	GPIOC	GPIOB	GPIOA	
<b>SRCR0, type R/W, offset 0x040, reset 0x00000000</b>																
								HIB			WDT	ADC				
<b>SRCR1, type R/W, offset 0x044, reset 0x00000000</b>																
				COMP2			COMP1	COMP0					TIMER3	TIMER2	TIMER1	TIMER0
I2C1		I2C0								SSI1	SSI0	UART2		UART1	UART0	
<b>SRCR2, type R/W, offset 0x048, reset 0x00000000</b>																
								GPIOH	GPIOG	GPIOF	GPIOE	GPIOD	GPIOC	GPIOB	GPIOA	
<b>Hibernation Module</b>																
Base 0x400F.C000																
<b>HIBRTCC, type RO, offset 0x000, reset 0x0000.0000</b>																
RTCC																
RTCC																
<b>HIBRTCM0, type R/W, offset 0x004, reset 0xFFFF.FFFF</b>																
RTCM0																
RTCM0																
<b>HIBRTCM1, type R/W, offset 0x008, reset 0xFFFF.FFFF</b>																
RTCM1																
RTCM1																
<b>HIBRTCLD, type R/W, offset 0x00C, reset 0xFFFF.FFFF</b>																
RTCLD																
RTCLD																

31	30	29	28	27	26	25	24	23	22	21	20	19	18	17	16
15	14	13	12	11	10	9	8	7	6	5	4	3	2	1	0
<b>HIBCTL, type R/W, offset 0x010, reset 0x0000.0000</b>															
								VABORT	CLK32EN	LOWBATEN	PINWEN	RTCWEN	CLKSEL	HIBREQ	RTCEN
<b>HIBIM, type R/W, offset 0x014, reset 0x0000.0000</b>															
												EXTW	LOWBAT	RTCALT1	RTCALT0
<b>HIBRIS, type RO, offset 0x018, reset 0x0000.0000</b>															
												EXTW	LOWBAT	RTCALT1	RTCALT0
<b>HIBMIS, type RO, offset 0x01C, reset 0x0000.0000</b>															
												EXTW	LOWBAT	RTCALT1	RTCALT0
<b>HIBIC, type R/W1C, offset 0x020, reset 0x0000.0000</b>															
												EXTW	LOWBAT	RTCALT1	RTCALT0
<b>HIBRTCT, type R/W, offset 0x024, reset 0x0000.7FFF</b>															
TRIM															
<b>HIBDATA, type R/W, offset 0x030-0x12C, reset 0x0000.0000</b>															
RTD															
RTD															
<b>Internal Memory</b>															
<b>Flash Control Offset</b>															
Base 0x400F.D000															
<b>FMA, type R/W, offset 0x000, reset 0x0000.0000</b>															
OFFSET															
<b>FMD, type R/W, offset 0x004, reset 0x0000.0000</b>															
DATA															
DATA															
<b>FMC, type R/W, offset 0x008, reset 0x0000.0000</b>															
WRKEY															
												COMT	MERASE	ERASE	WRITE
<b>FCRIS, type RO, offset 0x00C, reset 0x0000.0000</b>															
														PRIS	ARIS
<b>FCIM, type R/W, offset 0x010, reset 0x0000.0000</b>															
														PMASK	AMASK
<b>FCMISC, type R/W1C, offset 0x014, reset 0x0000.0000</b>															
														PMISC	AMISC
<b>Internal Memory</b>															
<b>System Control Offset</b>															
Base 0x400F.E000															
<b>USEACL, type R/W, offset 0x140, reset 0x31</b>															
USEC															
<b>FMPRE0, type R/W, offset 0x130 and 0x200, reset 0xFFFF.FFFF</b>															
READ_ENABLE															
READ_ENABLE															

31	30	29	28	27	26	25	24	23	22	21	20	19	18	17	16
15	14	13	12	11	10	9	8	7	6	5	4	3	2	1	0
<b>FMPPE0, type R/W, offset 0x134 and 0x400, reset 0xFFFF.FFFF</b>															
PROG_ENABLE															
PROG_ENABLE															
<b>USER_DBG, type R/W, offset 0x1D0, reset 0xFFFF.FFFE</b>															
NW				DATA								DATA			
DATA												DBG1		DBG0	
<b>USER_REG0, type R/W, offset 0x1E0, reset 0xFFFF.FFFF</b>															
NW				DATA								DATA			
DATA															
<b>USER_REG1, type R/W, offset 0x1E4, reset 0xFFFF.FFFF</b>															
NW				DATA								DATA			
DATA															
<b>FMPRE1, type R/W, offset 0x204, reset 0x0000.0000</b>															
READ_ENABLE															
READ_ENABLE															
<b>FMPRE2, type R/W, offset 0x208, reset 0x0000.0000</b>															
READ_ENABLE															
READ_ENABLE															
<b>FMPRE3, type R/W, offset 0x20C, reset 0x0000.0000</b>															
READ_ENABLE															
READ_ENABLE															
<b>FMPPE1, type R/W, offset 0x404, reset 0x0000.0000</b>															
PROG_ENABLE															
PROG_ENABLE															
<b>FMPPE2, type R/W, offset 0x408, reset 0x0000.0000</b>															
PROG_ENABLE															
PROG_ENABLE															
<b>FMPPE3, type R/W, offset 0x40C, reset 0x0000.0000</b>															
PROG_ENABLE															
PROG_ENABLE															
<b>General-Purpose Input/Outputs (GPIOs)</b>															
GPIO Port A base: 0x4000.4000															
GPIO Port B base: 0x4000.5000															
GPIO Port C base: 0x4000.6000															
GPIO Port D base: 0x4000.7000															
GPIO Port E base: 0x4002.4000															
GPIO Port F base: 0x4002.5000															
GPIO Port G base: 0x4002.6000															
GPIO Port H base: 0x4002.7000															
<b>GPIODATA, type R/W, offset 0x000, reset 0x0000.0000</b>															
												DATA			
<b>GPIODIR, type R/W, offset 0x400, reset 0x0000.0000</b>															
												DIR			
<b>GPIOIS, type R/W, offset 0x404, reset 0x0000.0000</b>															
												IS			
<b>GPIOIBE, type R/W, offset 0x408, reset 0x0000.0000</b>															
												IBE			
<b>GPIOIEV, type R/W, offset 0x40C, reset 0x0000.0000</b>															
												IEV			

31	30	29	28	27	26	25	24	23	22	21	20	19	18	17	16
15	14	13	12	11	10	9	8	7	6	5	4	3	2	1	0
GPIOIM, type R/W, offset 0x410, reset 0x0000.0000															
												IME			
GPIORIS, type RO, offset 0x414, reset 0x0000.0000															
												RIS			
GPIOMIS, type RO, offset 0x418, reset 0x0000.0000															
												MIS			
GPIOICR, type W1C, offset 0x41C, reset 0x0000.0000															
												IC			
GPIOAFSEL, type R/W, offset 0x420, reset -															
												AFSEL			
GPIODR2R, type R/W, offset 0x500, reset 0x0000.00FF															
												DRV2			
GPIODR4R, type R/W, offset 0x504, reset 0x0000.0000															
												DRV4			
GPIODR8R, type R/W, offset 0x508, reset 0x0000.0000															
												DRV8			
GPIODR, type R/W, offset 0x50C, reset 0x0000.0000															
												ODE			
GPIOPUR, type R/W, offset 0x510, reset -															
												PUE			
GPIOPDR, type R/W, offset 0x514, reset 0x0000.0000															
												PDE			
GPIOSLR, type R/W, offset 0x518, reset 0x0000.0000															
												SRL			
GPIODEN, type R/W, offset 0x51C, reset -															
												DEN			
GPIOLOCK, type R/W, offset 0x520, reset 0x0000.0001															
												LOCK			
												LOCK			
GPIOCR, type -, offset 0x524, reset -															
												CR			
GPIOPeriphID4, type RO, offset 0xFD0, reset 0x0000.0000															
												PID4			
GPIOPeriphID5, type RO, offset 0xFD4, reset 0x0000.0000															
												PID5			

31	30	29	28	27	26	25	24	23	22	21	20	19	18	17	16
15	14	13	12	11	10	9	8	7	6	5	4	3	2	1	0
<b>GPIOPeriphID6, type RO, offset 0xFD8, reset 0x0000.0000</b>															
												PID6			
<b>GPIOPeriphID7, type RO, offset 0xFDC, reset 0x0000.0000</b>															
												PID7			
<b>GPIOPeriphID0, type RO, offset 0xFE0, reset 0x0000.0061</b>															
												PID0			
<b>GPIOPeriphID1, type RO, offset 0xFE4, reset 0x0000.0000</b>															
												PID1			
<b>GPIOPeriphID2, type RO, offset 0xFE8, reset 0x0000.0018</b>															
												PID2			
<b>GPIOPeriphID3, type RO, offset 0xFEC, reset 0x0000.0001</b>															
												PID3			
<b>GPIOCellID0, type RO, offset 0xFF0, reset 0x0000.000D</b>															
												CID0			
<b>GPIOCellID1, type RO, offset 0xFF4, reset 0x0000.00F0</b>															
												CID1			
<b>GPIOCellID2, type RO, offset 0xFF8, reset 0x0000.0005</b>															
												CID2			
<b>GPIOCellID3, type RO, offset 0xFFC, reset 0x0000.00B1</b>															
												CID3			
<b>General-Purpose Timers</b>															
Timer0 base: 0x4003.0000															
Timer1 base: 0x4003.1000															
Timer2 base: 0x4003.2000															
Timer3 base: 0x4003.3000															
<b>GPTMCFG, type R/W, offset 0x000, reset 0x0000.0000</b>															
												GPTMCFG			
<b>GPTMTAMR, type R/W, offset 0x004, reset 0x0000.0000</b>															
												TAAMS	TACMR	TAMR	
<b>GPTMTBMR, type R/W, offset 0x008, reset 0x0000.0000</b>															
												TBAMS	TBCMR	TBMR	
<b>GPTMCTL, type R/W, offset 0x00C, reset 0x0000.0000</b>															
TBPWML		TBOTE	TBEVENT		TBSTALL	TBEN	TAPWML		TAOTE	RTCEN	TAEVENT		TASTALL	TAEN	
<b>GPTMIMR, type R/W, offset 0x018, reset 0x0000.0000</b>															
						CBEIM	CBMIM	TBTOIM				RTCIM	CAEIM	CAMIM	TATOIM
<b>GPTMRIS, type RO, offset 0x01C, reset 0x0000.0000</b>															
						CBERIS	CBMRIS	TBTORIS				RTCRIIS	CAERIS	CAMRIS	TATORIS

31	30	29	28	27	26	25	24	23	22	21	20	19	18	17	16
15	14	13	12	11	10	9	8	7	6	5	4	3	2	1	0
<b>GPTMMIS, type RO, offset 0x020, reset 0x0000.0000</b>															
				CBEMIS CBMMIS TBTOMIS								RTCMIS CAEMIS CAMMIS TATOMIS			
<b>GPTMICR, type W1C, offset 0x024, reset 0x0000.0000</b>															
				CBECINT CBMCINT TBTOCINT								RTCCINT CAECINT CAMCINT TATOCINT			
<b>GPTMTAILR, type R/W, offset 0x028, reset 0x0000.FFFF (16-bit mode) and 0xFFFF.FFFF (32-bit mode)</b>															
TAILRH															
TAILRL															
<b>GPTMTBILR, type R/W, offset 0x02C, reset 0x0000.FFFF</b>															
TBILRL															
<b>GPTMTAMATCHR, type R/W, offset 0x030, reset 0x0000.FFFF (16-bit mode) and 0xFFFF.FFFF (32-bit mode)</b>															
TAMRH															
TAMRL															
<b>GPTMTBMATCHR, type R/W, offset 0x034, reset 0x0000.FFFF</b>															
TBMRL															
<b>GPTMTAPR, type R/W, offset 0x038, reset 0x0000.0000</b>															
TAPSR															
<b>GPTMTBPR, type R/W, offset 0x03C, reset 0x0000.0000</b>															
TBPSR															
<b>GPTMTAPMR, type R/W, offset 0x040, reset 0x0000.0000</b>															
TAPSMR															
<b>GPTMTBPMR, type R/W, offset 0x044, reset 0x0000.0000</b>															
TBPSMR															
<b>GPTMTAR, type RO, offset 0x048, reset 0x0000.FFFF (16-bit mode) and 0xFFFF.FFFF (32-bit mode)</b>															
TARH															
TARL															
<b>GPTMTBR, type RO, offset 0x04C, reset 0x0000.FFFF</b>															
TBRL															
<b>Watchdog Timer</b>															
Base 0x4000.0000															
<b>WDTLOAD, type R/W, offset 0x000, reset 0xFFFF.FFFF</b>															
WDTLoad															
WDTLoad															
<b>WDTVALUE, type RO, offset 0x004, reset 0xFFFF.FFFF</b>															
WDTValue															
WDTValue															
<b>WDTCTL, type R/W, offset 0x008, reset 0x0000.0000</b>															
														RESEN	INTEN
<b>WDTICR, type WO, offset 0x00C, reset -</b>															
WDTIntClr															
WDTIntClr															
<b>WDTRIS, type RO, offset 0x010, reset 0x0000.0000</b>															
WDTRIS															



31	30	29	28	27	26	25	24	23	22	21	20	19	18	17	16
15	14	13	12	11	10	9	8	7	6	5	4	3	2	1	0
<b>WDTMIS, type RO, offset 0x014, reset 0x0000.0000</b>															
WDTMIS															
<b>WDTTST, type R/W, offset 0x418, reset 0x0000.0000</b>															
STALL															
<b>WDTLOCK, type R/W, offset 0xC00, reset 0x0000.0000</b>															
WDTLock															
WDTLock															
<b>WDTPeriphID4, type RO, offset 0xFD0, reset 0x0000.0000</b>															
PID4															
<b>WDTPeriphID5, type RO, offset 0xFD4, reset 0x0000.0000</b>															
PID5															
<b>WDTPeriphID6, type RO, offset 0xFD8, reset 0x0000.0000</b>															
PID6															
<b>WDTPeriphID7, type RO, offset 0xFDC, reset 0x0000.0000</b>															
PID7															
<b>WDTPeriphID0, type RO, offset 0xFE0, reset 0x0000.0005</b>															
PID0															
<b>WDTPeriphID1, type RO, offset 0xFE4, reset 0x0000.0018</b>															
PID1															
<b>WDTPeriphID2, type RO, offset 0xFE8, reset 0x0000.0018</b>															
PID2															
<b>WDTPeriphID3, type RO, offset 0xFEC, reset 0x0000.0001</b>															
PID3															
<b>WDTPCellID0, type RO, offset 0xFF0, reset 0x0000.000D</b>															
CID0															
<b>WDTPCellID1, type RO, offset 0xFF4, reset 0x0000.00F0</b>															
CID1															
<b>WDTPCellID2, type RO, offset 0xFF8, reset 0x0000.0005</b>															
CID2															
<b>WDTPCellID3, type RO, offset 0xFFC, reset 0x0000.00B1</b>															
CID3															
<b>Analog-to-Digital Converter (ADC)</b>															
Base 0x4003.8000															
<b>ADCACTSS, type R/W, offset 0x000, reset 0x0000.0000</b>															
ASEN3 ASEN2 ASEN1 ASEN0															
<b>ADCRIS, type RO, offset 0x004, reset 0x0000.0000</b>															
INR3 INR2 INR1 INR0															

31	30	29	28	27	26	25	24	23	22	21	20	19	18	17	16				
15	14	13	12	11	10	9	8	7	6	5	4	3	2	1	0				
<b>ADCIM, type R/W, offset 0x008, reset 0x0000.0000</b>																			
												MASK3		MASK2		MASK1		MASK0	
<b>ADCISC, type R/W1C, offset 0x00C, reset 0x0000.0000</b>																			
												IN3		IN2		IN1		IN0	
<b>ADCOSTAT, type R/W1C, offset 0x010, reset 0x0000.0000</b>																			
												OV3		OV2		OV1		OV0	
<b>ADCEMUX, type R/W, offset 0x014, reset 0x0000.0000</b>																			
EM3				EM2				EM1				EM0							
<b>ADCUSTAT, type R/W1C, offset 0x018, reset 0x0000.0000</b>																			
												UV3		UV2		UV1		UV0	
<b>ADCSSPRI, type R/W, offset 0x020, reset 0x0000.3210</b>																			
SS3				SS2				SS1				SS0							
<b>ADCPSSI, type WO, offset 0x028, reset -</b>																			
												SS3		SS2		SS1		SS0	
<b>ADCSAC, type R/W, offset 0x030, reset 0x0000.0000</b>																			
												AVG							
<b>ADCSSMUX0, type R/W, offset 0x040, reset 0x0000.0000</b>																			
MUX7				MUX6				MUX5				MUX4							
MUX3				MUX2				MUX1				MUX0							
<b>ADCSSCTL0, type R/W, offset 0x044, reset 0x0000.0000</b>																			
TS7	IE7	END7	D7	TS6	IE6	END6	D6	TS5	IE5	END5	D5	TS4	IE4	END4	D4				
TS3	IE3	END3	D3	TS2	IE2	END2	D2	TS1	IE1	END1	D1	TS0	IE0	END0	D0				
<b>ADCSSFIFO0, type RO, offset 0x048, reset 0x0000.0000</b>																			
												DATA							
<b>ADCSSFIFO1, type RO, offset 0x068, reset 0x0000.0000</b>																			
												DATA							
<b>ADCSSFIFO2, type RO, offset 0x088, reset 0x0000.0000</b>																			
												DATA							
<b>ADCSSFIFO3, type RO, offset 0x0A8, reset 0x0000.0000</b>																			
												DATA							
<b>ADCSSFSTAT0, type RO, offset 0x04C, reset 0x0000.0100</b>																			
FULL				EMPTY				HPTR				TPTR							
<b>ADCSSFSTAT1, type RO, offset 0x06C, reset 0x0000.0100</b>																			
FULL				EMPTY				HPTR				TPTR							
<b>ADCSSFSTAT2, type RO, offset 0x08C, reset 0x0000.0100</b>																			
FULL				EMPTY				HPTR				TPTR							

31	30	29	28	27	26	25	24	23	22	21	20	19	18	17	16		
15	14	13	12	11	10	9	8	7	6	5	4	3	2	1	0		
<b>ADCSSFSTAT3, type RO, offset 0x0AC, reset 0x0000.0100</b>																	
FULL				EMPTY				HPTR				TPTR					
<b>ADCSSMUX1, type RO, offset 0x060, reset 0x0000.0000</b>																	
MUX3				MUX2				MUX1				MUX0					
<b>ADCSSMUX2, type RO, offset 0x080, reset 0x0000.0000</b>																	
MUX3				MUX2				MUX1				MUX0					
<b>ADCSSCTL1, type RO, offset 0x064, reset 0x0000.0000</b>																	
TS3	IE3	END3	D3	TS2	IE2	END2	D2	TS1	IE1	END1	D1	TS0	IE0	END0	D0		
<b>ADCSSCTL2, type RO, offset 0x084, reset 0x0000.0000</b>																	
TS3	IE3	END3	D3	TS2	IE2	END2	D2	TS1	IE1	END1	D1	TS0	IE0	END0	D0		
<b>ADCSSMUX3, type R/W, offset 0x0A0, reset 0x0000.0000</b>																	
												MUX0					
<b>ADCSSCTL3, type R/W, offset 0x0A4, reset 0x0000.0002</b>																	
												TS0	IE0	END0	D0		
<b>ADCTMLB, type RO, offset 0x100, reset 0x0000.0000</b>																	
								CNT		CONT		DIFF		TS		MUX	
<b>ADCTMLB, type WO, offset 0x100, reset 0x0000.0000</b>																	
															LB		
<b>Universal Asynchronous Receivers/Transmitters (UARTs)</b>																	
UART0 base: 0x4000.C000																	
UART1 base: 0x4000.D000																	
UART2 base: 0x4000.E000																	
<b>UARTDR, type R/W, offset 0x000, reset 0x0000.0000</b>																	
				OE	BE	PE	FE	DATA									
<b>UARTSR/UARTECR, type RO, offset 0x004, reset 0x0000.0000</b>																	
												OE	BE	PE	FE		
<b>UARTSR/UARTECR, type WO, offset 0x004, reset 0x0000.0000</b>																	
												DATA					
<b>UARTFR, type RO, offset 0x018, reset 0x0000.0090</b>																	
								TXFE	RXFF	TXFF	RXFE	BUSY					
<b>UARTILPR, type R/W, offset 0x020, reset 0x0000.0000</b>																	
												ILPDVSR					
<b>UARTIBRD, type R/W, offset 0x024, reset 0x0000.0000</b>																	
								DIVINT									
<b>UARTFBRD, type R/W, offset 0x028, reset 0x0000.0000</b>																	
												DIVFRAC					

**Register Quick Reference**

31	30	29	28	27	26	25	24	23	22	21	20	19	18	17	16
15	14	13	12	11	10	9	8	7	6	5	4	3	2	1	0
<b>UARTLCRH, type R/W, offset 0x02C, reset 0x0000.0000</b>															
								SPS	WLEN	FEN		STP2	EPS	PEN	BRK
<b>UARTCTL, type R/W, offset 0x030, reset 0x0000.0300</b>															
						RXE	TXE	LBE					SIRLP	SIREN	UARTEN
<b>UARTFLS, type R/W, offset 0x034, reset 0x0000.0012</b>															
											RXIFLSEL			TXIFLSEL	
<b>UARTIM, type R/W, offset 0x038, reset 0x0000.0000</b>															
					OEIM	BEIM	PEIM	FEIM	RTIM	TXIM	RXIM				
<b>UARTRIS, type RO, offset 0x03C, reset 0x0000.000F</b>															
					OERIS	BERIS	PERIS	FERIS	RTRIS	TXRIS	RXRIS				
<b>UARTMIS, type RO, offset 0x040, reset 0x0000.0000</b>															
					OEMIS	BEMIS	PEMIS	FEMIS	RTMIS	TXMIS	RXMIS				
<b>UARTICR, type W1C, offset 0x044, reset 0x0000.0000</b>															
					OEIC	BEIC	PEIC	FEIC	RTIC	TXIC	RXIC				
<b>UARTPeriphID4, type RO, offset 0xFD0, reset 0x0000.0000</b>															
															PID4
<b>UARTPeriphID5, type RO, offset 0xFD4, reset 0x0000.0000</b>															
															PID5
<b>UARTPeriphID6, type RO, offset 0xFD8, reset 0x0000.0000</b>															
															PID6
<b>UARTPeriphID7, type RO, offset 0xFDC, reset 0x0000.0000</b>															
															PID7
<b>UARTPeriphID0, type RO, offset 0xFE0, reset 0x0000.0011</b>															
															PID0
<b>UARTPeriphID1, type RO, offset 0xFE4, reset 0x0000.0000</b>															
															PID1
<b>UARTPeriphID2, type RO, offset 0xFE8, reset 0x0000.0018</b>															
															PID2
<b>UARTPeriphID3, type RO, offset 0xFEC, reset 0x0000.0001</b>															
															PID3
<b>UARTPCellID0, type RO, offset 0xFF0, reset 0x0000.000D</b>															
															CID0
<b>UARTPCellID1, type RO, offset 0xFF4, reset 0x0000.00F0</b>															
															CID1



31	30	29	28	27	26	25	24	23	22	21	20	19	18	17	16
15	14	13	12	11	10	9	8	7	6	5	4	3	2	1	0
<b>SSIPeriphID1, type RO, offset 0xFE4, reset 0x0000.0000</b>															
												PID1			
<b>SSIPeriphID2, type RO, offset 0xFE8, reset 0x0000.0018</b>															
												PID2			
<b>SSIPeriphID3, type RO, offset 0xFEC, reset 0x0000.0001</b>															
												PID3			
<b>SSIPCellID0, type RO, offset 0xFF0, reset 0x0000.000D</b>															
												CID0			
<b>SSIPCellID1, type RO, offset 0xFF4, reset 0x0000.00F0</b>															
												CID1			
<b>SSIPCellID2, type RO, offset 0xFF8, reset 0x0000.0005</b>															
												CID2			
<b>SSIPCellID3, type RO, offset 0xFFC, reset 0x0000.00B1</b>															
												CID3			
<b>Inter-Integrated Circuit (I<sup>2</sup>C) Interface</b>															
<b>I<sup>2</sup>C Master</b>															
I2C Master 0 base: 0x4002.0000															
I2C Master 1 base: 0x4002.1000															
<b>I2CMSA, type R/W, offset 0x000, reset 0x0000.0000</b>															
												SA		R/S	
<b>I2CMCS, type RO, offset 0x004, reset 0x0000.0000</b>															
								BUSBSY	IDLE	ARBLST	DATAACK	ADRACK	ERROR	BUSY	
<b>I2CMCS, type WO, offset 0x004, reset 0x0000.0000</b>															
												ACK	STOP	START	RUN
<b>I2CMDR, type R/W, offset 0x008, reset 0x0000.0000</b>															
												DATA			
<b>I2CMTPR, type R/W, offset 0x00C, reset 0x0000.0001</b>															
												TPR			
<b>I2CMIMR, type R/W, offset 0x010, reset 0x0000.0000</b>															
														IM	
<b>I2CMRIS, type RO, offset 0x014, reset 0x0000.0000</b>															
														RIS	
<b>I2CMMIS, type RO, offset 0x018, reset 0x0000.0000</b>															
														MIS	
<b>I2CMICR, type WO, offset 0x01C, reset 0x0000.0000</b>															
														IC	

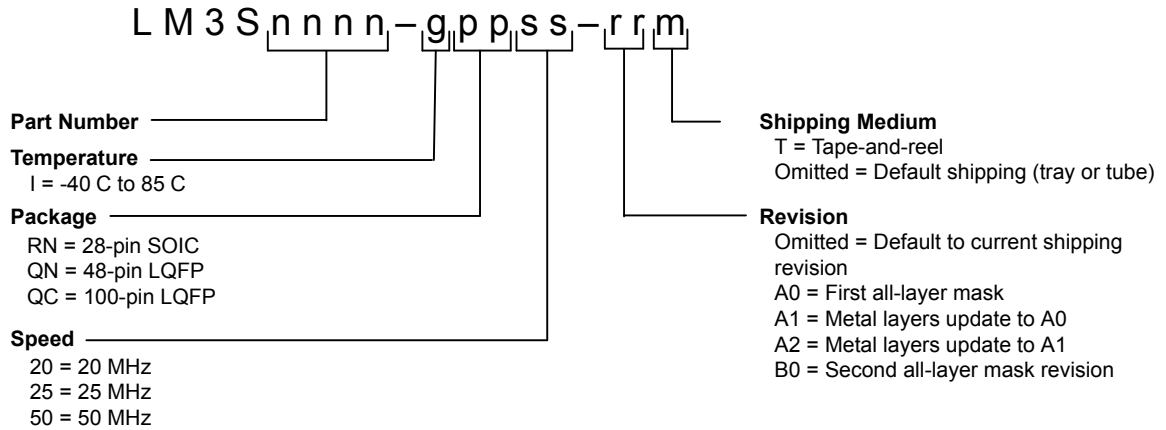
31	30	29	28	27	26	25	24	23	22	21	20	19	18	17	16
15	14	13	12	11	10	9	8	7	6	5	4	3	2	1	0
<b>I2CMCR, type R/W, offset 0x020, reset 0x0000.0000</b>															
											SFE	MFE			LPBK
<b>Inter-Integrated Circuit (I<sup>2</sup>C) Interface</b>															
<b>I<sup>2</sup>C Slave</b>															
I2C Slave 0 base: 0x4002.0800															
I2C Slave 1 base: 0x4002.1800															
<b>I2CSOAR, type R/W, offset 0x000, reset 0x0000.0000</b>															
													OAR		
<b>I2CCSR, type RO, offset 0x004, reset 0x0000.0000</b>															
													FBR	TREQ	RREQ
<b>I2CCSR, type WO, offset 0x004, reset 0x0000.0000</b>															
															DA
<b>I2CSDR, type R/W, offset 0x008, reset 0x0000.0000</b>															
															DATA
<b>I2CSIMR, type R/W, offset 0x00C, reset 0x0000.0000</b>															
															IM
<b>I2CSRIS, type RO, offset 0x010, reset 0x0000.0000</b>															
															RIS
<b>I2CSMIS, type RO, offset 0x014, reset 0x0000.0000</b>															
															MIS
<b>I2CSICR, type WO, offset 0x018, reset 0x0000.0000</b>															
															IC
<b>Analog Comparators</b>															
Base 0x4003.C000															
<b>ACMIS, type R/W1C, offset 0x00, reset 0x0000.0000</b>															
													IN2	IN1	IN0
<b>ACRIS, type RO, offset 0x04, reset 0x0000.0000</b>															
													IN2	IN1	IN0
<b>ACINTEN, type R/W, offset 0x08, reset 0x0000.0000</b>															
													IN2	IN1	IN0
<b>ACREFCTL, type R/W, offset 0x10, reset 0x0000.0000</b>															
						EN	RNG								VREF
<b>ACSTAT0, type RO, offset 0x20, reset 0x0000.0000</b>															
														OVAL	
<b>ACSTAT1, type RO, offset 0x40, reset 0x0000.0000</b>															
														OVAL	

31	30	29	28	27	26	25	24	23	22	21	20	19	18	17	16
15	14	13	12	11	10	9	8	7	6	5	4	3	2	1	0
<b>ACSTAT2, type RO, offset 0x60, reset 0x0000.0000</b>															
														OVAL	
<b>ACCTL0, type R/W, offset 0x24, reset 0x0000.0000</b>															
				TOEN	ASRCP			TSLVAL	TSEN	ISLVAL		ISEN	CINV		
<b>ACCTL1, type R/W, offset 0x44, reset 0x0000.0000</b>															
				TOEN	ASRCP			TSLVAL	TSEN	ISLVAL		ISEN	CINV		
<b>ACCTL2, type R/W, offset 0x64, reset 0x0000.0000</b>															
				TOEN	ASRCP			TSLVAL	TSEN	ISLVAL		ISEN	CINV		



## C Ordering and Contact Information

### C.1 Ordering Information



**Table C-1. Part Ordering Information**

Orderable Part Number	Description
LM3S1138-IQC50	Stellaris® LM3S1138 Microcontroller
LM3S1138-IQC50(T)	Stellaris® LM3S1138 Microcontroller

### C.2 Company Information

Luminary Micro, Inc. designs, markets, and sells ARM Cortex-M3-based microcontrollers (MCUs). Austin, Texas-based Luminary Micro is the lead partner for the Cortex-M3 processor, delivering the world's first silicon implementation of the Cortex-M3 processor. Luminary Micro's introduction of the Stellaris® family of products provides 32-bit performance for the same price as current 8- and 16-bit microcontroller designs. With entry-level pricing at \$1.00 for an ARM technology-based MCU, Luminary Micro's Stellaris product line allows for standardization that eliminates future architectural upgrades or software tool changes.

Luminary Micro, Inc.  
108 Wild Basin, Suite 350  
Austin, TX 78746  
Main: +1-512-279-8800  
Fax: +1-512-279-8879  
<http://www.luminarymicro.com>  
[sales@luminarymicro.com](mailto:sales@luminarymicro.com)

### C.3 Support Information

For support on Luminary Micro products, contact:  
[support@luminarymicro.com](mailto:support@luminarymicro.com) +1-512-279-8800, ext. 3