

GSF-72 21S30B

21.4MHz 4 pole crystal filter with 30.0kHz 3dB bandwidth

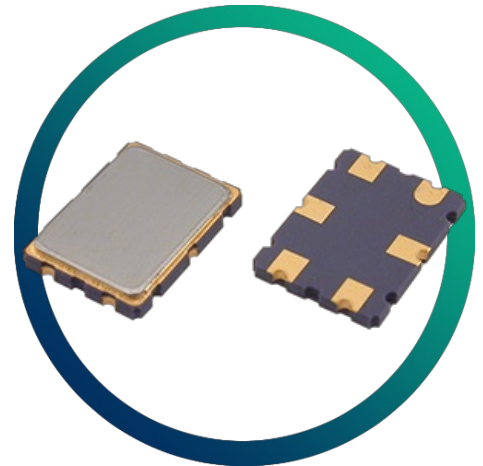

- Other frequencies up to 70MHz available
- Custom specifications available
- Miniature SM package

CONFIGURABLE OPTIONS

Parameter

Option Code

The GSF-72 21S30B has no configurable options.

Please see the specifications table for more details or contact our team today if you have other specification requirements.

SPECIFICATIONS

Centre frequency	21.4MHz
Dimensions	7.2 x 5.2 x 1.2mm
Operating temperature range	-20 to +70°C
Number of poles	4
Pass band	-3dB @ ±15.0kHz min
Attenuation band	-35dB @ ±50.0kHz max
In-band ripple	1.0dB max
Insertion loss	2.5dB max
Guaranteed attenuation	-80dB max -910 ±10kHz
Termination	3000Ω // -1.5pF
Coupling capacitance (C _C)	3.0pF
Number of units	2

PACKAGE DRAWING

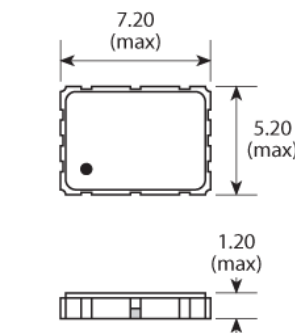

PAD	CONNECTION
1	Ground
2	Not connected
3	In / Out
4	Ground
5	Not connected
6	Out / In

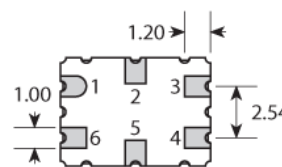

SOLDER PAD LAYOUT

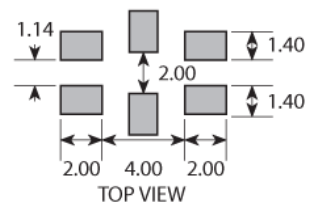

Dimensions in mm

ORDERING INFORMATION

To request a quotation for the GSF-72 21S30B please use the configurable options form to choose the options you require and then submit your configured product to our team. Our expert advisers are always happy to help with your requirements and can be contacted on +44 1460 256 100 or at sales@golledge.com.

Following product selection you will be issued with a seven character Golledge part number. Your Golledge part number is the internationally accepted Golledge manufacturing part number (MPN) that should be used for all project documentation, including bills of materials (BoMs) and purchase orders.

If you have any queries regarding any of our documentation our dedicated sales team will be happy to help.

SOLDERING PROFILE

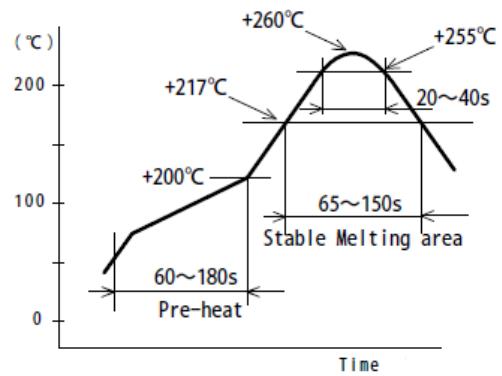

TAPE & REEL SPECIFICATION

HANDLING & STORAGE

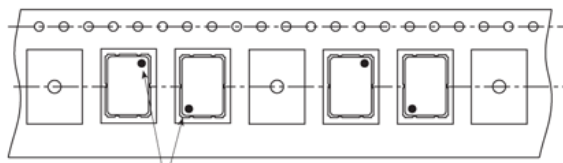
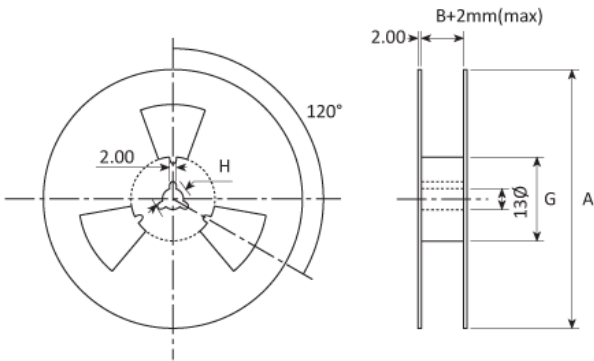
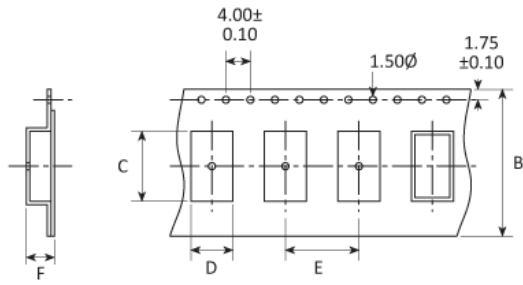

Connection marks
Dimensions in mm
Not to scale

A:250 B:17.5 C:7.9 D:5.4 E:8 F:1.7 G:80 H:21



Human Body Model (HBM) 1A (250V to <500V)





Moisture Sensitivity Level (MSL): 1 (or not applicable)

CONSTRUCTION

Ceramic base with metal lid

MATERIAL COMPOSITION

 Lead-free (< 0.1% by weight)

 RoHS 2 compliant with no exemptions. [See our declaration](#)

 REACH compliant. [See our statement](#)

 Free of conflict minerals. [See our declaration](#)

 Free of Halogens. [See our declaration](#)

 Free of Ozone-depleting substances. [See our declaration](#)

OTHER INFORMATION

About Golledge

We are the UK's leading supplier of frequency control products and are proud to serve the global electronics industry. Our philosophy is a focus firmly on your requirements by striving to meet and exceed your needs. We do this by ensuring the utmost quality and consistency in our products and services. If you have any queries about the Golledge service or any of our products please get in touch, we'd love to hear from you.

Come and visit

Eaglewood Park, ILMINSTER,
Somerset, TA19 9DQ, England

Give us a call

Tel: +44 1460 256 100
Fax: +44 1460 256 101

Email us

sales@golledge.com

Our Worldwide Distributors

Belgium & Luxembourg

Alcom Electronics NV/SA



Email info@alcom.be
Web www.alcom.be
Tel +32 (0)3 458.30.33

China, Hong Kong - 中国 / 香港

Meiya China



Email sales@meiyatech.com
Web www.meiyatech.com
Tel +86 755 2823 1923

France

Equipments Scientifique



Email comp@es-france.com
Web www.es-france.com
Tel +33 1 47 95 99 89

Germany

MEV Elektronik Service GmbH



Email info@mev-elektronik.com
Web www.mev-elektronik.com
Tel +49 54 24 23 40-0

India

V5 Semiconductors



Email sales@v5semiconductors.com
Web v5semiconductors.com
Tel +91-80-2661 0621

Israel

Phoenix Technologies Ltd



Email sales@phnx.co.il
Web www.phnx.co.il
Tel +972 9 764 4800

Netherlands

Alcom Electronics BV



Email info@alcom.nl
Web alcom.nl
Tel +31 (0)10 288.25.00

Norway

Link Nordic



Email bjorn.nyjordet@linknordic.com
Web linknordic.com
Tel +47 93 22 68 90

Russia - Россия

EFO Ltd



Email elena@efo.ru
Web www.golledge.ru
Tel +7(812)327-8654

Spain & Portugal

R.C. Microelectronica, S.A.



Email ventas@rcmicro.es
Web www.rcmicro.es
Tel +34 93 260 21 66

Our customer feedback is testament to our quality; "Never had such good service as this from anyone in 35 years of being in the industry, this is impressive and has really helped us out of a corner to keep the design flowing" Andy (Senior Design Engineer), "As always your support is state of the art" Nicoleta (Material Management), "Legendary work - as usual it has to be said" John (Operations).

To take advantage of our highly praised service get in touch with us today.