

## TO-92 Plastic-Encapsulate Transistors

### FEATURES

- Switching and Amplification in High Voltage
- Applications such as Telephony
- Low Current
- High Voltage
- PNP Transistors

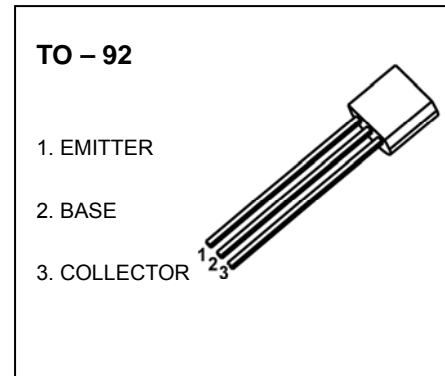

### MAXIMUM RATINGS ( $T_a=25^\circ\text{C}$ unless otherwise noted)

Symbol	Parameter	Value	Unit
$V_{CBO}$	Collector-Base Voltage	-160	V
$V_{CEO}$	Collector-Emitter Voltage	-150	V
$V_{EBO}$	Emitter-Base Voltage	-5	V
$I_C$	Collector Current	-0.6	A
$P_C$	Collector Power Dissipation	625	mW
$R_{\theta JA}$	Thermal Resistance From Junction To Ambient	200	$^\circ\text{C}/\text{W}$
$T_j$	Junction Temperature	150	$^\circ\text{C}$
$T_{stg}$	Storage Temperature	-55~+150	$^\circ\text{C}$

### ELECTRICAL CHARACTERISTICS ( $T_a=25^\circ\text{C}$ unless otherwise specified)

Parameter	Symbol	Test conditions	Min	Typ	Max	Unit
Collector-base breakdown voltage	$V_{(BR)CBO}$	$I_C = -0.1\text{mA}, I_E = 0$	-160			V
Collector-emitter breakdown voltage	$V_{(BR)CEO}$	$I_C = -1\text{mA}, I_B = 0$	-150			V
Emitter-base breakdown voltage	$V_{(BR)EBO}$	$I_E = -0.01\text{mA}, I_C = 0$	-5			V
Collector cut-off current	$I_{CBO}$	$V_{CB} = -120\text{V}, I_E = 0$			-50	nA
Emitter cut-off current	$I_{EBO}$	$V_{EB} = -3\text{V}, I_C = 0$			-50	nA
DC current gain	$h_{FE(1)}$	$V_{CE} = -5\text{V}, I_C = -1\text{mA}$	80			
	$h_{FE(2)}$	$V_{CE} = -5\text{V}, I_C = -10\text{mA}$	60		300	
	$h_{FE(3)}$	$V_{CE} = -5\text{V}, I_C = -50\text{mA}$	50			
Collector-emitter saturation voltage	$V_{CE(sat)}$	$I_C = -50\text{mA}, I_B = -5\text{mA}$			-0.5	V
Base-emitter saturation voltage	$V_{BE(sat)}$	$I_C = -50\text{mA}, I_B = -5\text{mA}$			-1	V
Transition frequency	$f_T$	$V_{CE} = -5\text{V}, I_C = -10\text{mA}, f = 30\text{MHz}$	100		300	MHz

\*Pulse test: pulse width  $\leq 300\mu\text{s}$ , duty cycles  $\leq 2.0\%$ .

## Typical Characteristics

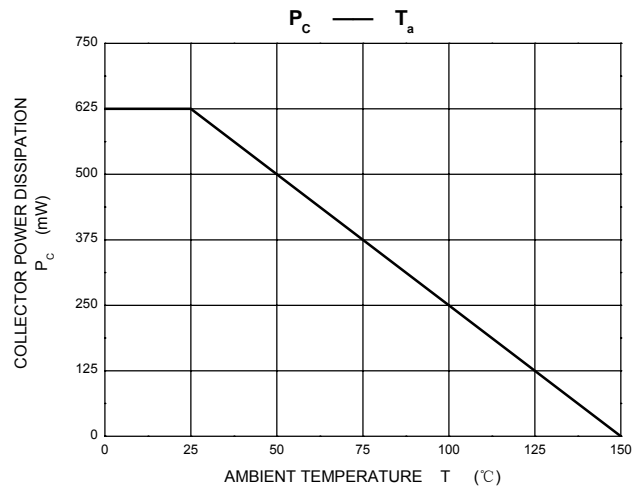
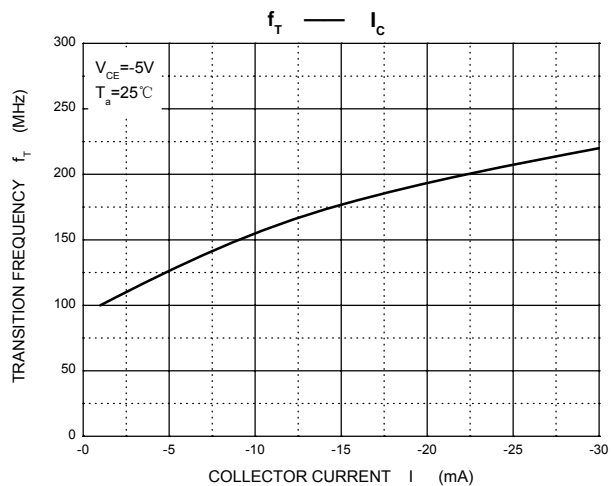
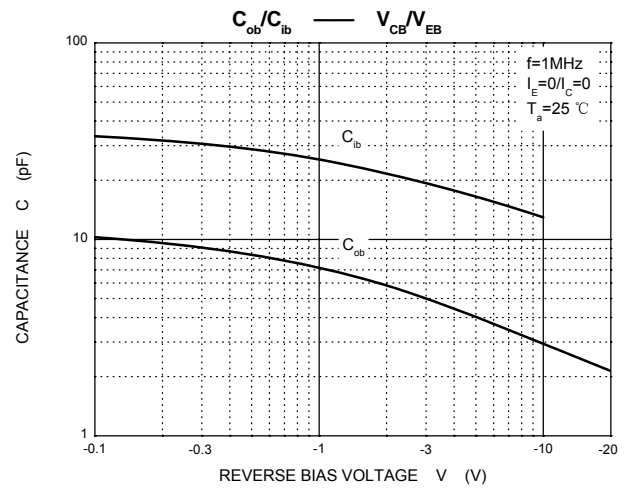
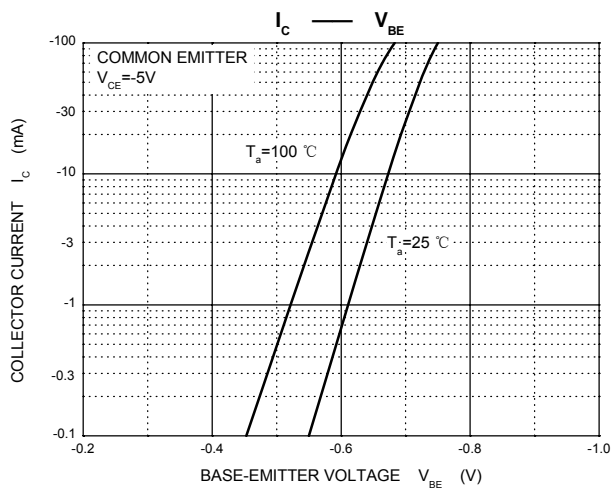
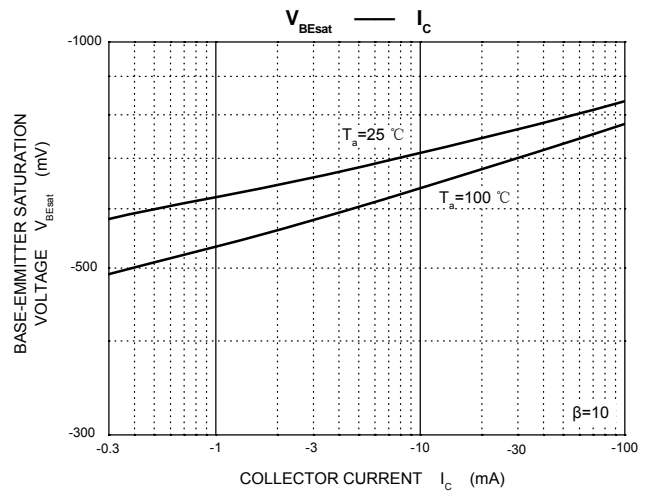
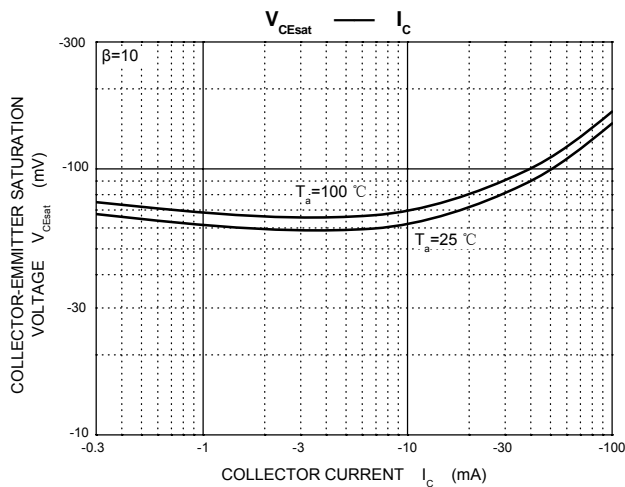
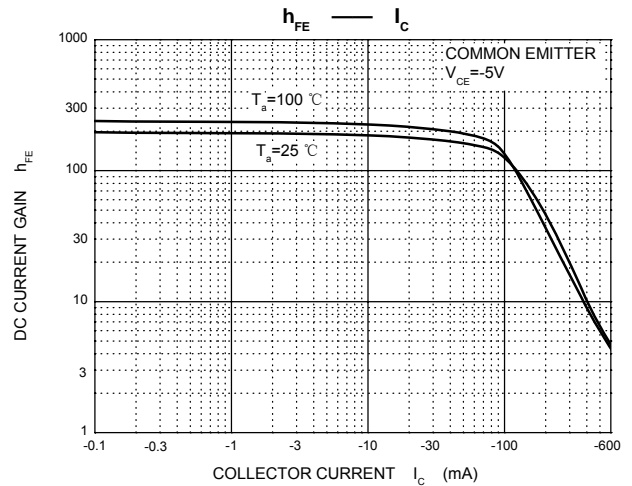
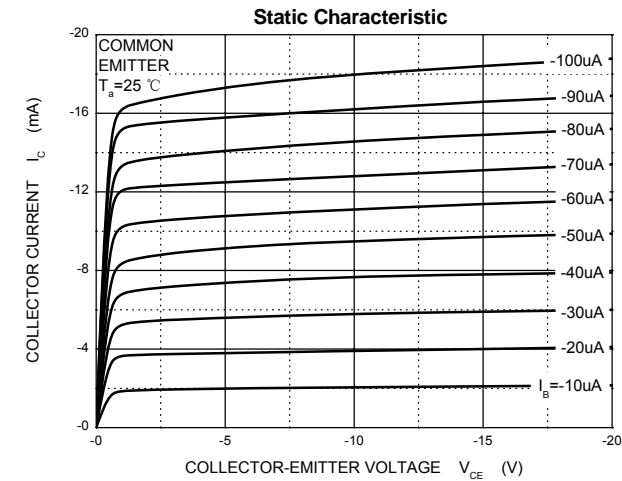

**TO-92 Package Outline Dimensions**

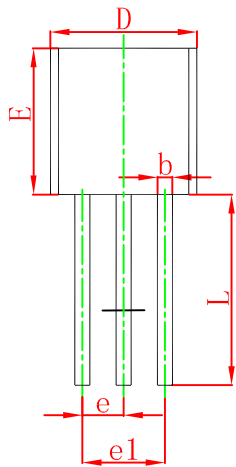
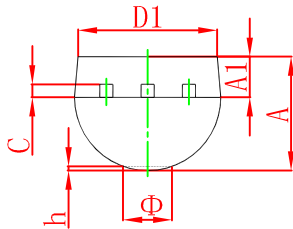

Symbol	Dimensions In Millimeters		Dimensions In Inches	
	Min	Max	Min	Max
A	3.300	3.700	0.130	0.146
A1	1.100	1.400	0.043	0.055
b	0.380	0.550	0.015	0.022
c	0.360	0.510	0.014	0.020
D	4.300	4.700	0.169	0.185
D1	3.430		0.135	
E	4.300	4.700	0.169	0.185
e	1.270 TYP		0.050 TYP	
e1	2.440	2.640	0.096	0.104
L	14.100	14.500	0.555	0.571
Φ		1.600		0.063
h	0.000	0.380	0.000	0.015

**TO-92 Suggested Pad Layout**

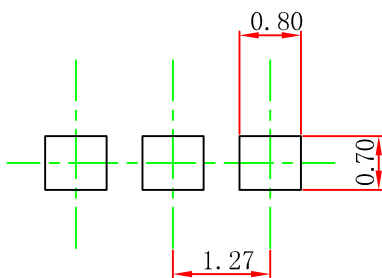

**Note:**

1. Controlling dimension: in millimeters.
2. General tolerance: ± 0.05mm.
3. The pad layout is for reference purposes only.