



FEATURES

- 30 WATTS OUTPUT POWER
- OUTPUT CURRENT UP TO 8.5A
- STANDARD 2.00 X 1.00 X 0.40 INCH
- HIGH EFFICIENCY UP TO 91%
- 4:1 ULTRA WIDE INPUT VOLTAGE RANGE
- SIX-SIDED CONTINUOUS SHIELD
- FIXED SWITCHING FREQUENCY
- CE MARK MEETS 2006/95/EC, 93/68/EEC AND 89/336 EEC
- DESIGN MEETS UL60950-1, EN60950-1 AND IEC60950-1
- ISO9001 CERTIFIED MANUFACTURING FACILITIES
- COMPLIANT TO RoHS EU DIRECTIVE 2002/95/EC

OPTIONS

Negative logic Remote On/Off

DESCRIPTION

The FED30W series offer 30 watts of output power from a 2 x 1 x 0.4 inch package. FED30W series have 4:1 ultra wide input voltage of 9-36 and 18-75VDC. The FED30W have features 1600VDC of isolation, short circuit protection, over-current protection, over-voltage protection, over-temperature protection and six sided shielding.

APPLICATIONS

Wireless Network
Telecom/Datacom
Industry Control System
Measurement
Semiconductor Equipment

TECHNICAL SPECIFICATION

All specifications are typical at nominal input, full load and 25°C otherwise noted

OUTPUT SPECIFICATIONS		INPUT SPECIFICATIONS	
Output power	30 Watts max.	Input voltage range	24V nominal input 9 – 36VDC 48V nominal input 18 – 75VDC
Voltage accuracy	Full load and nominal Vin ±1%	Input filter	Pi type
Voltage adjustability	Single output ± 10%	Input surge voltage	24V input 50VDC 100mS max 48V input 100VDC
Minimum load	0%	Input reflected ripple current	Nominal Vin and full load 20mA _{p-p}
Line regulation	LL to HL at Full Load ± 0.2%	Start up time	Nominal Vin and constant resistive load Power up 30mS, typ. Remote ON/OFF 30mS, typ.
Load regulation	No load to Full load Single ± 0.5% Dual ± 1%	Start-up voltage	24V input 9VDC 48V input 18VDC
Cross regulation (Dual)	Asymmetrical load 25% / 100% FL ± 5%	Shutdown voltage	24V input 8VDC 48V input 16VDC
Ripple and noise	20MHz bandwidth 1.5-5.1Vo 100mV _{p-p} (Measured with a 1uF/50V MLCC) 12-15Vo 150mV _{p-p}	Remote ON/OFF (Note 6)	(Positive logic)(Standard) DC-DC ON Open or 3V < Vr < 12V DC-DC OFF Short or 0V < Vr < 1.2V (Negative logic)(Option) DC-DC ON Short or 0V < Vr < 1.2V DC-DC OFF Open or 3V < Vr < 12V
Temperature coefficient	±0.02% / °C, max.	Input current of Remote control pin	Nominal Vin -0.5mA ~ +0.5mA
Transient response recovery time	25% load step change 250µS	Remote off state input current	Nominal Vin 3mA
Over voltage protection	1.5V Output 2.0V 2.5V Output 3.3V 3.3V Output 3.9V	ENVIRONMENTAL SPECIFICATIONS	
Zener diode clamp	5.0V & 5.1V & ±5V Output 6.2V 12V & ±12V Output 15V 15V & ±15V Output 18V	Operating ambient temperature	-40°C to +50°C (without derating) +50°C to +85°C (with derating)
Over load protection	% of FL at nominal input 150%, typ.	Maximum case temperature	105°C
Short circuit protection	Hiccup, automatics recovery	Storage temperature range	-55°C to +125°C
GENERAL SPECIFICATIONS		Over temperature protection	115°C, typ
Efficiency	See table	Thermal impedance	Nature convection 12°C/Watt (Note 7) Nature convection with heat-sink 10°C/Watt
Isolation voltage	Input to Output 1600VDC, min. Input (Output) to Case 1600VDC, min.	Thermal shock	MIL-STD-810F
Case grounding	Connect case to -Vin with decoupling Y Cap	Vibration	MIL-STD-810F
Isolation resistance	10 ⁹ ohms, min.	Relative humidity	5% to 95% RH
Isolation capacitance	1500pF, max.	EMC CHARACTERISTICS	
Switching frequency	430KHz, typ.	EMI (Note 8)	EN55022 Class A
Design meets safety standard	IEC60950-1, UL60950-1, EN60950-1	ESD	EN61000-4-2 Air ± 8KV Perf. Criteria A Contact ± 6KV
Case material	Nickel-coated copper	Radiated immunity	EN61000-4-3 10 V/m Perf. Criteria A
Base material	FR4 PCB	Fast transient (Note 9)	EN61000-4-4 ± 2KV Perf. Criteria A
Potting material	Epoxy (UL94-V0)	Surge (Note 9)	EN61000-4-5 ± 1KV Perf. Criteria A
Dimensions	2.00 X 1.00 X 0.40 Inch (50.8X 25.4 X 10.2 mm)	Conducted immunity	EN61000-4-6 10 Vr.m.s Perf. Criteria A
Weight	30.5g(1.07oz)		
MTBF (Note 1)	BELLCORE-TR-NWT-000332 3.163 x 10 ⁶ hrs. MIL-HDBK-217F 4.347 x 10 ⁵ hrs.		





Model Number	Input Range	Output Voltage	Output Current		Output ⁽⁴⁾ Ripple & Noise	Input Current		Eff ⁽⁴⁾ (%)	Capacitor ⁽⁵⁾ Load max.
			Min. Load	Max. Load		No load ⁽³⁾	Full Load ⁽²⁾		
FED30-24S1P5W	9 – 36 VDC	1.5 VDC	0mA	8500mA	100mVp-p	70mA	700mA	80	20000µF
FED30-24S2P5W	9 – 36 VDC	2.5 VDC	0mA	8000mA	100mVp-p	70mA	1054mA	83	20000µF
FED30-24S3P3W	9 – 36 VDC	3.3 VDC	0mA	7500mA	100mVp-p	70mA	1258mA	86	20000µF
FED30-24S05W	9 – 36 VDC	5.0 VDC	0mA	6000mA	100mVp-p	105mA	1488mA	88	14400µF
FED30-24S5P1W	9 – 36 VDC	5.1 VDC	0mA	6000mA	100mVp-p	105mA	1517mA	88	14400µF
FED30-24S12W	9 – 36 VDC	12 VDC	0mA	2500mA	150mVp-p	20mA	1471mA	89	3000µF
FED30-24S15W	9 – 36 VDC	15 VDC	0mA	2000mA	150mVp-p	30mA	1471mA	89	2000µF
FED30-24D05W	9 – 36 VDC	±5VDC	0mA	±3000mA	100mVp-p	90mA	1488mA	88	± 3000µF
FED30-24D12W	9 – 36 VDC	±12VDC	0mA	±1250mA	150mVp-p	25mA	1506mA	87	± 2000µF
FED30-24D15W	9 – 36 VDC	±15VDC	0mA	±1000mA	150mVp-p	25mA	1506mA	87	± 1300µF
FED30-48S1P5W	18 – 75 VDC	1.5 VDC	0mA	8500mA	100mVp-p	30mA	350mA	80	20000µF
FED30-48S2P5W	18 – 75 VDC	2.5 VDC	0mA	8000mA	100mVp-p	45mA	520mA	84	20000µF
FED30-48S3P3W	18 – 75 VDC	3.3 VDC	0mA	7500mA	100mVp-p	45mA	629mA	86	20000µF
FED30-48S05W	18 – 75 VDC	5.0 VDC	0mA	6000mA	100mVp-p	65mA	744mA	88	14400µF
FED30-48S5P1W	18 – 75 VDC	5.1 VDC	0mA	6000mA	100mVp-p	65mA	759mA	88	14400µF
FED30-48S12W	18 – 75 VDC	12 VDC	0mA	2500mA	150mVp-p	60mA	727mA	90	3000µF
FED30-48S15W	18 – 75 VDC	15 VDC	0mA	2000mA	150mVp-p	50mA	718mA	91	2000µF
FED30-48D05W	18 – 75 VDC	±5VDC	0mA	±3000mA	100mVp-p	50mA	744mA	88	± 3000µF
FED30-48D12W	18 – 75 VDC	±12VDC	0mA	±1250mA	150mVp-p	15mA	744mA	88	± 2000µF
FED30-48D15W	18 – 75 VDC	±15VDC	0mA	±1000mA	150mVp-p	15mA	744mA	88	± 1300µF

Note

- BELLCORE TR-NWT-000332. Case I: 50% Stress, Temperature at 40°C. (Ground fixed and controlled environment)
MIL-STD-217F Notice2 @Ta=25 °C, Full load (Ground, Benign, controlled environment)
- Maximum value at nominal input voltage.
- Typical value at nominal input voltage and no load.
- Typical value at nominal input voltage and full load.
- Test by minimum Vin and constant resistive load.
- The ON/OFF control pin voltage is referenced to -Input.
- Heat sink is optional and P/N: 7G-0020C-F.
- The FED30W series can meet EN55022 Class A with parallel an external capacitor to the input pins.
Recommend: 24Vin : 4.7µF/50V X7R 1812 MLCC.
48Vin : 2.2µF/100V X7R 1812 MLCC.
- An external filter capacitor is required if the module has to meet EN61000-4-4, EN61000-4-5.
The filter capacitor Power Mate suggest: 24Vin : Nippon chemi-con KY series, 330µF/50V, ESR 55mΩ.
48Vin : Nippon chemi-con KY series, 220µF/100V, ESR 48mΩ

FED30-48S05W Derating Curve

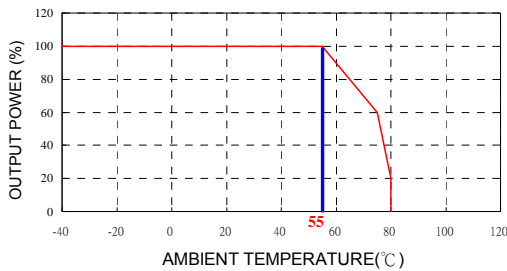

FED30-48S05W Derating Curve with Heat-Sink

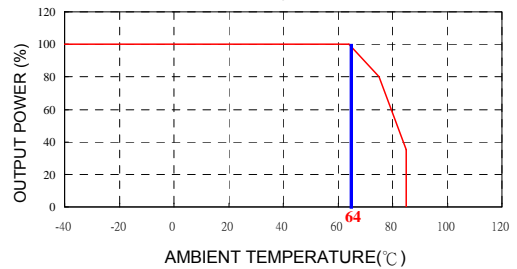

FED30-48S05W Efficiency VS Input voltage

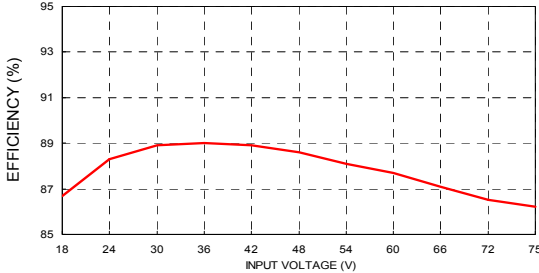

FED30-48S05W Efficiency VS Output Load

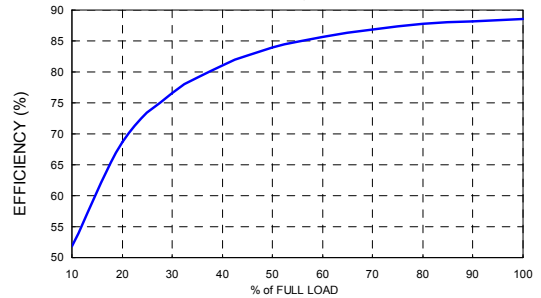

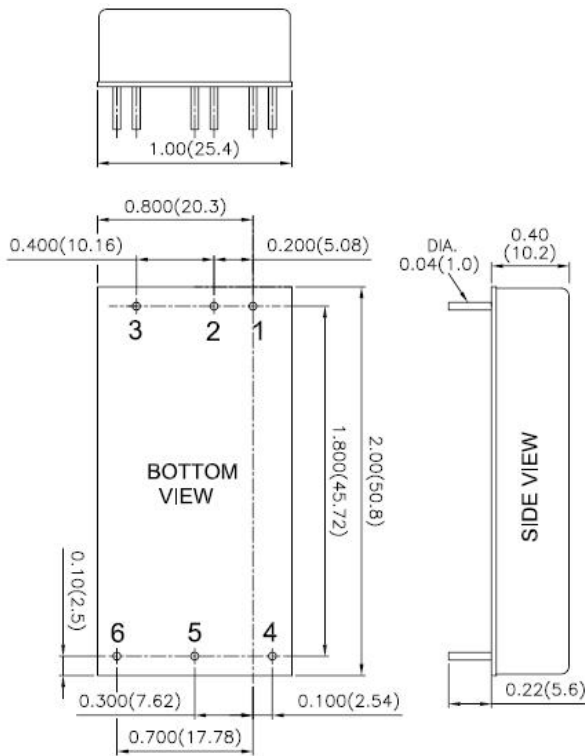

- All dimensions in Inches (mm)
Tolerance: X.XX±0.02 (X.X±0.5)
X.XXX±0.01 (X.XX±0.25)
- Pin pitch tolerance ±0.01(0.25)
- Pin dimension tolerance ±0.004 (0.1)

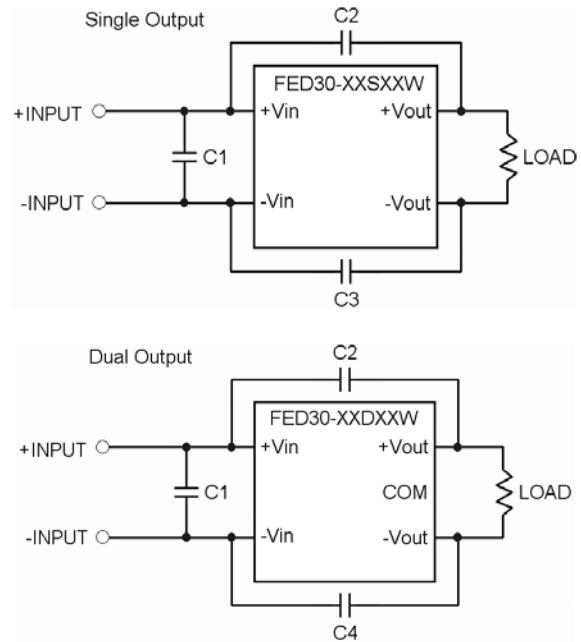

Recommended Filter for EN55022 Class A Compliance

The components used in the above figure, together with the manufacturers' part numbers for these components, are as follows:

Single Output	C1	C2 & C3
FED30-24S XX W	6.8µF/50V 1812 MLCC	1000pF/2KV 1808 MLCC
FED30-48S XX W	2.2µF/100V 1812 MLCC	1000pF/2KV 1808 MLCC

Dual Output	C1	C2 & C4
FED30-24D XX W	6.8µF/50V 1812 MLCC	1000pF/2KV 1808 MLCC
FED30-48D XX W	2.2µF/100V 1812 MLCC	1000pF/2KV 1808 MLCC

PIN CONNECTION		
PIN	SINGLE	DUAL
1	+ INPUT	+ INPUT
2	- INPUT	- INPUT
3	CTRL	CTRL
4	+ OUTPUT	+ OUTPUT
5	- OUTPUT	COMMON
6	TRIM	- OUTPUT

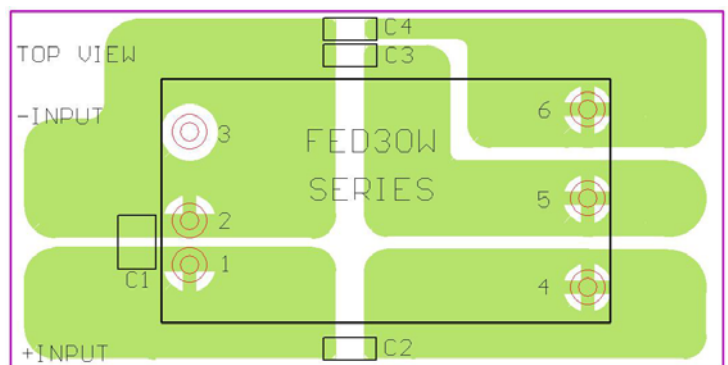
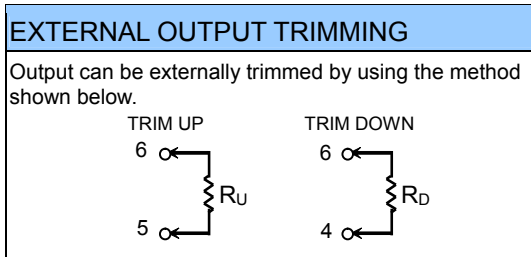

Recommended EN55022 Class A Filter Circuit Layout

